

AQUADREAM

Aquarium Assembly Instructions

- *AD-1060 WS
- *AD-1260 WS/SILVER
- *AD-1560 SILVER
- *AD-1560 WS
- *AD-1760 WS
- *AD-1980 WS
- *AD-2320 BP



AQUADREAM®

Aquarium Assembly Instructions

- *AD-1060 WS *AD-1260 WS/SILVER
- *AD-1560 SILVER *AD-1560 WS
- *AD-1760 WS *AD-1980 WS
- *AD-2320 BP

Diagram 1:

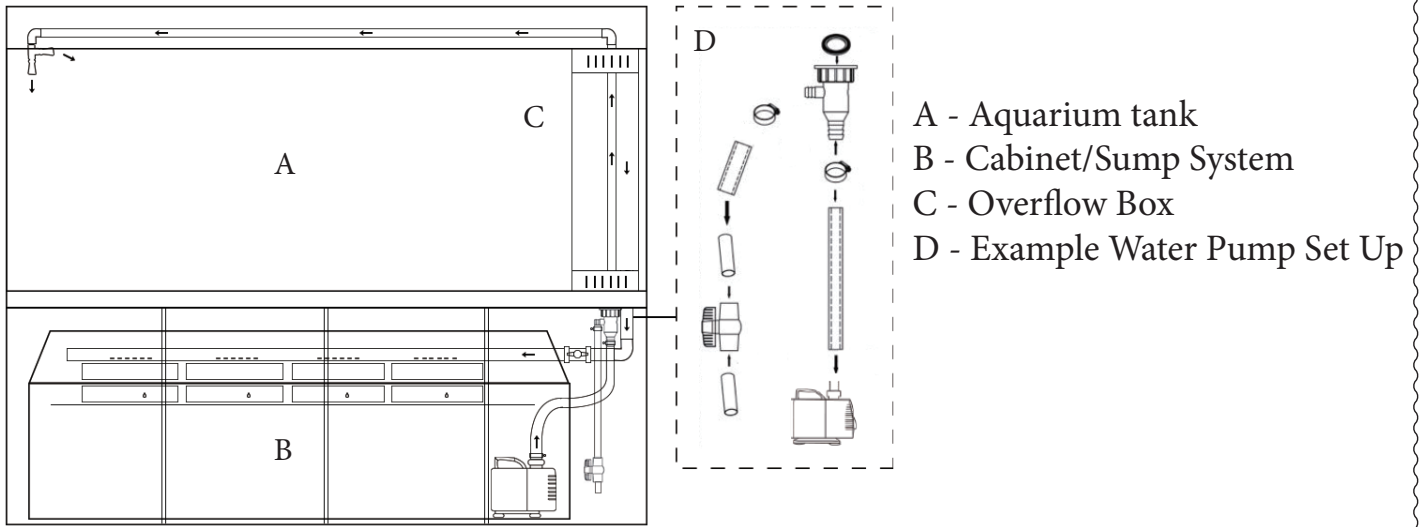
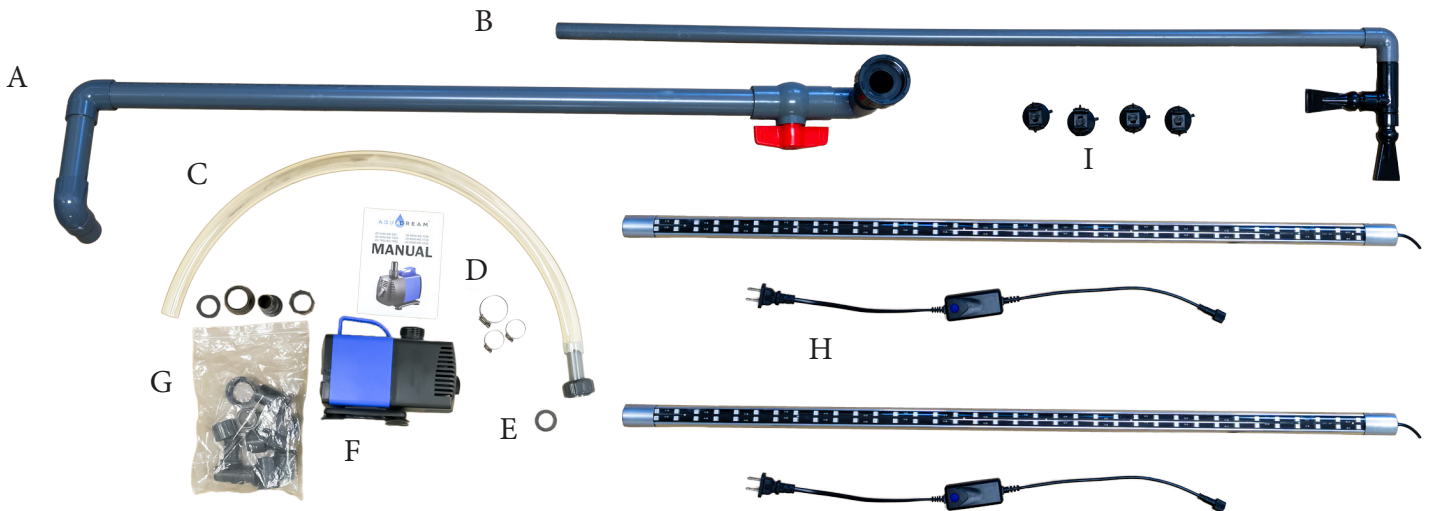

Diagram 2:



- A - Outflow Pipe
- B - Inlet Pipe
- C - Inlet Hose
- D - O-Rings
- E - Rubber Gasket
- F - Water Pump
- G - Pump Outlet Parts
- H - LED Lamps and Power Adapters
- I - LED Lamp Suction Cups

1 - Attach the outflow pipe to the underside of the tank. Be sure to guide the pipe end into the guide hole at the top of the filter box before tightening it down. [fig. 1 and fig. 2]



fig. 1

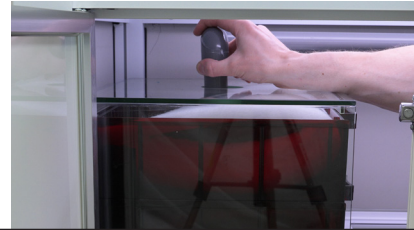

fig. 2

2 - Locate the Outlet Valve Hose [fig.3]

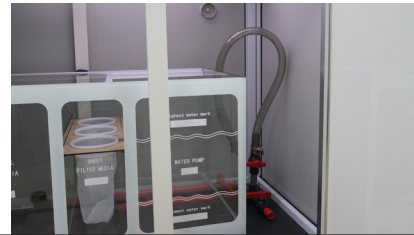

fig. 3

3 - Insert the rubber gasket inside the end of the outlet valve hose, then attach the outlet valve hose to the underside of the tank. [fig. 4, fig. 5, fig. 6]



fig. 4



fig. 5

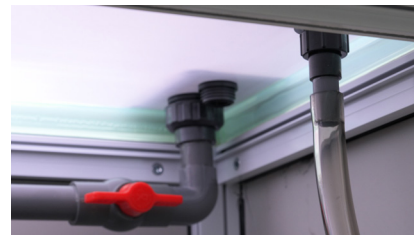

fig. 6

4 - Use a Philips head screwdriver to tighten the O-ring clamps at both ends of the Outlet Valve Hose [fig. 7 and fig. 8]



fig. 7



fig. 8

5 - Locate the included pump and accessories [fig. 9]



fig. 9

6 - Slide the two metal O-ring clamps onto the inlet hose [fig.10]



fig. 10

7 - Assemble the outlet that corresponds to the inlet hose diameter, using an outlet and locking nuts [fig. 11, fig. 12, and fig. 13]



fig. 11



fig. 12



fig.13

8 - Install the rubber gasket inside the end of the inlet hose and attach it to the pump. [fig. 14 and fig. 15]



fig. 14



fig. 15



fig. 16



fig. 17



fig. 18

9 - Tighten the metal O-ring clamps onto both ends of the hose and lower the water pump into the marked Water Pump bay in the filtration system [fig. 16, fig.17, fig. 18]



fig. 19

10 - Install the rubber gasket in the end of the inlet hose and attach it to the underside of the tank [fig.19 and fig. 20]



fig.20



fig. 21

11 - Feed the pump's power cable through the hole in the back of the tank [fig. 21]

12 - Filter Media Example Set up
Prepared filter media [fig. 22]

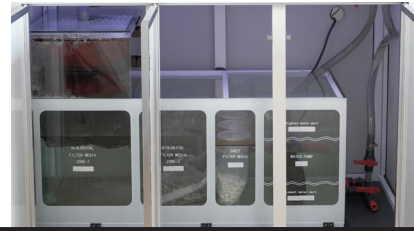

fig. 22

13 - Gently lift the outflow pipe out of the guide hole in the top of the red filter box and remove the drawers [fig. 23 and fig. 24]

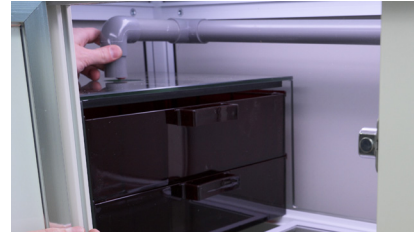

fig. 23



fig. 24

14 - Add filter media to Zone 1
(bio balls pictured) [fig. 25]



fig. 25

15 - Add filter media to filter box drawers
(sheet media pictured) [fig. 26]



fig. 26

16 - Close filter box drawers and reposition the outflow pipe into the guide hole at the top [fig. 27]

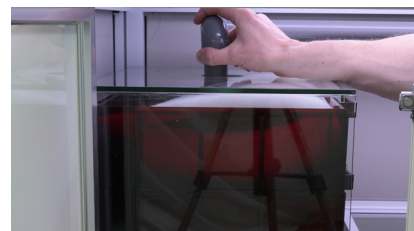

fig. 27

17 - Add filter media to Zone 2
(coral pictured) [fig. 28]



fig. 28

18 - Add filter media to basket filters
(ceramic rings pictured) [fig. 29 and fig. 30]



fig. 29



fig. 30

19 - Install the glass cover to the sump system [fig. 31]



fig. 31

20 - On the top of the tank, connect the inflow pipe
to the elbow at the top of the overflow box [fig. 32]



fig. 32

Aqua Dream Contact Information

- Address: 3125 Mercer Ave Ste 104 & 103, Bellingham, WA 98225
- Phone: (360) 223-4997
(360) 510-7754
>> 24/7 Technical Assistance <<
- Website: www.AquaDreamUSA.com
- Email: sales@aquadreamusa.com
wholesale@tigermountainindustrial.com

