

Configurations ★ Popular Configuration

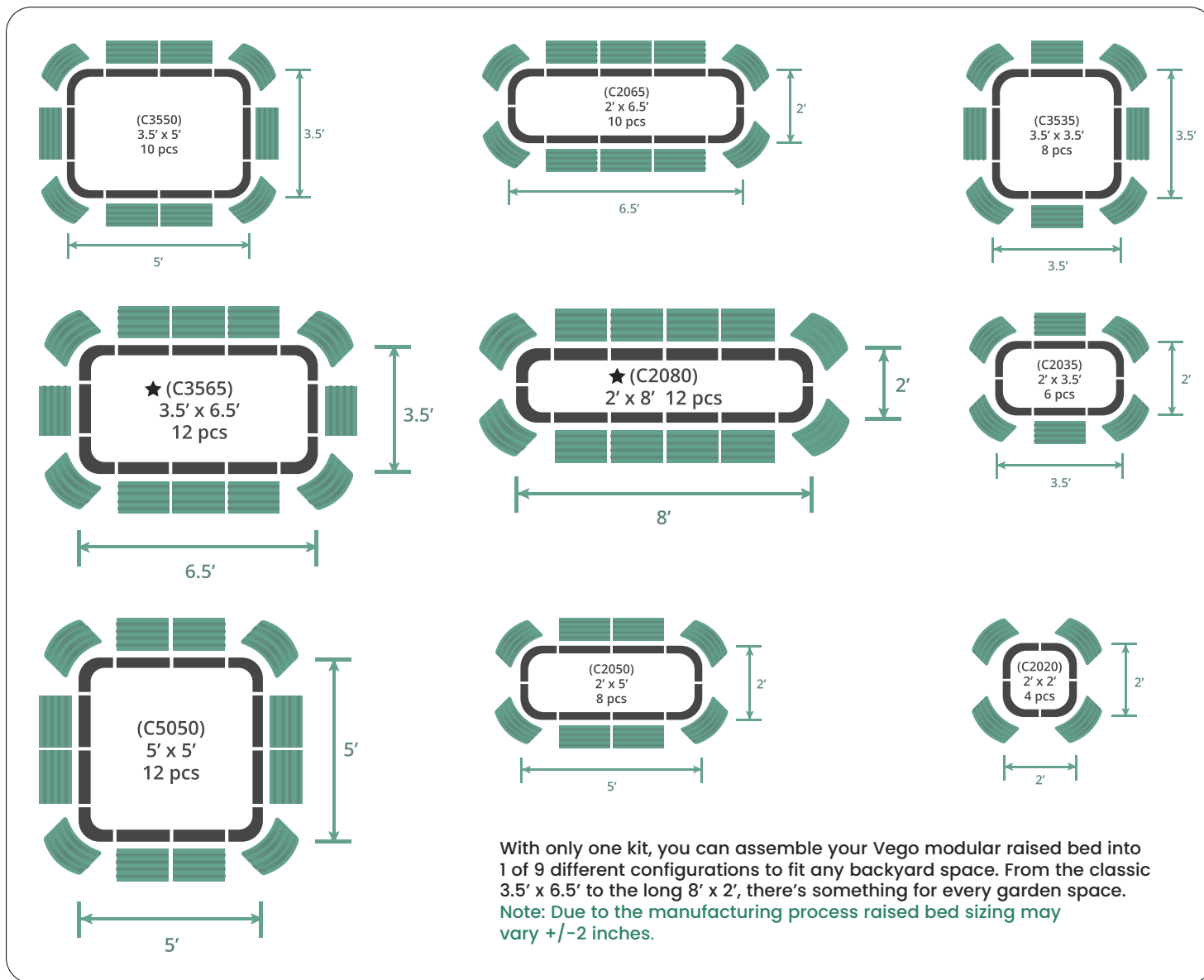

Dimensions

Configurations	Length (ft)	Width (ft)	Height (in)	Cubic Feet	Cubic Yards
★ C3565	3.5	6.5	11	21.0	0.8
★ C2080	2.0	8.0	11	14.6	0.5
C5050	5.0	5.0	11	23.0	0.9
C3550	5.0	3.5	11	16.0	0.6
C2065	2.0	6.5	11	12.0	0.4
C3535	3.5	3.5	11	11.2	0.4
C2050	2.0	5.0	11	9.0	0.3
C2035	3.5	2.0	11	6.4	0.2
C2020	2.0	2.0	11	3.7	0.1



11 Inch Tall 9 In 1 Modular Metal Raised Bed

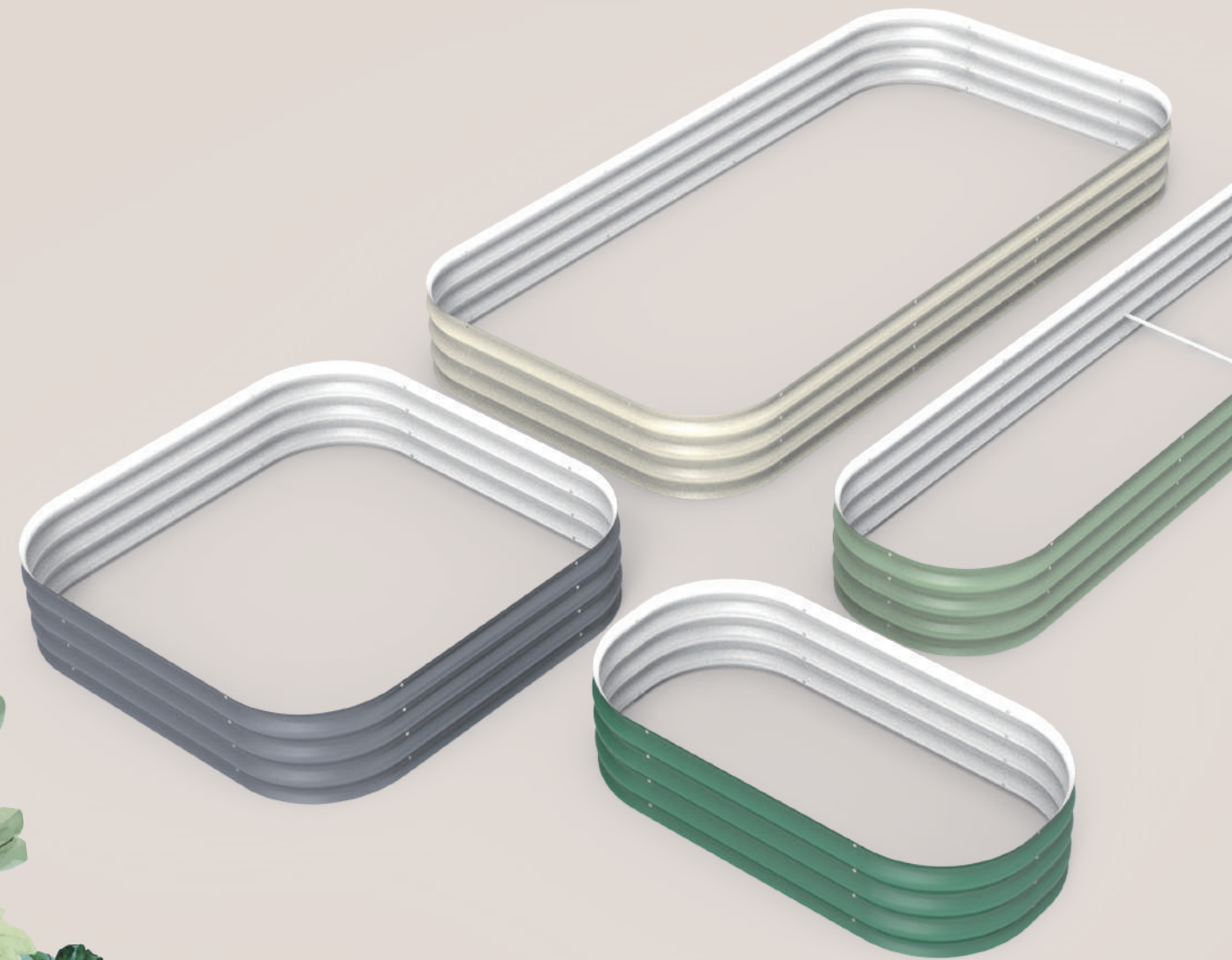

CAUTION: Please be aware the metal panels may have sharp edges that could cause injury. The use of protective equipment such as gloves and closed toe shoes is recommended.







CHOKING HAZARD: Small parts. Keep product away from children.

Contact Us
 +1 (866) 597-1888
 Houston, TX 77032

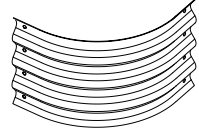
hello@vegogarden.com
 vego_garden

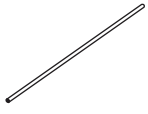
www.vegogarden.com
 Vego Garden - Raised Beds

Parts List

 SC10 x 4 Corner Panel	 SS15 x 8 Side Panel	 SE x 1 Safety Edging	 BR20 x 1 Bracing Rod
 B1 x 48 Bolt M6	 FN x 24 Standard Flange Nut	 FCN x 24 Flange Cap Nut	 LW x 1 L Wrench

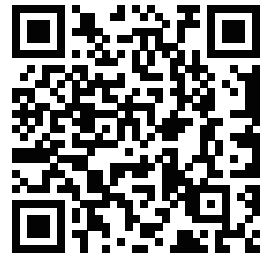

More assembly videos!



More add ons!

5 Step 5

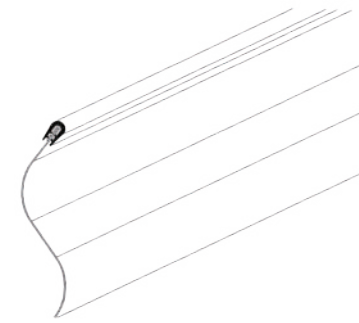

Push the safety edging along the top rolled steel edge, and cut the extra length off.

6 Step 6

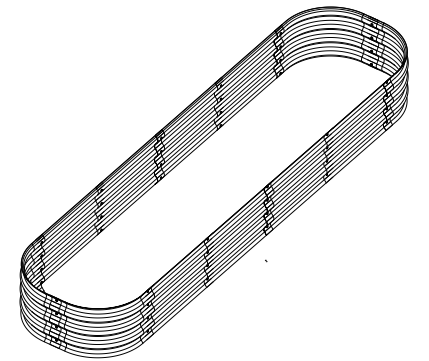

Congratulations on completing assembly! We are sure there are more configurations that you can build with your great imagination!

Assembly Guide www.vegogarden.com/assembly

1 Step 1

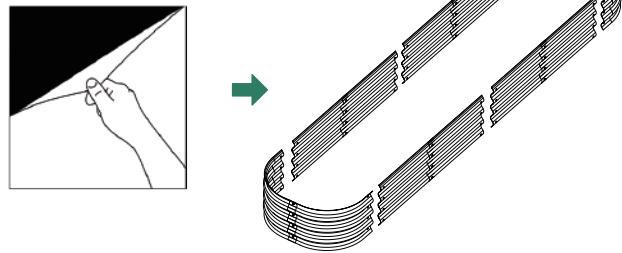

Remove the protective film from all panels, and lay panels on a flat surface according to the configuration you choose.

2 Step 2

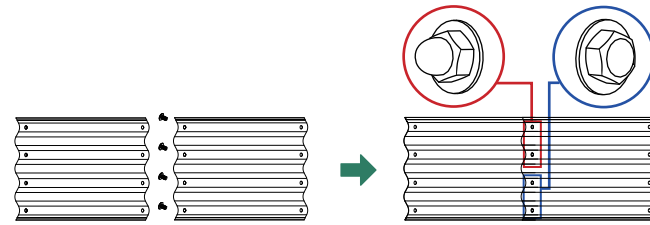

Cap nuts are used for the top two rows, standard nuts are used for the lower two rows. Assemble all straight panels. First, attach all bolts and nuts loosely, then tighten using the wrench or with a screwdriver and cordless drill.

3 Step 3

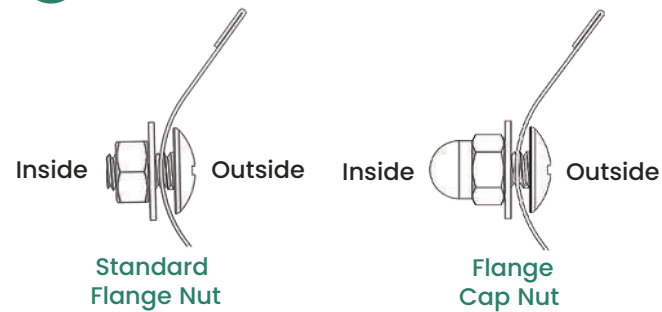

Make sure to tighten each nut and bolt to support the raised garden bed.

4 Step 4

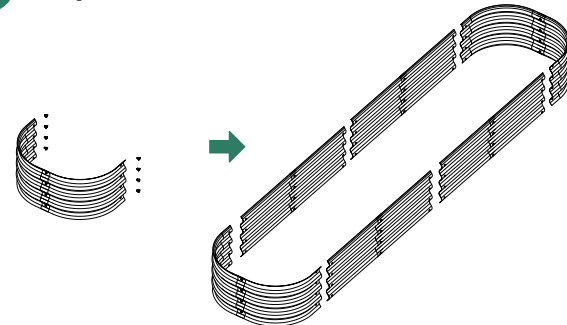

After straight panels are assembled, attach corner panels to straight panels using the same method. Make sure corner panels are attached outside of the straight panels.

1 Step 1

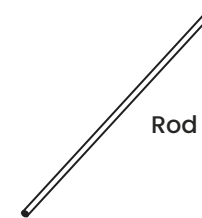

Vego Garden bracing rods are used to reinforce the strength of long raised beds. For the 11 inch 9 in 1, only the 2ft wide configurations need a rod.

2 Step 2

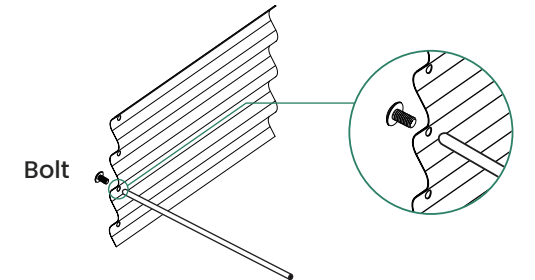

Install the bracing rod between two parallel bolt holes. Attach bolt, panel, washer & rod loosely, making sure that the rod is connected in the **third** bolt hole from the top. Then tighten it up with the screwdriver for reinforcement of raised bed.

3 Step 3

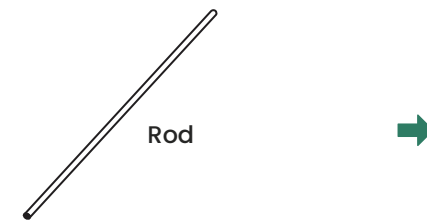

Install one rod in the center seam of your configuration, or as close to the center as possible.