

Zehnder ComfoAir Q 350

Wall or floor mounted mechanical supply and extract ventilation with heat recovery (MVHR) with humidity sensor

Product data sheet

always the best climate



ComfoAir Q 350

The Zehnder ComfoAir Q, with state of the art design and intelligent technology, regardless of whether you are working on a new build or an old building, with Zehnder comfortable ventilation you have an innovative, tried and tested complete system. It contains features such as its automatic modulating true summer by-pass, world class heat recovery efficiency and integrated humidity sensor to provide a comfortable, healthy and energy-efficient indoor climate.



Example controls - sold separately



ComfoControl RFZ



ComfoSense C67



ComfoSwitch C67



ComfoControl App

Key Benefits

- World class 96% efficiency.
- 100% full and filtered modulating summer bypass.
- First unit to be recognised by the PHI for its "cold recovery" efficiency
- Left or right hand configuration through software alone, no mechanical alteration required.
- Commissioning wizard for a quick and simple set-up process.
- Flow control to maintain commissioned flow rates.
- Adaptive comfort technology.
- Automatic passive temperature boost in summer.
- Humidity boost continuously monitors the humidity level within the home and looks for a man-made spike before boosting the unit, irrespective of distance or dilution.
- Tool free filter access.
- ISO ePM1 >65% (F7) filter option.
- App for installer and end user option.
- Wireless commissioning option.
- Remote access option.
- KNX compatibility option.
- 0-10V input option.
- Internal pre-heater option.
- Post heater control option.
- Enthalpy cube option.
- Passive House certified.

Article Numbers

Description	Product Code
Unit	
Zehnder ComfoAir Q350	471 502 015
Zehnder ComfoAir Q350 with pre-heater, right handed	471 502 016
Zehnder ComfoAir Q350 with pre-heater, left handed	471 502 017
Zehnder ComfoAir Q350 with enthalpy exchanger	471 502 018
Controls	
Controls, Zehnder ComfoSense C 67 remote display for Zehnder ComfoAir Q350/450/600, incl. mounting box	655 010 235
Controls, Zehnder ComfoSwitch C 67 speed controller for Zehnder ComfoAir Q350/450/600, incl. mounting Box	655 010 255
Controls, ComfoControl RFZ wireless controller for use with ComfoSense 67/C67 (CCRFZ)	655 000 755
Controls, ComfoControl RFZ Timer wireless controller for use with ComfoSense 67/C67	655 000 780
Controls, Zehnder ComfoConnect KNX C for ComfoAir Q350/450/600	655 011 120
Controls, Zehnder ComfoConnect LAN C for ComfoAir Q350/450/600	655 011 100
Controls, Zehnder Option Box with additional connectivity for Zehnder ComfoAir Q350/450/600	471 502 105
Controls, Zehnder ComfoSplitter for ComfoAir Q350/450/600	655 010 275
Controls, Zehnder RF-PCB to offer wireless connectivity to the CCRFZ without the use of a ComfoSense C67	400 502 016
Controls, 12V 0-10V CO2 sensor and combined three position switch	655 000 855

Article Numbers

Description	Product Code
Support Frame	
Support frame for Zehnder ComfoAir Q350/450/600, height 252 mm	471 502 008
Filters	
Filter for Zehnder ComfoAir Q350/450/600, ISO Coarse >65% (G4), 2 Pieces	400 502 012
Filter for Zehnder ComfoAir Q350/450/600, ISO Coarse >65% (G4), 10 Pieces	400 502 014
Filter for Zehnder ComfoAir Q350/450/600, ISO Coarse >65% (G4), 50 Pieces	400 502 021
Filter for Zehnder ComfoAir Q350/450, ISO Coarse >65% / ISO ePM1 >65% (G4 / F7), 2 Pieces	400 502 013
Filter for Zehnder ComfoAir Q350/450, ISO ePM1 >65% (F7), 10 Pieces	400 502 015
Filter for Zehnder ComfoAir Q350/450, ISO ePM1 >65% (F7), 50 Pieces	400 502 022
Accessories	
Heat exchanger for Zehnder ComfoAir Q350/450/600	400 502 008
Enthalpy exchanger for Zehnder ComfoAir Q350/450/600	400 502 010

SAP PCDB

	SFP (W/l/s)		Efficiency (%)	
	2009	2012	2009	2012
K+1	-	0.60	-	96%
K+2	0.60	0.53	96%	95%
K+3	0.51	0.57	95%	94%
K+4	0.50	0.64	95%	94%
K+5	0.54	0.72	94%	93%
K+6	0.60	0.89	94%	93%
K+7	0.68	1.03	94%	93%



Based on average climate with local demand control

Passive House Certification

	Standard heat exchanger	Enthalpy heat exchanger
Air flow range	70-270 m ³ /hr	70-270 m ³ /hr
Heat recovery rate	HR = 91%	HR = 86%
Specific electric power	Pel,spec = 0.24 Wh/m ³	Pel,spec = 0.22 Wh/m ³
Humidity recovery		x = 73%
Air flow range	71-270 m ³ /hr	71-262 m ³ /hr
Cold recovery rate	HR = 87%	HR = 81%
Specific electric power	Pel,spec = 0.22 Wh/m ³	Pel,spec = 0.21 Wh/m ³
Humidity recovery		x = 75%



Pressure Curve

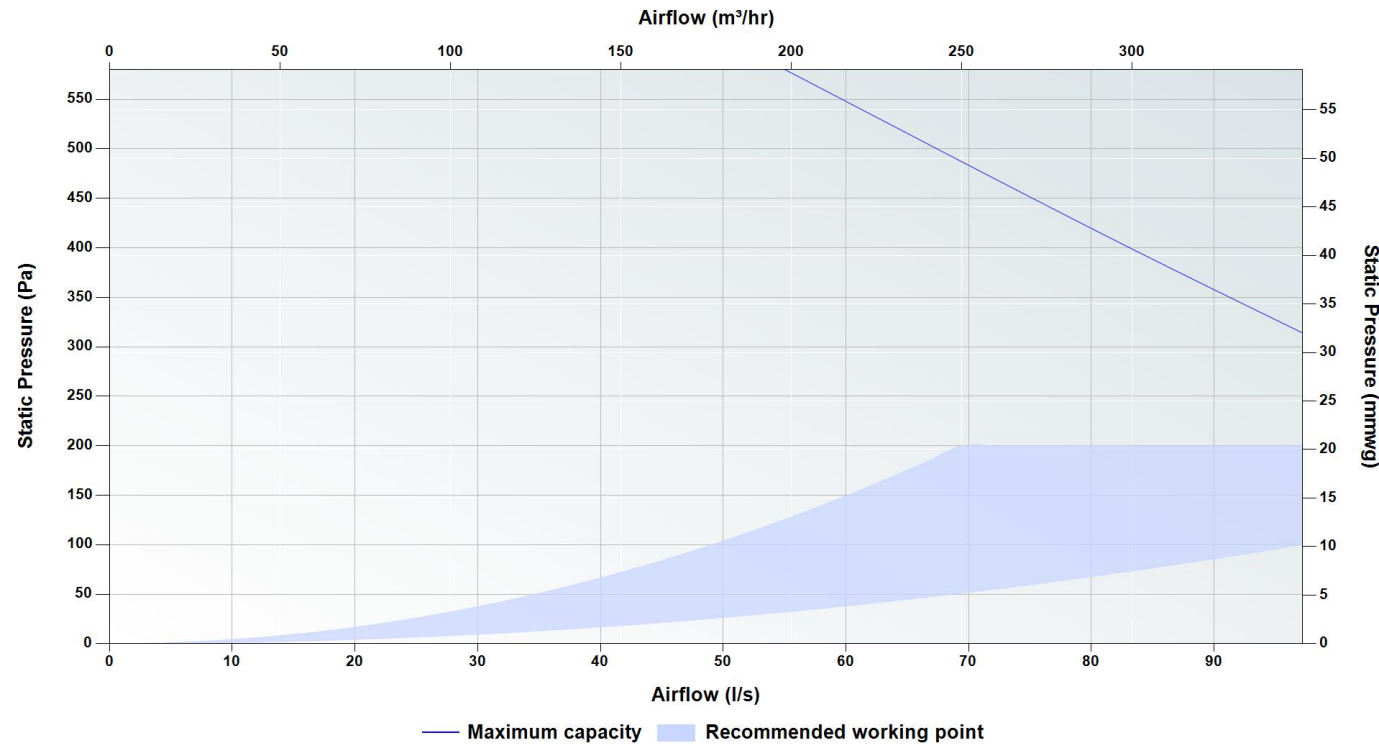

Sound Data

Speed	Test area	Octave Band (Hz) Sound Power Level, dB								dB(A) @ 3 m
		63	125	250	500	1000	2000	4000	8000	
20%	Casing	40.2	35.2	31.2	25.5	19.6	14.8	10.6	16.7	10.4
	Supply/Exhaust	55.7	50.7	43.8	39.4	31.9	24.7	13.8	12.3	
	Extract/Intake	46.3	41.3	33.5	24.1	18.6	16.3	11.8	18.5	
40%	Casing	47.5	42.5	40.8	35.0	28.9	26.1	20.6	19.0	19.6
	Supply/Exhaust	62.1	57.1	54.8	49.4	42.7	38.3	29.4	22.9	
	Extract/Intake	52.5	47.5	43.5	33.2	26.1	22.6	17.1	18.7	
60%	Casing	53.3	48.3	48.4	42.5	36.3	35.1	28.6	20.8	27.1
	Supply/Exhaust	67.2	62.2	63.6	57.4	51.2	49.1	41.8	31.3	
	Extract/Intake	57.4	52.4	51.3	40.3	32.1	27.6	21.3	18.9	
80%	Casing	59.1	54.1	56.1	50.2	43.8	44.1	36.6	22.7	34.9
	Supply/Exhaust	72.4	67.4	72.4	65.5	59.8	60.0	54.3	39.8	
	Extract/Intake	62.4	57.4	59.3	47.5	38.2	32.7	25.6	19.1	
100%	Casing	60.0	55.0	57.2	51.3	44.9	45.5	37.8	22.9	36.1
	Supply/Exhaust	73.1	68.1	73.7	66.7	61.1	61.6	56.2	41.1	
	Extract/Intake	63.2	58.2	60.5	48.6	39.1	33.4	26.2	19.1	

Casing tested according to ISO 3741:2010. Supply and Extract tested according to ISO 5135:1997 showing induct sound power level corrected for end duct reflection according to EN 13053:2019. Casing dB(A) @ 3 m given as hemispherical.

Air Direction/Connection

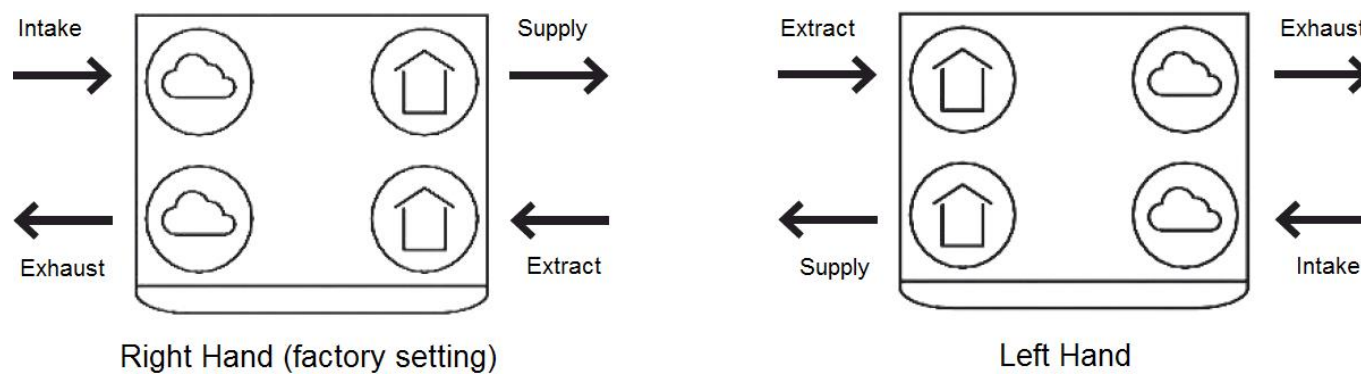

Technical Specification

Weight	50 Kg
Ducting ø	Internal - 160 mm External - 190 mm
Condensate connection ø	32 mm
Filter grade	Standard - ISO Coarse >65% / ISO Coarse >65% (G4 / G4) Optional - ISO Coarse >65% / ISO ePM1 >65% (G4 / F7)
Materials	Internal EPP / ABS External coated sheet steel
Supply voltage	230 V / single-phase / 50Hz
Maximum power consumption including / excluding pre-heater	1850 W / 180 W
Current draw including / excluding pre-heater	10.0 A / 1.42 A
Fuse rating including / excluding pre-heater	10 / 3 amp
Specific Fan Power	0.5 W/l/s
Heat Recovery Efficiency	0.96
Preheater power	1.7 kW

Dimensions

Height	850 mm
Width	725 mm
Depth	570 mm

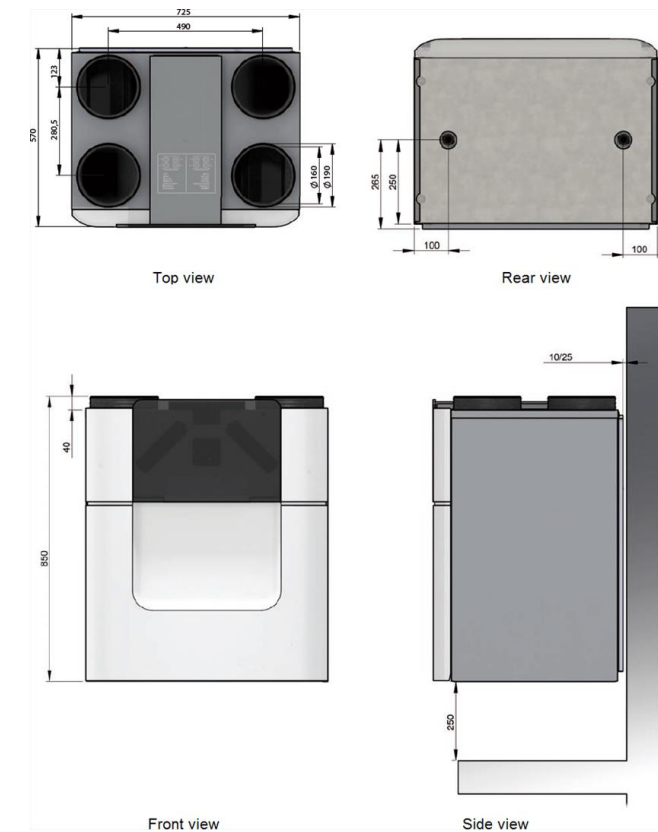

Wiring

Electrical connections should be carried out in accordance to IEE regulations by a qualified electrician. The unit is supplied with a flying lead for connection to the mains supply.

CAQ ancillary wiring

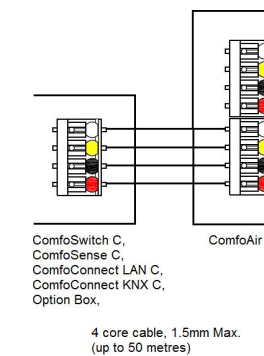

Controls

ComfoSense C67

Product code: 655 010 235



The Zehnder ComfoSense C67 is a four position switch designed to enable the user to manually select the desired ventilation systems flow rate and provide system notifications

Key Benefits

- 4 separate ventilation flow rate options to select in 1 controller
- 7 day flow rate programmer
- Summer bypass indicator
- Frost protection indicator
- Service and Maintenance alert
- Clock function
- User menu access
- RF bridge to enable use of the CCRFZ (655 000 755) controller

Technical Specification

Mounting options	Recessed / Surface
Supply voltage	Low voltage direct from the MVHR units ComfoNET connector
IP rating	IP44
Recommended cable	4 core cable, 1 mm Max. (up to 50 metres)
RAL colour	9016
Maximum number per unit	2 (3/6 if using ComfoSplitter unpowered/powered)
Supplied mounting box	655 010 270

Dimensions (recessed)

Height	80 mm
Width	80 mm
Depth	12 mm

Dimensions (surface mounted)

Height	80 mm
Width	80 mm
Depth	48.5 mm

ComfoSwitch C67

Product code: 655 010 255



The Zehnder ComfoSwitch C67 is a four position switch designed to enable the user to manually select the desired ventilation systems flow rate and provide system notifications

Key Benefits

- 4 separate ventilation flow rate options to select in 1 controller
- Temporary high speed activation setting
- Service and Maintenance alert

Technical Specification

Mounting options	Recessed / Surface
Supply voltage	Low voltage direct from the MVHR units ComfoNET connector
IP rating	IP44
Recommended cable	4 core cable, 1 mm Max. (up to 50 metres)
RAL colour	9016
Maximum number per unit	2 (3/6 if using ComfoSplitter unpowered/powered)
Supplied mounting box	655 010 270

Dimensions (recessed)

Height	80 mm
Width	80 mm
Depth	12 mm

Dimensions (surface mounted)

Height	80 mm
Width	80 mm
Depth	48.5 mm

ComfoControl RFZ

Product code: 655 000 755



The Zehnder CCRFZ is a three position switch designed to enable the user to manually select the desired ventilation systems flow rate and provide system notifications. This controller can only be used in conjunction with the ComfoSense or ComfoSense C.

Key Benefits

- Wireless controller
- 3 separate ventilation flow rate options to select in 1 controller
- 2 temporary high speed activation settings
- Service and Maintenance alert

Technical Specification

Mounting options	Surface
Supply voltage	Powered by a coin cell lithium battery (type: CR 2032)
IP rating	IP40
RAL colour	9010
Maximum number per unit	40

Dimensions (surface mounted)

Height	80 mm
Width	80 mm
Depth	14 mm

ComfoControl RFZT

Product code: 655 000 780



The Zehnder CCRFZT is a multi position switch designed to enable the user to manually select the desired overrun timer duration.

This controller can only be used in conjunction with the ComfoSense or ComfoSense C.

Key Benefits

- Wireless controller
- 3 separate ventilation overrun timer options to select in 1 controller
- Manual override to prematurely turn off the overrun timer
- Controller service and connection alert

Technical Specification

Mounting options	Surface
Supply voltage	Powered by a coin cell lithium battery (type: CR 2032)
IP rating	IP40
RAL colour	9010
Maximum number per unit	40

Dimensions (surface mounted)

Height	80 mm
Width	80 mm
Depth	14 mm

ComfoConnect KNX C

Product code: 655 011 120



The Zehnder ComfoConnect KNX C enables the connection between the ventilation system and the KNX building management system.

Key Benefits

- Control and monitor the ventilation system via the KNX building management system
- Control ventilation flow rate, temperature profile, temporary high speed setting and external sensor set points
- Monitor ventilation flow rates, temperatures and external sensors
- 7 day flow rate programmer
- Service and Maintenance alert
- ETS5 compatible

Technical Specification

Supply voltage	Low voltage direct from the MVHR units ComfoNET connector
IP rating	IP30
Recommended cable	4 core cable, 1 mm Max. (up to 50 metres)
RAL colour	Front: 9003 Back: 7024
Device model	System B
Supported configuration mode	S-Mode
Supported ETS version	5
Zehnder KNX library available at	https://www.zehnder.co.uk
Maximum number per unit	1

Dimensions (surface mounted)

Height	120 mm
Width	76 mm
Depth	25 mm

ComfoConnect LAN C

Product code: 655 011 100



The Zehnder ComfoConnect LAN C enables the connection between the ventilation system and the ComfoControl app for iPhone and android devices.

Key Benefits

- Control and monitor the ventilation system via the ComfoControl app
- Control ventilation flow rate, temperature profile, temporary high speed setting and external sensor set points
- Monitor ventilation flow rates, temperatures and external sensors
- 7 day flow rate programmer
- Access the ventilation system remotely from anywhere in the world
- Service and Maintenance alert direct to your phone
- User menu access
- Installer menu access



Zehnder ComfoControl App

Technical Specification

Supply voltage	Low voltage direct from the MVHR units ComfoNET connector
IP rating	IP30
Recommended cable	4 core cable, 1 mm Max. (up to 50 metres)
RAL colour	Front: 9003 Back: 7024
Maximum number per unit	1

Dimensions (surface mounted)

Height	120 mm
Width	76 mm
Depth	25 mm

Option Box

Product code: 471 502 105



The Zehnder Option Box enables the connection between the ventilation system and various other external components.

Key Benefits

- 4 x 0-10V inputs for use with the 12V 0-10V RH sensor or 12V 0-10V CO2 sensor
- Volt free contact input
- Post heater integration
- ComfoFond-L Q or sub-soil heat exchanger valve integration
- External filter alert integration
- Service mode activation input to disable fans e.g. when fire alarm activated

Technical Specification

Supply voltage	Low voltage direct from the MVHR units ComfoNET connector Mains power - 230 V / single-phase / 50Hz
IP rating	IP40
Recommended cable	4 core cable, 1 mm Max. (up to 50 metres)
RAL colour	9018
Maximum number per unit	1

Dimensions (surface mounted)

Height	253 mm
Width	178 mm
Depth	60 mm

Wiring

The Bathroom Switch connection option - II

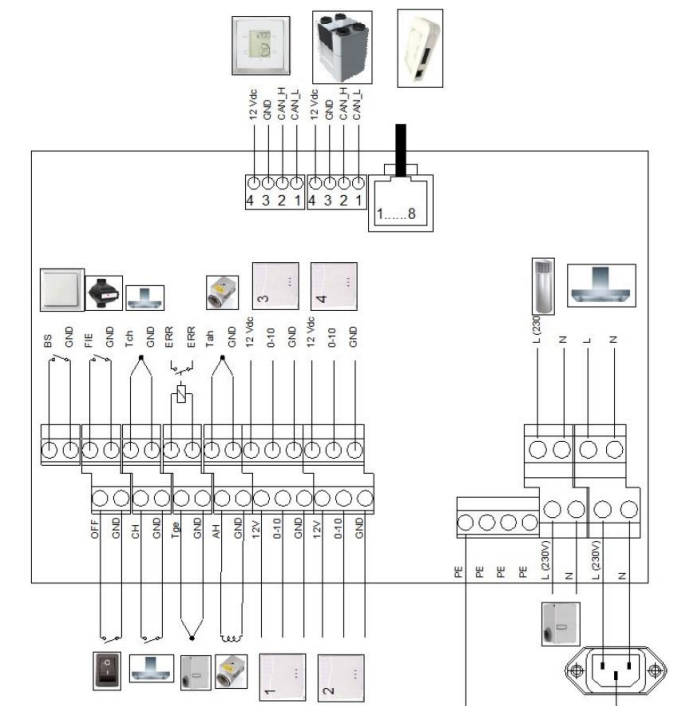
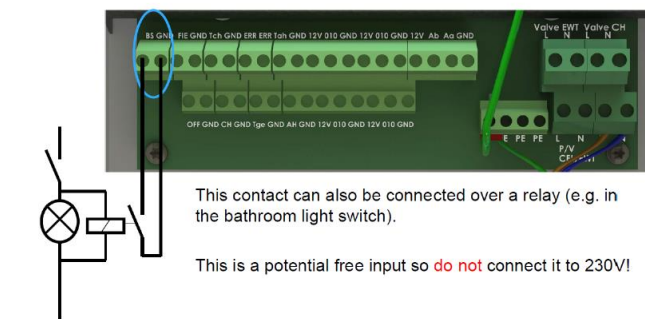

ComfoSplitter

Product code: 655 010 275



The Zehnder ComfoSplitter enables 5 additional ComfoNet connectivity options to the ventilation system.

Key Benefits

- 2 additional ComfoNet connectivity options when unpowered
- 5 additional ComfoNet connectivity options when powered

Technical Specification

Mounting options	Surface
Supply voltage	Low voltage direct from the MVHR units ComfoNET connector Mains power - 230 V / single-phase / 50Hz
IP rating	IP22
Recommended cable	4 core cable, 1 mm Max. (up to 50 metres)
RAL colour	9018
Maximum number per unit	1

Dimensions (surface mounted)

Height	108 mm
Width	53 mm
Depth	23 mm

12V 0-10V CO2 sensor

Product code: 655 000 855



The Zehnder 12V 0-10V remote CO2 sensor and combined three position switch is designed to enable the user to manually select the desired ventilation systems flow rate based on the visual air quality indicator, or automatically adjust the unit relevant to the CO2 level.

Key Benefits

- Green, orange and red visual air quality indication light
- 3 separate ventilation flow rate options to temporarily select in 1 controller for manual 12hr override
- CO2 measuring range 0-2000 ppm
- 0-10V output corresponding to measured CO2
- Discreet design

Technical Specification

Mounting options	Surface / Recessed
Supply voltage	12 V DC voltage direct from the MVHR units PCB connector
IP rating	IP30
Recommended cable	4 core cable, 1 mm Max. (up to 50 metres)
RAL colour	9016
Supplied mounting box	400 300 291

Dimensions (recessed)

Height	80 mm
Width	80 mm
Depth	12 mm

Dimensions (surface mounted)

Height	80 mm
Width	80 mm
Depth	43.5 mm

RF-PCB - ComfoAir Q

Product code: 400 502 016

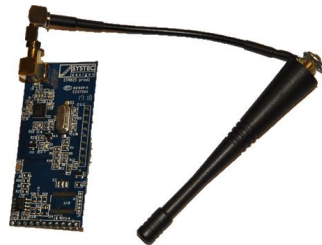

The Zehnder RF-PCB enables the CCRFZ (655 000 755) controller to be used with the ventilation system without the need for the ComfoSense C67.

Key Benefits

- Acts as a wireless receiver to the CCRFZ (655 000 755) controller without the need for the ComfoSense C67
- Built into the unit and not visible from the outside

Technical Specification

Mounting options	Inside the unit direct to the PCB
------------------	-----------------------------------

For use with

Our range of ComfoAir MVHR units can be used in conjunction with ComfoWell. The modular ComfoWell manifold can be combined with multiple circular connections for rigid round or semi-rigid connections. Along with filter boxes and attenuated manifold options, the ComfoWell is the perfect bespoke air distribution system for our ComfoAir MVHR units.

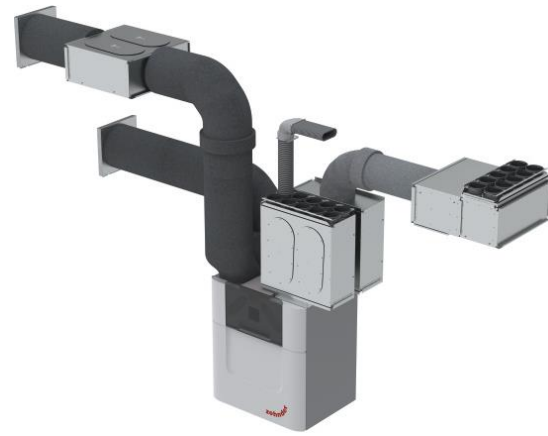

TO VIEW OUR COMFOWELL INFORMATION

[CLICK HERE](#)

BIM/CAD Components

If you would like to download the BIM / CAD files for this or any other of our products then please visit our BIM library.

TO VISIT OUR BIM/CAD LIBRARY

[CLICK HERE](#)

Installation Instructions

If you would like to download the installation files for this or any other of our products then please visit our download page by clicking the link below.

TO VISIT OUR DOWNLOAD PAGE

[CLICK HERE](#)

Our Informational Videos



Watch our video on how to install the Zehnder ComfoAir Q.

TO WATCH OUR VIDEO

[CLICK HERE](#)



Watch our video on how to clean the install ComfoTube Flat 51 ductwork.

TO WATCH OUR VIDEO

[CLICK HERE](#)

Consultant Specification

Specification

The unit shall consist of a body manufactured in powder coated sheet steel. The unit shall be fully insulated using high quality EPP to maintain excellent thermal characteristics and prevent shrinkage over time. It shall have EC motors with sealed for life bearings. The fans impellers should be low pressure centrifugal type with backward curved blades within ABS scroll housing and flow ring to provide accurate pressure measurement and incorporate a flow grid to optimise the airflow into the fan. The heat exchanger shall be a diamond shaped multi-plate, counter flow design constructed from Polystyrene with laser welded joints and shall retain up to 96% of the temperature differential of outgoing air with the option to upgrade to an enthalpy heat exchanger for latent and sensible heat transfer plus moisture recovery negating the need for a condensate drain.

The unit shall contain filters manufactured from recyclable material which has been tested to a minimum of [ISO Coarse >65% \(G4\)](#) standard with the option to upgrade to [ISO ePM1 >65% \(F7\)](#). The filters shall be pleated to reduce the pressure drop and required cleaning time. The unit shall have 160 mm duct connections, and be suitable for vertical wall mounting or floor stand with the ability to allow left or right hand configuration through the unit's software alone – no mechanical reconfiguration shall be required. Integrated modulating preheater options shall be available to regulate its output to enable balanced ventilation with external air temperatures -10°C.

The unit shall have a 100% full summer bypass using an in-line modulating mechanism to provide filtered supply air 365 days of the year, even under bypass conditions. It shall provide fresh filtered air to aid night time cooling and prevent condensation within the supply pipework, regardless of the external air temperature. The unit shall contain a temperature sensor for each air stream to ensure correct and logical operation of the bypass damper by evaluating differential as well as absolute temperature to maximise the opportunity for free cooling. The unit shall be certified by the PHI for its "cold recovery" during summer months to compliment any active cooling within the property. The unit shall control air flow to react to prolonged, sustained increased pressure drops to best achieve the commissioned flow rate even when filter degradation occurs. Airflow should not react to short term 'wind gusts' to avoid nuisance running.

The unit shall be constructed to have a removable cover to allow full maintenance access. The removable cover shall enable access to the supply/extract fan, heat exchanger and access to electrical connections. The motors shall be suitable for removal without the requirement for the unit to be removed from situ and be available as spare parts for a minimum of 10 years even after ceasing manufacture of the unit.

The unit shall conform to LVD and EMC standards and be CE Marked in addition to having an EU compliant energy rating label (SEC) with a minimum grade of A. The unit shall conform to [UK Electrical Equipment \(Safety\) Regulations](#) and [Electromagnetic Compatibility Regulations](#) and be UKCA Marked. The unit shall be manufactured by Zehnder.

Operation

The supply and extract unit shall be a ComfoAir Q manufactured by Zehnder and shall be suitable to mount on a floor stand, wall or in a cupboard in accordance with the specification.

The fresh filtered air from outside shall be supplied to each of the habitable rooms and pre-heated by the warm extract air from the wet areas, such as kitchen or bathroom, via the plastic counter flow heat exchanger. The unit shall vary its speed of the EC motors automatically when it receives a signal from one of the inbuilt sensors or via external switches.

The unit shall have the ability to adjust and commission the supply and extract motors independently via the front mounted in-built LCD interface. The motors shall both automatically adjust independently to the system pressure to achieve the input flow rate.

Controls

All ComfoAir Q units shall contain the following functions within the unit pre-wired and factory fitted by the manufacturer:

- Dial-a-duty motor control
- 4 Variable speed flow rate set points
- Automatic filtered modulating summer bypass with timed manual override option
- Heat exchanger frost protection
- Commissioning wizard to enable commissioning of the unit
- Integral service, fault and operation indicators
- Control panel PIN protection
- Tool free filter access
- Humidity sensors to operate the unit in response to humidity spikes above natural background humidity levels as opposed to a single threshold humidity point to activate the high set point
- Automatic passive boost for night time cooling
- Variable overrun timer relative to high speed activation period

Consultant Specification

All ComfoAir Q units shall contain the following options when combined with relevant ancillaries:

- BMS compatibility via KNX protocol option (ComfoConnect KNX C)
- Wi-Fi connectivity option (ComfoConnect LAN C)
- RFZ wireless connectivity option (RF-PCB or ComfoSense C 67)
- Switched live input option (Option Box)
- Volt free contact option (Option Box)
- 0-10V input option (Option Box)
- Pre-heater frost protection option
- Post-heater control option (Option Box)
- Control input for single or multiple capacitive touch speed controllers with 7 day programmer capabilities (ComfoSense C 67)
- Control input for single or multiple 4 speed manual/auto controller with filter alert (ComfoSwitch C 67)