



Manual 5-step speed controller for three-phase fans

- Manual control
- Frost protection safety function
- Remote on/off
- Integrated motor protection
- Operation indicator lamp
- Control of additional external equipment

[Find more details in our online catalogue](#)

Technical parameters

Nominal data	
Voltage (nominal)	400 V
Frequency	50; 60 Hz
Phases	3~
Input current	4 A
Protection/Classification	
Enclosure class	IP21
Ambient and duct temperature	
Max. Power dissipation	75 W
Dimensions and weights	
Depth	173 mm
Height	323 mm
Width	270 mm
Weight	11.1 kg

Wiring

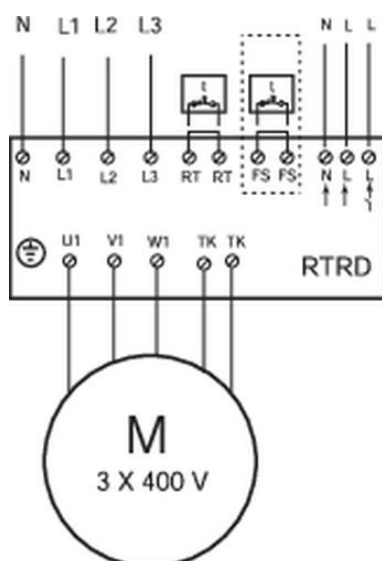

Documents

IMO RTRD, RTRDU_DE_GB_FR_SE.PDF
UKCA Declaration of Conformity_003