

RAW 630/710 Roof Cowl c/w BG

Item Number: 86531

The RAW horizontal discharge roof cowl is manufactured from UV stabilised glass reinforced polyester to ensure a rigid, lightweight, corrosion-free, weather resistant unit. Can be used purely as a terminal or combined with a ZSP or ZAP plate axial fan to create a powered extract/supply unit. Coloured to BS 00 A 05 goosewing grey as standard, but available in any BS or RAL colour if required. All RAW cowls are supplied fitted with a birdguard.



Technical parameters

Dimensions and weights

Weight

27 kg

Dimension

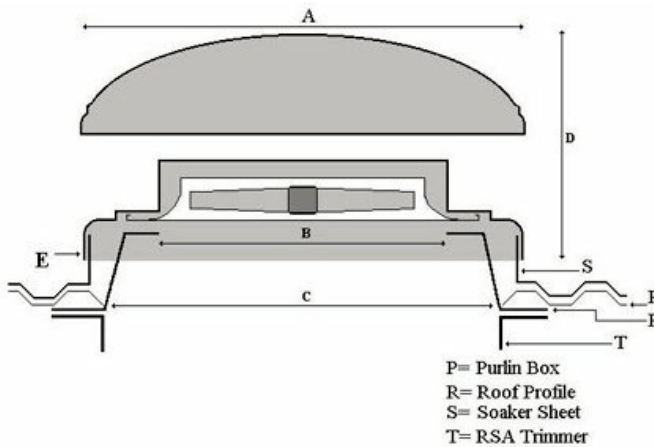

Unit Ref	A Weather Cowl sq	B Purlin box Aperture	C Purlin box base/Roof Aperture	D Unit Height	E Weatherskirt Base sq	S Soaker Sheet Kerb sq	Weight Kg ^{**}
RAW 200/250	490	310	480	270	460/490	440	4.25
RAW 300/315	555	350	515	340	520/555	510	6.5
RAW 350	675	400	680	380	660/695	640	8.5
RAW 400/450	765	510	780	460	755/795	750	12
RAW 500/560	995	620	910	550	920/960	890	21
RAW 630/710	1115	780	950	650	1010/1055	1000	27
RAW 800	1410	910	1150	750	1125/1170	1130	34
RAW 1000	1630	1140	1390	900	1370/1405	1370	45

*All dimensions indicated are nominal and subject to design change. The right to alter specification is reserved.

** Owing to the hand lay process, all weights are indicative and subject to variation.

Accessories

- BDS 630/710 RA b/d shutter (8676)
- SKR 630/710 RA soaker sheet (8463)
- PB 630/710 Purlin Box (8697)

Documents

- RAW_RAV O&M.pdf