

Lo-Carbon Heat Save dMVHR FAN

Installation and Wiring Instructions

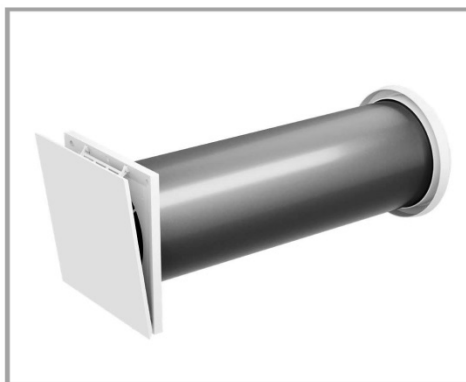

Stock Ref. N°
496036 - HeatSave

220-240V~50Hz

Vent-Axia®

IP20

PLEASE READ INSTRUCTIONS IN CONJUNCTION WITH THE
ILLUSTRATIONS. PLEASE SAVE THESE INSTRUCTIONS

CE
UK
CA

Contents

1	User and safety instructions	3
1.1	User information	3
1.2	Safety instructions	4
2	System overview & Installation Instructions	6
2.1	Construction	7
2.2	Function	8
2.3	Control elements	10
2.4	Assembly Instructions	11
3	Operation of the Heat Save ventilation unit	18
3.1	Opening/closing the inner cover	18
4	Operating the SENWZP Sentinel Kinetic Zone Controller	19
4.1	Design and features	19
4.2	Activating the controller	15
4.3	Setting mode	16
4.4	Set output	18
4.5	View hours run	19
5	Cleaning and maintenance	27
5.1	Cleaning/replacing dust filters	21
5.2	Removing the thermal accumulator insert	23
5.3	Cleaning and reassembling the thermal accumulator insert	24
6	Troubleshooting and disposal	27
7	Specifications	36
8	Accessories and spare parts	30
9	Guarantee and warranty	31
10	Service	31

1 User and safety instructions

Thank you for purchasing this high quality product from Vent-Axia!

Your Vent-Axia Heat Save product is an exclusive system for the ventilation of your living premises, which additionally contributes to improving energy efficiency via the principle of heat recovery. Our Vent-Axia Heat Save ventilation units are made to the highest quality standards using premium materials.

This section provides an overview of the basic safety precautions for safe and proper operation of your ventilation unit.

1.1 User information

Concept of safety instructions

The safety and warning instructions in these operating instructions have a uniform structure and are marked with a symbol on the left side of the instruction. A signal word in front of the text also indicates the hazard level. If several hazard levels exist, the highest level safety instruction is always used.

The safety and warning instructions contain the following information.



SIGNAL WORD: Type and origin of the hazard. Possible consequences of the hazard!
Measures to avoid the hazard.

A signal word indicates the severity of the potential hazard unless the preventative measures are taken.



WARNING indicates: Possible danger of serious injury or death.



CAUTION indicates: Imminent or possible risk of minor/significant injury.



NOTICE indicates: Imminent or possible damage to property due to an adverse event/state.

If you see this sign, ensure you observe the described measures to prevent possible hazards and/or damage.

Other symbols used in this documentation

In addition to the safety instructions, the following symbols are used:



A **TIP** symbol indicates practical and useful tips for handling your ventilation unit.



A tool symbol before an installation sequence lists any additional tools and materials required for the described task.



A **Red frame** surrounding a graphic indicates that the interior wall is shown.

► **Action required:** this requires you to perform a specific action.

⇒ **Check the results:** this requires you to check the results of the action you have performed.

1.2 Safety instructions

These Installation and operating instructions are part of the ventilation unit and must be permanently available. When handing the equipment/system to a third party, the instructions must be handed over also. Please read these instructions carefully before installing, operating or cleaning the system and observe all information provided in this section about installation, operating, cleaning and maintaining your system. Also note the safety instructions that precede the described handling instructions. Non-observance of safety warnings could result in injury and/or property damage.

Intended use

The ventilation unit is designed to ventilate dwellings and similar residential spaces. It is controlled via an SENWZP Sentinel Kinetic Zone Controller.

General instructions

- Use the equipment/system exclusively for the applications that are described in this documentation and only in conjunction with components that are recommended, authorised and described by Vent-Axia in this documentation. Changes or modifications to the equipment/system are not permitted.
- Your ventilation unit is exclusively designed for use in ambient temperatures between -20 and 50 °C.
- Proper operation and cleaning/maintenance are required for trouble-free and safe operation of the equipment/system.
- **WARNING:** Install a pressure monitor in rooms with open flues. In any case air exchange must be assured to be sufficient for the ventilation units as well as the fire place.
- Consult your chimney sweeper and/or building planner before installation!
- **NOTICE:** Do not place the unit near radiators, room thermostats or in the immediate vicinity/ above sensitive paintings or furniture.
- **NOTICE:** Maintain a minimum circumferential clearance of 250 mm to avoid the mixing of outdoor air and exhaust air.
- **NOTICE:** Observe the predetermined minimum distance of 300 mm in front of the ventilation unit to ensure access to the unit and its components. Remove/avoid obstacles that hinder access to, or removal of, the unit's components.



Assembly and installation

CAUTION: Installation of the system may only be performed by qualified personnel.

Before starting work, you should have a ventilation concept from which the number of ventilation units, their position, the ventilation principle (cross ventilation, individual room ventilation, extraction) and the relevant controllers can be determined. The exact positioning of the units and controllers must be determined on-site and, if necessary, adapted to the local conditions by the user/planner. Installation is recommended in a suitable position in the upper wall area for optimal operation.

WARNING: Install a pressure monitor in rooms with open flues. In any case air exchange must be assured to be sufficient for the ventilation units as well as the fireplace. Consult your chimney sweeper and/or building planner before installation!

NOTICE: The ventilation unit must not be used for drying out buildings. It must not be put into operation until after completion of the construction work. The ventilation unit must remain sealed against dust during the construction work (attached protective discs).

NOTICE: Do not place the unit near radiators, room thermostats or in the immediate vicinity/ above sensitive paintings or furniture.

NOTICE: Install the wall sleeve outside airtight and inside vapour tight into the air resistance layer. Material must be provided by the customer. After installing the wall sleeve replace the wall structure as far as the wall sleeve and observe the necessary barrier levels in order to avoid the interruption of the thermal insulation composite system. Consult your planner!



NOTICE: Install the wall sleeve with a slope of 1 – 2° to the exterior wall in order to ensure that occurring condensate may drain away.

NOTICE: The ventilation unit must not be installed in areas in which direct contact with water spray is possible.



NOTICE: In order to prevent algae accumulation and a discolouration of the façade around the exterior closure observe all installation advice (apply all sealing tapes!). In vulnerable areas, apply a biocidal/water repellent treatment to the plaster surface around the weather protection grille before installing. Consult your planner!

NOTICE: When installing components to (exterior) walls with insulation use insulation plugs to ensure safe fastening. These are not part of the scope of supply but are available as an option.

NOTICE: Exclusively use permanently elastic sealing compound for exterior/outdoor use to seal the joints between the façade and the weather protection grille.

NOTICE: Your ventilation unit has scratch-sensitive plastic surfaces. Do not touch the inner cover with oily and/or dirty hands. Avoid contact with sharp or pointed objects, e.g., rings.

Wiring/Electrical connection of the fan



CAUTION: Electrical connection of the system may only be performed by qualified personnel.

NOTICE: Your ventilation unit operates with a safety extra low voltage (SELV) and an operating voltage of 6 – 16 V DC. The ventilation unit must therefore not be connected directly to the 230 V mains but must always be connected via a controller.



NOTICE: We recommend using 3-core flexible cables (3x0.75) when wiring up.

NOTICE: Laying of cables without a plaster-resistant sheath underneath the plaster/concealed may result in short-circuit and cable fire. Exclusively lay cables without a plaster-resistant cable sheath inside an empty conduit.

NOTICE: Remove the cable sheath on the fan BUS up to the wall sleeve. This prevents malfunction of the ventilation unit due to cable breakage when the inner cover is inserted. The ventilation units must be synchronised when using multiple ventilation units controlled via multiple controllers (see installation and operating instructions for the controller). All of the controllers should be connected via a mains fuse in the building distributor.

If your equipment/system has a defect, contact your nearest distributor or our technical service. Any kind of use other than the intended use will exclude all liability claims.

Cleaning and maintenance



- **CAUTION:** Operation and/or maintenance of the ventilation unit and its controllers must not be carried out by children and/or persons who are not fully capable of doing so due to their physical, sensory or mental capabilities, inexperience or lack of knowledge. Young children should be supervised to ensure that they do not play with the device.
- **NOTICE:** Your ventilation unit and controller have scratch-sensitive plastic surfaces. Do not touch the inner cover with oily and/or dirty hands. Avoid contact with sharp or pointed objects, e.g. rings.
- **NOTICE:** Do not use strong cleaning agents or solvents. Use a soft, damp cloth to clean the plastic surfaces.
- **NOTICE:** Your Vent-Axia ventilation unit operates with a protective low voltage and an operating voltage of 6 – 16 V DC. The ventilation unit must not be connected directly to the 230 V power grid. It must always be connected via a SENWZP Sentinel Kinetic Zone Controller.
- Before performing cleaning or maintenance tasks, disconnect the controller's power supply and put on gloves.
- Never use the unit without the filters and inner cover



Use the SENWZP Sentinel Kinetic Zone Controller exclusively to control Vent-Axia Heat Save ventilation units with heat recovery.

If your ventilation unit has a defect, contact your nearest distributor or our technical service.

Any kind of use other than the intended use will exclude all liability claims.

Improper use

Any use that is not mentioned in the intended use section, is considered to be improper.

Do not install the equipment in areas which...

- Contain (or may contain) strong oils or lubricants.
- Contain (or may contain) flammable gases, liquids or vapours.
- Contain (or may contain) extreme dusts.
- Are exposed to ambient temperatures below -20 °C and above 50 °C.
- Contains obstacles that hinder access to, or removal of, the unit's components.
- it is used to dry up the structure.

Qualified personnel

The equipment/system may only be Installed, setup, operated and maintained in conjunction with this documentation and the documentation for the controllers.

Any necessary cleaning or maintenance tasks can be carried out by the user by following the instructions. Operation and/or maintenance of the ventilation unit and controller must not be carried out by children and/or persons who are not fully capable of doing so due to their physical, sensory or mental capabilities, inexperience or lack of knowledge.

Assembly and installation

Installation, electrical connection and set up of the equipment may only be performed by qualified personnel. Qualified personnel within the meaning of the safety notices in this documentation are persons who are authorised to install, put it into operation and identify equipment, systems and circuits in accordance with established safety procedures.

Conformity

The ventilation unit complies with the applicable technical safety requirements and standards for household and similar electrical appliances. They are conforming to the following European directives:

- 2014/30/EC: Electromagnetic compatibility directive
- 2009/125/EC: Energy related products directive
- 2014/35/EC: Low voltage directive
- 2011/65/EC: Restriction of certain Hazardous Substances (RoHS) directive

2 System overview

The Heat Save ventilation system is a decentralised system with a compact design. It ventilates living rooms and bedrooms in single- and multi-family houses, hotels and guest houses, rooms in public facilities and work rooms in office buildings. It is usually located in the exterior wall.

The construction of the Heat Save complies with the applicable European regulations.

The Heat Save ventilation unit comprises a wall sleeve into which a thermal accumulator insert is installed. An inner cover with quick lock and slim design conceals the ventilation unit visually discreet on the interior wall side. The integrated filter reduces pollen or dust entering the interior room from outside. On the exterior wall a weather protection grille covers the unit.

Into the wall sleeve the thermal accumulator, and fan assembly consisting of two airflow optimising guiding vanes and fully reversible fan. The guiding vanes on both sides of the fan ensures efficient capacity utilisation and even flow through the thermal accumulator.

It is controlled via the SENWZP Sentinel Kinetic Zone Controller.

Components (see fig.1 page 8)

- Inner cover incl. dust filter of class G4
- Thermal accumulator insert (thermal accumulator, fan assembly)
- Wall sleeve
- Exterior closure
- Sound and wind protection options available as accessory

Models

- Heat Save ventilation units with external grille and inner cover (both white)

¹⁾ The installation and operating instructions for the controller do not form part of this documentation and are supplied separately.

21 Construction

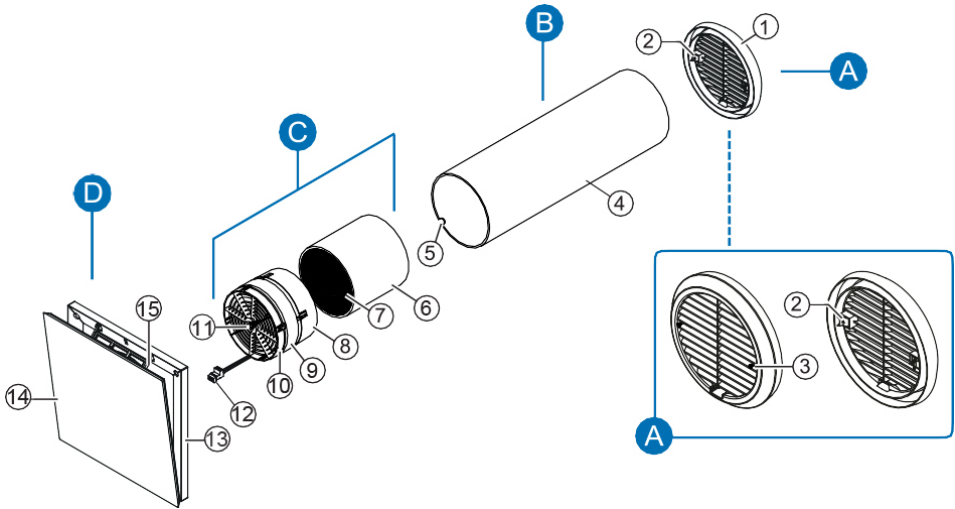

Figure 1: Overview of Heat Save ventilation unit

Components

A Exterior closure: Light protective grille

- 1 Protective grille
- 2 Fastening claws (2 x, pre-assembled)
- 3 Fastening screws (2 x, pre-assembled)

B Wall sleeve

- 4 Wall sleeve
- 5 Recess for fan BUS (interior wall side)

C Thermal accumulator insert

- 6 Thermal accumulator with insulation
- 7 Thermal accumulator handle
- 8 Standard guiding vane (broad)
- 9 Reversible fan
- 10 Slim guiding vane (narrow)
- 11 Guiding vane knob
- 12 Plug connection

D Inner cover 220mm x 220mm

- 13 Inner cover base plate (incl. dust filter G4)
- 14 Inner cover panel
- 15 Connecting element

2.2 Function

The Heat Save ventilation units are used to provide ventilation for living rooms and bedrooms. An integrated thermal accumulator in combination with the reversible fan and the guiding vanes ensures optimum heat recovery with maximum air flows in its class.



The ventilation unit operates on the principle of heat recovery by changing the direction of the fan. The integrated thermal accumulator charges itself with heat energy from the room's air as it flows to the exterior (extract air). After 70 seconds, each reversible fan changes direction. When the reversible fan changes direction, it releases the stored heat energy into the incoming outside air (supply air).

For this principle to work correctly and to ensure the room's pressure stability the incoming air and extract air volumes must match, i.e. two Heat Save ventilation units are required. These are operated in pairs in push-pull operation: One ventilation unit works in supply air mode while the other works in extract air mode at the same time.

The Vent-Axia Heat Save is not only characterised by a discreet and slim visual appearance. Due to the fan's sensor technology it also has a high pressure stability: high pressure build up and an active speed control (integrated wind stabiliser) keep the air flow within the system nearly constant (max. 30 % deviation). The reversible fan thus fulfils the S3 classification in accordance with EN 13141-8.

In order to ensure the full functioning of the ventilation system throughout the entire year, an additional, flexible temperature sensor is integrated into the reversible fan. At the reversal moment, this measures the temperature of the flow rate at the reversible fan. If the temperature falls below +5°C, the reversible fan is automatically switched to extract air mode for 4 cycles.

This allows the thermal accumulator to heat up again and prevents cooling of the interior due to cold drafts. During this phase, the mode that has been set on the controller is ineffective. Subsequently, the controller switches the ventilation unit back to the originally selected mode.

A multi-use dust filter of filter class PM10 ISO Coarse 60% (G4) is integrated discreet and ease of access into the inner cover. It partially filters dusts as well as allergenic particles (such as pollen) from the ambient air before it can enter living spaces. Dust filters are season independent.

A decentralised ventilation system is based on the free movement of air between individual pairs of ventilation units. Therefore, internal doors must not have air-tight seals.

Ensure adequate air transfer measures: An air gap of about 10 mm below the door, unscrew the hinges by 5 mm, use a ventilation grille or similar (cross ventilation).

2.3 Control elements

SENWZP Sentinel Kinetic Zone Controller



The SENWZP Sentinel Kinetic Zone Controller is an electronic control unit for controlling the Heat Save ventilation units.

They are characterised by their timeless and slim design, and a simple touch-based operating concept.

The controller is used to control up to eight Heat Save ventilation units.

The connected ventilation units can be controlled in the following modes:

- Heat recovery
- Continuous ventilation
- Pause function
- Off

2.4 Assembly and Installation



Additional required tools and materials

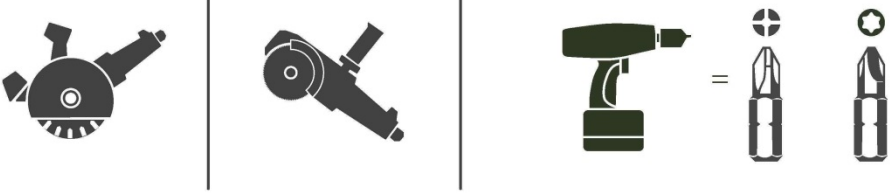
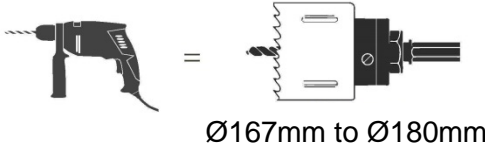

Cable (braided flex),
3 x 0.75 mm²



Wire ferrules with
collar



0.75 mm²

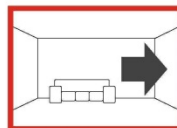

Interior wall

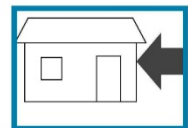

Exterior wall



Checking the scope of supply

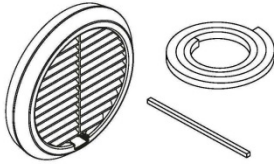

Item no. 1508-0110

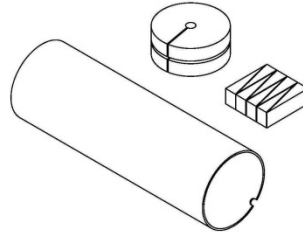

Item no. 1506-0068 / 1506-0069

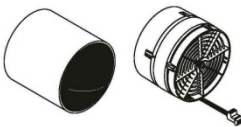

Item no. 1507-0021

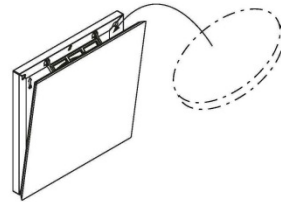

Item no. 1505-0039

Creating the wall opening

1

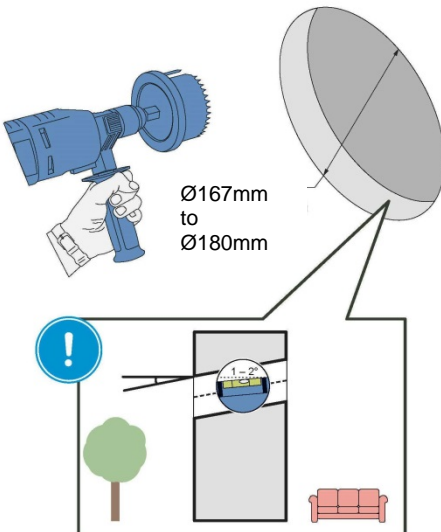

2

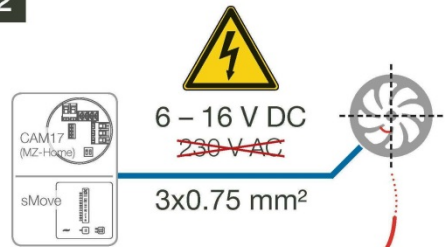

3

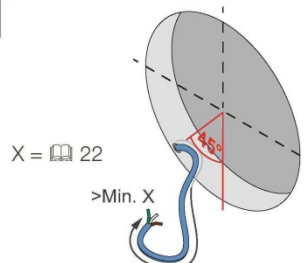

Installing the wall sleeve

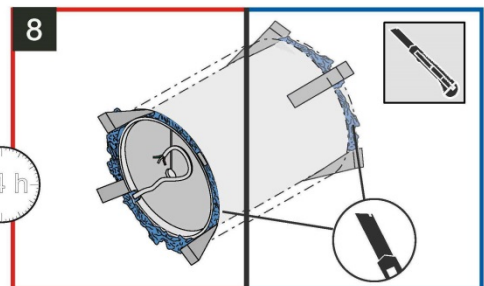
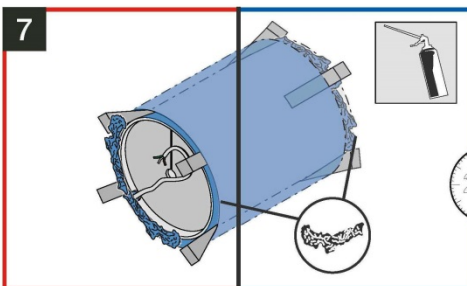
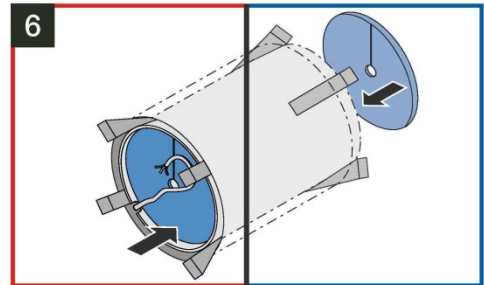
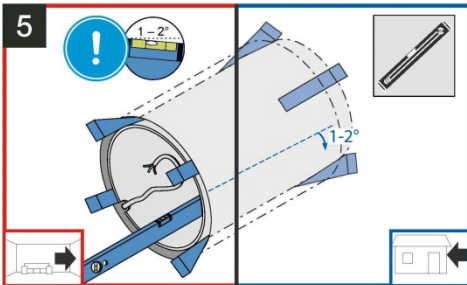
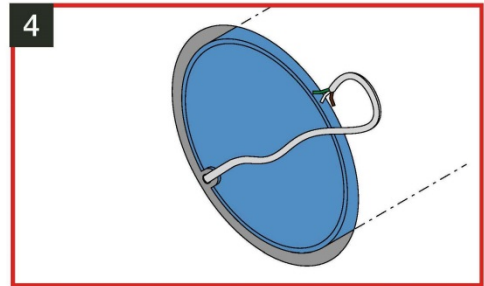
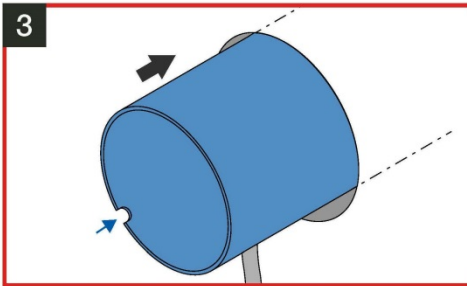
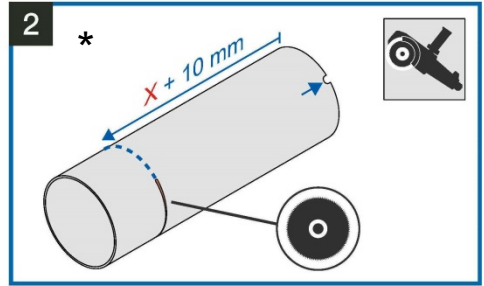
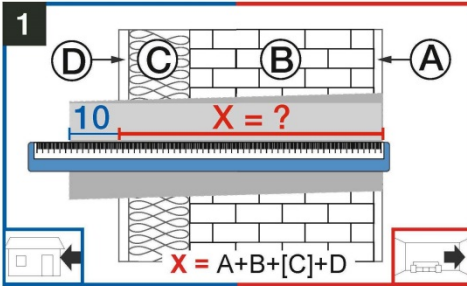

* Do not cut the wall sleeve any shorter than 300mm - this is the minimum length required to house the fan and the ceramic thermal accumulator as well as ensuring the internal and external grilles attach.

Installing the Exterior grille

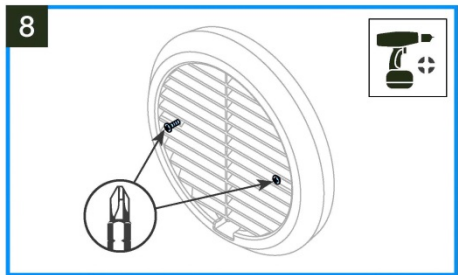
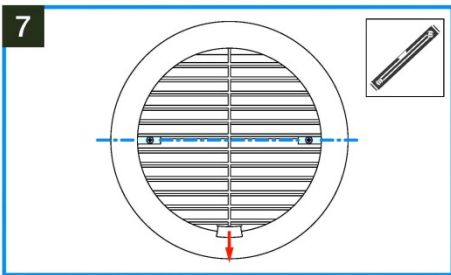
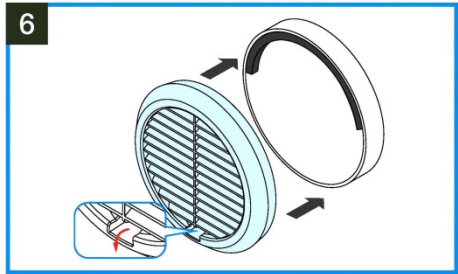
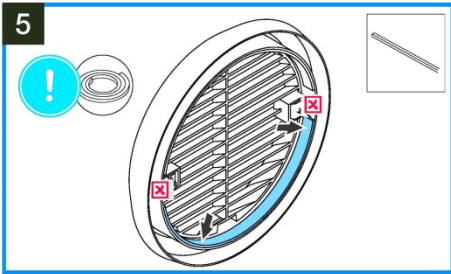
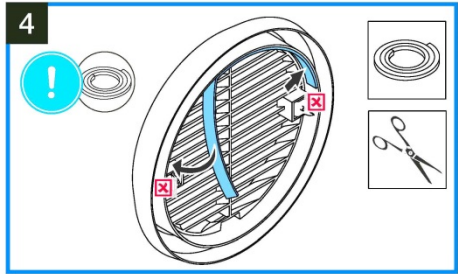
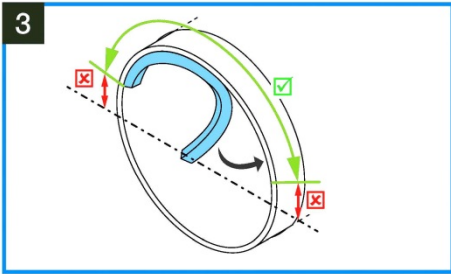
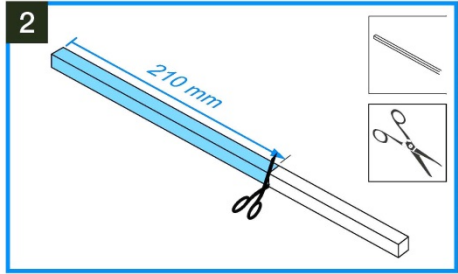
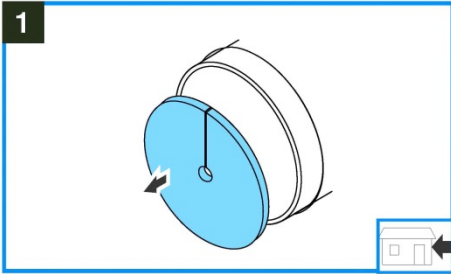

Installing the thermal accumulator insert and connecting the reversible fan

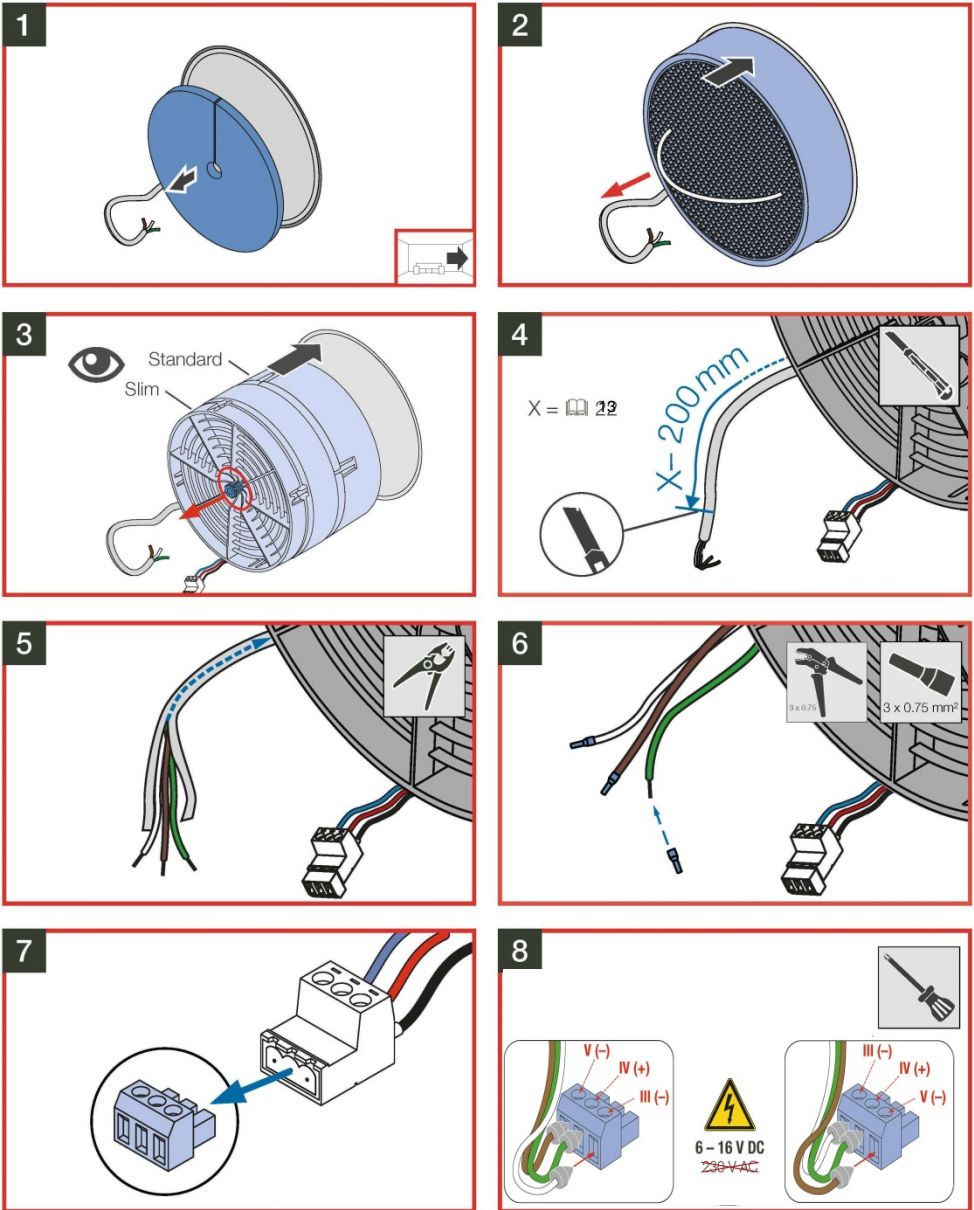

Connecting the fan BUS to the reversible fan

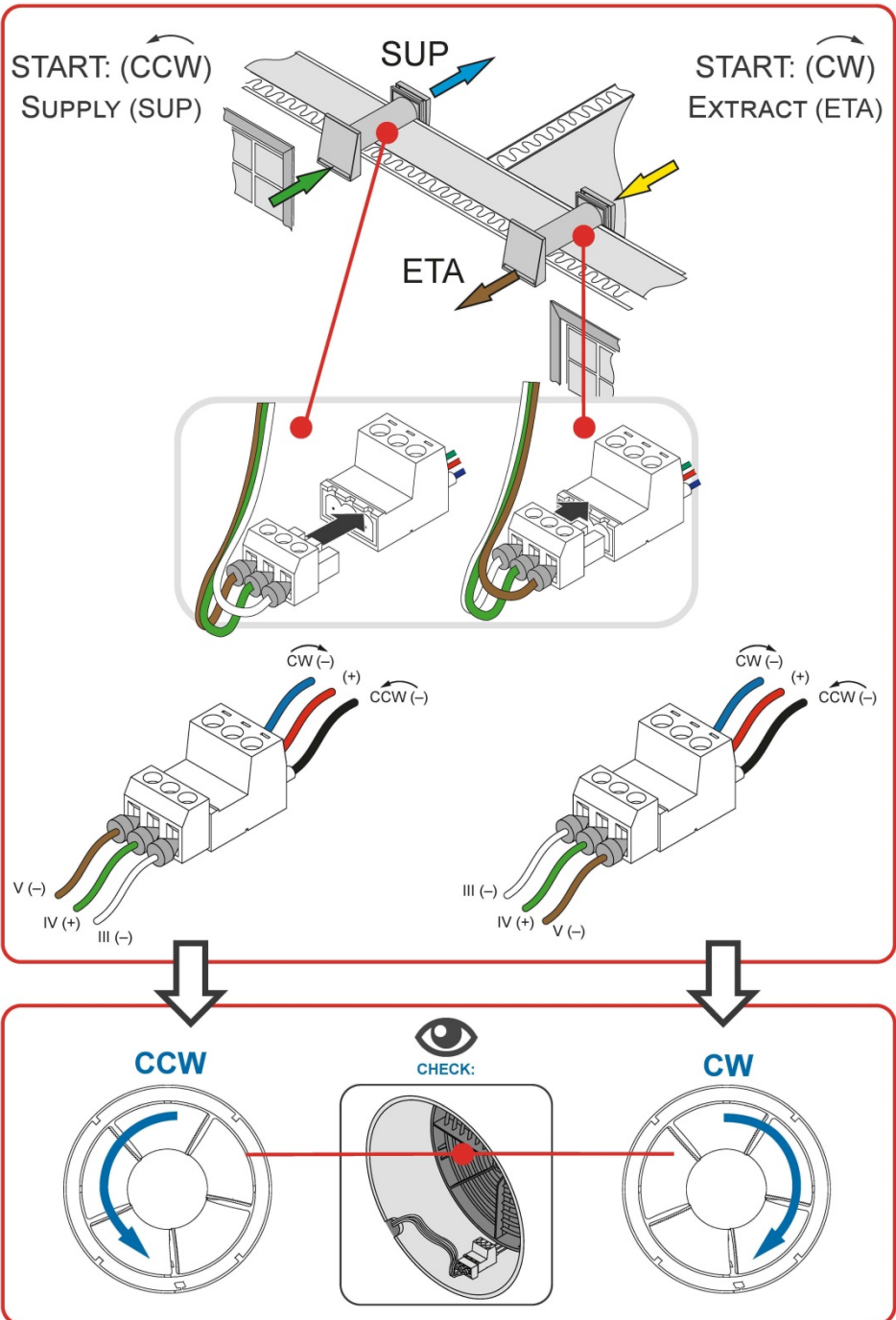

Attaching the inner cover

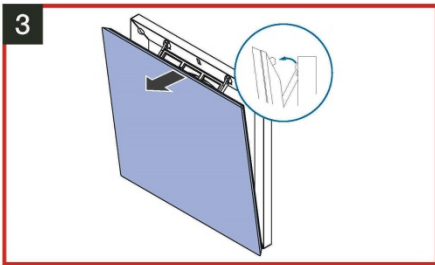
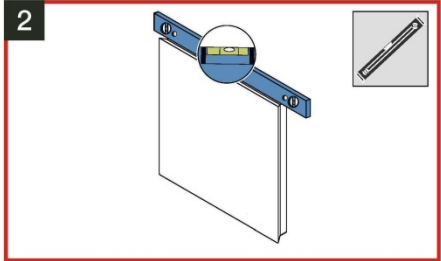
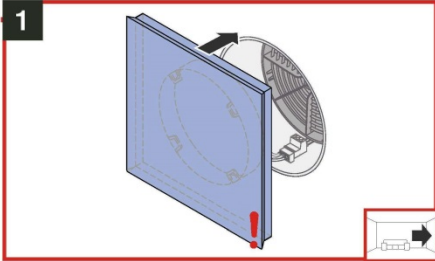

OPTION 1a + 2a:

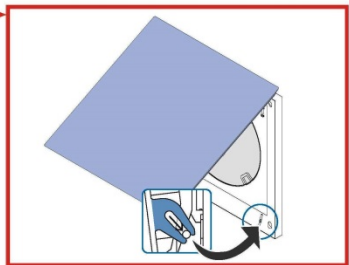
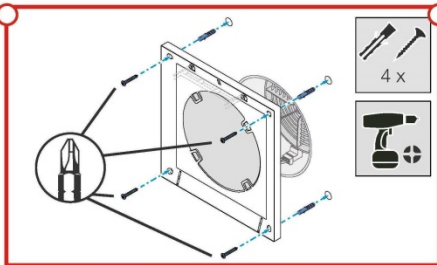

3 Operation of the Heat Save ventilation unit

3.1 Opening/closing the inner cover

For correct functioning of your ventilation system the ventilation unit's inner cover must be opened.

Close the inner cover if you take the ventilation unit out of operation. This will prevent an undesired air exchange, i.e. an inflow of cold air into the living room. Closing the inner cover is particularly easy due to the integrated quick-lock.

In particular situations (i.e. accidents with smoke or leaking gases) it is necessary to close all doors and windows. In these situations your ventilation units must be disconnected from the power supply and all inner covers must be closed as well.

Re-open the inner cover before taking the ventilation unit into operation again.

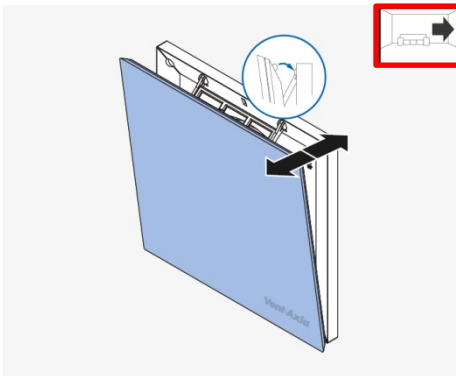

Requirements: The inner cover is attached.

Closing the inner cover:

- ▶ Press the inner cover panel on its upper edge onto the base plate in the direction of the interior wall.
⇒ The quick-lock snaps in.

Opening the inner cover:

- ▶ Pull the inner cover panel on its upper edge into your direction until the quick-lock audibly releases.

⇒ You have opened/closed the inner cover.

4 Operating the SENWZP Sentinel Kinetic Zone Controller

Operating mode, output level and further functions, i.e. pause function, are adjusted via the SENWZP Sentinel Kinetic Zone Controller.

It is operated by touching the capacitive button and the slide control on the control panel. With its integrated indicator lights, the control panel also serves as a display surface.

In addition to pause mode, the controller provides the option to switch off the ventilation unit completely.

4.1 Design and features

Control panel

The control panel is located on the front of the control unit and also serves as a display surface. It is composed of capacitive buttons and various indicator lights. It is operated by touching the various buttons (marked in grey in figure 2).

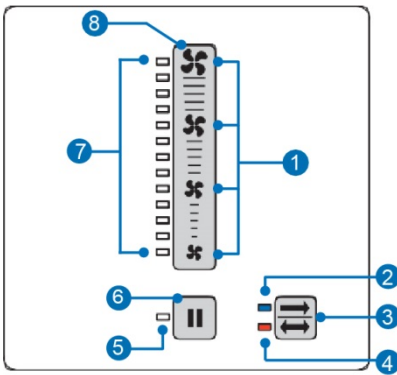

- 1 Marker for output levels 1 – 4
- 2 Continuous ventilation mode (blue) indicator light
- 3 Operating mode button
- 4 Heat recovery mode (orange) indicator light
- 5 Pause/Off indicator light
- 6 Pause/Off button
- 7 Output level indicator lights
- 8 Slide control

Figure 2: Operating and display elements on the control panel

Slide control:

Briefly pressing the fan symbol allows you to select one of the four specific output levels. Touching the slide control for approx. one second lets you continuously adjust the output level by moving it. The position of the illuminated display on the left side of the slide control indicates the currently set output level.

Mode button:

Pressing again lets you switch between the heat recovery and ventilation modes. The indicator lights to the left of the Mode button displays the currently set mode.

The output level of the ventilation unit can be adjusted in all operating modes.

Output level	Symbol	AirFlow %
1		25
2		35
3		50
4		100

Pause / Off button:

A brief press of the controller allows you to switch to the pause function. In the standard version, pressing the button for 5 seconds allows you to completely switch off all ventilation units connected to the controller. Pressing it again switches the connected ventilation units back on. In Flat version the ventilation unit cannot be shut off completely (Switch-off lock).

Function**SENWZP Sentinel Kinetic Zone Controller without connected interface**

If the external interface is not connected, the mode and the intensity of the air flow can be set on the controller.

The heat recovery and continuous ventilation modes can easily be set by touching the Mode button. The OFF mode or the pause function can be selected by touching the Pause/Off button. An indicator light next to the button indicates the selected mode.

The intensity of the ventilation can be adjusted continuously by moving the slide control, or in four steps by touching the fan icons on the slide control. The position of the illuminated display on the left side of the slide control indicates the currently set output level.

SENWZP Sentinel Kinetic Zone Controller with connected interface

The external interface is a bi-functional port on the back of the operating unit. It enables the connection of a sensor with a potential-free switching contact (NOC) or the use of an analogue input to integrate the ventilation unit into an existing home automation system.

Connecting the external interface changes the functionality of your controller as follows:

A. Interface as external switching contact

The sensor used must have a potential-free relay contact (NOC). The function settings of the interface are adjusted via the jumper on the back of the operating unit.

The connection of a pressure monitor is necessary in rooms with air-ventilated fireplaces. Consult a chimney sweep/construction planner about this. If the interface is used for a pressure switch, the air pressure in the interior is measured continuously. Once the air pressure exceeds or falls below the safety threshold, the sensor reacts and turns off all connected ventilation units.

If the external interface is used to connect a

- CO₂ sensor, the CO₂ content in the interior is measured continuously.
- humidistat, the relative humidity in the interior is measured continuously.
- VOC sensor, the composition of the air and the resulting air quality are measured continuously.

A CO₂ sensor and a humidistat can be connected to enable local demand control.

Once the respective value exceeds the upper limit or falls below the lower limit, the sensor reacts and switches all connected ventilation units to ventilation mode, output level 4.

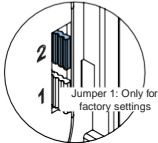
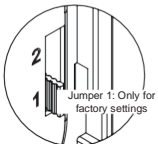
Sensor	Jumper 2 setting	Upper limit exceeded/ switch activated	Lower limit exceeded/ switch deactivated
Pressure switch	Jumper 2 attached (closed) 	Switch all ventilation units connected to the controller to the OFF mode.	Switch all ventilation units connected to the controller to the originally set mode.
CO ₂ Sensor	Jumper 2 not attached (open) 	Switch all ventilation units connected to the controller to continuous ventilation mode, output level 4.	Switch all ventilation units connected to the controller to the originally set mode.
VOC sensor			
Humidistat			

B. Interface as analogue input

If the interface is used as an analogue input, the ventilation unit can be integrated into an existing home automation system. To do so, a predefined voltage level is set in the home automation control unit, depending on the desired function.



TIP: It is not possible to connect a potential-free switch and an analogue input simultaneously. A connected analogue input always has priority over a potential-free switching contact. The jumper on the back of the operating unit must not be attached.

Depending on the control voltage, the following functions are available:

Function	Fan voltage [V DC]
Continuous ventilation output level 4	$0.00 \leq U \leq 0.25$
Continuous ventilation output level 3	$0.75 \leq U \leq 1.25$
Continuous ventilation output level 2	$1.75 \leq U \leq 2.25$
Continuous ventilation output level 1	$2.75 \leq U \leq 3.25$
OFF	$3.75 \leq U \leq 4.25$
Heat recovery output level 1	$4.75 \leq U \leq 5.25$
Heat recovery output level 2	$5.75 \leq U \leq 6.25$
Heat recovery output level 3	$6.75 \leq U \leq 7.25$
Heat recovery output level 4	$7.75 \leq U \leq 8.25$

42 Activating the controller

After activating the controller (e. g. after a power cut), the heat recovery mode will be active.

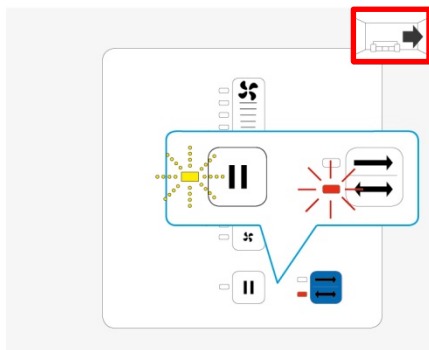

Requirements:

The controller is switched off.

- ▶ Press the button .
 - ⇒ The orange heat recovery indicator light is illuminated.
 - ⇒ The white Pause/Off indicator light flashes.
 - ⇒ The controller is in heat recovery mode.
 - ⇒ The reversible fan is switched off.
-
- ⇒ You have activated the controller.
 - ⇒ You can switch modes and change the output level.

If no change is made after the controller is activated, the controller will switch on the reversible fans at the lowest output level after 60 minutes.

4.3 Setting mode

Setting "heat recovery" mode

In this mode the reversible fans of ventilation units in paired operation change direction at

70-second intervals. The integrated thermal accumulator charges itself with heat energy from the room's air as it flows to the exterior (extract air). When the reversible fan changes direction, it releases the stored heat energy into the incoming outside air (supply air). This operation is the ventilation unit's standard operating mode.

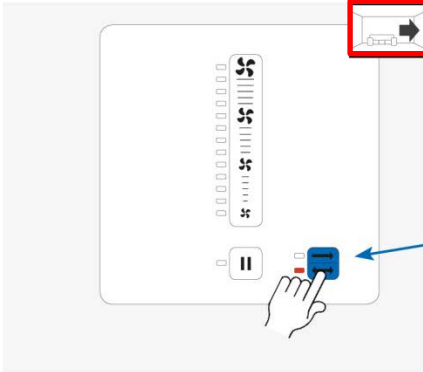

Requirements: The controller is switched on.

- ▶ Press the button  until the orange LED on the left side of the button is illuminated:

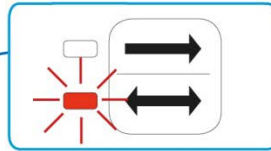

⇒ You have selected "heat recovery" mode.

Setting "continuous ventilation" mode

The ventilation unit's reversible fan works without changing direction. Thus, no heat recovery takes place in this mode. The continuous ventilation unit must be set to supply air mode.

This mode is recommended for cooling the room during summer nights, as well as for quick extraction of stale or moist air.

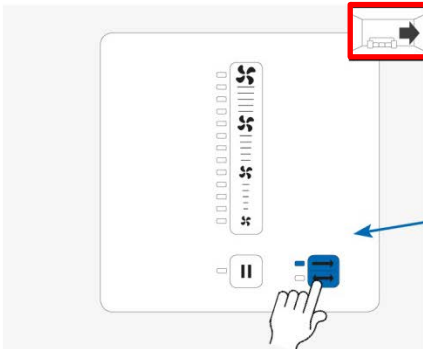

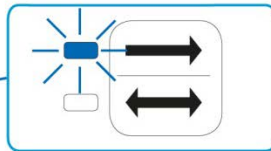

Requirements: The controller is switched on.

- ▶ Press the button  until the blue LED on the left side of the button is illuminated:



⇒ You have selected "continuous ventilation" mode.

 **TIP:** Pressing the button  again lets you switch between the "heat recovery" and "continuous ventilation" modes.

Setting "pause" mode

When setting the pause function, the controller will first switch off the connected ventilation units. After 60 minutes, all ventilation units connected to the controller will restart in heat recovery mode at 25% of the maximum output level.

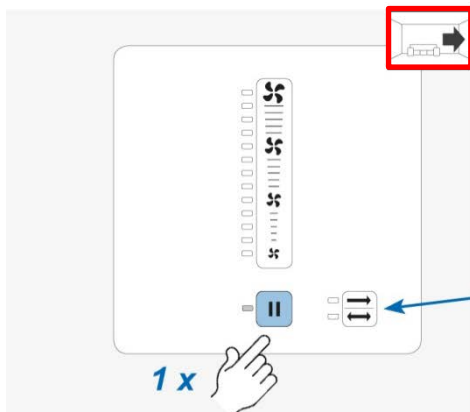

Requirements:

The controller is in heat recovery or continuous ventilation mode.

Press the button 

⇒ The white Pause/Off indicator light flashes.

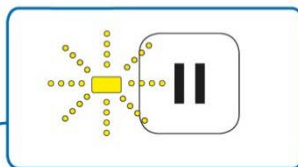

⇒ You have set the pause mode



TIP: In the standard version, when the button  is pressed for longer than five seconds the controller will switch to OFF mode. The indicator light is permanently lit.

Setting OFF mode (only standard version)

The ventilation unit's fan is switched off when the mode is selected. If the controller is switched on, the controller must be activated again.

NOTICE: In Flat version the ventilation unit cannot be shut off completely.

Requirements:

The controller is in heat recovery or continuous ventilation mode.

► Press the button  longer than 5 seconds.

⇒ The white Pause/Off indicator light is permanently lit:

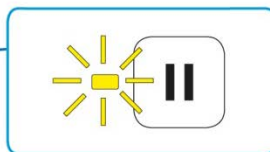
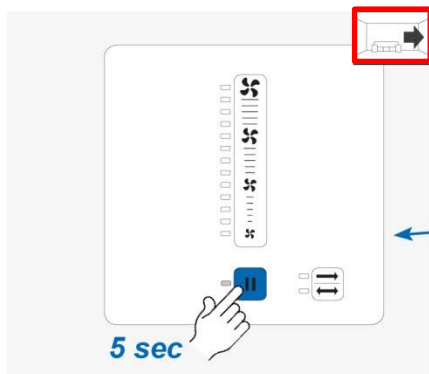

⇒ You have shut off the controller.

4.4 Set output





The intensity of the ventilation can be adjusted continuously by moving the slide control, or in four steps by touching the fan icons on the slide control. The fan icons on the slide control indicate output levels 1 (25 %), 2 (35 %), 3 (50 %) and 4 (100 %). They serve as a guide. The new setting takes effect immediately, so that adjustments can be made purely by listening to changes in the sound level.

Setting the output with predefined levels

Requirements:

The controller is in heat recovery or continuous ventilation mode.

- ▶ Press the button with the symbol matching the desired output level, e. g. level 3:

-  Fan output 100 % (level 4)
-  Fan output 50 % (level 3)
-  Fan output 35 % (level 2)
-  Fan output 25 % (level 1)

⇒ The indicator light to the left of the selected fan icon will be illuminated.

⇒ You have set the predefined output level.

Set continuous output adjustment

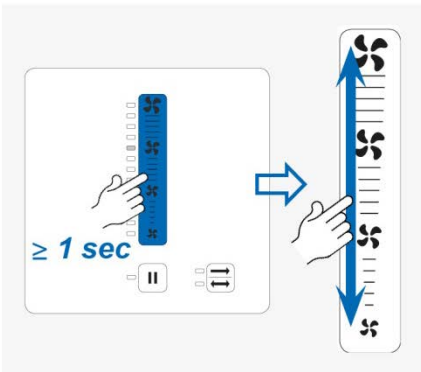

Requirements:

The controller is in heat recovery or continuous ventilation mode.

- ▶ Place your finger on the slide control for 1 second.
 - ⇒ The slide control is now active.
- ▶ Move your finger on the slide control to the desired output level.
 - ⇒ The indicator light to the left of the slide control displays the output level set.

⇒ You have set continuous output adjustment.



The 10th LED on the slider's left side marks 70 % output level. It can only be chosen when setting the output continuous.

4.5 View hours run

The controller comes with an integrated hours-run counter. The operating time is displayed in days. The maximum displayable number is 4,000 days. One day corresponds to a calculation period of 24 hours. There is no further split within these 24 hours.

The operating time is displayed as a 4-digit number.

Every digit, beginning with the first place, will be individually displayed by an indicator light to the left of the slide control/pause button  .

The indicator light to the left of the button corresponds to the number 0.

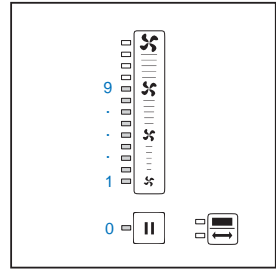

The indicator lights to the left of the slide control correspond to the numbers 1 (bottom) to 9 (top).

When the number is displayed, the end value will be permanently lit. To simplify the numbering, a number of running lights corresponding to the end value will move towards the end value.

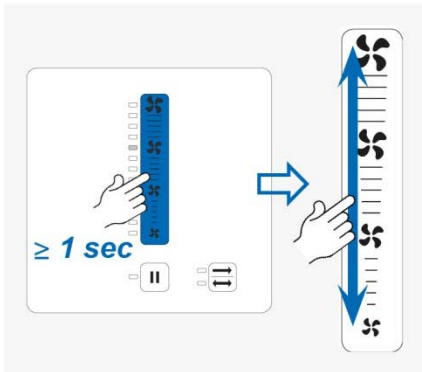

The display disappears between the individual numbers.



▶ Press the  and  simultaneously for 10 seconds until the display lights switch off.

▶ Note down the digits displayed

▶ Combine the digits into a number:
 Number in 1st place = first digit displayed
 Number in 2nd place = second digit displayed
 Number in 3rd place = third digit displayed
 Number in 4th place = fourth digit displayed

⇒ You have requested the days of operation for the controller.

Example

Number's position	Indicator light	Digit
first place	left of the pause button	0
second place	End value: 4th indicator light to the left of slide control 4 running lights move to the end value	4
third place	left of the pause button	0
fourth place	End value: 7th indicator light to the left of slide control 7 running lights move to the end value	7

⇒ The controller has been in operation for 0-4-0-7 days (407 days).

5 Cleaning and maintenance

The Heat Save ventilation units and the SENWZP Sentinel Kinetic Zone Controller is virtually maintenance-free. Any necessary cleaning or maintenance work can be carried out by the user by following these instructions.



TIP: Before performing cleaning or maintenance tasks, disconnect the controller's power supply and put on gloves.

Detergents



NOTICE: The plastic/glass surface of the inner panel/controller is not scratch-resistant and may be damaged.

-
- Do not use sand, soda, acid or chlorine-based cleaning agents.
-

A commercially available detergent in warm water can be used for cleaning. The following tools may be used for cleaning:

- lint-free, soft cloth
- soft brush
- Vacuum cleaner

Recommended maintenance

The maintenance tasks and intervals listed here are recommended to maintain the functionality and performance of the system.

Depending on requirements and/or air quality, your personal maintenance plan may deviate from these recommendations.

Interval	Assembly	Maintenance activity
Cleaning from the interior room		
Monthly	Inner cover	Clean the surface of the panel with a damp cloth.
	Controller	Clean the acrylic glass cover and side surfaces with a damp cloth. Brush the ventilation slots free.
Quarterly	Dust filter	Wash the dust filter with warm water and detergent. Or Replace defective dust filters.

Interval	Assembly	Maintenance activity
Half-yearly	Thermal accumulator	Remove the thermal accumulator and clean it under running warm water.
	Guiding vanes	Remove the guiding vanes from the fan. Clean the guiding vanes using a soft brush or under warm running water.
	Reversible fan	Clean the fan blades with a brush.
	Wall sleeve	Clean the surface of the wall sleeve with a damp cloth.
	Sound absorbing insert	Gently pat off the sound absorbing insert.
Yearly	Inner cover base plate	Clean the surface of the base plate with a damp cloth.
Cleaning from the exterior		
Yearly	Exterior closure: weather protection grille	Clean the surface of the cover and the protective grille with a damp cloth.

5.1 Cleaning/replacing dust filters



TIP: The dust filters are highly durable and can be washed repeatedly. We recommend cleaning the dust filter regularly.

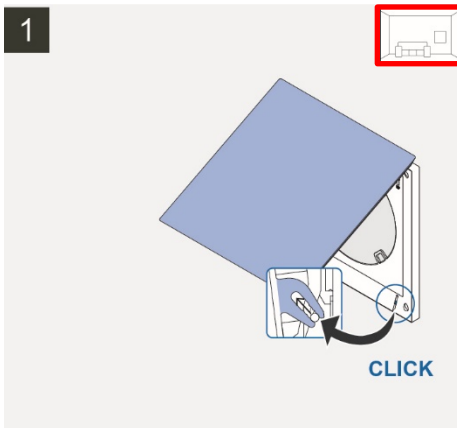

Requirements:

The reversible fan is switched off on the controller.

- ▶ Audibly release the panel from the base plate's bottom locking hooks.
- ▶ Lift the panel upwards.

2

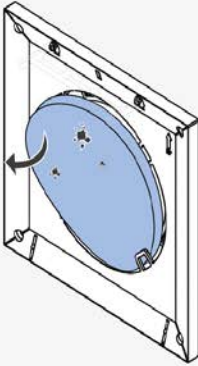

- ▶ Pull the contaminated filter out of the filter holder on the base plate.
- ⇒ The dust filter has been removed.

3

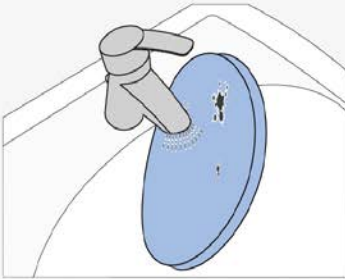

- ▶ Clean the dust filter under warm running water.
- ▶ Wait until the filter is completely dry.
- or**
- ▶ Dispose of the dust filter if defective.

4

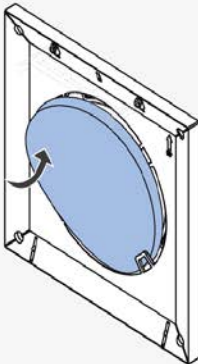

- ▶ Insert a new **or** cleaned dust filter into the filter holder on the base plate.
- Ensure you position the filter firmly between the holders. The cross-section of the wall sleeve is covered.

5

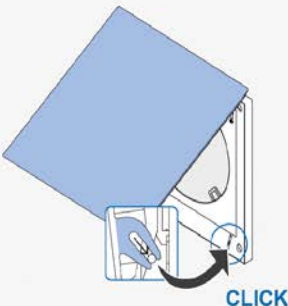

- ▶ Fold the panel back downwards.
- ▶ Audibly snap the panel into the base plate's bottom locking hooks.

⇒ You have cleaned/changed the dust filter.

52 Removing the thermal accumulator insert



Pen to mark the connector orientation

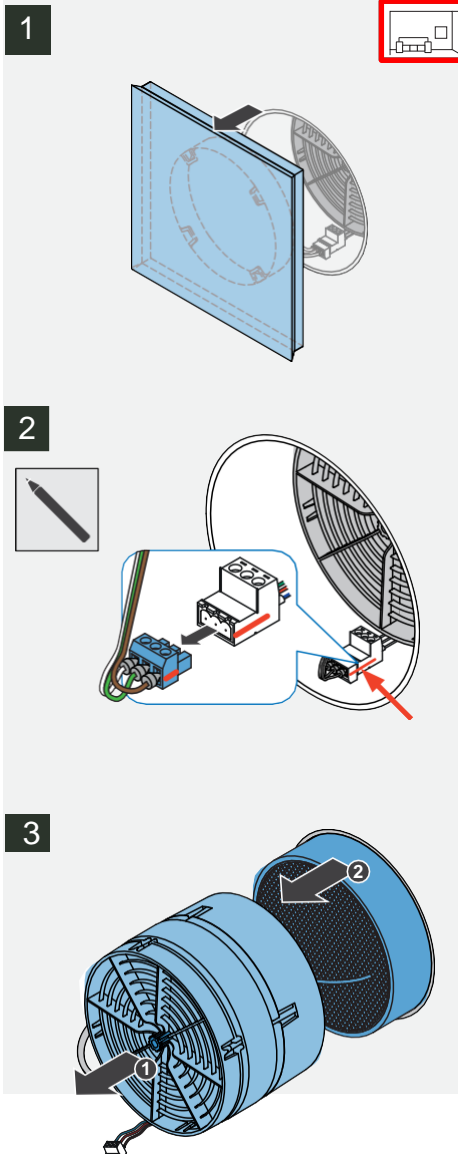

Requirements:

The reversible fan is switched off on the controller.

- ▶ Close the inner cover.
- ▶ Remove the complete inner cover from the wall sleeve.

- ▶ Disconnect the BUS connector



NOTICE: In case of damage to the ceramic thermal accumulator it will no longer function!

- Do not throw the ceramic thermal accumulator.
- Store the thermal accumulator in the standing position outside the wall sleeve.

- ▶ Step 1: Remove fan assembly from the wall sleeve by the knob.
- ▶ Step 2: Remove the thermal accumulator from the wall sleeve by the handle.

⇒ You have removed the thermal accumulator insert.

53 Cleaning and reassembling the thermal accumulator insert



Soft brush, lint-free soft cloth and warm water

Requirements:

The thermal accumulator insert has been removed.



NOTICE: Incorrect cleaning of the thermal accumulator will result in damage to the insulation on the thermal accumulator.

- Always clean the thermal accumulator under warm running water.

Never clean it in the dishwasher.

- ▶ Clean the thermal accumulator under warm running water.
- ▶ Let the thermal accumulator drip dry.
- ▶ Wait until the thermal accumulator is completely dry.

⇒ You have cleaned the thermal accumulator insert.



NOTICE: When breaking the attachment strips on the guiding vane, the guiding vane can no longer be attached to the fan!

- Carefully bend the strips away from the guiding vane.
- If you can feel resistance, stop bending the strips outwards.

- ▶ Place fan assembly on an even surface.
- ▶ Remove the slim guiding vane from the fan.

Step 1: Carefully bend the lateral strips on the guiding vane away from the fan one after the other.

Hold the first removed strip in the current position with one hand until the guiding vane is completely removed.

⇒ The guiding vane is separated from the fan

Step 2: Lift the guiding vane upwards.

- ▶ Turn the fan so that the remaining guiding vane is pointing upwards.
- ▶ Remove the guiding vanes from the fan.
 - ⇒ Remove the remaining guiding vane as previously described.

1



2

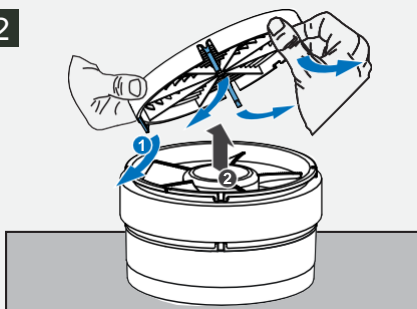

3

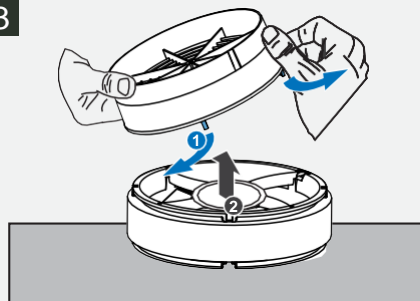

4

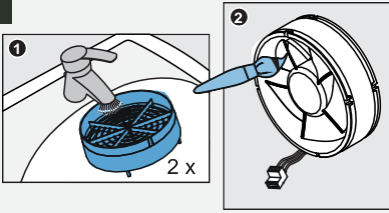

- ▶ Step 1: Clean both parts of the guiding vane carefully with a soft brush or under warm flowing water.
- ▶ Let the guiding vane drip dry. Wait until the guiding vane is completely dry.
- ▶ Step 2: Clean the reversible fan carefully with a soft brush.

5

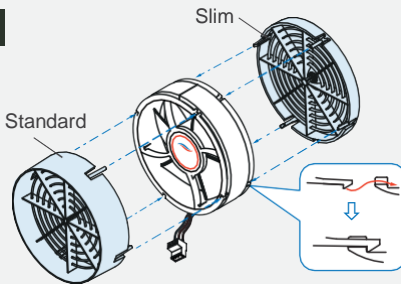

- ▶ Reattach the guiding vanes to the reversible fan. **Ensure** that the smaller Slim guiding vane is located on the side **WITHOUT** type plate.

⇒ You have removed the thermal accumulator insert.

6

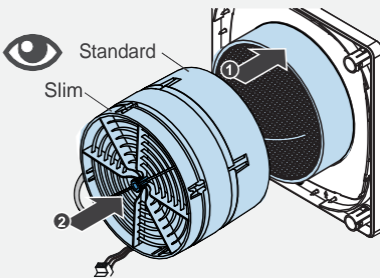

- ▶ Step 1: From the interior, slide the thermal accumulator into the wall sleeve as far as the end stop tape. **Make sure** that the handle is facing towards the interior.
- ▶ Step 2: Insert fan assembly into the wall sleeve so that you can reach both cables. **Ensure** that the narrow Slim guiding vane is facing towards the interior.

7

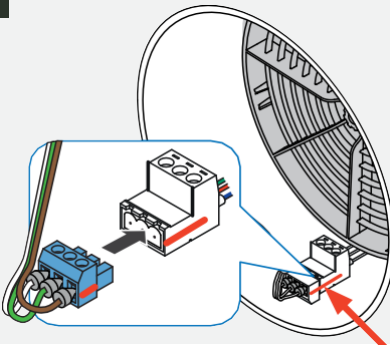

- ▶ Connect the wired plug to the BUS connector.

- ▶ Slide fan assembly as far as the thermal accumulator.

⇒ You have cleaned and re-installed the thermal accumulator insert.

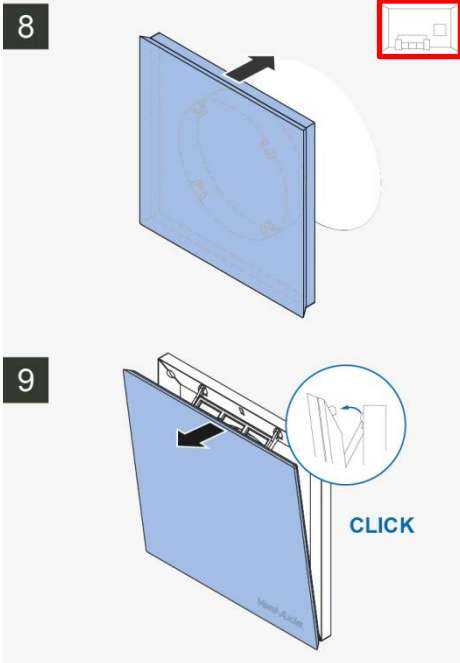

► Re-insert the inner cover completely into the wall sleeve.

Ensure that the Vent-Axia logo is located on the bottom right).

► Pull the inner cover panel on its upper edge into your direction until the quick-lock audibly releases.

⇒ You have cleaned and re-installed the thermal accumulator insert.

6 Troubleshooting and disposal

Troubleshooting

If your ventilation units or controllers are not functioning properly, consult the following troubleshooting table. If the fault persists, contact your supplier, distributor or the technical service department at Vent-Axia .

Malfunction	Possible cause	Remedy
Fan failure	No electrical power.	Check fuse.
	Installation error.	Check wiring for correct polarity. Check all connectors for correct fit.
	Fan defective.	Replace fan.
	Controller/power supply unit defective.	Replace controller/power supply unit.
Fan does not switch off.	Faulty controller.	Replace controller.
Low air flow	Inner cover closed.	Open inner cover panel.
	Dust filter heavily soiled.	Clean/replace dust filters.
	Micro filter inserted.	The addition of a micro filter reduces the flow rate. Only use a micro filter during periods of heavy pollution. Replace filter if heavily soiled.
	Fans are not operating in paired mode.	Connect the first fan in extract air mode and the second fan in supply air mode.
	Fan speed is too low.	Increase the output level.
	Thermal accumulator is soiled.	Clean the thermal accumulator.
Noises	Foreign body in the fan.	Remove foreign body from the fan. Clean the ventilation unit.
	Fan blades soiled.	Clean fan blades.
	Thermal accumulator is not correctly positioned in the wall sleeve.	Slide the thermal accumulator out of the wall sleeve. Insert it again. Slide the thermal accumulator into the wall sleeve as far as the end stop tape.
	Fan speed very high.	Set a lower output level on the controller.

Malfunction	Possible cause	Remedy
Supply air is cold	Installation error.	Check the connector plug on the controller. The connector plug must be sitting firmly in the connector housing.
		Make sure, that the fan's type plate is situated in direction of the thermal heat accumulator.
	The controller is operating in continuous ventilation mode.	Select heat recovery mode on the controller.
Wrong controller function when interface is connected	Upper jumper is incorrectly/ not connected	Check position of the jumper on the back of the operating unit: Attached: Operating mode OFF Not attached: Ventilation mode
Controller does not function.	Operating unit is incorrectly/ not connected.	Check wiring.
	No electrical contact.	Check cables. Ensure cables are stripped sufficiently (approx. 8.5 mm).
Indicator lights do not light up.	Faulty controller.	Replace controller.
	There is no power.	Check power supply.
Slide control defective.		Replace controller.

Disassembly

Disassemble the ventilation unit in the opposite sequence to the assembly sequence. You can subsequently dispose of your old device. Please note the disposal recommendation outlined below.



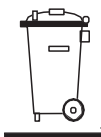

Disposal



The products described in these installation and operating instructions contain valuable materials which can be recovered and recycled. Further information about the used materials are provided in the corresponding installation instructions.

The separation of waste materials into different varieties facilitates recovery of the recyclable materials. Contact an electronic appliance disposal company to arrange environmentally friendly recycling and disposal of your old system. They will dispose of the product in compliance with the applicable national regulations.

7 Specifications

Feature		Value
Heat Save ventilation unit		
Operating range [°C]		-20 – 50
Air flow in reverse operation (push-pull) per unit [m³/h]		5 – 21
Extract air flow per unit [m³/h] (EN 13141-8)		10 – 42
Sound pressure level [dB (A)]		18 – 36
Standard sound level difference [dB]		34 – 47
Heat recovery [η'_{w}]		\varnothing 0.82 / Max. 0.86
Input voltage [V DC]		6 – 16
Power consumption [W]		1 – 3
Protection class (EN 61140) / Type of protection (EN 60529)		III / IP20
Filter class (standard filter) (EN 779:2012)		ISO Coarse 60% / PM10 (G4)
Air flow sensitivity at \pm 20 Pa (EN 13141-8)		Class S3
Frost protection		Automatically due to push-pull operation (up to -20 °C)
Energy efficiency class	local demand control	
	manual control	
Conformity		
SENWZP Sentinel Kinetic Zone Controller		
Protection class (EN 61140) / Type of protection (EN 60529)		II / IP20
Input voltage Switching PSU [V AC] [Hz]		230 / 50
Output voltage Switching PSU [V DC]		24
Maximum power consumption s4/s8 [W]		11 / 20
Power consumption (Standby) [W]		< 1
Output voltage fan BUS [V DC]		6.7 – 15.3; 3 pole
Analogue input (optional) [V DC]		0 – 10, Control voltage
External switching contact (optional)		Potential free closer contact (NO)
Operating temperature [°C]		5 – 50
Conformity		

8 Accessories and spare parts

To order parts for your ventilation unit or controller, contact your nearest factory outlet or our service staff.

Spares & Accessories

Component	Stock Ref number
SEWZP Sentinel Kinetic Zone Controller	496037
Heat Save Spare Inner Cover 220x220	496108
Heat Save G4 Filter (PM10)	496038
Heat Save Ext.Wall Sleeve 160x745	495328
Heat Save Spare Wall Sleeve 160x495	496105
Heat Save Spare Reversible Fan	496110
Heat Save Spare Thermal Accumulator	496111
Heat Save Spare Weather Protection Grille	496107
Sound Absorbing Insert VA Heat Save	496109

9 **Guarantee and warranty**

Manufacturer guarantee

Vent-Axia provides a five-year guarantee for all electrical components and the wall mounting sleeve, as well as a thirty-year guarantee on the heat accumulator ceramic. This covers premature product wear.

10 **Service**

Warranty and guarantee claims

In the case of a warranty or guarantee claim, contact your local distributor or factory representative. In all cases, return the complete device to the manufacturer. The guarantee is an additional offer by the manufacturer and in no way affects the applicable law.

Accessories and spare parts

To order parts for your controller, contact your nearest factory outlet or our service staff.

Technical customer service

For technical support contact our service staff.

Tel: +44 (0)344 856 0594

Email: info@vent-axia.com

Vent-Axia®

Head Office: Fleming Way, Crawley, West Sussex, RH10 9YX. Tel: 01293 526062 Fax: 01293 551188

UK NATIONAL CALL CENTRE, Newton Road, Crawley, West Sussex, RH109JA

SALES ENQUIRIES: Tel: 0344 8560590 Fax: 01293 565169

TECHNICAL SUPPORT: Tel: 0344 8560594 Fax: 01293 532814

For details of the warranty and returns procedure please refer to www.vent-axia.com or write to Vent-Axia Ltd, Fleming Way, Crawley, RH10 9YX

EU Authorised Representative: Vent-Axia Bedrijvenweg 17 7442 CX Nijverdal Nederland authorisedrep@vent-axia.nl