

## Plié Shelving System by FROM INDUSTRIAL DESIGN



Inspired by a classical ballet movement that gives strength and perfect posture to the whole body, Plié is a 2019 German Design Award-winning shelving system that offers a versatile solution for organising or displaying your belongings. The shelving system collection includes free standing as well as wall mounted units.

Designed by Cesare Bizzotto and Tobias Nitsche, the Plié uses the least amount of powder-coated aluminium possible which, folded, results in a lightweight, yet highly robust structure. This means that any unit can be assembled with only a handful of components, making it extremely easy to assemble.

Its simple and timeless design language perfectly reflects the character of UTIL. It adapts to any interior, from the contemporary workspace to the private living environments, offering a versatile solution that is designed to last.

## Dimensions and Variations

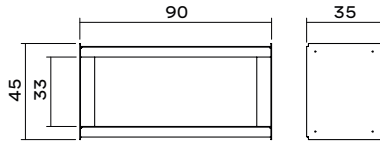

Plié Floor Unit 90 cm

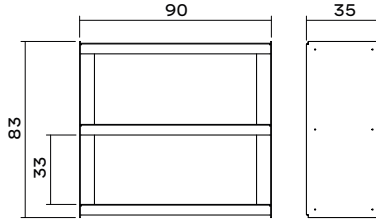

Plié Sideboard 90 cm

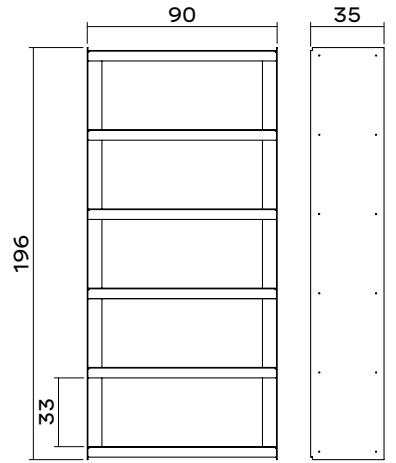

Plié Bookshelf 90 cm

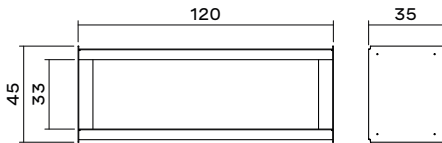

Plié Floor Unit 120 cm

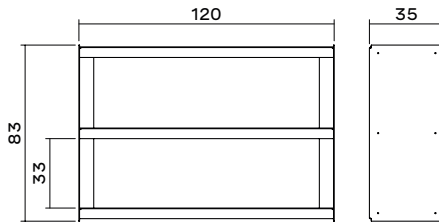

Plié Sideboard 120 cm

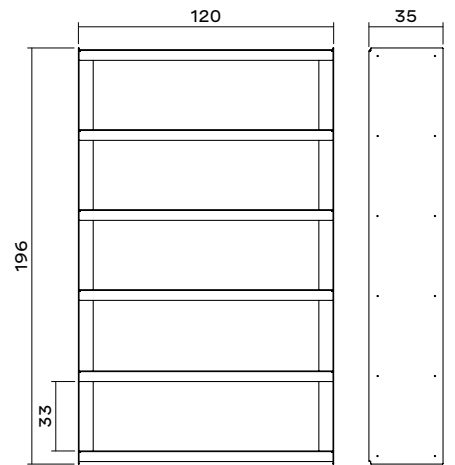

Plié Bookshelf 120 cm

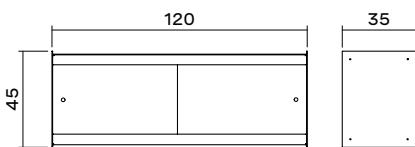

Plié Wall Mount 120 cm

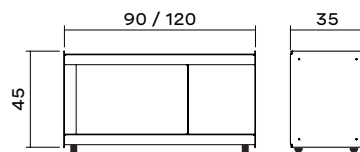

Plié Media Unit

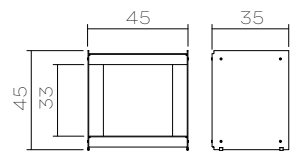

Plié Side Table

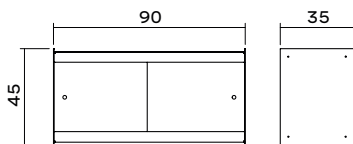

Plié Wall Mount 90 cm

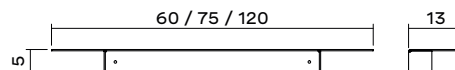

Single Shelf



This is Util Lda  
Rua do Giestal 37B  
1300-275 Lisboa  
Portugal

Tel: +351 919 975 119  
Web: [www.thisisutil.com](http://www.thisisutil.com)  
Email: [contact@thisisutil.com](mailto:contact@thisisutil.com)

## Drawers

## Dimensions and Variations

**Double Drawer 120 cm**  
ref. 1508.120.00.

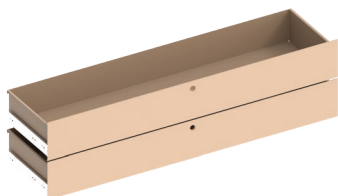

**Single Drawer 120 cm**  
ref. 1509.120.00

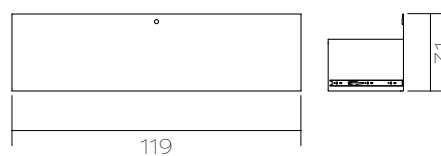
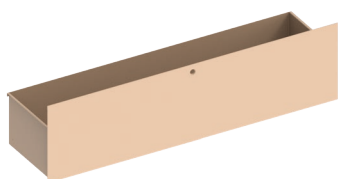

**Double Drawer 90 cm**  
ref. 1508.090.00

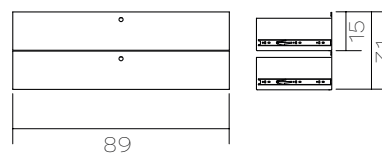
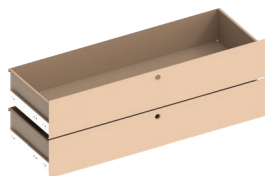

**Double Drawer 120 cm**  
ref. 1509.090.00.

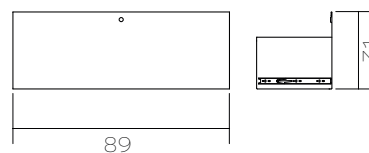
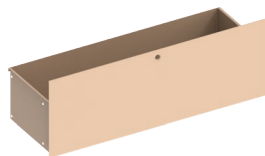

### Assembly of the drawers

- All drawers are easily installed on a new or existing Plié unit.
- It is not necessary to disassemble your existing Plié unit in order to instal the drawers.
- All required tools are included for the assembly alongside an easy step by step instructions manual.



This is Util Lda  
Rua do Giestal 37B  
1300-275 Lisboa  
Portugal

Tel: +351 919 975 119  
Web: [www.thisisutil.com](http://www.thisisutil.com)  
Email: [contact@thisisutil.com](mailto:contact@thisisutil.com)

## Materials

- Aluminum
- Stainless Steel Screws
- Rubber profile for the feet

## Colors and Finishes

Powder coated with fine texture or Smooth matt finish

- Light Grey Fine Texture RAL 7047 Matt
- Beige Fine Texture RAL 1019
- Coral Fine Texture RAL 3020
- Midnight Blue Fine Texture RAL 5008
- Traffic Red Fine Texture RAL 3020
- Ultramarine Fine Texture RAL 5017
- Yellow Fine Texture RAL 1018
- Brushed Aluminium

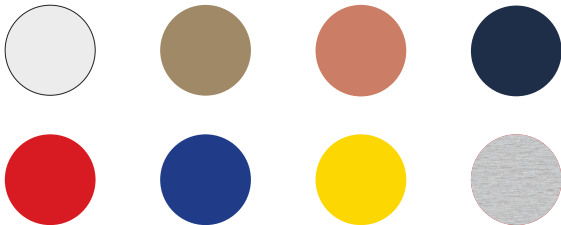

## FROM INDUSTRIAL DESIGN

Is a collaboration between Cesare Bizzotto and Tobias Nitsche. Known for developing innovative and forward-thinking solutions while keeping an edge in their aesthetics, the duo met during their masters degree at ECAL, Switzerland, and have been developing industrial products in the fields of furniture and lighting ever since.

Plié, their shelving system design for UTIL, was awarded the German Design Award for Excellent Product Design in 2019

## Assembly

All required tools are included for the assembly alongside an easy step by step instructions manual.

## Load Capacity

Each shelf can withstand 25Kg of distributed weight. However, make sure the wall installation is correctly made, for the wall mounted units, using the appropriate wall plugs.

## Shipping

All of the Plié variations is shipped via parcel in a flat-packed reinforced cardboard box.

## Care and Maintenance

Always clean with a damp cloth with no solvents.



This is Util Lda  
Rua do Giestal 37B  
1300-275 Lisboa  
Portugal

Tel: +351 919 975 119  
Web: [www.thisisutil.com](http://www.thisisutil.com)  
Email: [contact@thisisutil.com](mailto:contact@thisisutil.com)