

UTIC



2024

INDEX

About UTIL	5
Production	6
Catching up with	8
Plié Wall Mount	10
Plié Wall Mount Extension	14
Plié Sideboard	18
Plié Sideboard Extension	22
Plié Bookshelf	26
Plié Bookshelf Extension	30
Plié Floor Unit	34
Plié Side Table	38
Plié Media Unit	44
Plié Single Shelf	48
Plié Wall Shelves	54
UTIL X JAK Shoe Rack	60
KGT Storage Box	64
KGT Wall Units	70
Basso Trolley	78
Hal Coat Rack	84
Designers	88
Product Specifications	90
Color and Finishes	100

ABOUT

Founded in 2017 and led by Manuel Amaral Netto and Tomás Carvalhas, UTIL is a young Lisbon based design brand with a clear focus on enduring and functional storage furniture made from high quality materials. Transcending product design, UTIL's philosophy of simplifying and focusing on the essential is inspired by people and everyday life, every piece of the formally simple and architectural influenced collection is made to last a lifetime.

UTIL's understated yet unique furniture is designed to be helpful and subtle. Meaning 'useful' in Portuguese, UTIL develops solutions for the increasingly scarce living space in metropolitan areas. The high quality and timeless design of its objects will accompany the user through a lifetime of changing environments. The enduring products are easy to assemble and move around, blending in and adapting to life's ever-changing needs.



PRODUCTION

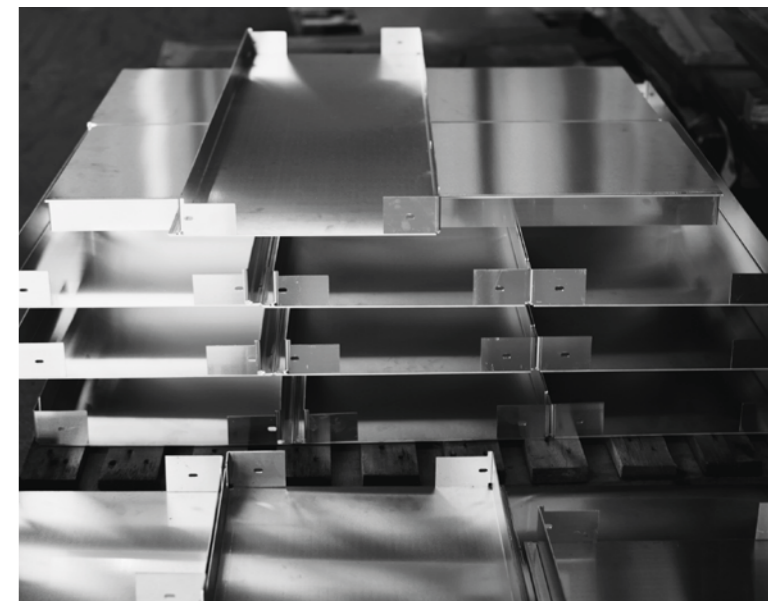

All our products are made locally, in Portugal, renowned for its expertise in various materials and finishes. We continuously push the boundaries of production, striving for elevated standards. The close proximity to our headquarters enables us to closely monitor production quality and adapt our products with greater flexibility



1



2



3

CATCHING UP WITH

"Catching Up With" comprises a series of house visits, enabling us to delve deeper into how individuals integrate our products into their private spaces. Explore further in our Journal.



5



- 1 - Victoire de Lencquesaing, Dec/20, pictures by Pedro Alfacinha
- 2 - Sofia Moser Leitão, Oct/23, Pictures by Matilde Travassos
- 3 - Pedro Alfacinha, Jul/23, pictures by Manuel Netto
- 4 - João Magalhães, Apr/21, pictures by Pedro Alfacinha
- 5 - Catarina Osório de Castro, Feb/24, pictures by Matilde Travassos

PLIÉ WALL MOUNT

Designed by FROM INDUSTRIAL DESIGN

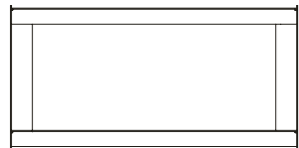
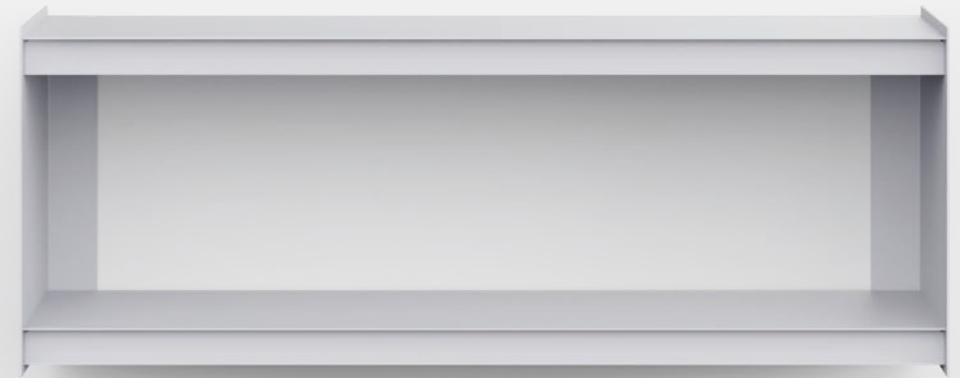

Plié Wall Mount

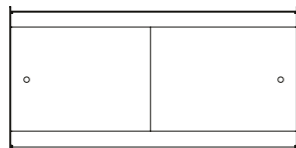

Plié Wall Mount Doors

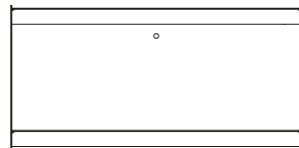

Plié Wall Mount Single Drawer

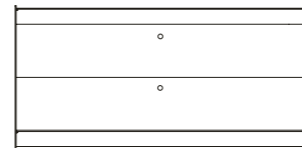

Plié Wall Mount Double Drawer



PLIÉ WALL MOUNT EXTENSION

Designed by FROM INDUSTRIAL DESIGN

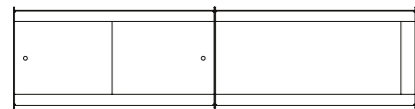

Plié Wall Mount Doors Open

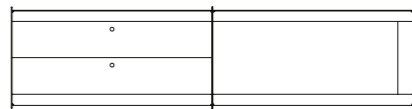

Plié Wall Mount Double Drawers Open

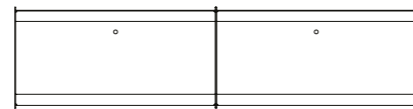

Plié Wall Mount Single Drawers

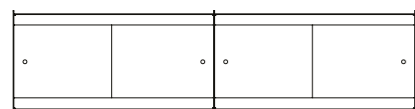

Plié Wall Mount Doors

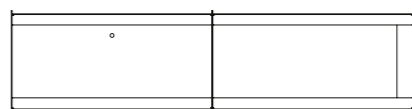

Plié Wall Mount Single Drawer

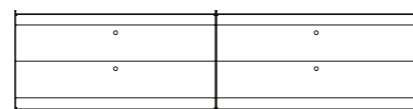

Plié Wall Mount Double Drawers



PLIÉ SIDEBOARD

Designed by FROM INDUSTRIAL DESIGN

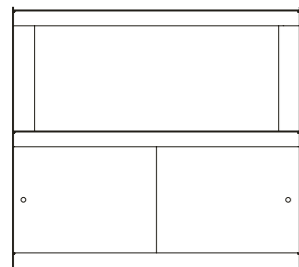

Plié Sideboard Doors

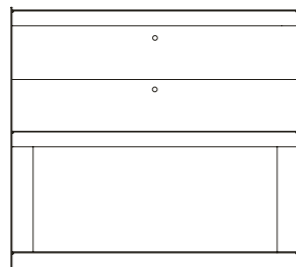

Plié Sideboard Double
Drawers

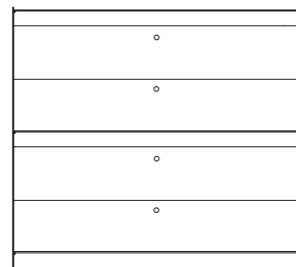

Plié Sideboard Double
Double Drawers

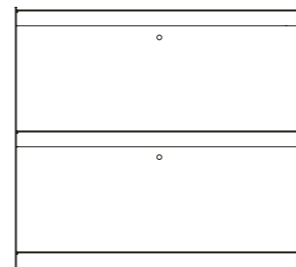

Plié Sideboard Double
Single Drawers

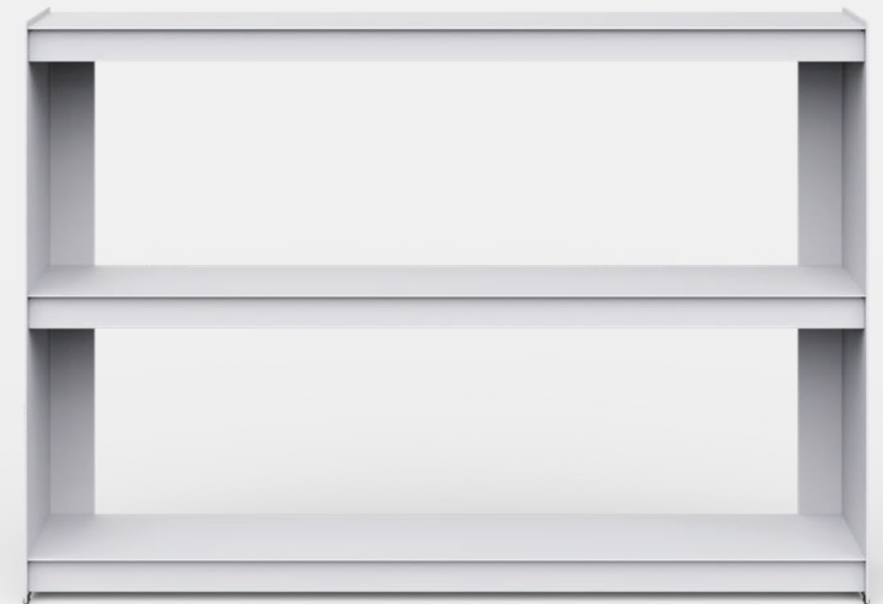



Plié Sideboard with sliding doors in brushed finish



Plié Sideboard with double drawers in Beige

PLIÉ SIDEBOARD EXTENSION

Designed by FROM INDUSTRIAL DESIGN

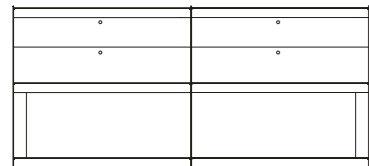

Plié Sideboard Extension Double Drawers

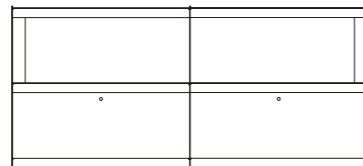

Plié Sideboard Extension Single Drawers

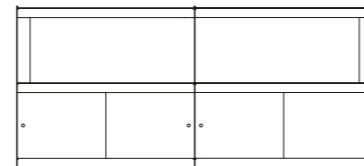

Plié Sideboard Extension Doors

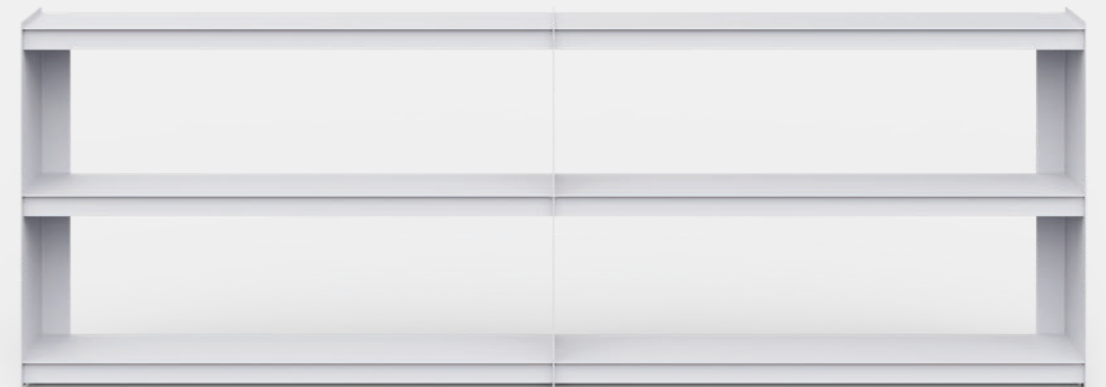



PLIÉ BOOKSHELF

Designed by FROM INDUSTRIAL DESIGN

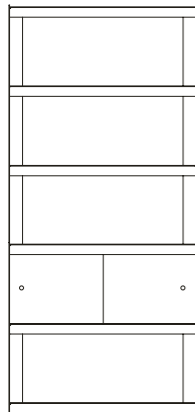

Plié Bookshelf Doors

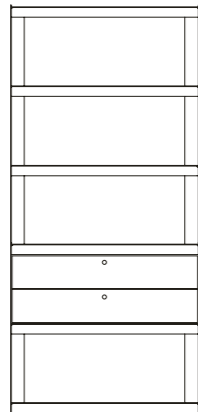

Plié Bookshelf
Double Drawers

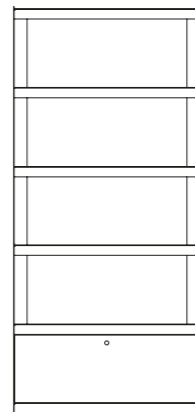

Plié Bookshelf
Single Drawer

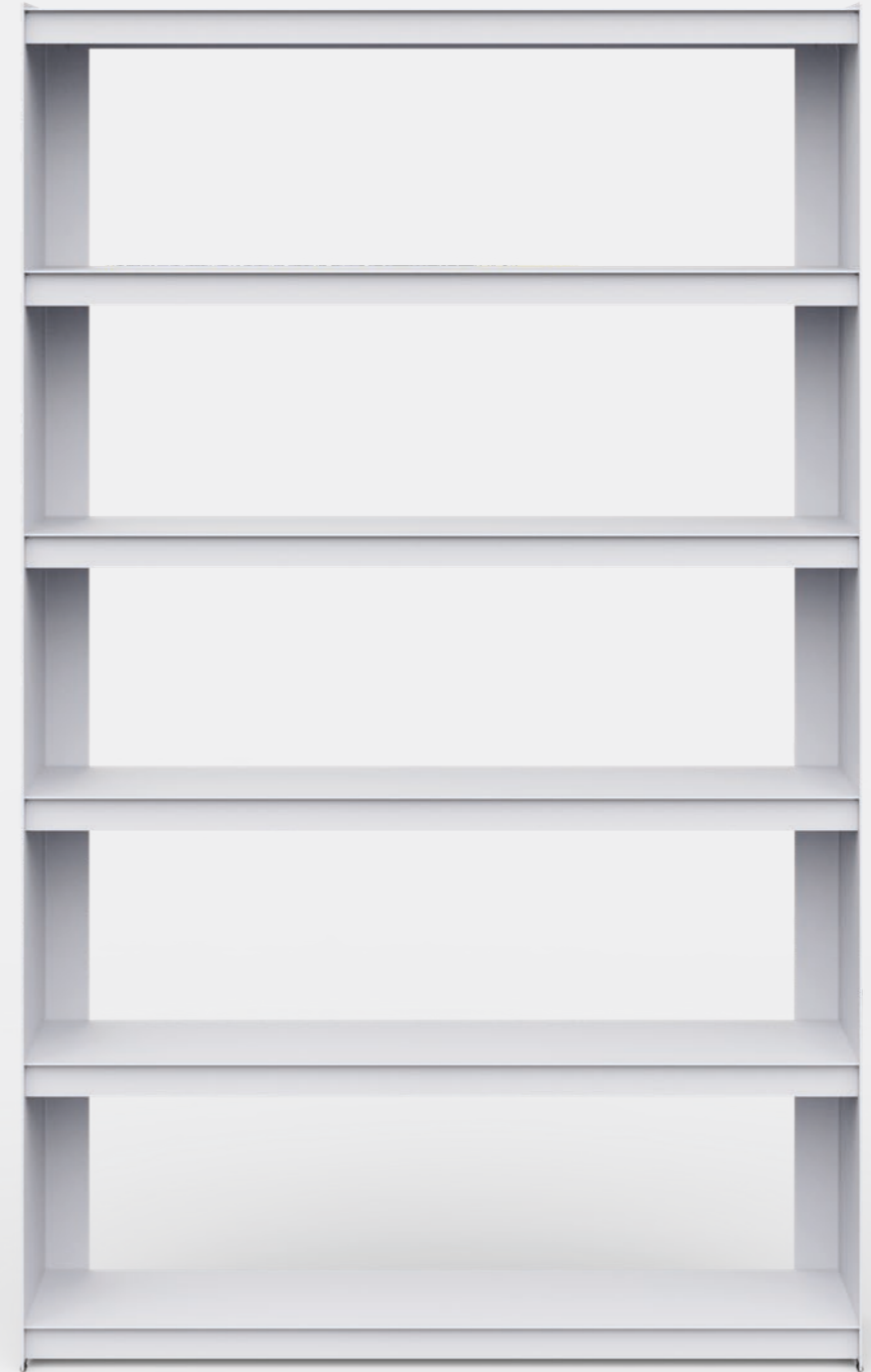



PLIÉ BOOKSHELF EXTENSION

Designed by FROM INDUSTRIAL DESIGN

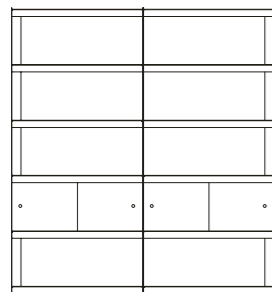

Plié Bookshelf Extension
Doors

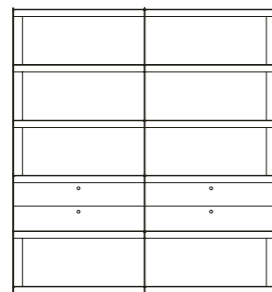

Plié Bookshelf Extension
Double Drawers

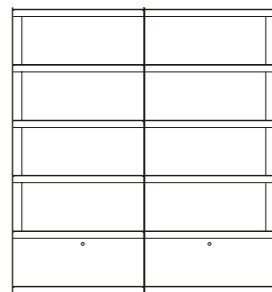

Plié Bookshelf Extension
Single Drawers

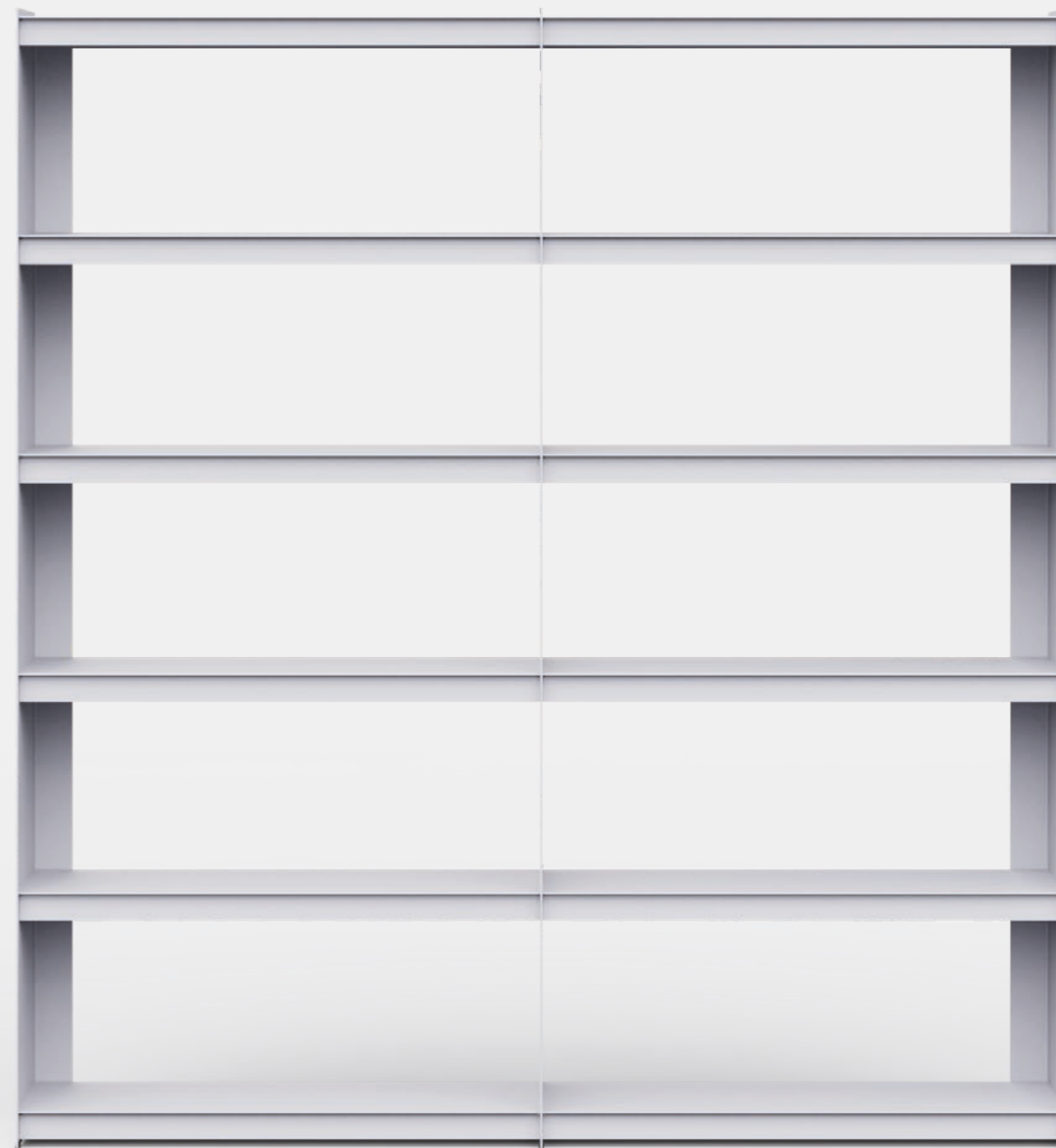



PLIÉ FLOOR UNIT

Designed by FROM INDUSTRIAL DESIGN

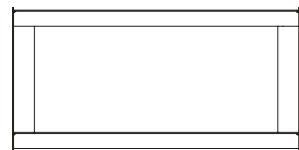

Plié Floor Unit

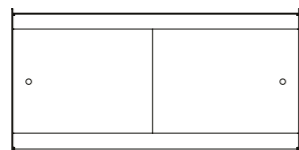

Plié Floor Unit Doors

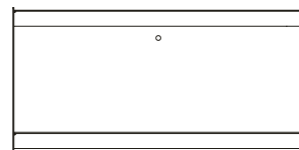

Plié Floor Unit Single Drawer

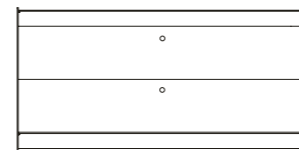

Plié Floor Unit Double Drawer

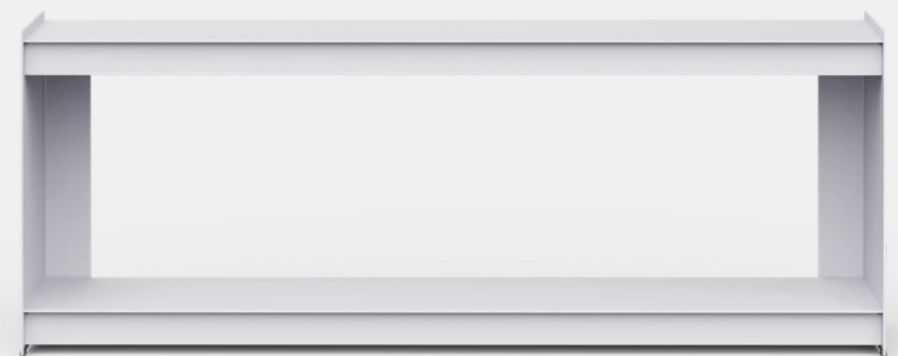



PLIÉ

SIDE TABLE

Designed by FROM INDUSTRIAL DESIGN

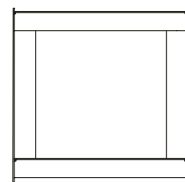

Plié Side Table

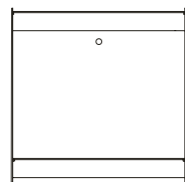

Plié Side Table
Single Drawer

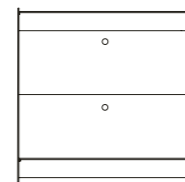

Plié Side Table
Double Drawer







PLIÉ MEDIA UNIT

Designed by FROM INDUSTRIAL DESIGN





PLIÉ SINGLE SHELF

Designed by FROM INDUSTRIAL DESIGN







PLIÉ WALL SHELVES

Designed by FROM INDUSTRIAL DESIGN

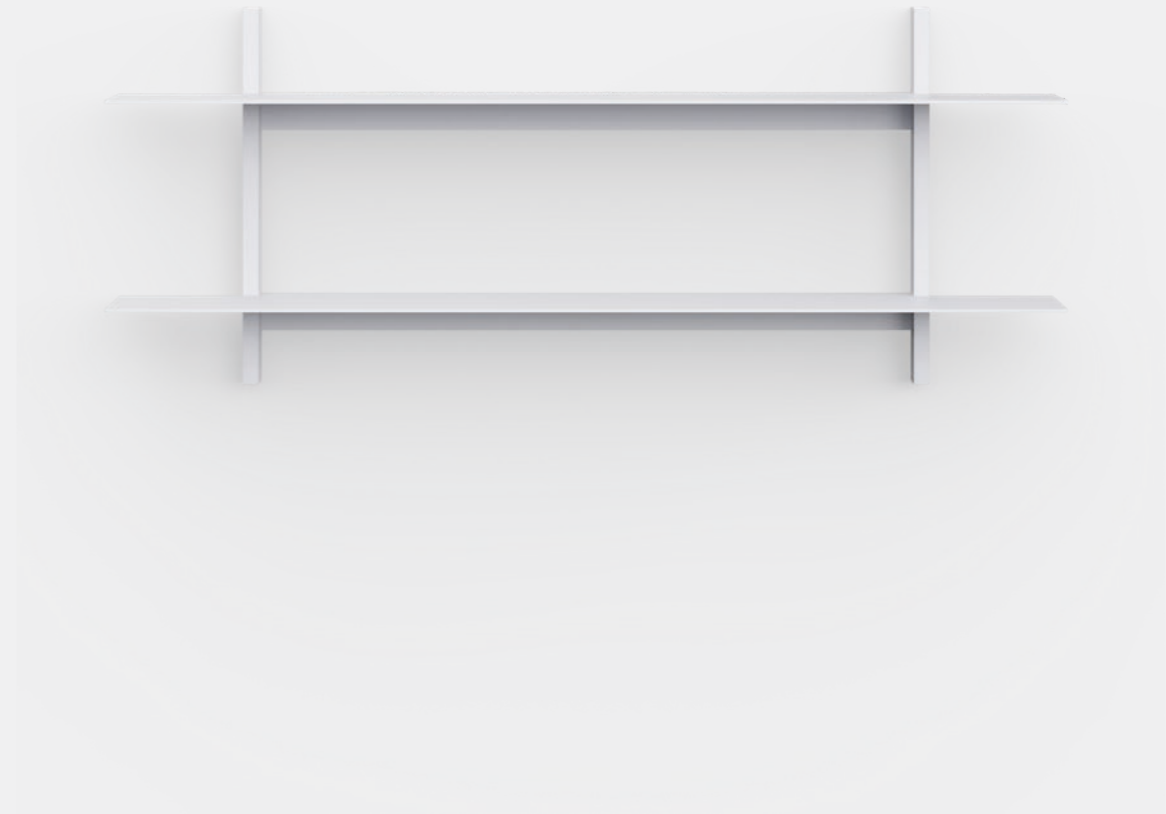





UTIL X JAK SHOE RACK

Designed by Jeanne Mercier

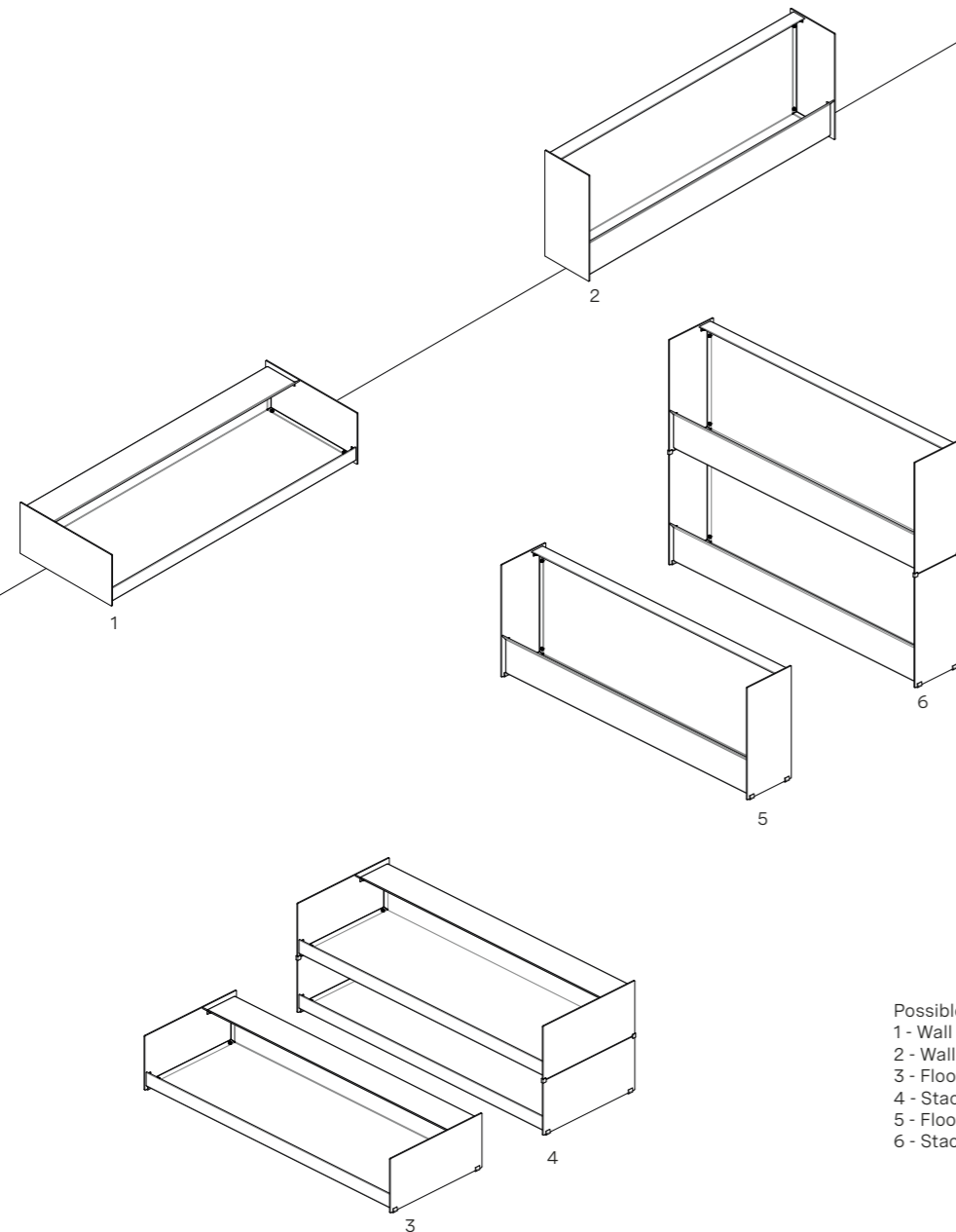

- Possible Uses
- 1 - Wall mounted layed down
 - 2 - Wall mounted upright
 - 3 - Floor layed down position
 - 4 - Stacked layed down
 - 5 - Floor upright position
 - 6 - Stacked upright





KGT STORAGE BOX

Designed by CP RV

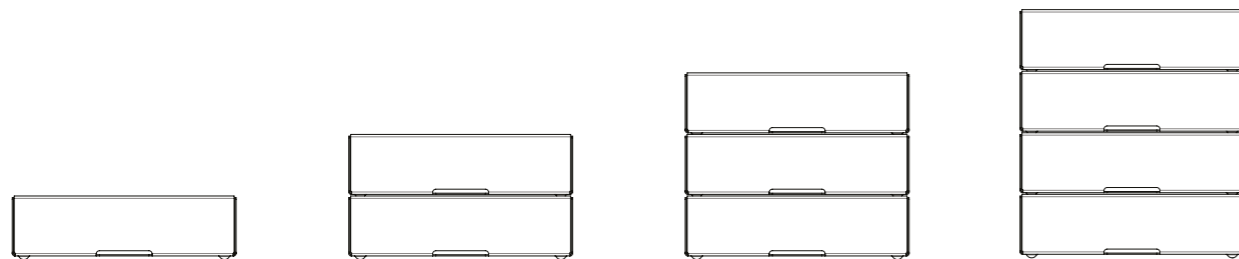



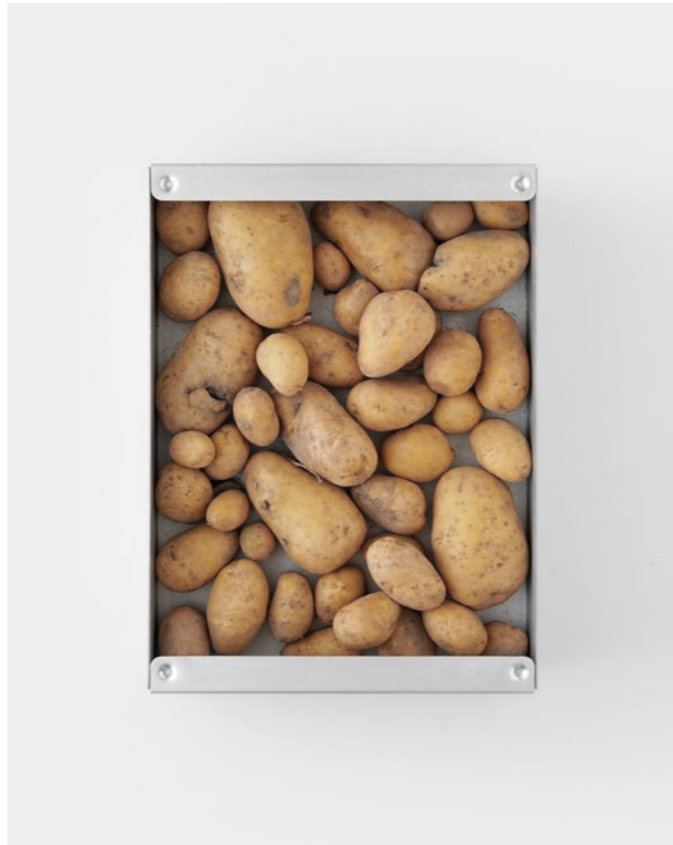
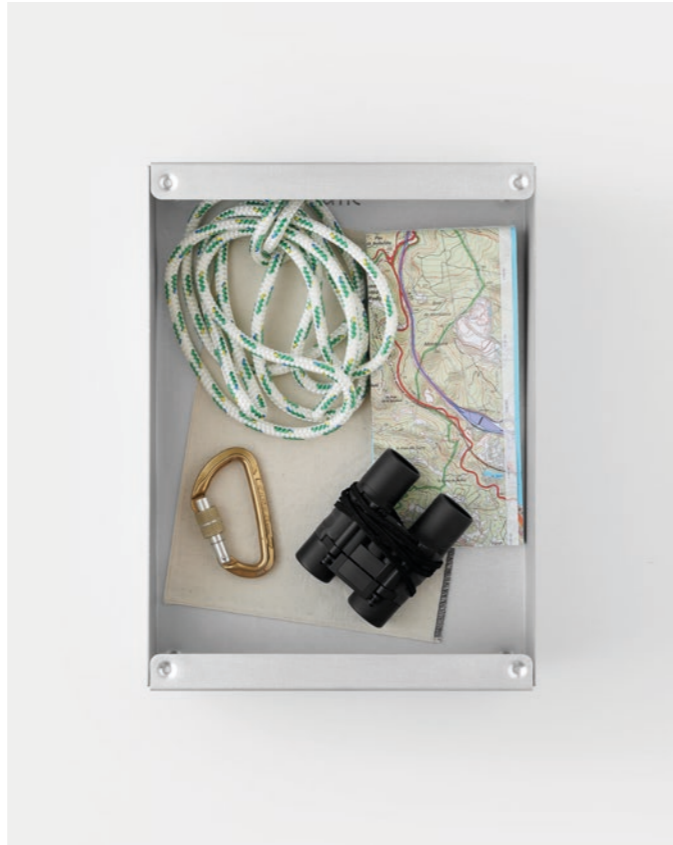

©Studio CP—RV



©Max Verret

KGT WALL UNITS

Designed by CP RV

KGT Wall Unit
One



KGT Wall Unit
Three Vertical

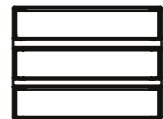

KGT Wall Unit
Six Vertical

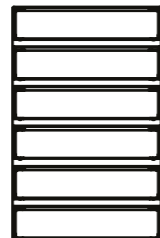

KGT Wall Unit
Three Horizontal









BASSO TROLLEY

Designed by Manuel Amaral Netto







HAL COAT RACK

Designed by Manuel Amaral Netto





DESIGNERS

When designing new furniture and accessories for the modern home UTIL underlines the importance of sticking to the essential. For that, we rely on a group of exceptional emerging designers working together with the know-how of the best manufacturers in Portugal who love and understand their craftsmanship, while nourishing a collaborative relationship in order to develop the most pertinent furniture for the market.



©Deniel Delang

FROM INDUSTRIAL DESIGN is a collaboration between Cesare Bizzotto and Tobias Nitsche founded after having obtained their Master together in Product design from ECAL (CH). As a team, they take advantage of their cultural diversity, at the same time sharing a common vision on design. Their thorough approach to the project has allowed the two young designers to immediately collaborate with some of the most prestigious companies in the sector.



MANUEL AMARAL NETTO graduated from ESAD-Cr in 2006 acquired a Master in Design Products at ECAL (CH) in 2013. Co-founds FROM INDUSTRIAL DESIGN in 2014 He has since then worked for a variety of different brands and institutions such as Cassina (IT), USM (CH), Leucos (IT), Baccarat (FR), AICEP (PT) or Vista Alegre (PT). He is the founder and creative director of UTIL.



CP RV is a collaborative project run by Camille Paillard and Romain Voulet, working between London and Marseille. Formed by designers gathered together from different backgrounds, the practice designs products, home furniture, interior spaces and things to live with.



JEANNE MERCIER is a product designer based in Paris, born in 1998. She graduated from ECAL/University of Art and Design in Switzerland in 2019 with a degree in Product Design, where she developed a keen eye for detail and an interest in shaping materials. After graduation, Jeanne began working as a project assistant for Julie Richoz and Rodolphe Parente. In addition to her work in industrial design, Jeanne has also established herself as an independent designer. Her creative projects span a variety of disciplines, including furniture, textiles and set design, and are characterised by their practicality and versatility. Jeanne's designs focus on meeting the needs of the user, while reflecting her sensitivity and curiosity about craft.

©Pedro Gaspar

Product Specifications

BASSO

Designed by	Manuel Amaral Netto
Material	Powder Coated Steel, cork, casters with PU wheels
Product Dimensions	Ø39 x 52 cm
Packaging Dimensions	43 x 43 x 60 cm 15 Kg
Assembly Needed	No
SKU	1110.010.00

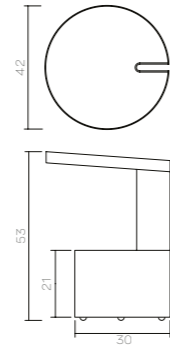

HAL

Designed by	Manuel Amaral Netto
Material	Powder Coated Steel
Product Dimensions	52/82 cm x 17 cm x 18 cm
Packaging Dimensions	55 cm x 20 cm x 20 cm / 5 Kg 85 cm x 20 cm x 20 cm / 7 Kg
Assembly Needed	No
SKU	1310.050.00 1310.080.00

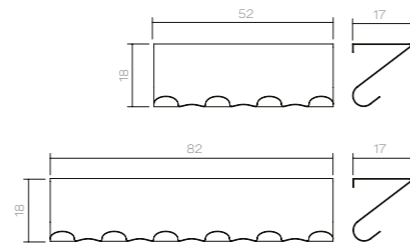

UTIL X JAK SHOE RACK

Designed by	Jeanne Mercier
Material	Powder Coated Aluminium
Product Dimensions	95 cm x 35 cm x 17 cm
Packaging Dimensions	99 cm x 39 cm x 22 cm 5 Kg
Assembly Needed	No
SKU	1600.094.00

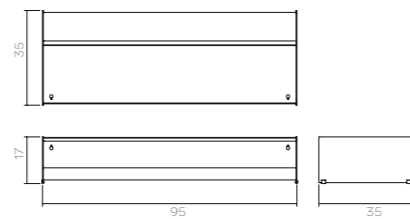

PLIÉ MEDIA UNIT

Designed by	FROM INDUSTRIAL DESIGN
Material	Powder Coated Aluminium
Product Dimensions	90/120 x 35 x 50 cm
Packaging Dimensions	98/128 cm x 51 cm x 18 cm 15 Kg
Assembly Needed	Yes
SKU	1550.090.00 1550.120.00

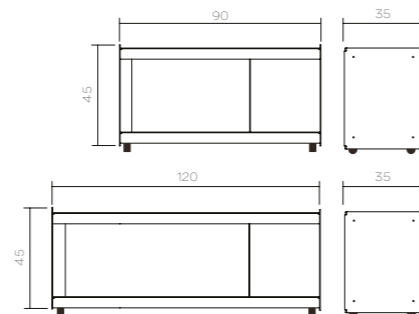

PLIÉ WALL SHELVES 2

Designed by	FROM INDUSTRIAL DESIGN
Material	Powder Coated Aluminium
Product Dimensions	70/90/120 cm x 17 cm x 49 cm
Packaging Dimensions	82 cm x 28 cm x 18 cm / 5 Kg 102 cm x 28 cm x 18 cm / 6 Kg 132 cm x 28 cm x 18 cm / 7 Kg
Assembly Needed	Yes
SKU	1572.070.00 / 1572.090.00 1572.120.00

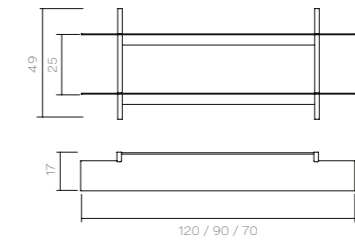

PLIÉ WALL SHELVES 3

Designed by	FROM INDUSTRIAL DESIGN
Material	Powder Coated Aluminium
Product Dimensions	70/90/120 cm x 17 cm x 75 cm
Packaging Dimensions	82 cm x 28 cm x 18 cm / 5 Kg 102 cm x 28 cm x 18 cm / 6 Kg 132 cm x 28 cm x 18 cm / 7 Kg
Assembly Needed	Yes
SKU	1573.070.00 / 1573.090.00 1573.120.00

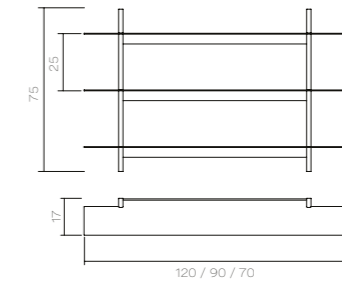

PLIÉ WALL SHELVES 4

Designed by	FROM INDUSTRIAL DESIGN
Material	Powder Coated Aluminium
Product Dimensions	70/90/120 cm x 17 cm x 105 cm
Packaging Dimensions	82 cm x 28 cm x 18 cm - 5 Kg 102 cm x 28 cm x 18 cm - 6 Kg 132 cm x 28 cm x 18 cm - 7 Kg + 125 cm x 20 x 8 cm / 6Kg
Assembly Needed	Yes
SKU	1574.070.00 / 1574.090.00 1574.120.00

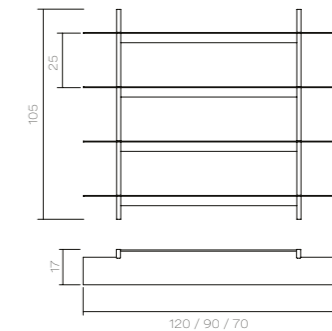

PLIÉ SINGLE SHELF

Designed by	FROM INDUSTRIAL DESIGN
Material	Powder Coated Aluminium
Product Dimensions	70/90/120 cm x 17 cm x 105 cm
Packaging Dimensions	80/125 cm x 16 cm x 8 cm 2 Kg / 3 Kg
Assembly Needed	Yes
SKU	1560.060.00 1560.075.00 1560.120.00

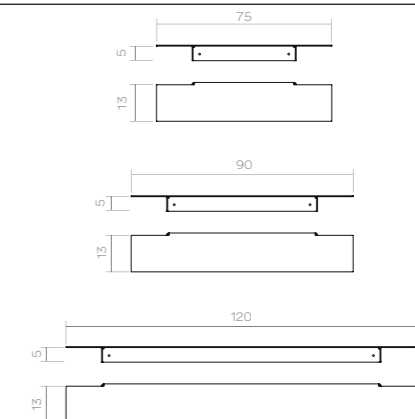

Product Specifications

PLIÉ WALL MOUNT

Designed by FROM INDUSTRIAL DESIGN
 Material Powder Coated Aluminium
 Product Dimensions 90/120 cm x 35 cm x 45 cm
 Packaging Dimensions 98/129 cm x 51 cm x 18 cm
 13 Kg
 Assembly Needed Yes
 SKU 1540.090.00
 1540.120.00

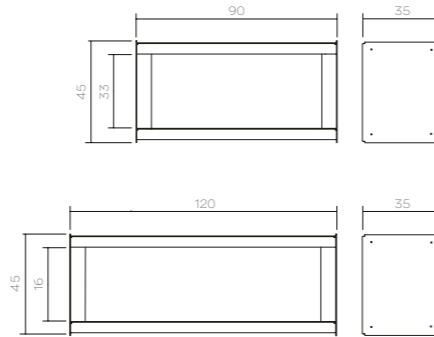

PLIÉ WALL MOUNT DOORS

Designed by FROM INDUSTRIAL DESIGN
 Material Powder Coated Aluminium
 Product Dimensions 90/120 cm x 35 cm x 45 cm
 Packaging Dimensions 98/129 cm x 51 cm x 18 cm
 14Kg
 Assembly Needed Yes
 SKU 1547.090.00
 1547.120.00

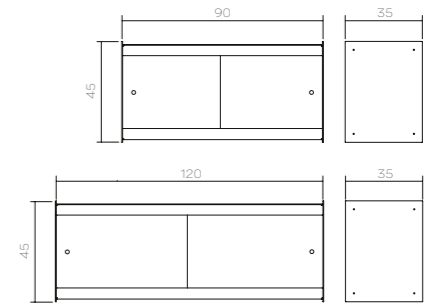

PLIÉ WALL MOUNT EXTENSION

Designed by FROM INDUSTRIAL DESIGN
 Material Powder Coated Aluminium
 Product Dimensions 180/240 cm x 35 cm x 45 cm
 Packaging Dimensions 98/129 cm x 51 cm x 18 cm
 13 Kg / 14 Kg
 2 Volumes
 Assembly Needed Yes
 SKU 1540.180.00
 1540.240.00

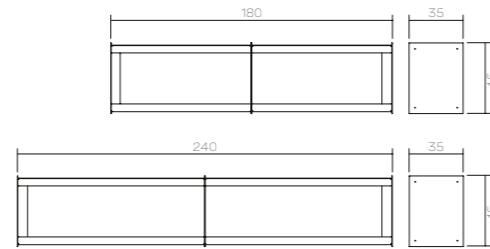

PLIÉ WALL MOUNT DRAWERS

Designed by FROM INDUSTRIAL DESIGN
 Material Powder Coated Aluminium
 Product Dimensions 90/120 cm x 35 cm x 45 cm
 Packaging Dimensions 98/129 cm x 51 cm x 18 cm
 14 Kg
 + 96/126 cm x 41 cm x 39 cm
 15 or 17 Kg
 Assembly Needed Yes

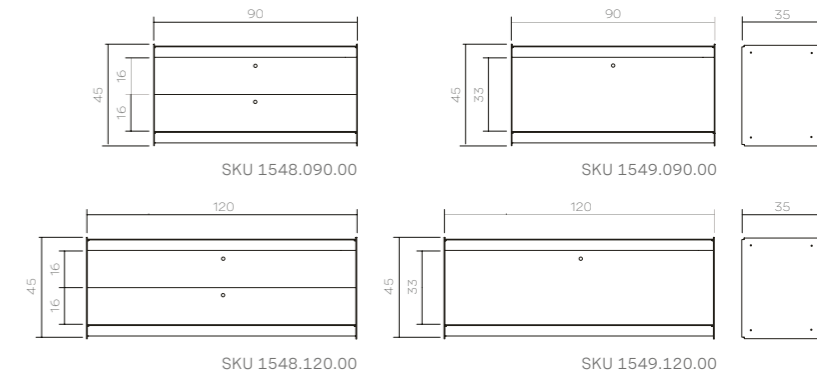

PLIÉ WALL MOUNT EXTENSION DOORS

Designed by FROM INDUSTRIAL DESIGN
 Material Powder Coated Aluminium
 Product Dimensions 180/240 cm x 35 cm x 45 cm
 Packaging Dimensions 98/129 cm x 51 cm x 18 cm
 14 Kg / 16 Kg
 2 Volumes
 Assembly Needed Yes

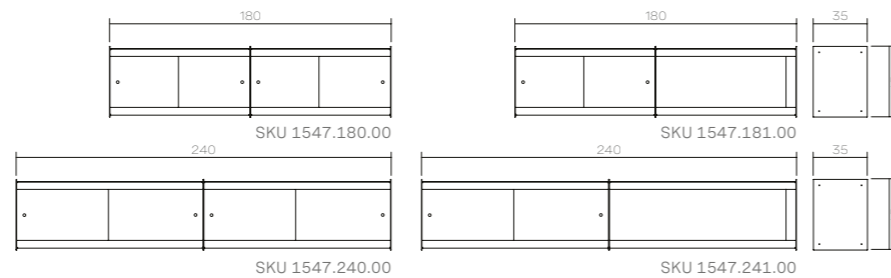

PLIÉ WALL MOUNT EXTENSION DRAWERS

Designed by FROM INDUSTRIAL DESIGN
 Material Powder Coated Aluminium
 Product Dimensions Ø39 x 52 cm
 Packaging Dimensions 98/129 cm x 51 cm x 18 cm
 14 Kg
 + 96/126 cm x 41 cm x 39 cm
 15 or 17 Kg
 3 or 4 Volumes
 Assembly Needed Yes

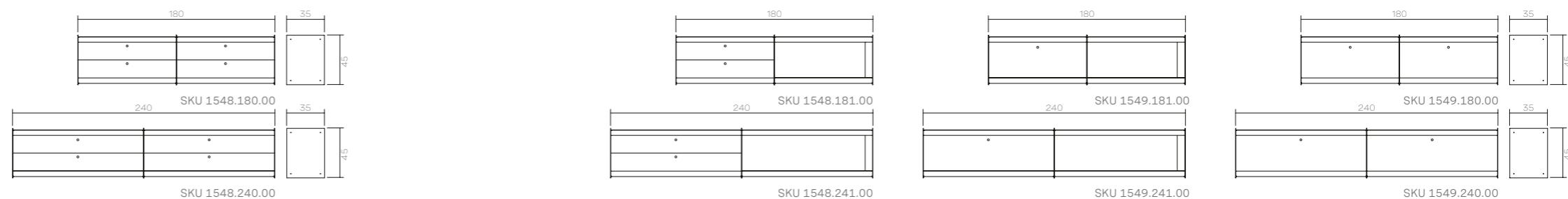

Product Specifications

PLIÉ SIDEBOARD

Designed by FROM INDUSTRIAL DESIGN
 Material Powder Coated Aluminium
 Product Dimensions 90/120 cm x 83 cm x 35 cm
 Packaging Dimensions 98/129 cm x 51 cm x 18 cm
 14 or 16 Kg
 Assembly Needed Yes
 SKU 1520.090.00 / 1520.120.00

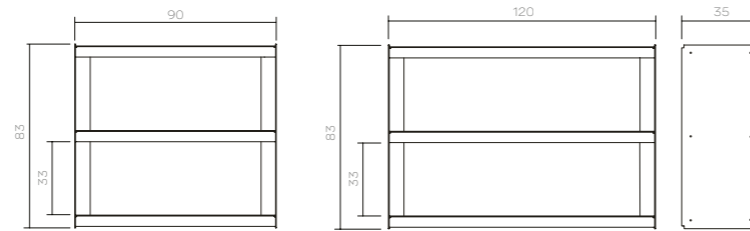

PLIÉ SIDEBOARD DRAWERS

Designed by FROM INDUSTRIAL DESIGN
 Material Powder Coated Aluminium
 Product Dimensions 90/120 cm x 83 cm x 35 cm
 Packaging Dimensions 98/129 cm x 51 cm x 18 cm
 14 or 16 Kg
 + 96/126 cm x 41 cm x 39 cm
 15 or 17 Kg
 2 Volumes
 Assembly Needed Yes
 SKU 1529.090.00 / 1528.090.00 / 1529.120.00 / 1528.120.00

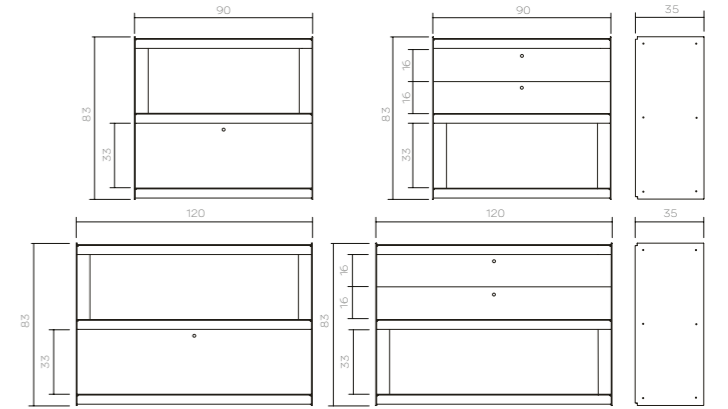

PLIÉ SIDEBOARD DOORS

Designed by FROM INDUSTRIAL DESIGN
 Material Powder Coated Aluminium
 Product Dimensions 90/120 cm x 83 cm x 35 cm
 Packaging Dimensions 98/129 cm x 51 cm x 18 cm
 15 or 17 Kg
 Assembly Needed Yes
 SKU 1527.090.00 / 1527.120.00

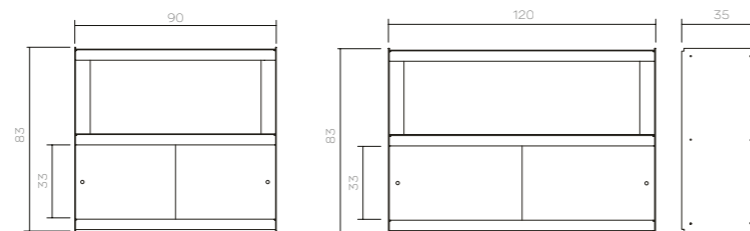

PLIÉ SIDEBOARD DRAWERS 2

Designed by FROM INDUSTRIAL DESIGN
 Material Powder Coated Aluminium
 Product Dimensions 90/120 cm x 83 cm x 35 cm
 Packaging Dimensions 98/129 cm x 51 cm x 18 cm
 14 or 16 Kg
 + 96/126 cm x 41 cm x 39 cm
 15 or 17 Kg
 3 Volumes
 Assembly Needed Yes
 SKU 1524.090.00 / 1525.090.00 / 1524.120.00 / 1525.120.00

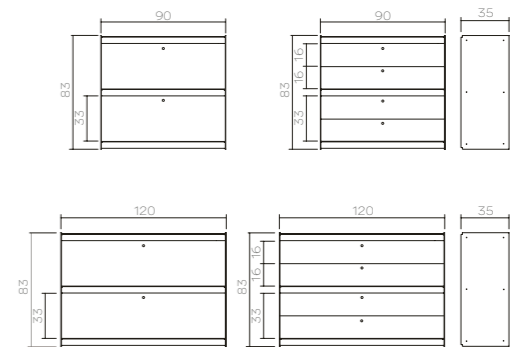

PLIÉ SIDEBOARD EXTENSION

Designed by FROM INDUSTRIAL DESIGN
 Material Powder Coated Aluminium
 Product Dimensions 180/240 cm x 83 cm x 35 cm
 Packaging Dimensions 98/129 cm x 51 cm x 18 cm
 14 or 16 Kg
 2 Volumes
 Assembly Needed Yes
 SKU 1520.180.00 / 1520.240.00

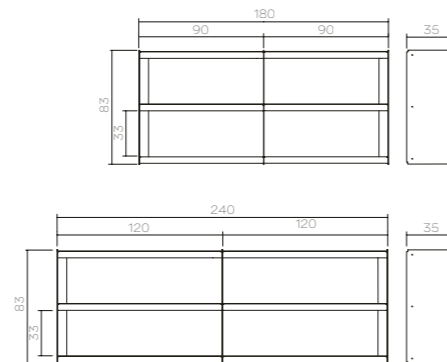

PLIÉ SIDEBOARD EXTENSION DRAWERS

Designed by FROM INDUSTRIAL DESIGN
 Material Powder Coated Aluminium
 Product Dimensions 180/240 cm x 83 cm x 35 cm
 Packaging Dimensions 98/129 cm x 51 cm x 18 cm
 14 or 16 Kg
 + 96/126 cm x 41 cm x 39 cm
 15 or 17 Kg
 4 Volumes
 Assembly Needed Yes

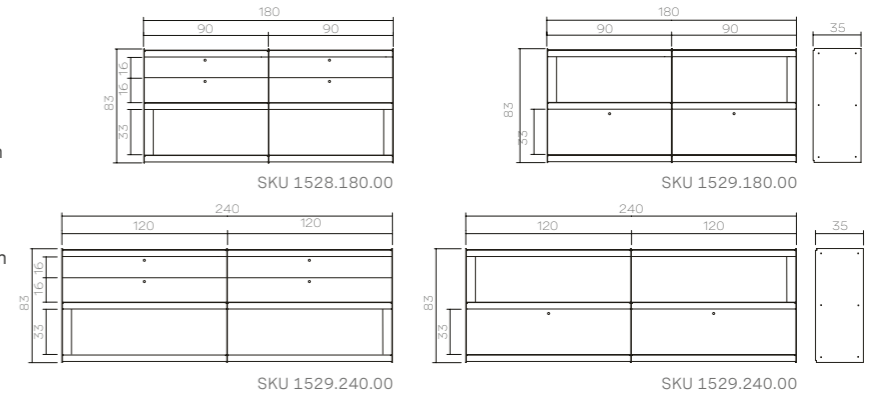

PLIÉ SIDEBOARD EXTENSION DOORS

Designed by FROM INDUSTRIAL DESIGN
 Material Powder Coated Aluminium
 Product Dimensions 180/240 cm x 83 cm x 35 cm
 Packaging Dimensions 98/129 cm x 51 cm x 18 cm
 15 or 17 Kg
 2 Volumes
 Assembly Needed Yes
 SKU 1527.180.00 / 1527.240.00

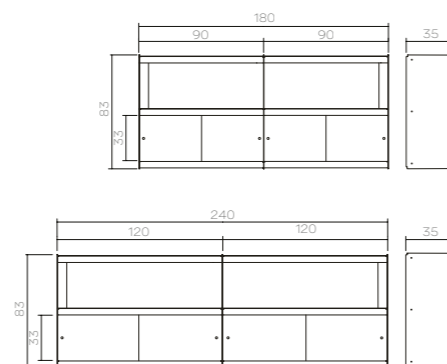

PLIÉ SIDEBOARD EXTENSION DRAWERS 2

Designed by FROM INDUSTRIAL DESIGN
 Material Powder Coated Aluminium
 Product Dimensions 180/240 cm x 83 cm x 35 cm
 Packaging Dimensions 98/129 cm x 51 cm x 18 cm
 14 or 16 Kg
 + 96/126 cm x 41 cm x 39 cm
 15 or 17 Kg
 6 Volumes
 Assembly Needed Yes

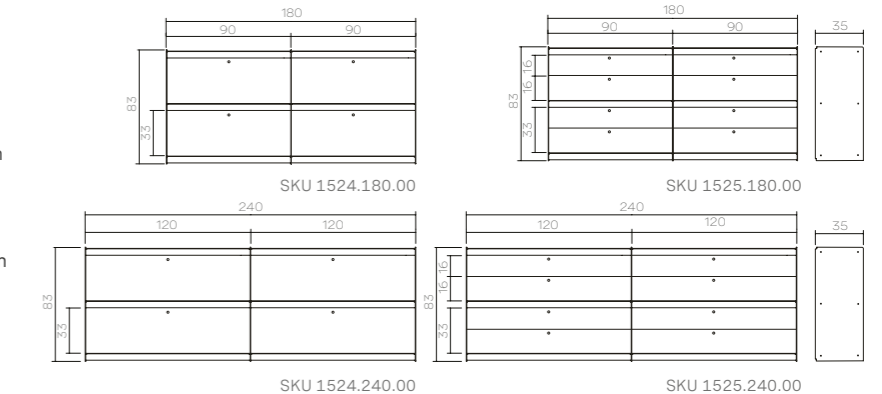

Product Specifications

PLIÉ BOOKSHELF

Designed by FROM INDUSTRIAL DESIGN
 Material Powder Coated Aluminium
 Product Dimensions 90/120 cm x 35 cm x 196 cm
 Packaging Dimensions 2 x (98/128 cm x 51 cm x 18 cm) 2 x 12.5 Kg
 + 1 x (198 cm x 40 cm x 12 cm) 17Kg
 Assembly Needed Yes
 SKU 1530.090.00 / 1530.120.00

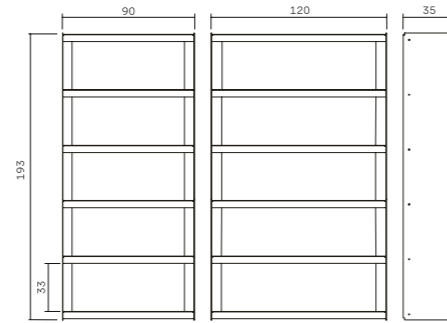

PLIÉ BOOKSHELF DOORS

Designed by FROM INDUSTRIAL DESIGN
 Material Powder Coated Aluminium
 Product Dimensions 90/120 cm x 35 cm x 196 cm
 Packaging Dimensions 2 x (98/128 cm x 51 cm x 18 cm) 2 x 12.5 Kg
 + 1 x (198 cm x 40 cm x 12 cm) 17Kg
 Assembly Needed Yes
 SKU 1537.090.00 / 1537.120.00

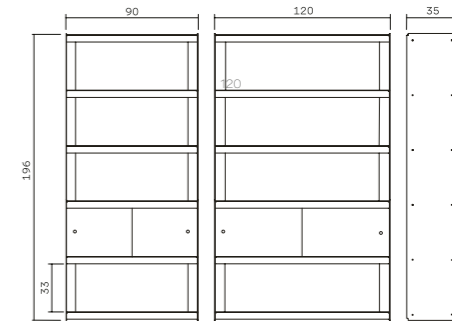

PLIÉ BOOKSHELF EXTENTION

Designed by FROM INDUSTRIAL DESIGN
 Material Powder Coated Aluminium
 Product Dimensions 120/240 cm x 35 cm x 196 cm
 Packaging Dimensions 4 x (98/128 cm x 51 cm x 18 cm) 4 x 12.5 Kg
 + 1 x (198 cm x 40 cm x 12 cm) 20Kg
 Assembly Needed Yes
 SKU 1530.180.00 / 1530.240.00

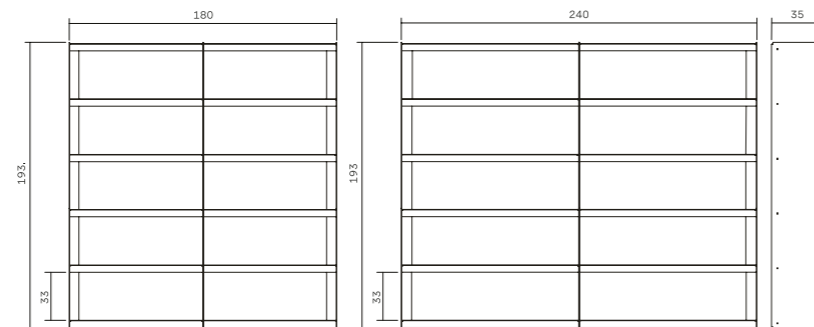

PLIÉ BOOKSHELF DRAWERS

Designed by FROM INDUSTRIAL DESIGN
 Material Powder Coated Aluminium
 Product Dimensions Ø39 x 52 cm
 Packaging Dimensions 43 x 43 x 60 cm / 15 Kg
 Assembly Needed Yes

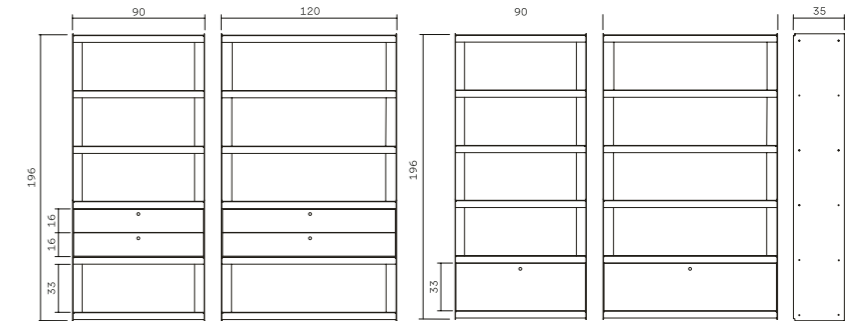

PLIÉ BOOKSHELF EXTENSION DOORS

Designed by FROM INDUSTRIAL DESIGN
 Material Powder Coated Aluminium
 Product Dimensions 120/240 cm x 35 cm x 196 cm
 Packaging Dimensions 4 x (98/128 cm x 51 cm x 18 cm) 4 x 12.5 Kg
 + 1 x (198 cm x 40 cm x 12 cm) 20Kg
 Assembly Needed Yes
 SKU 1537.180.00 / 1537.240.00

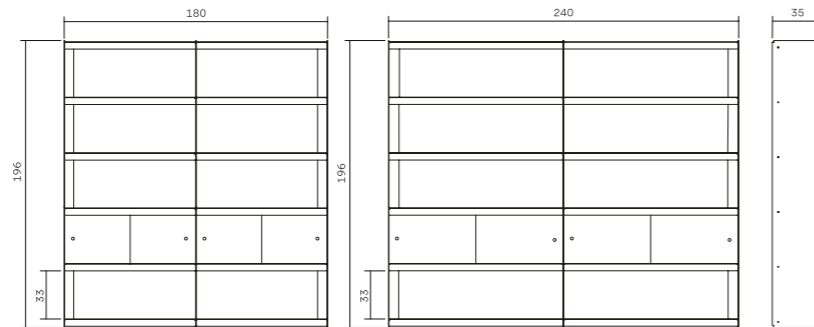

PLIÉ SIDE TABLE

Designed by FROM INDUSTRIAL DESIGN
 Material Powder Coated Aluminium
 Product Dimensions 45 cm x 35 cm x 45 cm
 Packaging Dimensions 56 cm x 51 cm x 20 cm
 7 Kg
 Assembly Needed Yes
 SKU 1510.045.00

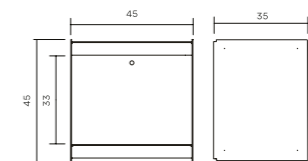

PLIÉ BOOKSHELF EXTENSION DRAWERS

Designed by FROM INDUSTRIAL DESIGN
 Material Powder Coated Aluminium
 Product Dimensions Ø39 x 52 cm
 Packaging Dimensions 4 x (98/128 cm x 51 cm x 18 cm) 4 x 12.5 Kg
 + 1 x (198 cm x 40 cm x 12 cm) 20Kg
 + 96/126 cm x 41 cm x 39 cm
 Assembly Needed Yes

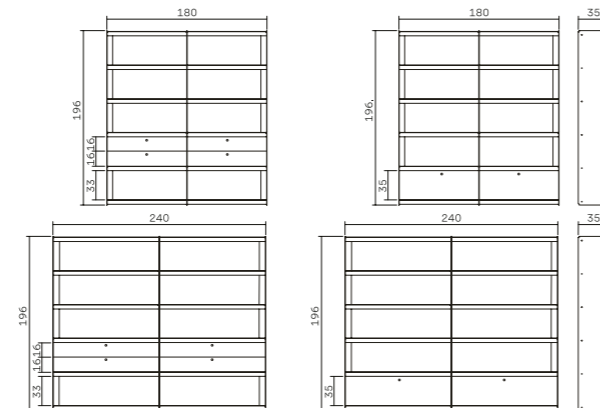

PLIÉ SIDE TABLE DRAWERS

Designed by FROM INDUSTRIAL DESIGN
 Material Powder Coated Aluminium
 Product Dimensions 45 cm x 35 cm x 45 cm
 Packaging Dimensions 56 cm x 51 cm x 20 cm
 + 51 cm x 41 cm x 39 cm
 10 Kg
 Assembly Needed Yes
 SKU 1519.045.00 / 1518.045.00

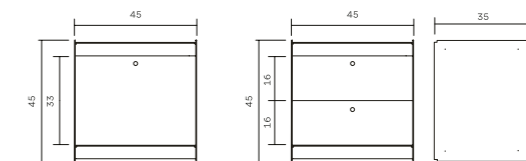

Product Specifications

PLIÉ FLOOR UNIT

Designed by FROM INDUSTRIAL DESIGN
 Material Powder Coated Aluminium
 Product Dimensions 90/120 cm x 35 cm x 45 cm
 Packaging Dimensions 98/129 cm x 51 cm x 18 cm
 13 Kg
 Assembly Needed Yes
 SKU 1510.090.00
 1510.120.00

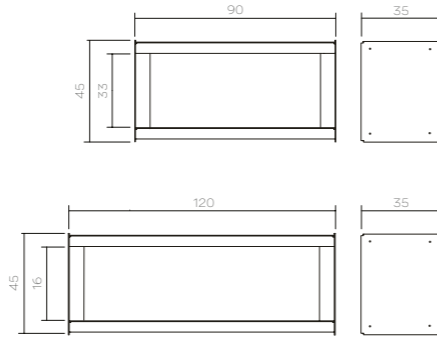

KGT WALL UNIT SINGLE

Designed by CP RV
 Material Powder Coated Aluminium
 Product Dimensions 39 cm x 29.5 cm x 9 cm
 Packaging Dimensions -
 Assembly Needed Yes
 SKU 1601.001.00

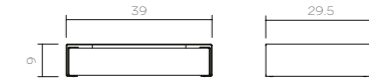

PLIÉ FLOOR UNIT DRAWER

Designed by FROM INDUSTRIAL DESIGN
 Material Powder Coated Aluminium
 Product Dimensions 90/120 cm x 35 cm x 45 cm
 Packaging Dimensions 43 x 43 x 60 cm / 15 Kg
 Assembly Needed Yes
 SKU 1110.010.00

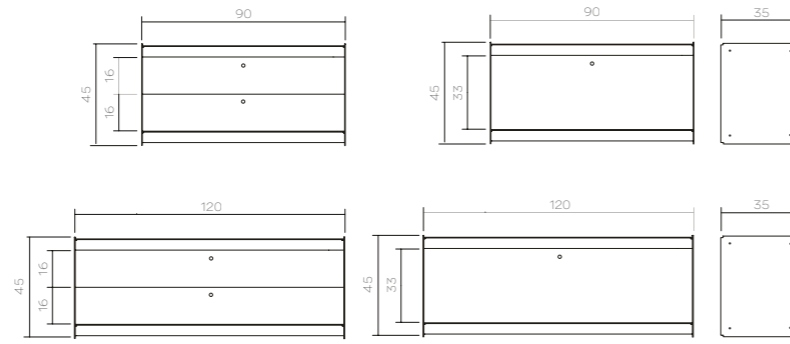

KGT WALL UNIT 3 VERTICAL

Designed by CP RV
 Material Powder Coated Aluminium
 Product Dimensions 39 cm x 29.5 cm x 29.5 cm
 Packaging Dimensions -
 Assembly Needed Yes
 SKU 1601.003.00

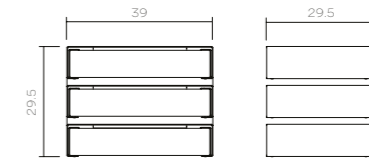

PLIÉ FLOOR UNIT DOORS

Designed by FROM INDUSTRIAL DESIGN
 Material Powder Coated Aluminium
 Product Dimensions Ø39 x 52 cm
 Packaging Dimensions 43 x 43 x 60 cm / 15 Kg
 Assembly Needed Yes
 SKU 1110.010.00

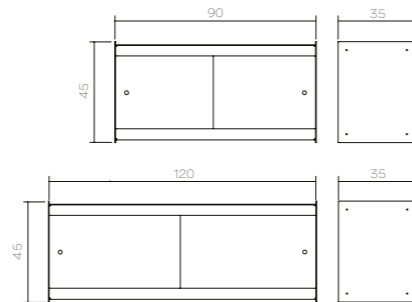

KGT WALL UNIT 3 HORIZONTAL

Designed by CP RV
 Material Powder Coated Aluminium
 Product Dimensions 116 cm x 29.5 cm x 9 cm
 Packaging Dimensions -
 Assembly Needed Yes
 SKU 1601.013.00

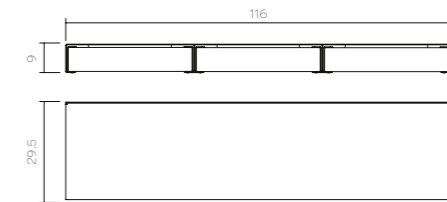

KGT

Designed by CP RV
 Material Powder Coated Aluminium
 Product Dimensions 38 cm x 28 cm x 8 cm
 Packaging Dimensions 30 cm x 40 cm x 10 cm
 2 Kg
 Assembly Needed Yes
 SKU 1600.001.00

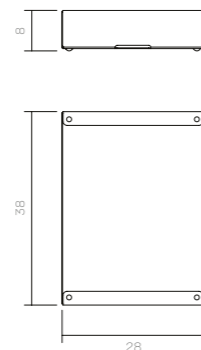





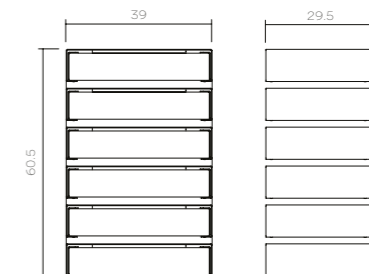









KGT WALL UNIT 6 VERTICAL

Designed by CP RV
 Material Powder Coated Aluminium
 Product Dimensions 39 cm x 29.5 cm x 60.5 cm
 Packaging Dimensions -
 Assembly Needed Yes
 SKU 1601.006.00



Colors and Finishes

	Jet Black with fine texture RAL 9005
	Light Grey with fine texture RAL 7047
	Beige with fine texture RAL 1019
	Midnight Blue with fine texture RAL 1018
	Bright Red with fine texture RAL 3020
	Coral with fine texture RAL 3012
	Ultramarine Blue with fine texture RAL 5017
	Ivory with fine texture RAL 1015
	Yellow with fine texture RAL 1018
	Mint with fine texture RAL 6019
	Zinc Plated
	Brushed Aluminium
	Vermilion with fine texture RAL 1010
	Pure Green with fine texture RAL 6037
	Dark Red with fine texture RAL 6037

For professional clients, we can work with other colour tones within the RAL K7 Chart or any special finishes from powder coating suppliers such as Axalta.



IMPRINT

This is Util Lda
Rua do Giestal nº37 A/B
1300-275 Lisboa, Portugal
VAT: PT 515 765 333

Pictures
Pedro Alfacinha, Manuel Amaral Netto,
CP RV, Max Verret and Simon Bevan.

Texts
Pedro Mosca and Tomás Carvalhas

Typefaces used
Spezia by Luzi Gantenbein

For more information visit
www.instagram.com/this_is_util
www.thisisutil.com
email at shop@thisisutil.com

Rua do Giestal 37B, 1300-275 Lisboa, Portugal

