

Ovalformer™ Technical Data

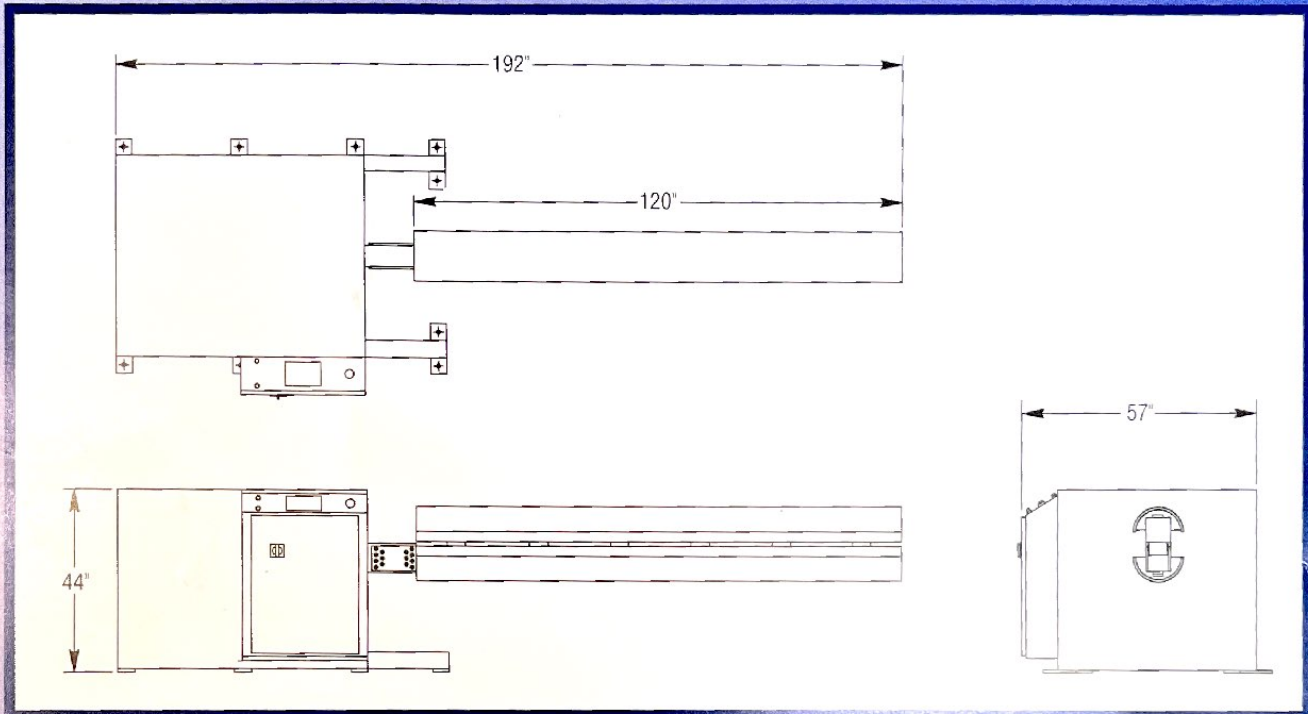

Maximum Sheet Thickness	18 gauge
Maximum Duct Length	20 feet
Voltage	208/230/460v, 3ph
Available Heads	6, 8, 10, 12, 14, 16, 18, 20, 24, 30-inch diameter

For More Information Contact:

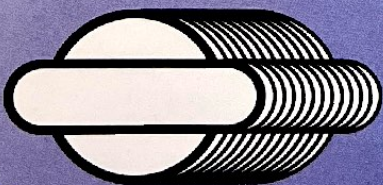

OVALFORMER™

45 Loop Road • Arden, North Carolina 28704

A Division of Price & Price Mechanical, Inc.

1-800-240-0990

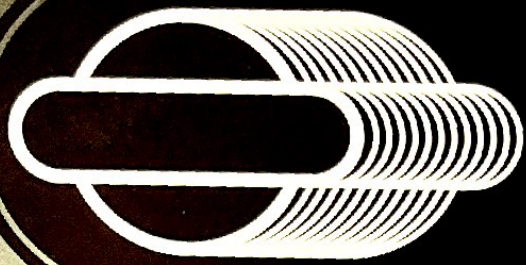

OVALFORMER™

The Ovalformer is a patent pending solution to creating oval shaped ductwork for the HVAC industry. This high quality, high efficiency duct system was previously cost prohibitive to manufacture because of the high cost of manufacturing methods. Ovalformer is a revolutionary new machine that will allow oval duct manufacturers to become more efficient and ultimately more profitable in their manufacturing process.

The Ovalformer's simple design and user friendly controls guarantees that precision flat-oval duct can be manufactured every time. This guarantee is backed by the strongest warranty in the industry. A generous offering of standard head sizes and a large selection of additional head sizes will enable the Ovalformer to be customized for practically every application.

The Ovalformer. High quality oval duct at nearly half the cost!

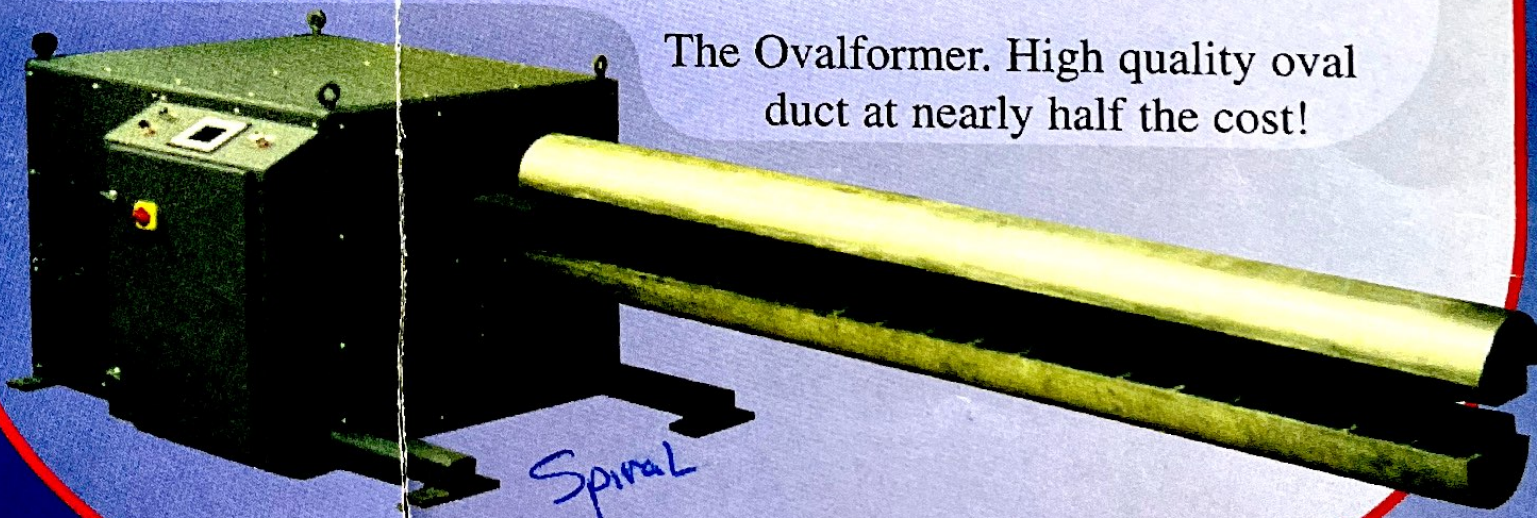

Ovalformer 1018
Oval Size & Gauge* Chart

Stock Diameter	6	8	10	12	14	16	18	20	22	24	26	28	30	32	34	36	38	40	42	44	46	48	
15	20.2																						
16	21.8																						
17	23.4	22.2	21.1	19.9																			
18	25.0	23.8	22.7	21.5	20.3																		
19	26.6	25.4	24.2	23.1	21.9	20.7																	
20	28.1	27.0	25.8	24.7	23.5	22.3	21.2																
22	31.3	30.1	29.0	27.8	26.7	25.5	24.3	23.2															
24	34.5	33.3	32.1	31.0	29.8	28.7	27.5	26.3	25.2														
26	37.6	36.5	35.3	34.1	33.0	31.8	30.7	29.5	28.3	27.2													
28	40.8	39.6	38.5	37.3	36.1	35.0	33.8	32.7	31.5	30.3	29.2												
30	44.0	42.8	41.6	40.5	39.3	38.1	37.0	35.8	34.7	33.5	32.3	31.2											
32	47.1	46.0	44.8	43.6	42.5	41.3	40.1	39.0	37.8	36.7	35.5	34.3	33.2										
34	50.3	49.1	48.0	46.8	45.6	44.5	43.3	42.1	41.0	39.8	38.7	37.5	36.3	35.2									
36	53.5	52.3	51.1	50.0	48.8	47.6	46.5	45.3	44.1	43.0	41.8	40.7	39.5	38.3	37.2								
38	56.6	55.5	54.3	53.1	52.0	50.8	49.6	48.5	47.3	46.1	45.0	43.8	42.7	41.5	40.3	39.2							
40	59.8	58.6	57.5	56.3	55.1	54.0	52.8	51.6	50.5	49.3	48.1	47.0	45.8	44.7	43.5	42.3	41.2						
42	62.9	61.8	60.6	59.5	58.3	57.1	56.0	54.8	53.6	52.5	51.3	50.1	49.0	47.8	46.7	45.5	44.3	43.2					
44	66.1	64.9	63.8	62.6	61.5	60.3	59.1	58.0	56.8	55.6	54.5	53.3	52.1	51.0	49.8	48.7	47.5	46.3	45.2				
46	69.3	68.1	66.9	65.8	64.6	63.5	62.3	61.1	60.0	58.8	57.6	56.5	55.3	54.1	53.0	51.8	50.7	49.5	48.3	47.2			
48	72.4	71.3	70.1	68.9	67.8	66.6	65.5	64.3	63.1	62.0	60.8	59.6	58.5	57.3	56.1	55.0	53.8	52.7	51.5	50.3	49.2		
50	75.6	74.4	73.3	72.1	70.9	69.8	68.6	67.5	66.3	65.1	64.0	62.8	61.6	60.5	59.3	58.1	57.0	55.8	54.7	53.5	52.3	51.2	
52	78.8	77.6	76.4	75.3	74.1	72.9	71.8	70.6	69.5	68.3	67.1	66.0	64.8	63.6	62.5	61.3	60.1	59.0	57.8	56.7	55.5	54.3	
54	81.9	80.8	79.6	78.4	77.3	76.1	74.9	73.8	72.6	71.5	70.3	69.1	68.0	66.8	65.6	64.5	63.3	62.1	61.0	59.8	58.7	57.5	
56			82.8	81.6	80.4	79.3	78.1	76.9	75.8	74.6	73.5	72.3	71.1	70.0	68.8	67.6	66.5	65.3	64.1	63.0	61.8	60.7	
58						82.4	81.3	80.1	78.9	77.8	76.6	75.5	74.3	73.1	72.0	70.8	69.6	68.5	67.3	66.1	65.0	63.8	
60						84.4	83.3	82.1	80.9	79.8	78.6	77.5	76.3	75.1	74.0	72.8	71.6	70.5	69.3	68.1	67.0		
62						86.4	85.3	84.1	82.9	81.8	80.6	79.5	78.3	77.1	76.0	74.8	73.6	72.5	71.3	70.1			
64										86.1	84.9	83.8	82.6	81.5	80.3	79.1	78.0	76.8	75.6	74.5	73.3		
66																							
68																							
70																							
72																							
74																							
76																							
78																							
80																							

* Gauges as per SMACNA "HVAC Duct Construction Standards", 1985

Ovalformer™

AFFILIATE OF PRICE & PRICE MECHANICAL
 45 Loop Road
 PO Box 793
 Arden, NC 28704
 Phone: (828) 687-9990
 Fax: (828) 687-9938

Capacity of Ovalformer™ 1018

Minor Axis	6	8	10	12	14	16	18	20	22	24
Stock Diameter	Major Axis									
15	20.2									
16	21.8									
17	23.4	22.2	21.1	19.9						
18	25.0	23.8	22.7	21.5	20.3					
19	26.6	25.4	24.2	23.1	21.9	20.7				
20	28.1	27.0	25.8	24.7	23.5	22.3	21.2			
22	31.3	30.1	29.0	27.8	26.7	25.5	24.3	23.2		
24	34.5	33.3	32.1	31.0	29.8	28.7	27.5	26.3	25.2	
26	37.6	36.5	35.3	34.1	33.0	31.8	30.7	29.5	28.3	27.2
28	40.8	39.6	38.5	37.3	36.1	35.0	33.8	32.7	31.5	30.3
30	44.0	42.8	41.6	40.5	39.3	38.1	37.0	35.8	34.7	33.5
32	47.1	46.0	44.8	43.6	42.5	41.3	40.1	39.0	37.8	36.7
34	50.3	49.1	48.0	46.8	45.6	44.5	43.3	42.1	41.0	39.8
36	53.5	52.3	51.1	50.0	48.8	47.6	46.5	45.3	44.1	43.0
38	56.6	55.5	54.3	53.1	52.0	50.8	49.6	48.5	47.3	46.1
40	59.8	58.6	57.5	56.3	55.1	54.0	52.8	51.6	50.5	49.3
42	62.9	61.8	60.6	59.5	58.3	57.1	56.0	54.8	53.6	52.5
44	66.1	64.9	63.8	62.6	61.5	60.3	59.1	58.0	56.8	55.6
46	69.3	68.1	66.9	65.8	64.6	63.5	62.3	61.1	60.0	58.8
48	72.4	71.3	70.1	68.9	67.8	66.6	65.5	64.3	63.1	62.0
50	75.6	74.4	73.3	72.1	70.9	69.8	68.6	67.5	66.3	65.1
52	78.8	77.6	76.4	75.3	74.1	72.9	71.8	70.6	69.5	68.3
54	81.9	80.8	79.6	78.4	77.3	76.1	74.9	73.8	72.6	71.5
56			82.8	81.6	80.4	79.3	78.1	76.9	75.8	74.6
58						82.4	81.3	80.1	78.9	77.8
60								83.3	82.1	80.9

** Heads for minor diameters 8, 10, 12, 14, 16, & 18 are included with base package



OVALFORMER™

Changing The Shape
Of The Future
1-800-729-1069

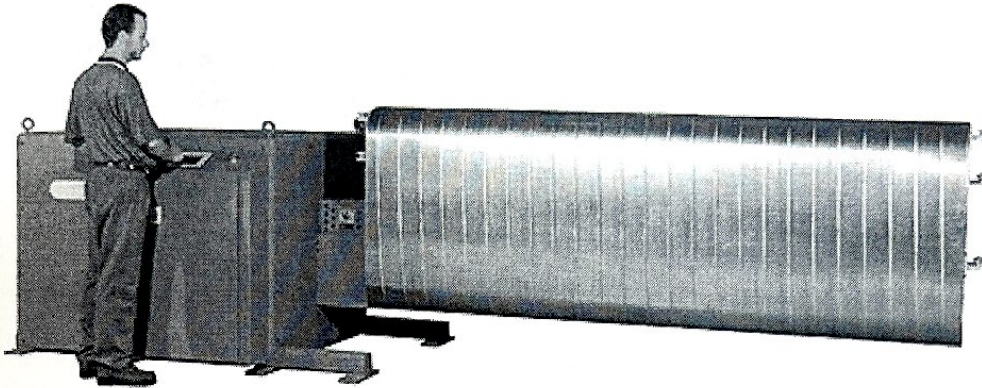

Ovalformer OR1018 Technical Characteristics



Min. Pipe Diameter
15 in. (380 mm)

Material Capacity
Up to 18 gauge

Max. Pipe Diameter
60 in. (1,525 mm)

Electrical
220/60Hz/3 Ph.

Materials
Aluminum, steel, and stainless steel

Machine Weight
5,000+ lbs. (2,275 kg)

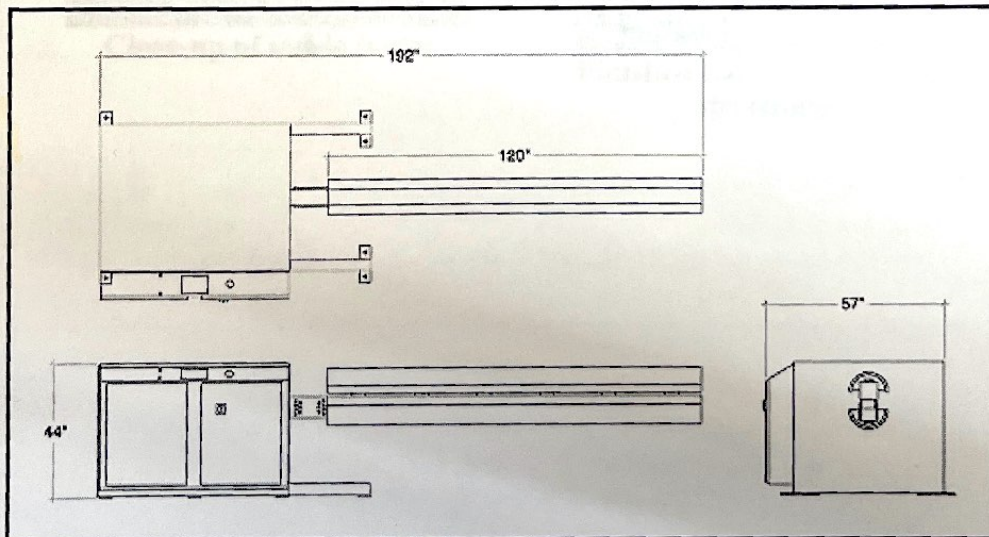

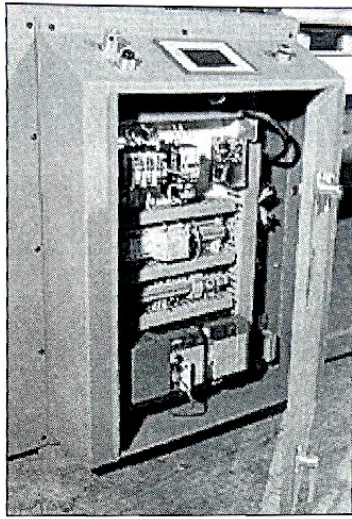

Inside front panel

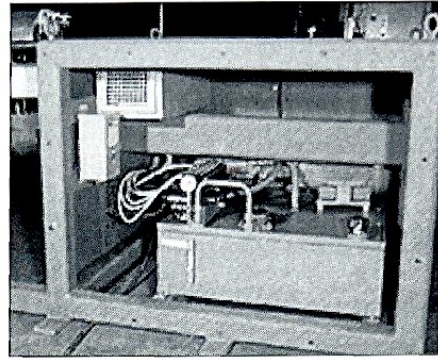

Inside back panel

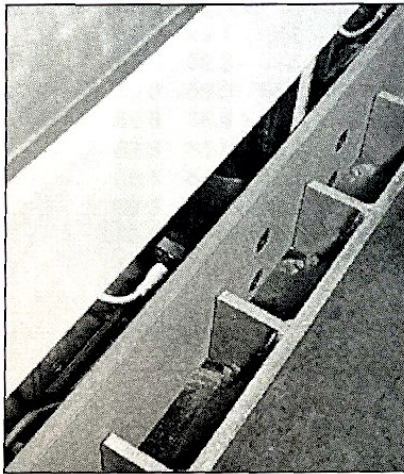

Close-up of inside boom

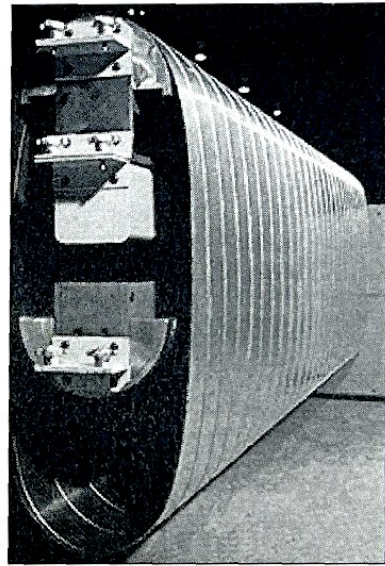

Finished flat oval duct after stretching

[Return to Ovalformer](#)

- [Home](#) | [Company Info](#) | [Product Line](#) | [Future Products](#)
- [Ovalformer](#) | [Spiralformer](#) | [Spiralflex](#) | [Tybeformer](#) | [Gorelock](#) | [Oval](#)
- [Flangeformer](#) | [Seamwelder](#) | [Outside Diameter Support](#)

OVALFORMER LLC, Affiliate of Price & Price Mechanical
 45 Loop Road, P.O. Box 793, Arden, NC 28704
 1-800-729-1069 or 928-681-0802

©1999-2002 All Rights Reserved
 Web site designed by The Livestock People

Ovalformer 1018 Oval Size & Gauge* Chart

Minor Axis Stock Diameter	6	8	10	12	14	16	18	20	22	24	
	Major Axis										
15	20.2										
16	21.8										
17	23.4	22.2	21.1	19.9							
18	25.0	23.8	22.7	21.5	20.3						24 gauge
19	26.6	25.4	24.2	23.1	21.9	20.7					
20	28.1	27.0	25.8	24.7	23.5	22.3	21.2				
22	31.3	30.1	29.0	27.8	26.7	25.5	24.3	23.2			
24	34.5	33.3	32.1	31.0	29.8	28.7	27.5	26.3	25.2		
26	37.6	36.5	35.3	34.1	33.0	31.8	30.7	29.5	28.3	27.2	
28	40.8	39.6	38.5	37.3	36.1	35.0	33.8	32.7	31.5	30.3	
30	44.0	42.8	41.6	40.5	39.3	38.1	37.0	35.8	34.7	33.5	
32	47.1	46.0	44.8	43.6	42.5	41.3	40.1	39.0	37.8	36.7	22 gauge
34	50.3	49.1	48.0	46.8	45.6	44.5	43.3	42.1	41.0	39.8	
36	53.5	52.3	51.1	50.0	48.8	47.6	46.5	45.3	44.1	43.0	
38	56.6	55.5	54.3	53.1	52.0	50.8	49.6	48.5	47.3	46.1	
40	59.8	58.6	57.5	56.3	55.1	54.0	52.8	51.6	50.5	49.3	
42	62.9	61.8	60.6	59.5	58.3	57.1	56.0	54.8	53.6	52.5	
44	66.1	64.9	63.8	62.6	61.5	60.3	59.1	58.0	56.8	55.6	
46	69.3	68.1	66.9	65.8	64.6	63.5	62.3	61.1	60.0	58.8	20 gauge
48	72.4	71.3	70.1	68.9	67.8	66.6	65.5	64.3	63.1	62.0	
50	75.6	74.4	73.3	72.1	70.9	69.8	68.6	67.5	66.3	65.1	
52	78.8	77.6	76.4	75.3	74.1	72.9	71.8	70.6	69.5	68.3	
54	81.9	80.8	79.6	78.4	77.3	76.1	74.9	73.8	72.6	71.5	
56			82.8	81.6	80.4	79.3	78.1	76.9	75.8	74.6	18 gauge
58						82.4	81.3	80.1	78.9	77.8	
60								83.3	82.1	80.9	

* Gauges as per SMACNA "HVAC Duct Construction Standards". 1985

Return to Ovalformer 1018

[Home](#) | [Company Info](#) | [Product Line](#) | [Future Products](#) | [Contact Us](#) |
[Ovalformer](#) | [Spiralformer](#) | [Spiroflex Tubeformer](#) | [Gorelocker](#) | [Ovalroller](#) |
[Flangeformer](#) | [Seamwelder](#) | [Outside Diameter Support](#) |

OVALFORMER LLC, Affiliate of Price & Price Mechanical
 45 Loop Road, P.O. Box 793, Arden, NC 28704
 1-800-729-1069 or 828-681-0802

©1999-2002 All Rights Reserved.
 Web site designed by The Creative Factory