

MODELS

Natural Gas	Description	Propane
FPB-G16RBSMT-N	16" G90 Black Pan & Spur Kit	FPB-G16RBSMT-P
FPB-G25RBSMT-N	25" G90 Black Pan & Spur Kit	FPB-G25RBSMT-P
FPB-G29RBSMT-N	29" G90 Black Pan & Spur Kit	FPB-G29RBSMT-P
FPB-G33RBSMT-N	33" G90 Black Pan & Spur Kit	FPB-G33RBSMT-P
FPB-19RBSMT-N	19" Round Stainless Pan & Spur Kit	FPB-19RBSMT-P
FPB-25RBSMT-N	25" Round Stainless Pan & Spur Kit	FPB-25RBSMT-P
FPB-20SBSMT-N	20" Square Stainless Pan & Spur Kit	FPB-20SBSMT-P
FPB-26SBSMT-N	26" Square Stainless Pan & Spur Kit	FPB-26SBSMT-P
FPB-32SBSMT-N	32" Square Stainless Pan & Spur Kit	FPB-32SBSMT-P
FPB-38SBSMT-N	38" Square Stainless Pan & Spur Kit	FPB-38SBSMT-P

Outdoor Match Throw Fire Pits

Installation and Operating Instructions

**IF YOU CANNOT READ OR UNDERSTAND THESE INSTALLATION INSTRUCTIONS
DO NOT ATTEMPT TO INSTALL OR OPERATE THIS APPLIANCE**

INSTALLATION PRECAUTION:

This fire pit requires a minimum 18-square inches (per side) of cross ventilation.
Failure to provide proper ventilation can void the warranty.



Warning: For Outdoor Use Only



We recommend that our gas hearth products be installed and serviced by professionals who are certified in the U.S. by the National Fireplace Institute® (NFI) as NFI Gas Specialists.

PLEASE RETAIN THIS MANUAL FOR FUTURE REFERENCE



DANGER



CARBON MONOXIDE HAZZARD

This appliance can produce carbon monoxide which has no odor.

Using it in an enclosed space can kill you.

Never use this appliance in an enclosed space such as a camper, tent, car or home.



DANGER

If you smell gas:

1. Shut off gas to the appliance.
2. Extinguish any open flame.
3. If odor continues, keep away from the appliance and immediately call your gas supplier or fire department.



WARNING

Do not store or use gasoline or other flammable vapors and liquids in the vicinity of this or other appliance.

An LP-cylinder not connected for use shall not be stored in the vicinity of this or any other appliance.

WARNING

Do not leave unattended during use.
Do not use for cooking.
Follow all gas leak procedures in this manual prior to operation.



WARNING

Improper installation, adjustment, alteration, service or maintenance can cause injury or property damage. Read the installation, operating and maintenance instructions thoroughly before installing or servicing this equipment

WARNING: If the information in these instructions is not followed exactly, a fire or explosion may result causing property damage, personal injury or death.

FOR YOUR SAFETY

Do no store or use gasoline or other flammable vapors and liquids in the vicinity of this or another appliance.



Fuels used in gas fired appliances, and the products of combustion such as fuels, contain chemicals known to cause cancer, birth defects and/or other reproductive harm. This warning is issued pursuant to the California Health & Safety Code Sec. 25249.1

TABLE OF CONTENTS

Specifications	3
Preparation for Non-Combustible Structure	4
Hard Piping to Fire Pit	4
Cross Ventilation Requirements	4
High Elevation	4
Installation into an Approved Enclosure	5
Requirements	5
Installing Key Valve	5
Typical Installation Drawings	6
Operation	7
Lighting Instructions	7
Replacement Parts	8
Replacement Parts List	9
Fire Pit Maintenance/ Trouble Shooting	10
Optional Accessories	10

SPECIFICATIONS

Model: Natural Gas (NG)	Model: Propane Gas (LP)	A Pan Depth	B Min./Max. Install Opening	C Inside Pan	D Ground Level	E Side Wall	F Combustible Ceiling	G Combustible Floor
FPB-G16RBSMT-N	FPB-G16RBSMT-P	2.500"	16.5"/17.25"	15.875"	8"	14"	57"	15.5"
FPB-G25RBSMT-N	FPB-G25RBSMT-P	2.500"	25"/25.5"	23.875"	8"	16"	69"	18"
FPB-G29RBSMT-N	FPB-G29RBSMT-P	2.500"	30"/31.35"	29"	8"	16"	69"	18"
FPB-G33RBSMT-N	FPB-G33RBSMT-P	2.500"	34"/35.25"	33"	8"	16"	69"	18"
FPB-19RBSMT-N	FPB-19RBSMT-P	2.625"	19.25/21.5"	19"	8"	16"	69"	18"
FPB-25RBSMT-N	FPB-25RBSMT-P	2.625"	25.25"/27.5"	25"	8"	16"	69"	18"
FPB-20SBSMT-N	FPB-20SBSMT-P	2.625"	20.25"/21.75"	20"	8"	16"	69"	18"
FPB-26SBSMT-N	FPB-26SBSMT-P	2.625"	26.25"/27.75"	26"	8"	16"	69"	18"
FPB-32SBSMT-N	FPB-32SBSMT-P	2.625"	32.25"/33.75"	32"	8"	16"	69"	18"
FPB-38SBSMT-N	FPB-38SBSMT-P	2.625"	38.25"/39.75"	38"	8"	16"	69"	18"

Table 1. Fire pit Dimensions

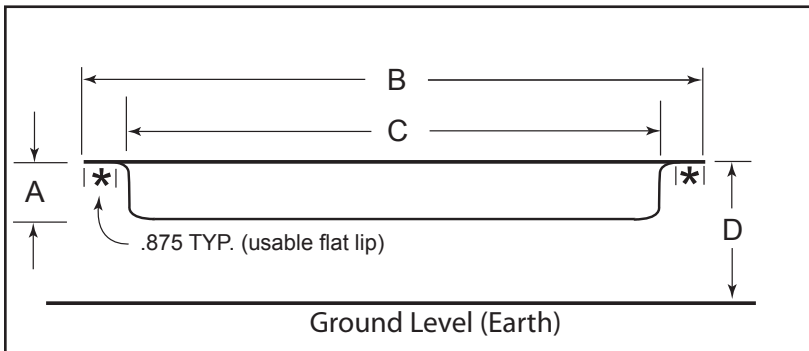

Figure 1. Fire pit dimensions; refer to Table 1.
(Dimensions applicable to round or square pans)

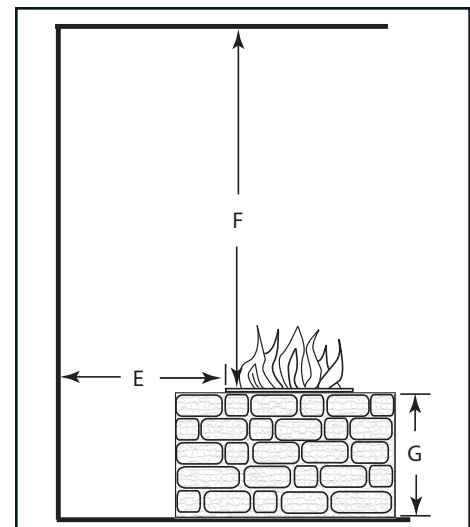

Figure 2. Clearance to Combustibles
(Not to be used in an enclosed space)

Model: Match Throw NG	NG Factory Orifice	Model: Match Throw LP	LP Factory Orifice	BTU's Natural/Propane
FPB-G16RBSMT-N	#35	FPB-G16RBSMT-P	#47	45,000
FPB-G25RBSMT-N	#29	FPB-G25RBSMT-P	#41	65,000
FPB-G29RBSMT-N	#29	FPB-G29RBSMT-P	#41	65,000
FPB-G33RBSMT-N	#29	FPB-G33RBSMT-P	#41	65,000
FPB-19RBSMT-N	#29	FPB-19RBSMT-P	#41	65,000
FPB-25RBSMT-N	#29	FPB-25RBSMT-P	#41	65,000
FPB-20SBSMT-N	#29	FPB-20SBSMT-P	#41	65,000
FPB-26SBSMT-N	#29	FPB-26SBSMT-P	#41	65,000
FPB-32SBSMT-N	#29	FPB-32SBSMT-P	#41	65,000
FPB-38SBSMT-N	#29	FPB-38SBSMT-P	#41	65,000

Table 2. Btu Specifications

Disclaimer: Btu listings are based on 7.0"WC for Natural Gas and 11.0"WC for Liquid Propane (LP) at the burner orifice. Flex line size and proper gas pipe sizing will also affect Btu's. As a result your Btu's may vary slightly from Table 2 specifications.

Pressure	NG	LP
Min. Inlet	3.5" WC	8.0" WC
Max. Inlet	10.5" WC	13.0" WC
Normal Inlet	7.0" WC	11.0" WC

Table 3. Gas Pressures

WARNING: Proper clearances from combustible materials must be maintained from all sides, top and bottom of this appliance. Use the specifications listed on page 3 for proper clearance to combustibles.

PREPARING A NON-COMBUSTIBLE STRUCTURE

The fire pit can be installed on a flat, stable surface, away from any combustible materials. Install Fire pit on any level, outdoor non-combustible, flat stable surface or a combustible floor according to the clearances specified in this manual.

NOTE: Do not place fire pit directly on grass, dirt, or rocks this may prevent proper ventilation (Fig.1, pg. 3). **Ensure proper water drainage is also incorporated into the fire pit enclosure.**

HARD PIPING TO Fire pit WITHOUT GAS PROXIMITY

NOTE: We recommend using 3/4" black iron pipe; however please refer to the NFPA54 (National Fuel Gas Code) for proper pipe sizing when exceeding 20-feet in length for fire pits rated above 100,000 Btu's.

1. Turn **OFF** gas supply system. **NOTE:** All gas connections (except for brass to brass) require the following. Clean pipe threads using either a wire brush or steel wool. Apply pipe sealant to the fittings before making any connection.

BE CAREFUL! Ensure all gas connections are snug, but do not over tighten!

2. Extend the gas supply system using minimum of 3/4" black iron pipe or an approved flexible gas line from existing house supply. This can be accomplished by teeing off or tapping into a gas line connection. Install necessary pipe for the distance required and then install a manual shut-off valve at the exterior house wall. If pipe is to pass through a foundation or house wall, make sure to re-seal the area around the pipe with weather sealant.

3. The primary gas shut-off (not supplied) will require a 1/2" male flared fitting to enable connection of the stainless steel flex gas line supplied with the fire pit (see figure 5 page 6).

IMPORTANT

Installation of Natural or LP gas should be done by a qualified installer, service agency or gas supplier.

This appliance must be isolated from the gas supply piping system by closing its manual shutoff valve during any pressure testing of the gas supply piping system at test pressures equal to or less than 1/2" psig (3.5kPa)

VENTILATION FOR NON-COMBUSTIBLE ENCLOSURE

Fire pits are subjected to many outdoor elements such as rain, snow, wind, heat or cold. **A minimum of 18 square inches of cross ventilation (2 sides) is required to keep the components in good working order.** Use figure 3 as guide to assist to incorporate proper ventilation.

HIGH ELEVATION INSTALLATION

This appliance is listed for elevations from 0- 4500 feet in Canada and the U.S. If elevation exceeds 4500 feet it may be necessary to decrease the input rating by changing the existing burner orifice to a smaller size. Input should be reduced 4% for each 1000 feet beyond the 4500 feet above sea level. Check with your local gas utility for assistance in determining the proper orifice in your location. In some cases the heating value may already be reduced and downsizing the orifice may not be necessary.

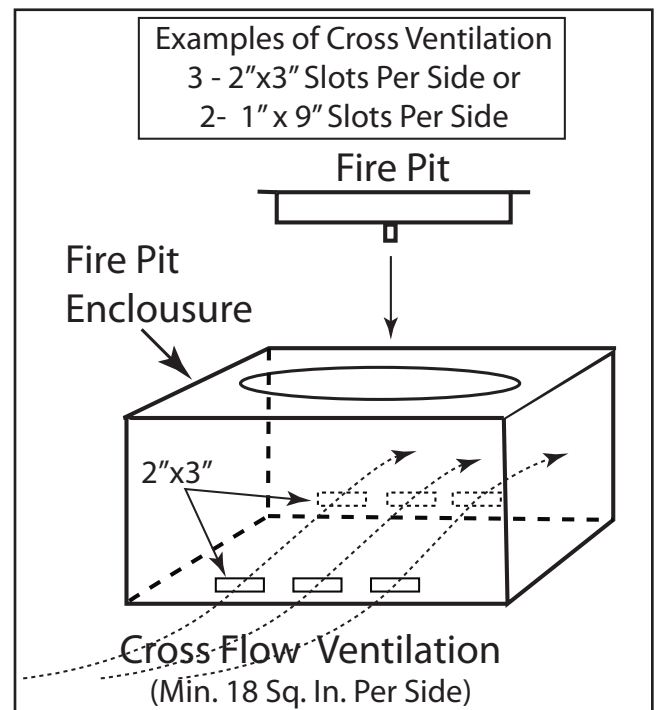

Figure 3. Cross Ventilation Example

INSTALLATION OF FIRE PIT INTO AN APPROVED ENCLOSURE

REQUIREMENTS

1. Only non-combustible materials should come in direct contact with any part of the fire pit. Underneath area should be non-combustible or a flat level combustible surface according to the clearances specified in this manual..
2. We recommend using 3/4" black iron pipe; however please refer to the NFPA54 (National Fuel Gas Code) for proper pipe sizing when exceeding 20-feet in length for fire pits rated above 100,000 Btu's.
3. Determine the size of the round or square fire pit you are preparing to install (Refer to page 3).
4. You must provide a round or square opening out to place the fire pit into the non-combustible enclosure. Do not exceed the maximum opening from Table 1, dimension B.
5. Follow the local code requirements for the gas type being used. This fire pit should be installed in accordance with local codes and ordinances or in the absence of local codes, with the latest National Fuel Gas Code, ANSI Z223.1 NFPA54 or CSA B149.1, Natural and Propane Installation Code in Canada.
6. Fire pits create high temperatures, it is very important to have any combustibles at a safe distance.
7. **CAUTION: A minimum of 18 square inches of cross ventilation (per side) is required to keep the enclosure dry.**
8. These products are designed for outdoor use only. Not approved for any indoor use.
9. This fire pit is designed to have lava rock completely covering the spur burner, so that the burner is not visible. Do not cover more than 1" above the top of the covered burner. When purchasing lava rock use 1" diameter as a base to fill the burner pan.
10. Gas lines and fittings must be installed in to the non-combustible structure. All gas connections must be leak tested before installation of the fire pit. Soapy water leak detection is required before regular use of the fire pit.
11. Do not use material that will absorb moisture over time and will not release this moisture quickly. Moisture can boil in this material and can rapidly break apart and cause damage or personal injury.
12. Never leave any other combustible material on top of the fire pit. This could cause unsafe operation of this system and damage to the component that will not be covered under our warranty.
13. **Ensure proper water drainage is also incorporated into the fire pit enclosure.**

INSTALLING KEY VALVE

The key valve contents: 1- key valve, 1- key and 1- flange. (See figure 4). The valve requires a 1¼" round clearance hole in the non-combustible enclosure wall. See the instructions supplied with the key valve for more specific details. Note: Be sure to leak test all fitting before operation. Figure 5 shows an example of a typical installation.

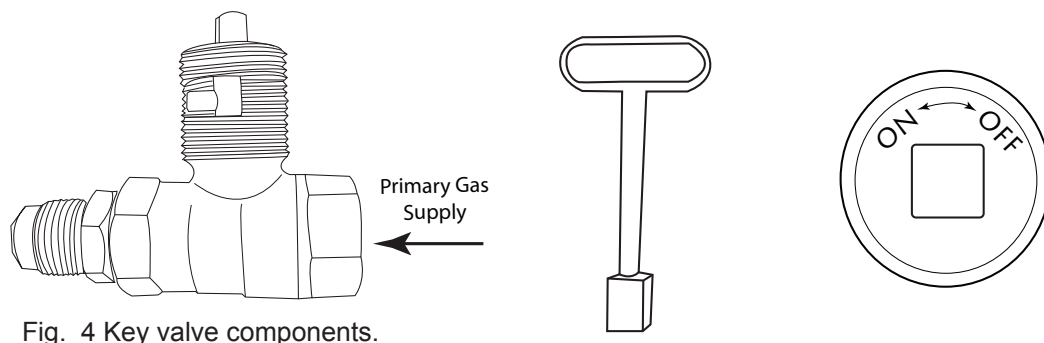
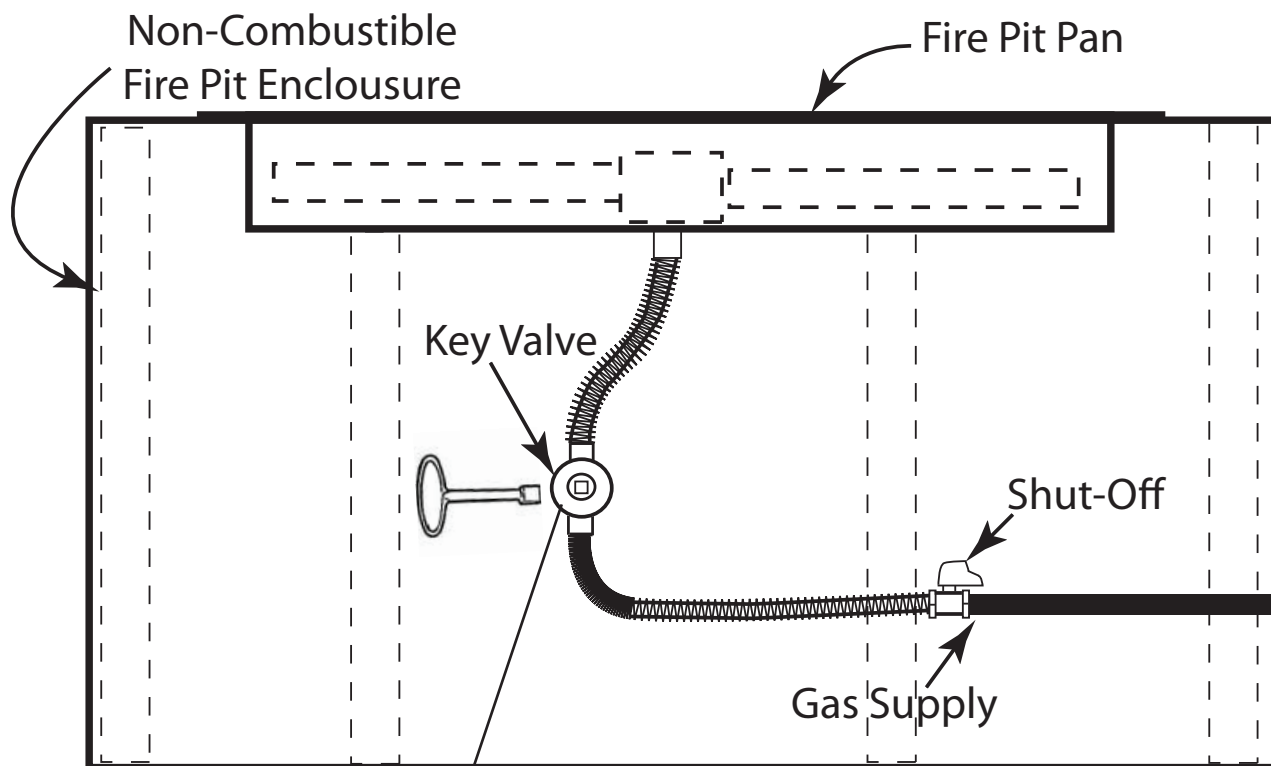
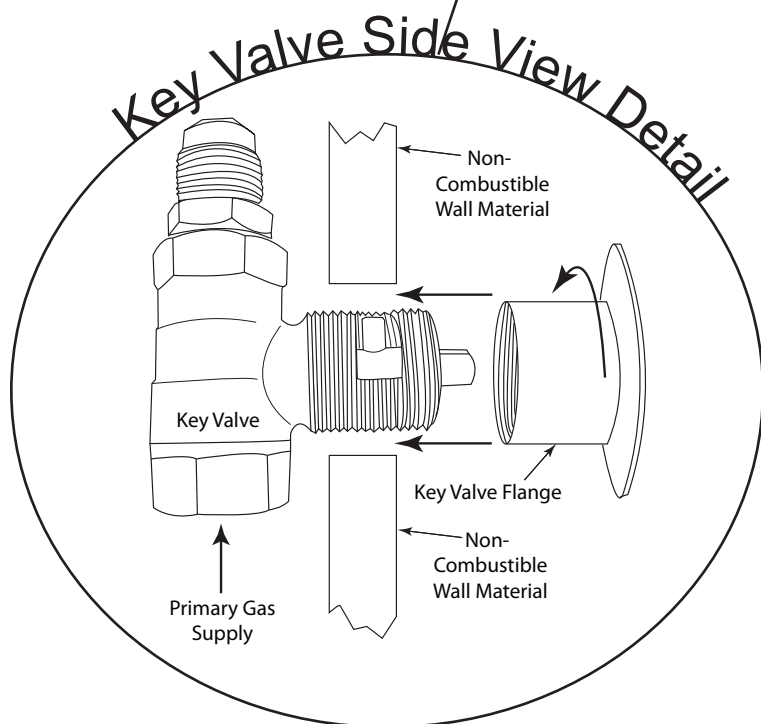

Fig. 4 Key valve components.



NOTE: Key valve and flexible gas lines are supplied. Gas shut-off is not supplied.



Note: A 1¼" x 2" black iron or galvanized coupler/nipple (not supplied) can be used as a spacer between the manual valve and the valve flange to add additional support to hold the manual key valve in place.

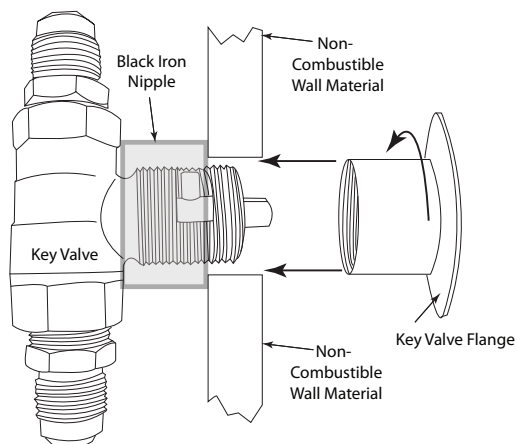

Fig. 5 Typical installation.

OPERATION

CAUTION: Children and adults should be alerted to the hazards on high surface temperatures and should stay away to avoid burns or clothing ignition. Young children should be carefully supervised when they are in the area of the appliance.

WARNING: Do not use this appliance if any part has been under water. Immediately call a qualified service technician to inspect the appliance and to replace any part of control system and any gas control, which has been under water.

SAFETY WARNINGS

1. Never leave the fire pit unattended during operation.
2. Clothing or other flammable materials should not be placed on or near the appliance.
3. Any guard or other protective device removed for servicing the appliance must be replaced prior to operating the appliance.
4. Installation and repair should be done by a qualified service person. The appliance should be inspected before use and at least annually by a qualified service person. More frequent cleaning may be required as necessary. It is imperative the control compartment, burners and circulating air passageways of the appliance be kept clean.
5. Inspect the fuel supply connection before each use of the appliance.
6. Temporary storage of this appliance indoors is permissible only if it has been disconnected from its fuel supply (Natural or L.P. gas line).

WARNING

1. This appliance is hot when operated and can cause severe burns if contacted.
2. Do not burn any solid fuels in this appliance.

LIGHTING INSTRUCTIONS

READ ALL WARNING AND SAFETY INFORMATION ABOVE BEFORE ATTEMPTING TO LIGHT FIRE PIT

CAUTION: Ensure you have leak tested the fire pit before operating.

TURNING ON FIRE PIT

1. Insert key into shut-off valve and secure into square end (see figs 6 & 7).
2. Light a long match or butane lighter and hold it near the burner.
3. Turn the key counter-clockwise in gas valve (until it stops) to allow gas to flow and simultaneously apply the long burning match or Butane lighter as close to the end burner as possible to light the fire pit.
4. Gas should ignite within 10 seconds or less. If fire pit does not light within 10 seconds turn key clockwise to turn **OFF** the gas supply. Ensure there is not too much media on top of the burner that might inhibit gas flow and try again in 5-minutes.

TURNING OFF FIRE PIT

1. Insert key into shut-off valve and secure into square end.
2. Turn key clockwise until it stops.
3. After cooling off install cover.

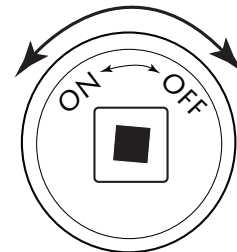

Fig. 6. Key Valve Face

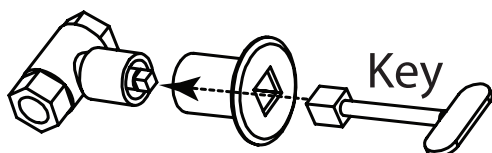

Fig. 7 Inserting Key into Valve

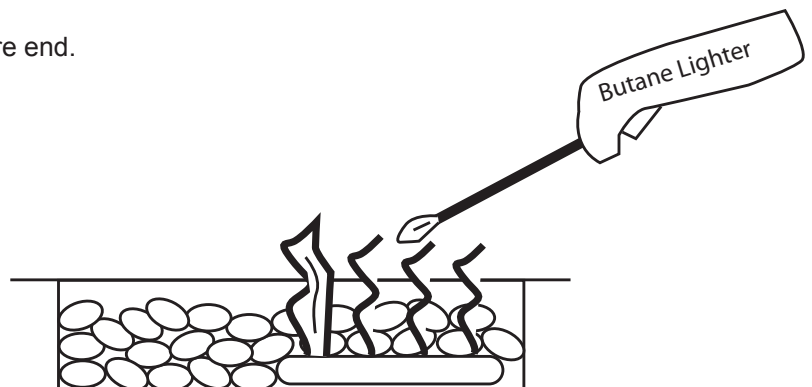
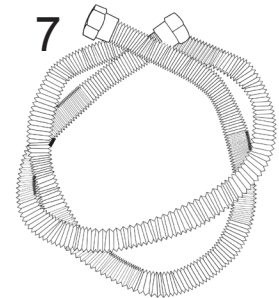
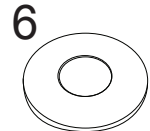
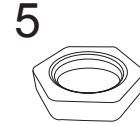
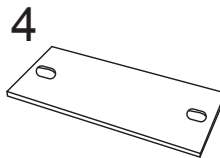
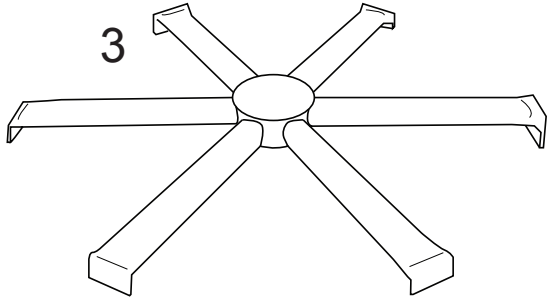
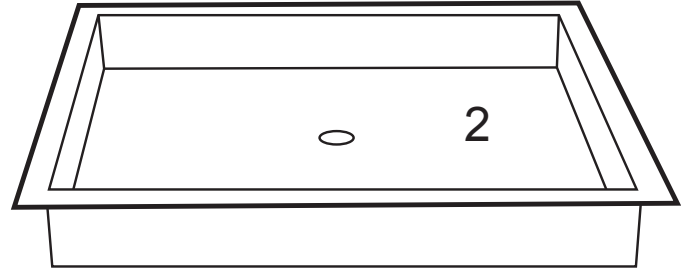
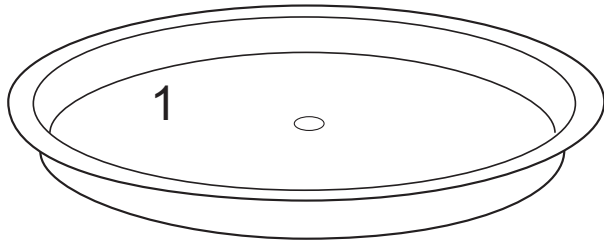
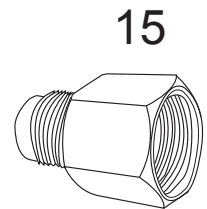
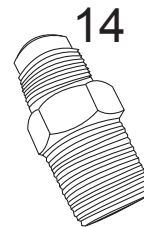
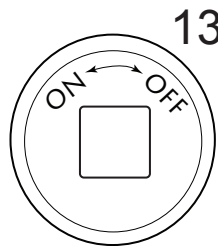
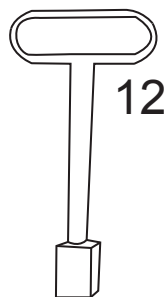
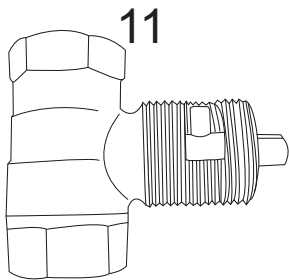
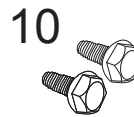
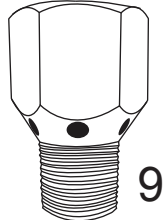
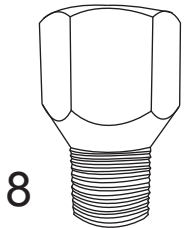

Fig. 8 Lighting fire pit with lighter

MT REPLACEMENT PARTS



Drawings are not proportioned.



MT REPLACEMENT PARTS

Item	Description	Qty.	Part Number
1	16-inch G90 Round Galvanized Black Pan	1	Pan-GV16R
1	25-inch G90 Round Galvanized Black Pan	1	Pan-GV25R
1	29-inch G90 Round Galvanized Black Pan	1	Pan-GV29R
1	33-inch G90 Round Galvanized Black Pan	1	Pan-GV33R
1	19-inch Round Stainless Pan	1	Pan-SS19R
1	25-inch Round Stainless Pan	1	Pan-SS25R
2	20-inch Square Stainless Pan	1	Pan-SS20S
2	26-inch Square Stainless Pan	1	Pan-SS26S
2	32-inch Square Stainless Pan	1	Pan-SS32S
2	38-inch Square Stainless Pan	1	Pan-SS38S
3	12-inch Spur (used on 16" Pans)	1	B-Spur12
3	16-inch Spur (used on 19" & 20" Pans)	1	B-Spur16
3	22-inch Spur (used on 25", 26", 29", 32", 38" Pans)	1	B-Spur22
4	1 x 2¼" Blank Cover Plate	1	ST3-100-1030
5	1/2" NPS Brass Nut	1	ST3-113-1027
6	7/8" Flat Washer/Spacer	1	ST3-113-1026
7	1/2" Flex Gas Line (46-inch Length)	1	T-200-9898-46
8	Air Shutter Orifice NG (See note below)	1	OAS-NG29
8	*Air Shutter Orifice NG (Used on Natural Gas Models)	1	OAS-NG35
9	Air Shutter Orifice LP (Used on Propane Models)	1	OAS-LP41
9	*Air Shutter Orifice LP (See note below)	1	OAS-LP47
10	Stainless Steel Screws for cover plate (not shown)	2	ST3-113-1028
11	Standard Capacity Straight Ball Valve	1	BVS
12	8-inch Chrome Key for BVS	1	KEY-PC/8
13	Chrome Flange (decorative cover for BVS)	1	FP.BV.CR.B
14	½" NPT Male to ½" Male Flare Fitting	1	U1-8D-S
15	½" NPT Female to Male Flare Fitting	1	U3-8D-S

* These air shutter/orifices are used only with FPB-G16RBSMT models.

FIRE PIT MAINTENANCE





1. The fire pit should be inspected and cleaned before initial use at least annually by a qualified field service person.
2. Any component that is found faulty must be replaced with an approved component.
3. Any tampering or modifying with the fire pit is dangerous and voids all warranties.
4. During winter months in cold climates and various seasons operation the fire pit may be affected by weather conditions. It is recommended to use a ventilated cover overtop of your fire pit to protect it from humid/rainy weather conditions when not in use. Heavy rains/downpours could affect the fire pit operation if not covered; if this occurs ensure you allow the fire pit time to dry out before attempting to operate. **NOTE:** If a combustible type cover is used over the fire pit when not in use be sure to remove it before operation to prevent a severe safety hazard.
5. Over time galvanized or stainless steel parts can discolor when heated, usually a golden or brown hue. This discoloration is normal and does not affect the performance of the appliance.

TROUBLE SHOOTING

<u>Symptom</u>	<u>Remedy</u>
Fire pit won't light	<ol style="list-style-type: none"> 1. Bleed gas line. 2. Ensure all gas supply lines are turned ON. 3. Ensure there is not too much media overtop of burner; it can inhibit gas from flowing. 4. Check gas pressure.
Low flame	<ol style="list-style-type: none"> 1. Ensure the base media is at least 1-inch in diameter and top media is no more than 1-inch over top of burner. 2. Ensure all shut-off valves and key valve is fully open. See page 7; figure 6 3. Check gas pressure.
Water in my fire pit	<ol style="list-style-type: none"> 1. Excess dust/sand material from media may be blocking the weep holes to relieve water. Remove all media and unplug weep holes. Clean or install new media free of dust and dirt. 2. Ensure fire pit enclosure has proper drainage for water and proper ventilation to dry out.

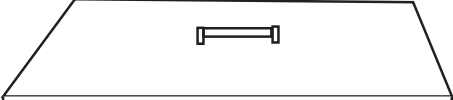
OPTIONAL ACCESSORIES

The following accessories are available from your local Firegear dealer/distributor.
Each accessory comes with a separate installation manual. Read each instruction thoroughly before installing.

		
<p>Stainless Round Lid for 16" - 33" Pits Models: LID-16R, LID-19R or LID-25R</p>	<p>Stainless Square Lid for 14" - 32" Pits Models: LID-14S, LID-20S, LID-26S, LID-32S, LID-38S</p>	<p>Conversion Kit: Converts fire pit from Natural to LP Gas. Includes: O/AS, rating plate label sticker and instructions</p>
		<p>Model: LPK#47 For Model: FPB-G16RBSMT-P</p>
<p>Lava Stones 1" to 2" size. (20lbs.) Model: FG-LS20</p>	<p>Lava Boulders 6" to 12" size (30lbs.) Model: FG-LB30</p>	<p>Model: LPK#41 For Models: FPB-G25/29/33RBSMT-P FPB-19/25/20/26/32/38RBSMT-P</p>

FOR TECHNICAL SERVICE, CALL: (855) 498-8324

Firegear Outdoors
9230 Conservation Way
Fort Wayne, IN 46809
For Sales: (888) 672-8929

WEB SITE: www.firegearoutdoors.com