

ELECTRIC INFRARED HEATERS



SUPERIOR
RADIANT PRODUCTS



SERIES eWAVE™



WARNING

The manufacturer's instructions, the layout drawing, national and local codes and ordinances, and all applicable standards which apply to electrical wiring comprise the basic information needed to complete the installation. These criteria must be thoroughly understood before proceeding.

Only personnel who have been trained and understand all applicable codes should undertake the installation. Manufacturer representatives are Factory Certified in the service and application of this equipment and can be called on for helpful suggestions about installation.

Canada: 563 Barton Street, Stoney Creek, Ontario L8E 5S1

USA: 315 N Madison Street, Fortville, IN 46040

www.superiorradiant.com

CONTENTS

APPLICABLE CODES AND STANDARDS.....	2
TERMINOLOGY.....	2
HEAT REQUIREMENT – SPOT HEATING	3
COVERAGE AREA – FOR SINGLE HEATER	3
RADIANT INTENSITY PATTERN	4
RADIANT INTENSITY AT DIFFERENT DISTANCE FROM HEATER	5
COVERED AREA VS INSTALLATION HEIGHT	6
DISTANCE BETWEEN HEATERS	7
COVERING THE AREA WITH DIFFERENT MODELS.....	8
RADIANT PATTERN OF AN ANGLED HEATER.....	9
CLEARANCE TO COMBUSTIBLES	10
INSTALLATION – SUPPORT MOUNTING	11
DISCLAIMER.....	11
TECHNICAL SPECIFICATIONS	12

Applicable Codes and Standards

Installation of this heater shall be in accordance with local codes, or in the absence of local codes, the National Electrical Code, NFPA 70, or the Canadian Electrical Code, Part 1, C22.1.

The eWAVE heater is designed and manufactured for residential / commercial heating applications for indoor and outdoor use, according to the Standard for Fixed and Location-Dedicated Electric Room Heaters, UL 2021, and the Canadian Standard for Electric Air Heaters, CSA C22.2 No. 46.

Terminology

Thermal comfort

That condition of mind which expresses satisfaction with the surrounding thermal environment and is assessed by subjective evaluation. Thermal comfort is affected by heat conduction, convection, radiation, evaporative heat loss, and relative air motion.

Watt (W)

A unit of energy measurement equal to 3.412 BTU/hr.

Kilowatt (kW)

A unit of energy measurement equal to 3412 BTU/hr. one kilowatt = 1000 watts.

Heat requirement

Level of applied energy, expressed in BTU/hr/ft², needed for minimum thermal comfort.

Coverage area

Area provided radiant output from a heater, at a given distance from the heater, where energy levels are sufficient to maintain an average comfort zone.

Installation height

Heater mounting distance above floor, measured in feet.

Heat Requirement – Spot Heating

Radiant Heat Requirement for General Comfort for Varying Air Temperature & Wind Conditions

Ambient Temperature	Radiant Intensity at floor level (BTU/h/ft ²)	
	Wind Conditions	
°F	Still Air (0-1 mph)*	Breezy (2-3 mph)
35	55	67
45	38	55
55	25	35

*1 mph = 1.5 fps = 0.45 m/s; for indoor spaces; utilize Still Air heat levels for indoor spaces.

Coverage Area – for single heater

The coverage area directly below the heater is calculated to provide the required level of comfort at specified conditions: Air Temperature, Wind Conditions, and Installation Height for different heater power levels.

Long Wave	Recommended Coverage Area (L x W) (ft x ft)			
	8ft		10ft	
Installation Height →	Wind Conditions		Wind Conditions	
Temperature ↓	Still Air	Breezy	Still Air	Breezy
°F	Still Air	Breezy	Still Air	Breezy
4500 W				
35	12 x 11	8 x 4	10 x 7	12 x 12 (8ft apart)*
45	16 x 13	12 x 11	14 x 11	10 x 7
55	20 x 16	18 x 14	18 x 15	16 x 12
3000 & 3200 W				
35	10 x 8	10 x 10 (5ft apart)*	10 x 10 (7ft apart)*	10 x 8 (4ft apart)*
45	12 x 10	10 x 8	10 x 6	10 x 10 (7ft apart)*
55	18 x 14	14 x 12	16 x 12	10 x 8
1500 W				
55	8 x 5	-	10 x 12 (4ft apart)*	-

Medium Wave	Recommended Coverage Area (L x W) (ft x ft)			
	9ft		12ft	
Installation Height →	Wind Conditions		Wind Conditions	
Temperature ↓	Still Air	Breezy	Still Air	Breezy
°F	Still Air	Breezy	Still Air	Breezy
1800W				
45	10 x 7	10 x 10 (6ft apart)*	8 x 6	10 x 8 (6ft apart)*
55	12 x 10	10 x 7	10 x 8	8 x 6

* - identifies conditions where single indicated heater is not recommended. The desired radiant intensity can be achieved by using more than one heater, overlapping heat patterns. For these cases, the recommended distance between heaters is provided. **Example:** For an ambient temperature of 35 F and wind conditions “Breezy” two long wave heaters with 4500 W input mounted 10 feet above the floor, provide a comfort zone coverage area 12ft x 12ft when installed 8ft apart.

Radiant Intensity Pattern

The radiant intensity on a surface or floor at a given distance from the heater follows a pattern as shown below. Understanding the radiant intensity pattern allows the designer to consider location of objects relative to the heater when designing for customer comfort.

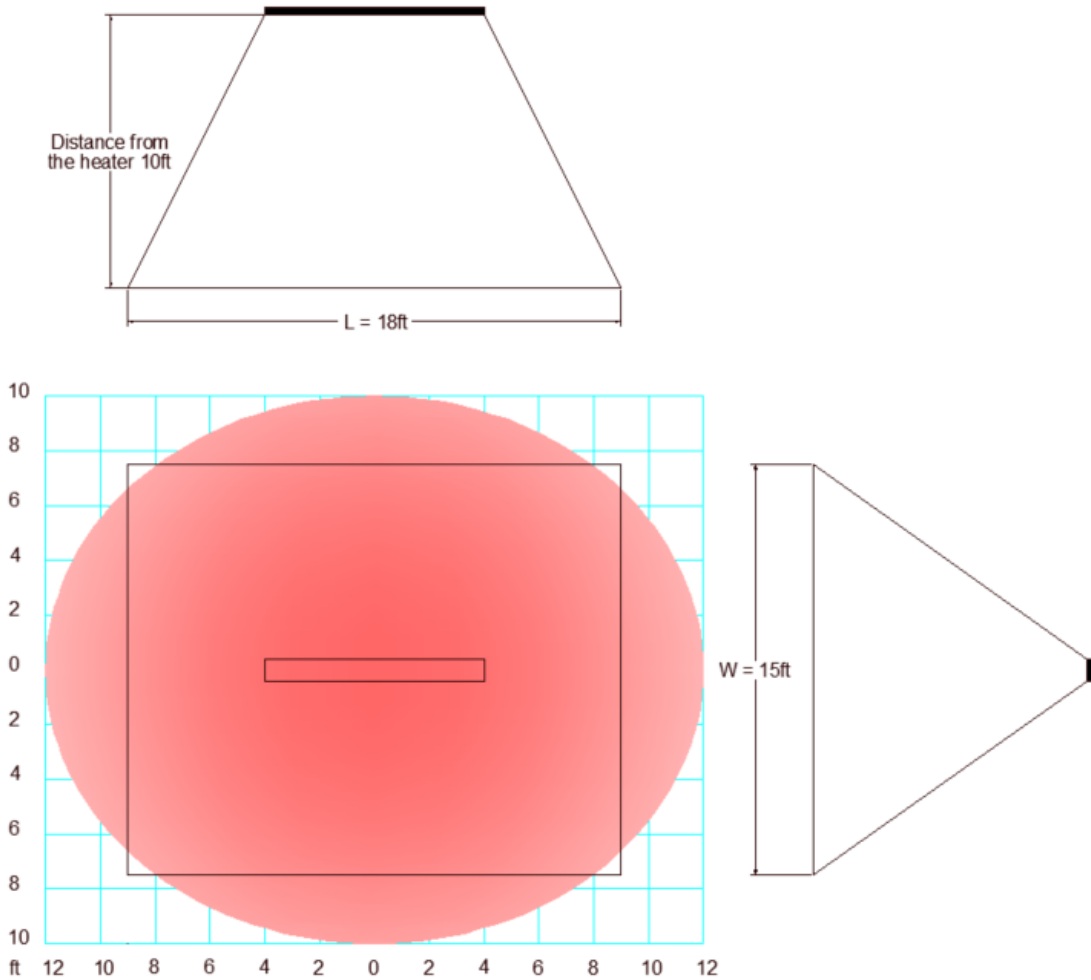

Example: For an ambient temperature of 55 F and wind conditions 0-1 mph (still air), a long wave heater with 4500 W input mounted 10 feet above the floor, provides a comfort zone coverage area $18\text{ft} \times 15\text{ft}$ (270ft^2).

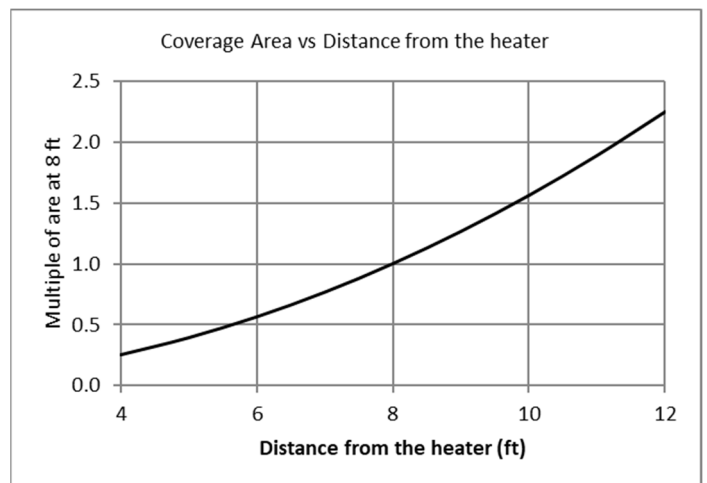
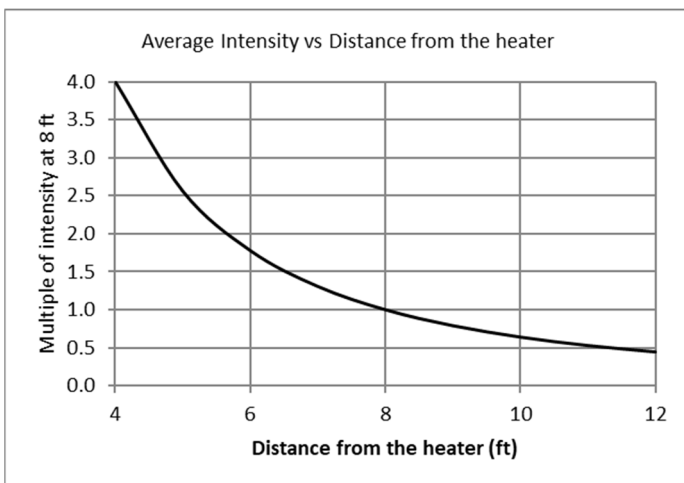

Radiant Intensity at Different Distance from Heater

The patterns on the right illustrate radiant intensity at different distances from the heater. Closer to the heater the intensity is more focused. Although the heated areas are smaller, the level of energy is higher. Closer to the heater is “warmer”. A person only 6 ft from the heater will experience approximately twice as much energy as a person 10 ft from the heater.

A person sitting under a heater will experience higher radiant intensity at the shoulder level relative to the lower parts of body. This should be considered as part of the designing process.

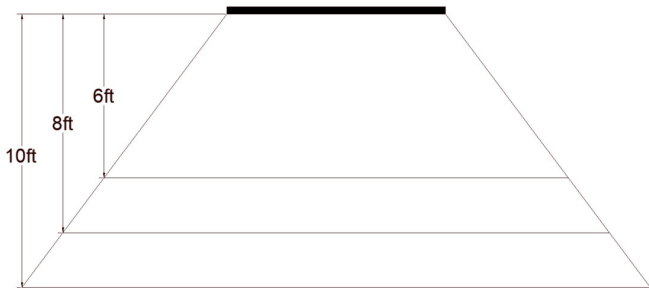

Distance from the heater

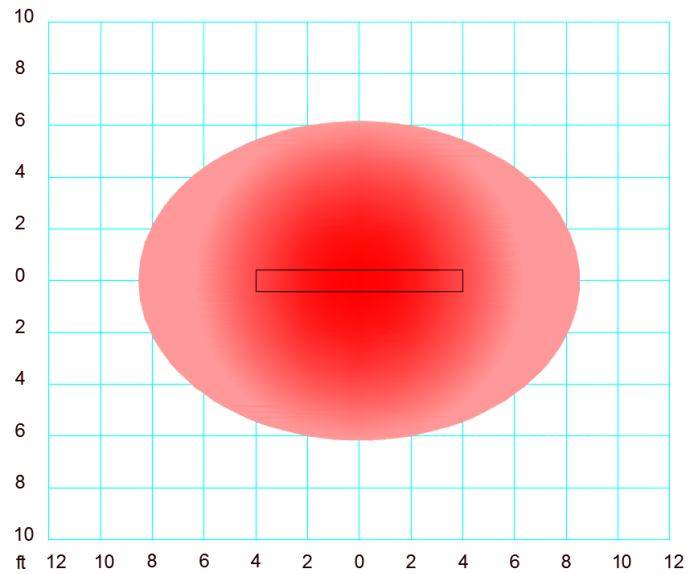

Intensity pattern at 6ft from the heater

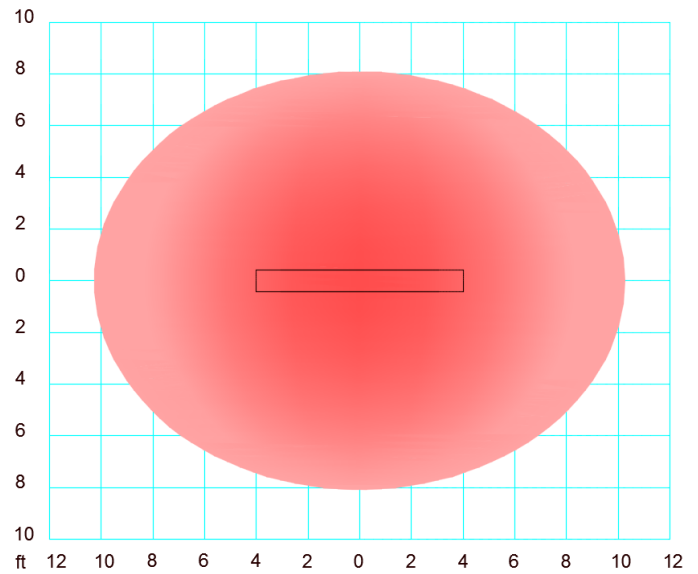

Intensity pattern at 8ft from the heater

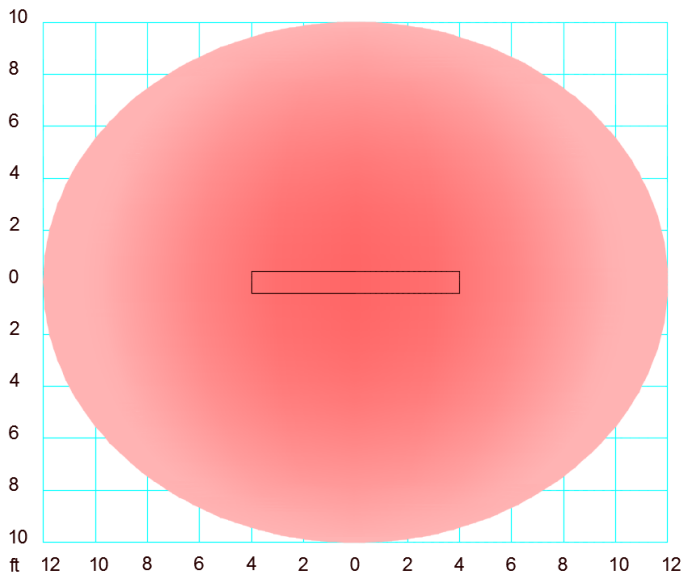

Intensity pattern at 10ft from the heater

Covered Area vs Installation Height

As noted previously, as distance between the heater and a surface or the floor changes, the radiant energy density changes. As distance increases, the radiant output pattern from a heater is spread over a larger area, decreasing energy density. The effective area at a given energy density is therefore smaller. Conversely, as a heater moves closer to a surface or floor, the radiant output pattern is focused on a smaller area, increasing energy density. The effective area at a given density is therefore larger.

To provide comfort to customers at differing mounting heights, we must provide the same nominal levels of energy at the surface or floor. To accomplish this, the coverage area is changed to maintain comfort. One straight forward method to account for this difference involves adjusting the effective coverage area for comfort at a given height.

The example below demonstrates these concepts and shows the effective coverage areas for equal levels of comfort below the same heater (4500 W), installed at 8 ft or 10 ft from the floor.

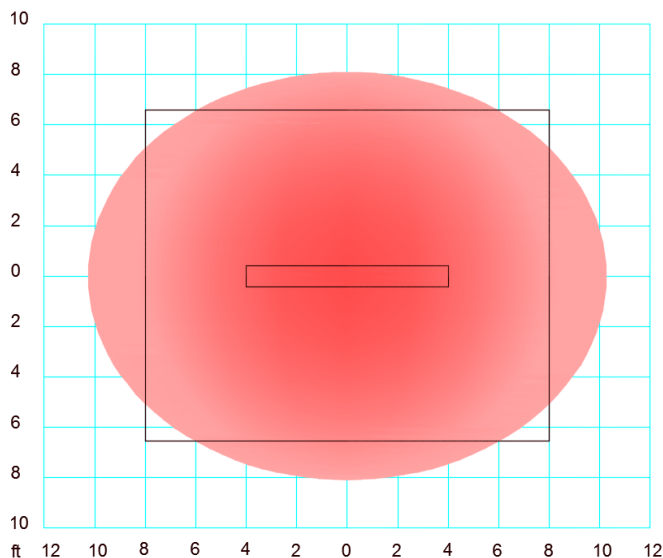
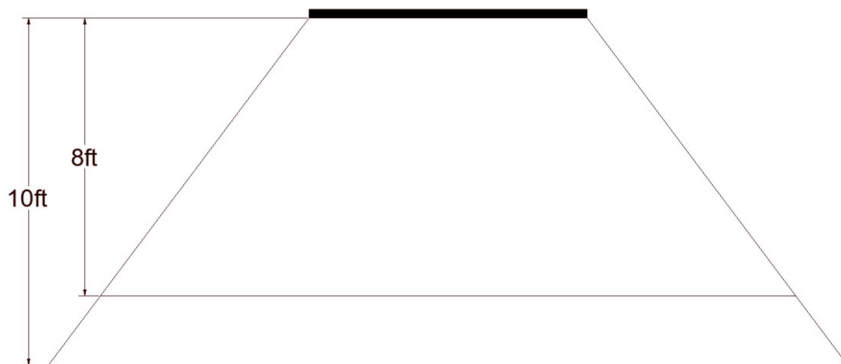

Installation height 8ft

Coverage area: 16ft x 13ft

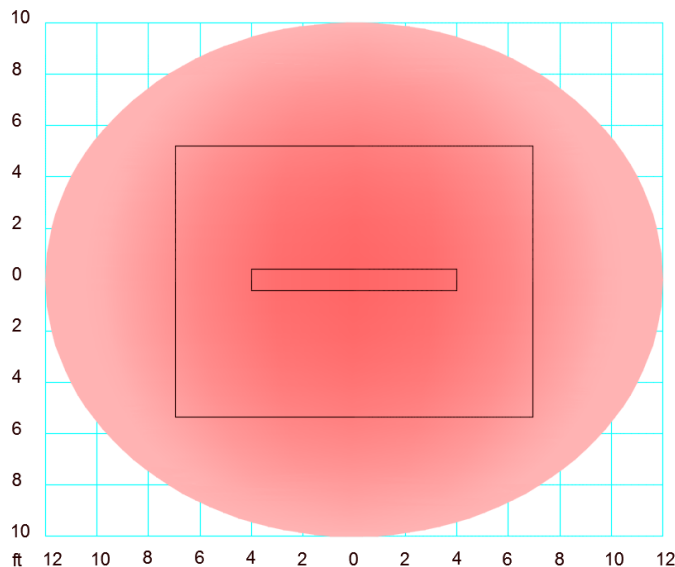

Installation height 10ft

Coverage area: 14ft x 11ft

Distance Between Heaters

By knowing the coverage area of the heater, you can estimate the spacing required between the heaters to maintain an adequate comfort zone in the space (maintain adequate radiant intensity pattern).

The examples below utilize the same 4500 W heater, at 8 ft mounting height, for a 55 F air temperature in still air, with a recommended effective coverage area of L=18ft by W=15ft. Notice that “end-to-end” heater placement is 18 ft on center, and “side-to-side” heater placement is 15ft on center.

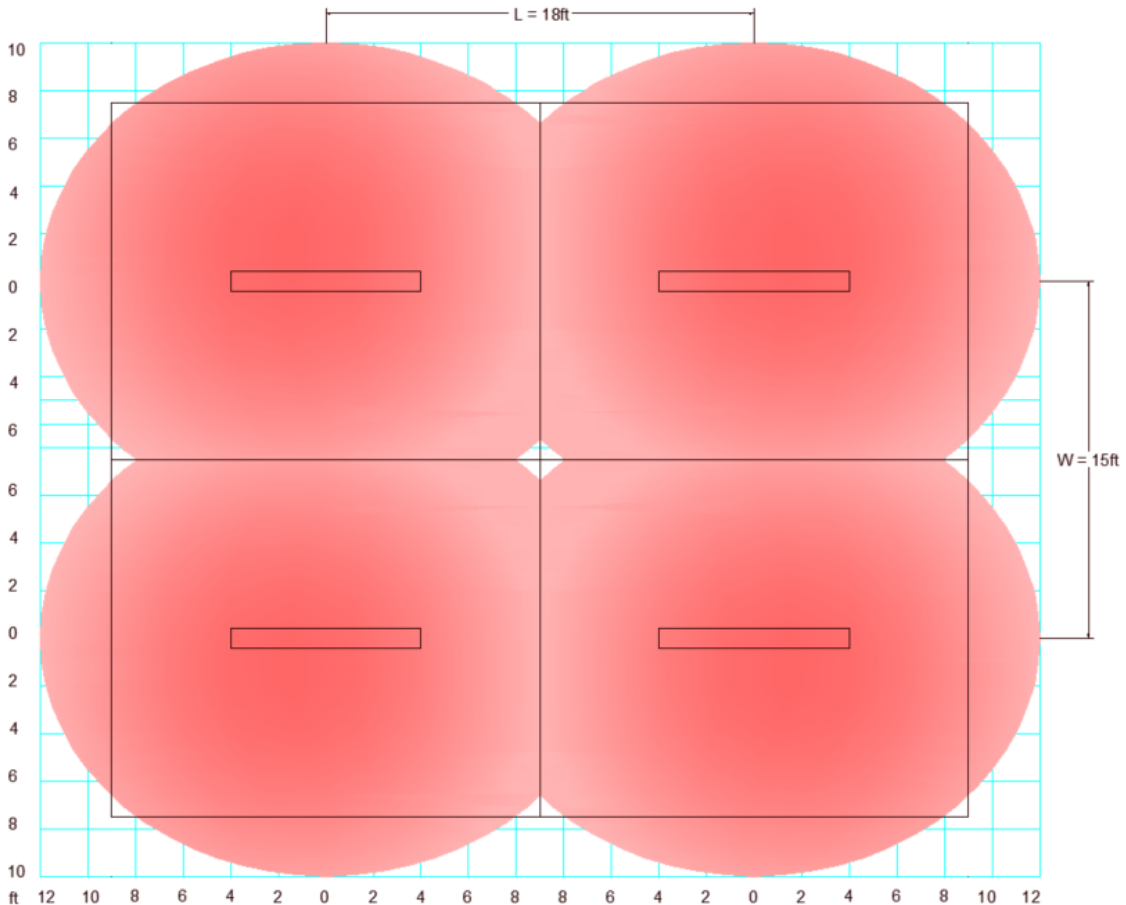
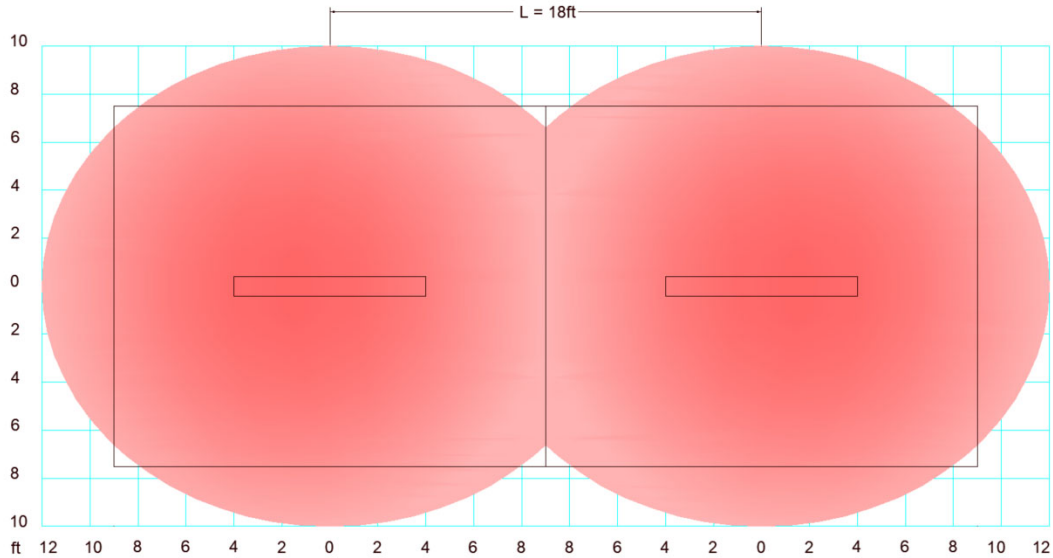

Covering the area with different models

The same area can be covered by different heater models. For the long wave heaters, the heater emitter temperature is the same, so the same radiant intensity can be realized by installing different type of heaters. In the example below the same area is covered by 4 x 4500W and 6 x 3000. The solutions with higher number of heaters have the flexibility of combining the operation sequence of different heaters to achieve different desire radiant intensity.

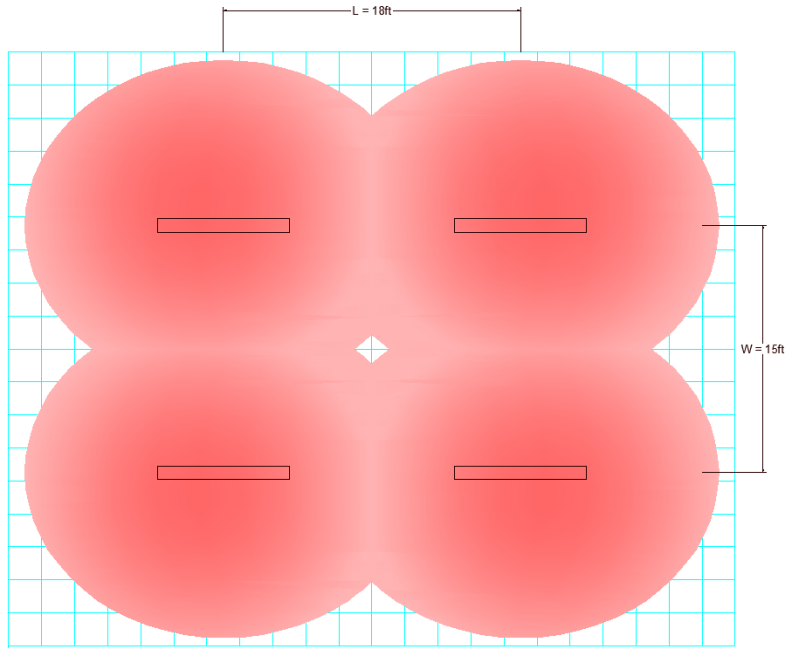

$$4 \times 4,500W = 18,000 \text{ W}$$

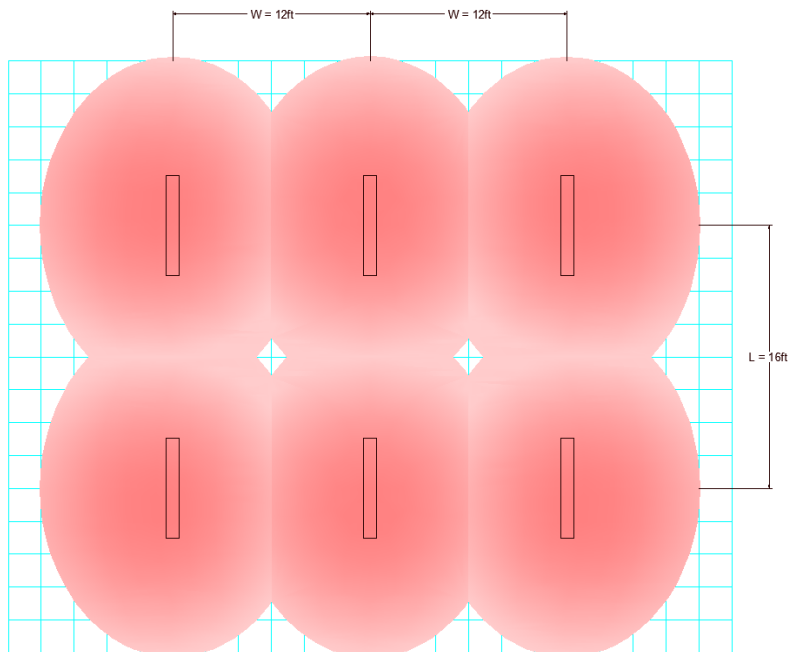

$$6 \times 3,000 \text{ W} = 18,000 \text{ W}$$

Radiant Pattern of an Angled Heater

Considerations should be given when installing the heater on the angle. When heaters are tipped, the radiant output intensity is distributed with a different pattern than when mounted horizontally. Utilizing the same 4500 W heater and conditions as in other examples, the figures below illustrate the changes in output distribution that result from a 20-degree mounting angle.

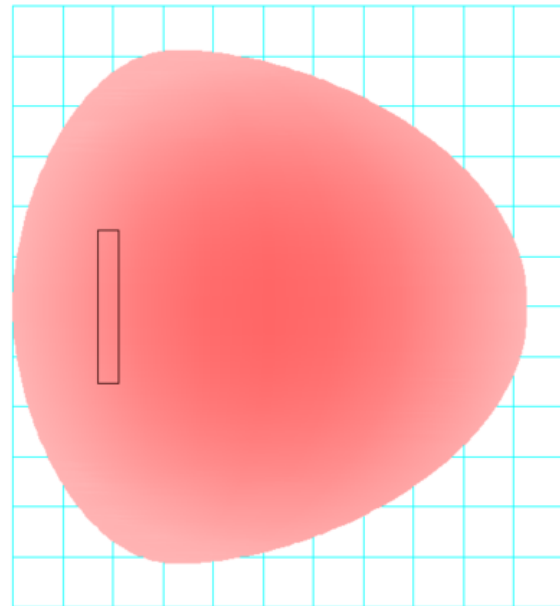
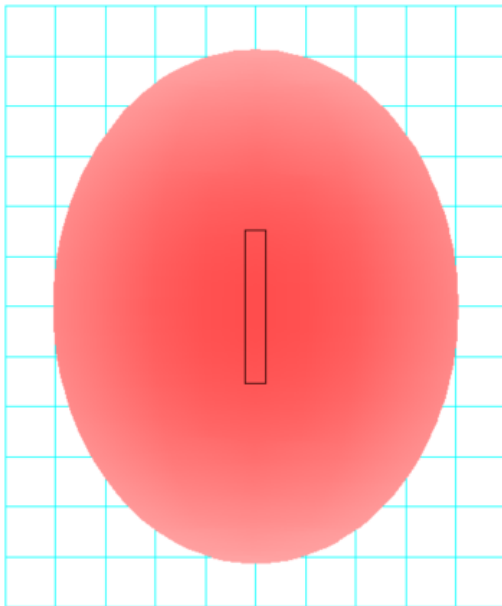
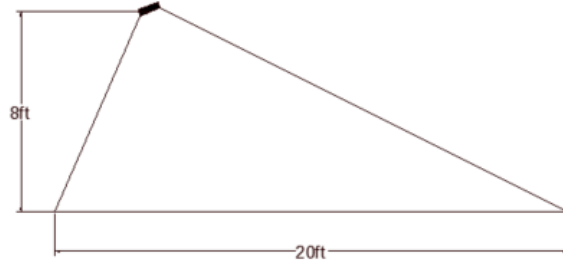
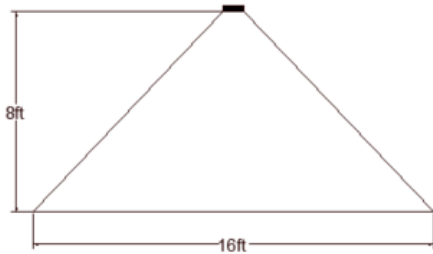

The charts below variation of radiant intensity and covered area on the floor at different tipping angles compared to horizontal mounting.

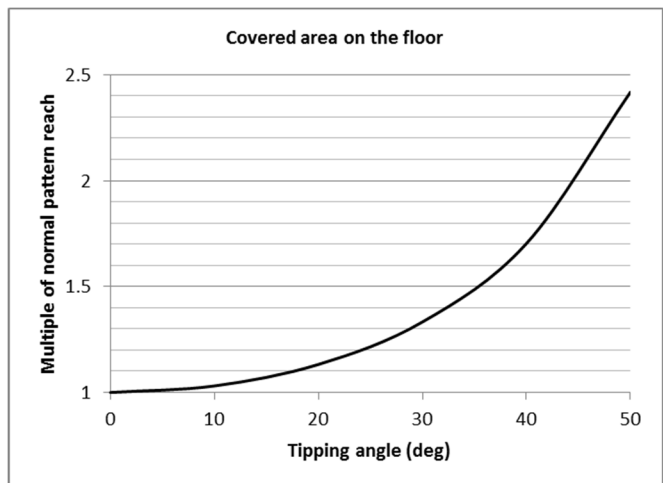
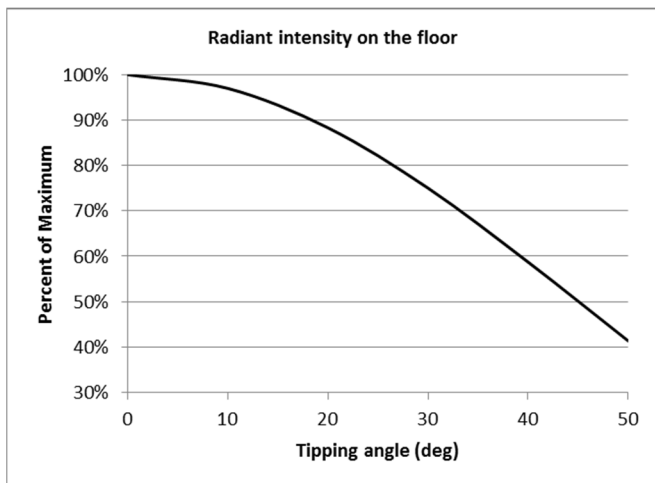

Clearance to Combustibles

1. The minimum clearance from the floor to the heater shall be 8 ft (243cm).
2. The minimum clearances from the ceiling, walls and other objects are shown in the pictures below.
3. The stated clearance to combustibles represents a surface temperature of 117°F (65°C) above room temperature.
4. Building materials with low heat tolerance (i.e. plastics, vinyl siding, canvas, tri-ply, etc.) may be subject to degradation at lower temperatures. It is the installer's responsibility to ensure that adjacent materials are protected from deterioration.

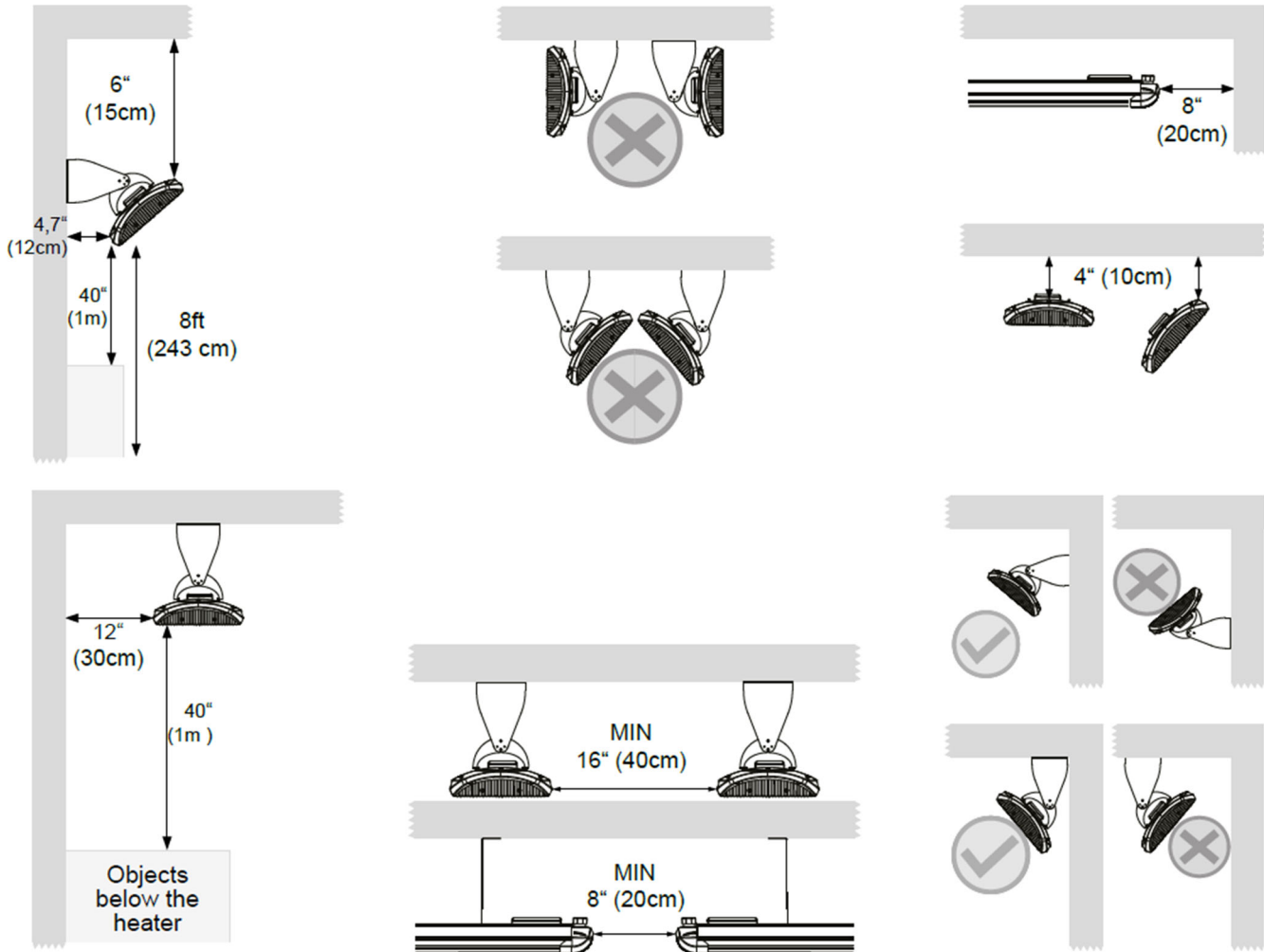

Some parts of this product can become very hot and cause burns. Particular attention must be given where children and vulnerable people are present.



Once the product is powered, it automatically goes into ON mode. It will take a few minutes after powering on to reach the maximum temperature.

Installation – Support Mounting

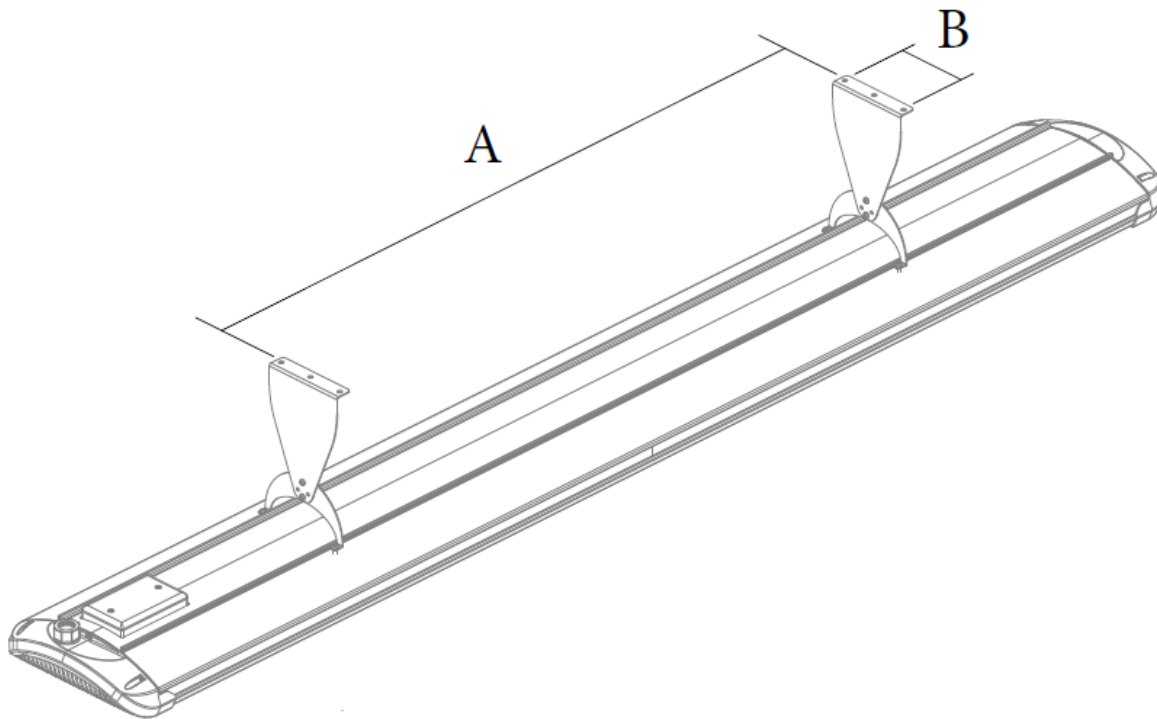

See detailed information in the technical specification chart.

Disclaimer

The information in this document is provided for educational and information purposes only.

Thermal comfort represents that condition of mind which expresses satisfaction with the surrounding thermal environment and is assessed by subjective evaluation. Thermal comfort is affected by heat conduction, convection, radiation, evaporative heat loss, and relative air motion.

The information in this document is directed to those who have the appropriate degree of experience to use and apply its contents.

SRP does not warrant the accuracy, completeness, or currency of any of the information published in this document. SRP makes no representations or warranties regarding this document's compliance with any applicable statute, rule, or regulation.

Technical Specifications

Model	Output Wattage	Supply Voltage	Supply Phase	Supply Amp Draw	Supply Voltage / Connection	Dimensions	Weight	Support Mounting Detail A x B
EW30L20Y	3,000 W	208 V	3	8.3 A x 3	3Φ4W, 208Y/120Vac	73x10x3" (186x25x7.5 cm)	27.6 lbs (12.5 Kg)	47 x 3.8" (120x9.6cm)
EW30L24D	3,000 W	240 V	3	7.2 A x 3	3Φ3W, 240Vac Δ	73x10x3" (186x25x7.5 cm)	27.6 lbs (12.5 Kg)	47 x 3.8" (120x9.6cm)
EW45L24D	4,500 W	240 V	3	10.8 A x 3	3Φ3W, 240Vac Δ	96x10x3" (243x25x7.5 cm)	35.9 lbs (16.3 Kg)	70 x 3.8" (180x9.6cm)
EW45L48D	4,500 W	480 V	3	5.4 A x 3	3Φ3W, 480Vac Δ	96x10x3" (243x25x7.5 cm)	35.9 lbs (16.3 Kg)	70 x 3.8" (180x9.6cm)
EW45L48Y	4,500 W	480 V	3	5.4 A x 3	3Φ4W, 480Y/277Vac	96x10x3" (243x25x7.5 cm)	35.9 lbs (16.3 Kg)	70 x 3.8" (180x9.6cm)
EW45L60D	4,500 W	600 V	3	4.3 A x 3	3Φ3W, 600Vac Δ	96x10x3" (243x25x7.5 cm)	35.9 lbs (16.3 Kg)	70 x 3.8" (180x9.6cm)
EW45L60Y	4,500 W	600 V	3	4.3 A x 3	3Φ4W, 600Y/346Vac	96x10x3" (243x25x7.5 cm)	35.9 lbs (16.3 Kg)	70 x 3.8" (180x9.6cm)

EW30L48	3000 W	480 V	1	6.25A	1Φ2W, 480Vac	73x10x3" (186x25x9cm)	27.6 lbs (12.5 Kg)	47 x 3.8" (120x9.6cm)
EW30L60	3000 W	600 V	1	5A	1Φ2W, 600Vac	73x10x3" (186x25x9cm)	27.6 lbs (12.5 Kg)	47 x 3.8" (120x9.6cm)
EW45L48	4500 W	480 V	1	9.38A	1Φ2W, 480Vac	96x10x3" (243x25x9cm)	35.9 lbs (16.3 Kg)	70 x 3.8" (180x9.6cm)
EW45L60	4500 W	600 V	1	7.5A	1Φ2W, 600Vac	96x10x3" (243x25x9cm)	35.9 lbs (16.3 Kg)	70 x 3.8" (180x9.6cm)

EW15L12	1500 W	120 V	1	12.5A	1Φ2W, 120Vac	57x8x3" (145x20x8cm)	16.5 lbs (7.5 Kg)	47 x 3.8" (120x9.6cm)
EW32L24	3200 W	240 V	1	13.3A	1Φ2W, 240Vac	89x8x3" (226x20x8cm)	25.1 lbs (11.4 Kg)	70 x 3.8" (180x9.6cm)

EW18M12	1800 W	120 V	1	15A	1Φ2W, 120Vac	41x10x3" (105x25x9cm)	15.7 lbs (7.1 Kg)	33.5 x 3.8" (85x 9.6cm)
EW18M12V	1800 W	120 V	1	15A	1Φ2W, 120Vac	43x10x3" (110x25x9cm)	16.8 lbs (7.6 Kg)	33.5 x 3.8" (85x 9.6cm)
EW18M24	1800 W	240 V	1	7.5A	1Φ2W, 240Vac	41x10x3" (105x25x9cm)	15.7 lbs (7.1 Kg)	33.5 x 3.8" (85x 9.6cm)
EW18M24V	1800 W	240 V	1	7.5A	1Φ2W, 240Vac	43x10x3" (110x25x9cm)	16.8 lbs (7.6 Kg)	33.5 x 3.8" (85x 9.6cm)