

Unit Illustrated: MQFDV453NE2 Free Standing Direct Vent Stove – Natural Gas, F450FBL Door Front – Charcoal with Black Posts, MQ453SDBL Side Doors with Black Frame and Charcoal Panel, MQLOGF453 Log Set – Driftwood, MQ453RLH Herringbone Brick Liner.



VANTAGE

FREE STANDING DIRECT VENT GAS STOVE

 marquis  
COLLECTION

Model	FDV451NE2	FDV451LPE2	MQFDV453NE2	MQFDV453LPE2
Fuel	Natural	Propane	Natural	Propane
Gas Control	IPI	IPI	IPI	IPI
Input Max.	34,500 BTU	31,000 BTU	34,500 BTU	31,000 BTU
Input Min.	23,750 BTU	24,500 BTU	23,750 BTU	24,500 BTU
FE (P.4.1-15)	67.72%	74.06%	67.72%	74.06%
Glass	Single	Single	Three	Three

LINERS

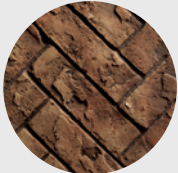

Herringbone  
Brick Liner



Traditional  
Brick Liner



Fluted  
Liner

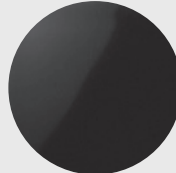

Porcelain  
Reflective Liner

LOG SETS



LOGF451  
Oak Log Set



MQLOGF452  
Oak Log Set



MQLOGF453  
Driftwood Log Set



F45LG Log  
Grate (Optional)

MEDIA OPTIONS

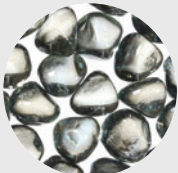

MQG5ZG  
Zircon Glacier  
Ice Glass



MQG5A  
Cobalt  
Ember Glass



MQG5B  
Black  
Ember Glass



MQG5C  
Bronze  
Ember Glass

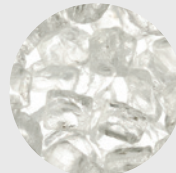

MQG5W  
White  
Ember Glass



MQEMBER  
Ember Chunks



MQSTONE  
Decorative  
Stones



MQROCK2  
Natural  
Rock Set



MQROCK3  
Multi-Colored  
Rock Set



RBCB1  
Multi-Colored  
Cannonballs

# Get the Best VANTAGE



## STANDARD FEATURES

- Proflame II Models include Remote Control – Features flame, fan, thermostat, smart thermostat (WIFI Compatibility\*)

\* Smartphone (local WIFI only)



- Dual burner system, with Realistic Flame Pattern
- Heat radiating ceramic glass
- Mobile home approved
- Charcoal with Black Accents
- Approved for installation in a bedroom or bed sitting room

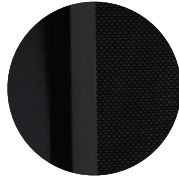

Charcoal with Black Accents

## OPTIONAL FEATURES

**Media:** Contemporary Rocks, Decorative Stones, Decorative Ember Glass (Glacier Ice, Cobalt Blue, Black, Bronze, White), Ember Chunks or Multi-Colored Cannonballs

**Log Sets:** Driftwood or Oak

**Log Grate:** F45LG – Black

**Liners:** Traditional, Herringbone or Black Fluted Refractory Brick Liner, or Porcelain Reflective Liner

**B-Vent Adapter:** Convert Stove to 4" B-Vent

Find all detailed Vantage manuals:



FDV451NE2 Free Standing Stove – Natural Gas, F450FBL Door Front – Charcoal with Black Posts, F451SDSBL Side Doors – Solid Charcoal Panel with Black Frame, MQG5C Bronze Glass (x3), MQROCK3 Rock Set – Multi-Colored, F451RLT Traditional Brick Liner.



FDV451NE2 Free Standing Direct Vent Stove – Natural Gas, F450FBL Door Front – Charcoal with Black Posts, F451SDSBL Side Doors – Solid Charcoal Panel with Black Frame, MQG5C Bronze Glass (x3), RBCB1 Cannonballs, F45LG Log Grate.



MQFDV453NE2 Free Standing Stove – Natural Gas, F450FBL Door Front – Charcoal with Black Posts, MQ453SDBL Side Doors with Black Frame and Charcoal Panel, MQG5C Bronze Glass (x3), MQSTONES Decorative Stones, MQ451RLH Herringbone Brick Liner.

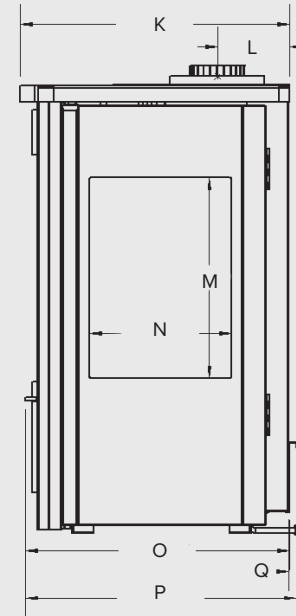
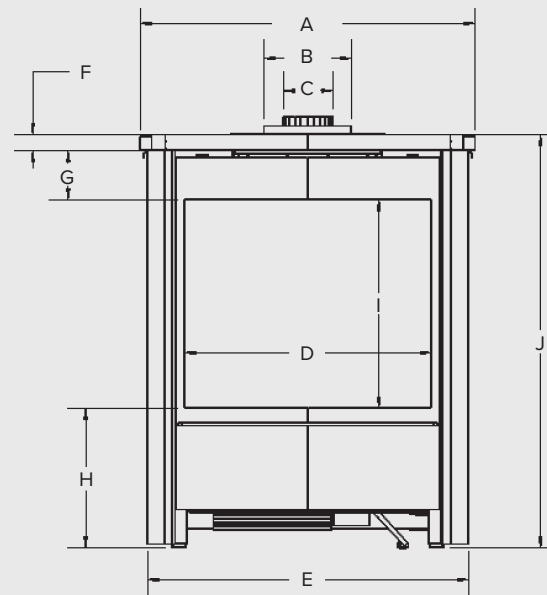

<b>A</b>	27 1/8"
<b>B</b>	7"
<b>C</b>	4"
<b>D</b>	20"
<b>E</b>	26"
<b>F</b>	1 1/4"
<b>G</b>	4"
<b>H</b>	11 5/16"
<b>I</b>	16 15/16"
<b>J</b>	33 1/2"
<b>K</b>	20 1/8"
<b>L</b>	5 3/8"
<b>M</b>	15"
<b>N</b>	10 5/8"
<b>O</b>	19 3/4"
<b>P</b>	20 5/16"
<b>Q</b>	9/16"

### MINIMUM CLEARANCES TO COMBUSTIBLES:

<b>36"</b>	from front of unit
<b>15 1/2"</b>	from side of unit
<b>2 1/2"</b>	from back of unit

### ALCOVE INSTALLATION:

<b>48"</b>	depth (max.)
<b>71 1/2"</b>	height (min.)
<b>58"</b>	width (min.)

Every angle gives you a beautiful view of the flames with the **Vantage** by Marquis. This contemporary take on a classic wood stove adds warmth with a sleek charcoal finish and flat black accents. Amp up the impact with your choice of log sets, decorative stones, rocks, and cannonballs or even ember glass.

Visit [www.marquisfireplaces.net](http://www.marquisfireplaces.net) to see the latest evolution in fireplaces.



**Unit Illustrated:** MQFDV453NE2 Free Standing Direct Vent Stove – Natural Gas, F450FBL Door Front – Charcoal with Black Posts, MQ453SDBL Side Doors - Black Frame and Charcoal Panel, MQG5C Bronze Glass (x3), MQ453PL Porcelain Liner.



Marquis Fireplaces maintains a program of continuous testing, refinement and improvements of all its products. Some aspect of units shown here may be changed at any time without notice or obligation.

Certification: FDV451N, FDV451NE, FDV451LP, FDV451LPE, MQFDV453N, MQFDV453NE, MQFDV453LP, MQFDV453LPE are Certified to: ANSI Z21.88-2017 - CSA 2.33-2017 Vented Gas Fireplace Heaters, CSA 2.17-2017.

\*Note: Components may have to be ordered separately to create a complete unit. Discuss with your local Marquis Dealer for clarification.



**FOR CALIFORNIA RESIDENTS ONLY:**  
**WARNING!** This product can expose you to chemicals including Carbon Monoxide, that is an externally vented by-product of fuel consumption, which is [are] known to the State of California to cause birth defects or other reproductive harm. For more information, visit [www.P65Warnings.ca.gov](http://www.P65Warnings.ca.gov).

Crafted entirely in Canada, each Marquis fireplace is built to the highest standards and made to last.

**LIMITED LIFETIME WARRANTY**



2340 Logan Avenue  
 Winnipeg, Manitoba, CAN  
 R2R 2V3  
 Phone: 204.632.1962  
 Fax: 204.632.1960  
[marquisfireplaces.net](http://marquisfireplaces.net)

Printed in Canada  
 B088 – 03/2023

Canada

**ENERGUIDE**

Look for the **EnerGuide**  
 Gas Fireplace Energy  
 Efficiency Rating in this brochure

Based on CSA P.4.1-15