



Unit Illustrated: MQRB4236NT Zero Clearance Direct Vent
Natural Gas Fireplace, HB42CVCK Designer Clean View
Circulating Kit, Decorated with White Ember Glass.

SKYLINE

ZERO CLEARANCE DIRECT VENT GAS FIREPLACE

 marquis
COLLECTION

ENJOY THE VIEW



Find all
detailed
Skyline
manuals:



There is nothing subtle about this SKYLINE.

Its pure sophistication makes a statement with wide-view appeal and flexibility. Choose from the rocks and driftwood, decorative stones or ember glass in a choice of colors for a sleek contemporary look.

Visit www.marquisfireplaces.net to see the latest evolution in fireplaces.



PF1

STANDARD FEATURES

- Millivolt or IPI valve system will operate during power failures with Hi/low heat and flame adjustment
- Glass media: Bronze (ZCVRB3622), White (MQRB4236)
- Safety Screen Barrier

OPTIONAL FEATURES

Designer Clean View Circulating Kit:

(MQRB4236 Model Only) No Louvers Required

Surround – Edge (ZCVRB3622 only)

Black or Stainless Steel (36"W x 22 1/2"H)

Surround – Flatt (ZCVRB3622 only)

Black (45 1/16"W x 34 5/8"H)

Fan Kit:

Heat activated with variable speed control

Universal Light Kit:

Two Lamps (Series II Models only)

Porcelain Reflective Liners

(For ZCVRB3622 Models only)

Driftwood Log Sets:

Four Pieces Driftwood with Four Rocks (MQRBD1) or Three Piece Driftwood Log Set (MQRBD4)

Media Options:

Contemporary Rocks, Decorative Stones, Decorative Ember Glass (Glacier Ice, Cobalt Blue, Black, Bronze, White) or Ember Chunks

Thermostat:

Wall Mount Thermostat or Programmable Thermostat

Remote Controls:

Thermostat, Thermostat Modulating

Unit Illustrated (left): ZCVRB3622N Zero Clearance Direct Vent Natural Gas Linear Fireplace, with Decorative Bronze Glass, ZCVRB365WFBFL Surround (Flatt – Black), Z3622PRL Porcelain Reflective Liner, and optional ULK2 Universal Light Kit.

SKYLINE PRODUCT SPECIFICATIONS

MODEL	ZCVRB3622N ZCVRB3622NE	ZCVRB3622LP ZCVRB3622LPE	MQRB4236NT MQRB4236NTE	MQRB4236LPT MQRB4236LPTE
Fuel	Natural	Propane	Natural	Propane
Input Max.	17,500	17,500	24,000	24,000
Input Min.	12,000	14,000	18,000	18,000
FE (P.4.1-15)	61.36% / 65.82%	62.72% / 64.55%	54.84% / 57.05%	57.15% / 59.13%

SKYLINE ACCESSORIES

SKYLINE PRODUCT DIMENSIONS

CLEAN VIEW FRAMING

CORNER FRAMING DIMENSIONS (INCHES)

ZCVRB3622

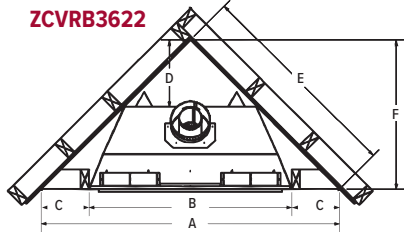

MQRB4236

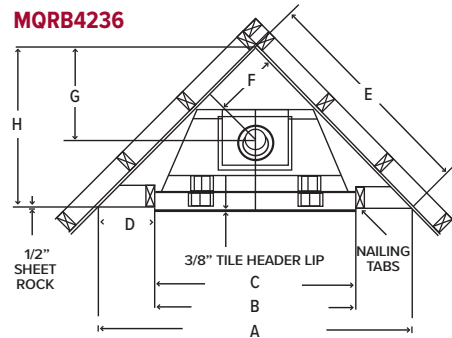

ZCVRB3622 MQRB4236

A	53 1/2"	A	63 13/16"
B	36 3/8"	B	42 7/16"
C	8 9/16"	C	42 1/16"
D	12"	D	10 11/16"
E	37 7/8"	E	45 1/8"
F	26 3/4"	F	13 3/4"
G	-	G	19 1/2"
H	-	H	31 7/8"

TOP FLUE MODEL VIEWING AREA

ZCVRB3622
MQRB4236

Height	Width
16 1/8"	29 3/4"
20 3/8"	33 3/8"

TOP FLUE MODEL DIMENSIONS

ZCVRB3622
MQRB4236

Height	Front Width		Depth	
	Actual	Framing	Actual	Framing
37 1/8"	37 1/4"	36"	36 3/8"	17 7/16"
36 13/16"	43"	42 1/16"	42 7/16"	18 15/16"



Unit Illustrated: ZCVRB3622N Zero Clearance Direct Vent Natural Gas Fireplace, Z3622PRL Porcelain Reflective Liners, MQRBD1 Contemporary Rock and Driftwood Set.



Unit Illustrated: ZCVRB3622N Zero Clearance Direct Vent Natural Gas Linear Fireplace, with Decorative Bronze Glass, ZCVRB36SSS Surround Edge (Stainless Steel), Z3622PRL Porcelain Reflective Liner, and optional ULK2 Universal Light Kit.

LOG SETS



MQRBD1
4 Piece
Driftwood Set
with 4 Rocks



MQRBD4
3 Piece
Driftwood Set

LINER

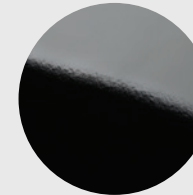

Porcelain
Reflective
(ZCVRB3622 Models Only)

SURROUNDS

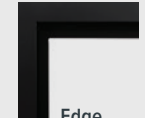

Edge
ZCVRB36SBL

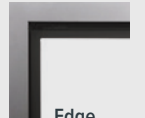

Edge
ZCVRB36SSS

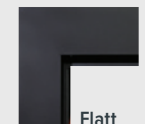

Flatt
ZCVRB36SWFBL

MEDIA OPTIONS



MQG5ZG
Zircon Glacier
Ice Glass

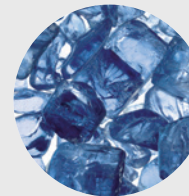

MQG5A
Cobalt
Ember Glass



MQG5B
Black
Ember Glass



MQG5C
Bronze
Ember Glass

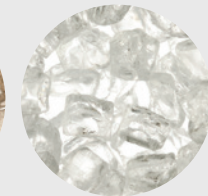

MQG5W
White
Ember Glass



MQEMBER
Ember
Chunks



MQSTONE
Decorative
Stones



MQRCK2
Natural
Rock Set



MQRCK3
Multi-Colored
Rock Set



Unit Illustrated: ZCVRB3622N Zero Clearance Direct Vent Natural Gas Fireplace, ZCVRB36SBL Surround Edge (Black), Z3622PRL Porcelain Reflective Liners, MQRBD1 Contemporary Rock and Driftwood Set.



Marquis Fireplaces maintains a program of continuous testing, refinement and improvements of all its products. Some aspect of units shown here may be changed at any time without notice or obligation.

Certification: These Models are certified to ANSI Z21.88-2017 CSA 2.33-2017 Vented Gas Fireplace Heaters.

Note: Components may have to be ordered separately to create a complete unit. Discuss with your local Marquis Dealer for clarification.

Canada

ENERGUIDE

Look for the **EnerGuide**
Gas Fireplace Energy
Efficiency Rating in this brochure

Based on CSA P.4.1-15



FOR CALIFORNIA RESIDENTS ONLY:
WARNING! This product can expose you to chemicals including Carbon Monoxide, that is an externally vented by-product of fuel consumption, which is [are] known to the State of California to cause birth defects or other reproductive harm. For more information, visit www.P65Warnings.ca.gov.

Crafted entirely in Canada, each Marquis fireplace is built to the highest standards and made to last.

LIMITED LIFETIME WARRANTY



2340 Logan Avenue
Winnipeg, Manitoba, CAN
R2R 2V3
Phone: 204.632.1962
Fax: 204.632.1960
marquisfireplaces.net

Printed in Canada
B093 - 07/2023