

MEMPHIS WI-FI SETUP GUIDE

ON YOUR MEMPHIS GRILL:

1. Register your account in the Memphis 3 app before proceeding.
2. Navigate to the Settings Screen (far right icon) on the Memphis Grill.
3. Press "WiFi" to navigate to the Connection Screen.
4. Press "Connect WiFi" to start WiFi setup. The screen will display "Visible on Bluetooth" to show it has started.

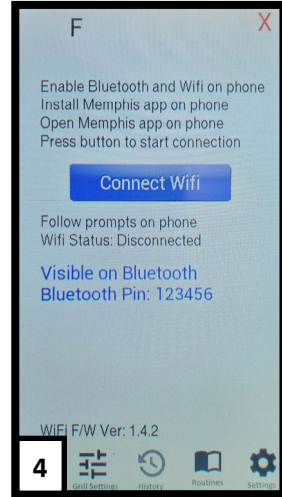
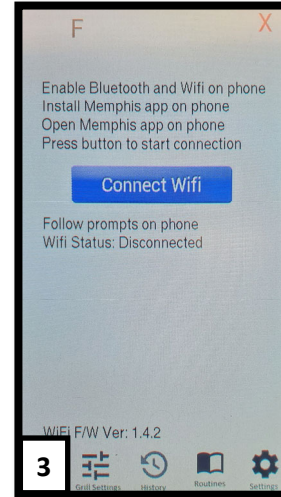

ON YOUR PHONE OR TABLET: (In Memphis 3 App)

6. Log into Memphis 3 App using your account email and password.
7. If this is your first time setting up a grill on the app, a window will pop up asking to "Provision Grill" or "Add Existing". Press "Provision Grill".
 - 7a. If this isn't the first grill being added to your account, select the settings gear in the top right corner and press "Add Grill" to get the popup.
8. Select your home WiFi network from the scan list shown, enter the WiFi password, and press "Provision".
 - 8a. The WiFi network must be a 2.4 GHz network to appear on the list
9. Enter the Bluetooth Pin to complete provisioning.
10. Once the connection is complete the Memphis Grill will display "Connection Successful" and update in WiFi screen information. The WiFi connection bars will also be displayed in the top right corner.
11. After the WiFi is connected, a popup window will appear in the Memphis 3 app asking for the MAC address and Grill Name. This information can be found on the WiFi screen of the Memphis Grill. Press Settings Menu (Bottom right icon) -> WiFi-> WiFi screen.

*Contact Memphis Technical Support if unable to connect.

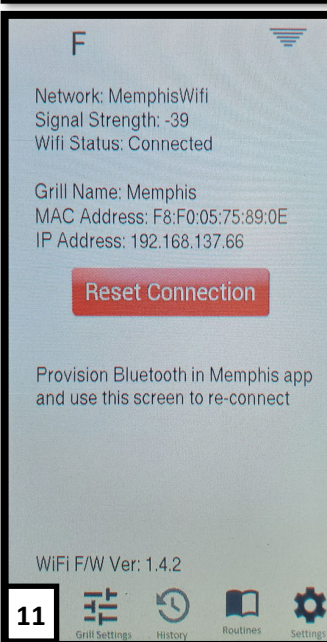
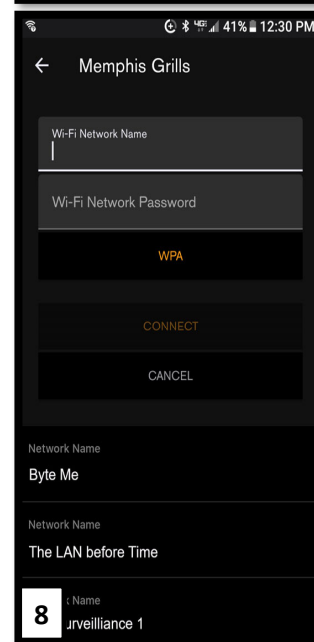
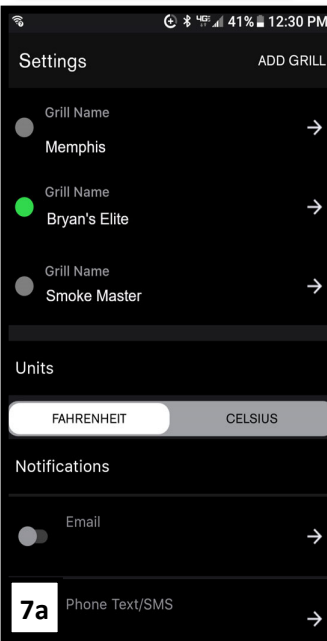
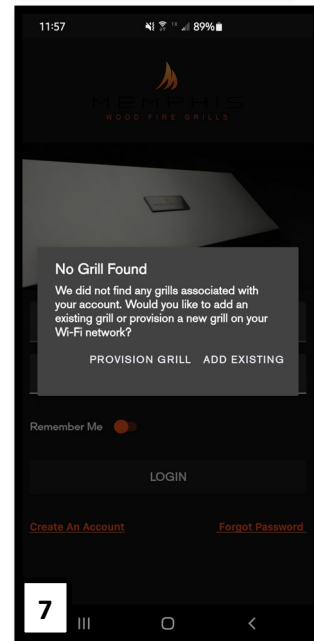

VG0896

Revision: B0



MEMPHIS
WOOD FIRE GRILLS

ELITE CART ITC 3 QUICKSTART GUIDE



TOOLS REQUIRED

- 3/8" Open End Wrench, Socket or Adjustable Wrench
- Phillips Screw Driver or Drill
- Snips or Heavy Duty Scissors
- Cut Resistant Gloves
- 5mm Allen Wrench

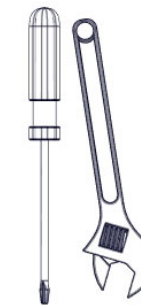

CONTENTS

- 1: Tools Required
- 2: Included Hardware
- 2-3: Assembly Instructions
- 4: Wi-Fi Setup and App Pairing

TIME REQUIRED

1.5 Hours

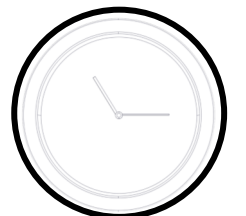

HARDWARE COMPONENTS MEMPHIS ELITE CART ASSEMBLY INSTRUCTIONS

Description/ Part No.	Qty:	Picture:
1. VG0002 Grate Kit	1	
2. Savorizer VGE4403	1	
3. Direct Flame Insert VG4407	1	
4. Genie Tool VG1595	1	
5. Shelf Bolt DS2311	10	
6. Antenna VG9023	1	
7. #10 Screw (SS) DS2186	2	
8. Cord Wrap VG0560	1	
9. Meat Probe VG0956	1	

1: Remove both shelves, the hardware kit, Savorizer, and grate kit from the grill. The shelves are located in boxes underneath the grill. The Savorizer and grate kit are in the grill hood. To remove the Savorizer, cut the 4 zip ties holding it in place.

Remove all laser film on the grill. This is a peel-able plastic left on to protect your grill from scratches during manufacturing and transit. Remove all laser film and laser etch lines with WD40 or olive oil. Once a grill has been heated up it is very difficult to remove this film, be sure to check your grill thoroughly before first burn.

2: Replace the Savorizer and place 3 large grates on the lower level and the long grate on the upper level.

3: Remove the Direct Flame Insert and Genie Tool from the right side shelf.

4: Install 2 shelf bolt (#5) into the right side of the grill. Leave approximately 1/4" of the bolts sticking out so that the shelf can slide onto them.

NOTE: ALWAYS HOLD SHELVES FROM THE BOTTOM AS THE SHELF TOP SLIDES OPEN!

5: Slide the shelf onto the bolts, press down on the shelf to secure into the keyway. Install the remaining 3 shelf bolts. Tighten bolts using 3/8" wrench, socket, or adjustable wrench.

6: Repeat steps 5 and 6 for the left side of the grill.

7: Remove two 5mm socket head screws from Display Housing shipping bracket using the 5mm allen wrench.

8: Snip the zip tie that secures the Display Housing to the shipping bracket.

9: Mount the Display Housing perpendicular to the side panel over the Display Insert bracket using the two 5mm x 50mm socket head screws in the hardware kit.

10: Attach the included antenna to the grill by twisting in a clockwise motion. The antenna will be included in the hardware kit located in the grease tray.

11: Attach the cord wrap with included screws found in the hardware kit.

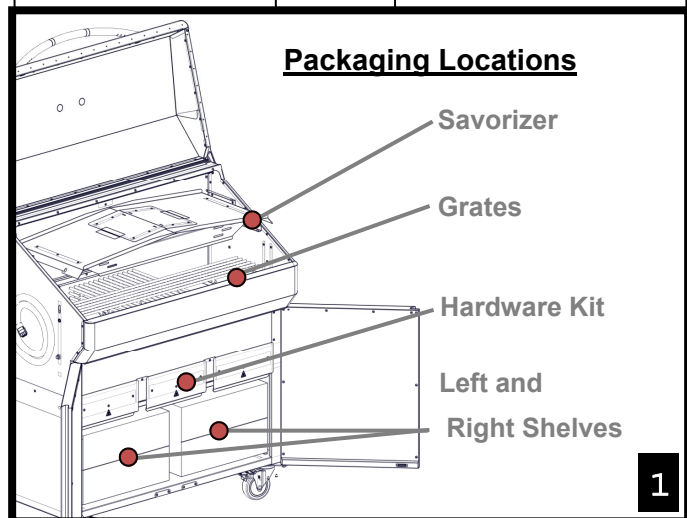

COMPLETE THE STEPS BELOW IN NUMERICAL ORDER, REFERENCE THE SAME NUMBERED DIAGRAM AND HARDWARE COMPONENTS FOR CLARIFICATION.

