



INSTALLATION AND OPERATION INSTRUCTIONS FOR

102745-DE

102755-DE

102765-DE

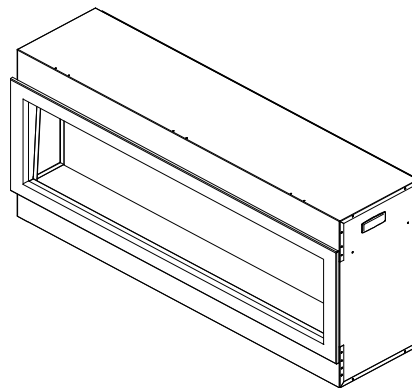

SAFETY INFORMATION



WARNING

If the information in these instructions are not followed exactly, a fire or explosion may result causing property damage, personal injury or loss of life.

Do not store or use gasoline or other flammable vapors and liquids in the vicinity of this or any other appliance.

INSTALLER: LEAVE THIS MANUAL WITH THE APPLIANCE.

CONSUMER: RETAIN THIS MANUAL FOR FUTURE REFERENCE.

TABLE OF CONTENTS

Please read and carefully follow all of the instruction found in this manual. Please pay special attention to the safety instructions provided in this manual. The instructions included here will assure that you have many years of dependable and enjoyable service from your Remii product.

IMPORTANT INSTRUCTIONS.....	3
UNPACKING AND TESTING APPLIANCE	4
GROUNDING APPLIANCE	4
LOCATING THE FIREPLACE	4
102745-DE	5
102755-DE	6
102765-DE	7
SAFETY DRILL SCREW AREA	8
HARD-WIRE INSTALLATION	8
FOR BATHROOM USE	9
OUTDOOR INSTALLATIONS.....	10
INSTALLTION.....	11
PROTECTIVE COVER INSTALLATION.....	16
MEDIA OPTIONS	17
OPERATION	19
INSTALLING WALL THERMOSTAT.....	21
REPLACEMENT PARTS	22
EXPLODED VIEW	23
TROUBLE SHOOTING.....	24
SERVICE HISTORY.....	25
WARRANTY.....	26

IMPORTANT INSTRUCTIONS

1. Read all instructions before installing or using this heater.
2. Keep combustible materials, such as furniture, pillows, bedding, papers, clothes and curtains at least 3 feet from the front of the heater; keep them away from sides and rear as well.
3. Always unplug heater when it's not in use.
4. Do not operate the fireplace if it has a damaged cord or plug, after it has malfunctioned, or if the unit has been dropped or damaged in any way.
5. Never place the heater where it may fall into a bathtub or other water containers.
6. Do not run the cord under carpeting. Do not cover the cord with throw rugs, runners or anything else. Arrange the cord away from traffic areas where it could not be tripped over.
7. To disconnect the heater, turn the controls to "OFF" before removing the plug from the outlet.
8. Do not insert or allow foreign objects to enter any ventilation or exhaust opening, as this may cause an electric shock, fire or damage to the heater.
9. To prevent a possible fire, do not block air intakes in any manner.
10. A heater has hot and arcing or sparking parts inside. Do not use it in areas where gasoline, paint or flammable liquids are used or stored.
11. Use this heater only as described in this manual. Any other use not recommended by the manufacturer may cause fire, electric shock or injury to persons.
12. Avoid the use of an extension cord because the extension cord may overheat and cause a fire.
13. Always use properly grounded fused and polarized outlets.
14. Always use ground fault protection where it is required by electrical codes.
15. Always disconnect the power before performing any cleaning, maintenance or relocation of the heater.
16. To prevent a possible fire, do not burn wood or other materials in this heater.
17. To prevent electric shock or fire, always use a certified electrician, should new circuits or outlets be required.
18. When transporting or storing the heater, keep it in a dry place, free from excessive vibration.

UNPACKING AND TESTING APPLIANCE

Carefully remove the appliance from the box. Prior to installing the appliance, test to make sure the appliance operates properly by plugging the power supply cord into a conveniently located 120 Volt grounded outlet.

GROUNDING APPLIANCE

This appliance is for use on 120 Volts. The cord has a plug as shown in (A). An adapter as shown in (C) is available for connecting three-blade grounding type plugs to two-slot receptacles. The green grounding lug extending from the adapter must be connected to a permanent ground such as a properly grounded outlet box. The adapter should not be used if a three-slot grounded receptacle is available.

To disconnect appliance, turn controls to off, then remove plug from outlet.

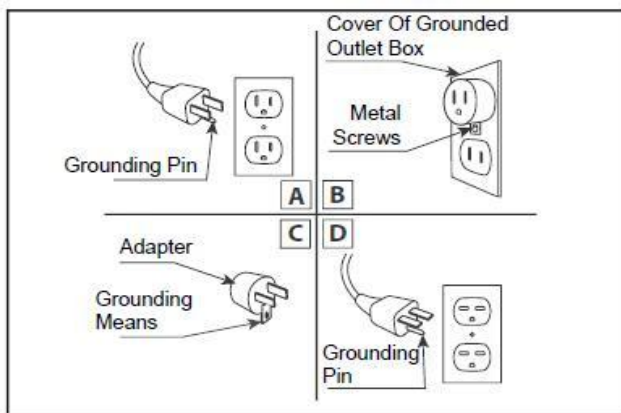

LOCATING THE FIREPLACE

Plan where to locate and frame the fireplace. This will save time and money later when you install the fireplace. Before installation consider the following:

1. Where the fireplace is located must allow for wall and ceiling clearances (see INSTALLATION)
2. Consider a location where the fireplace screen will not be exposed to direct sunlight from windows or doors.
3. A 15 ampere, 120 Volt, 60 Hz branch circuit with proper ground must be available at the location. Preferably a dedicated branch circuit should be provided to avoid circuit breakers to trip or fuses to blow.

102745-DE

Model Number	Built-in Appliance
Voltage	120V AC 60Hz
Watts	1500W Max
NO HEATER	25W
MOTOR HEATER	19W
Appliance Width	44 1/8" or 112.2 cm
Appliance Height	23 5/8" or 60 cm
Appliance Depth	11 7/8" or 30.2 cm
Gross Weight	103.6lbs or 47kgs
Plug Location	Left side
Cord Length	70 7/8" or 180 cm
Rough Wall Opening Size	45" x 25" or 114.3 cm x 63.5cm
BTU	4800

This appliance has been tested in accordance with the UL Standard 2021 for fixed and location dedicated electric room appliances in the United States and Canada. If you need assistance during installation, please contact your local dealer.

NOTE: This appliance must be electrically wired and grounded in accordance with local codes. In the absence of local codes, use the current CSA C22.1 Canadian Electrical Code in Canada or the ANSI/NFPA 70 National Electrical Code in the United States.

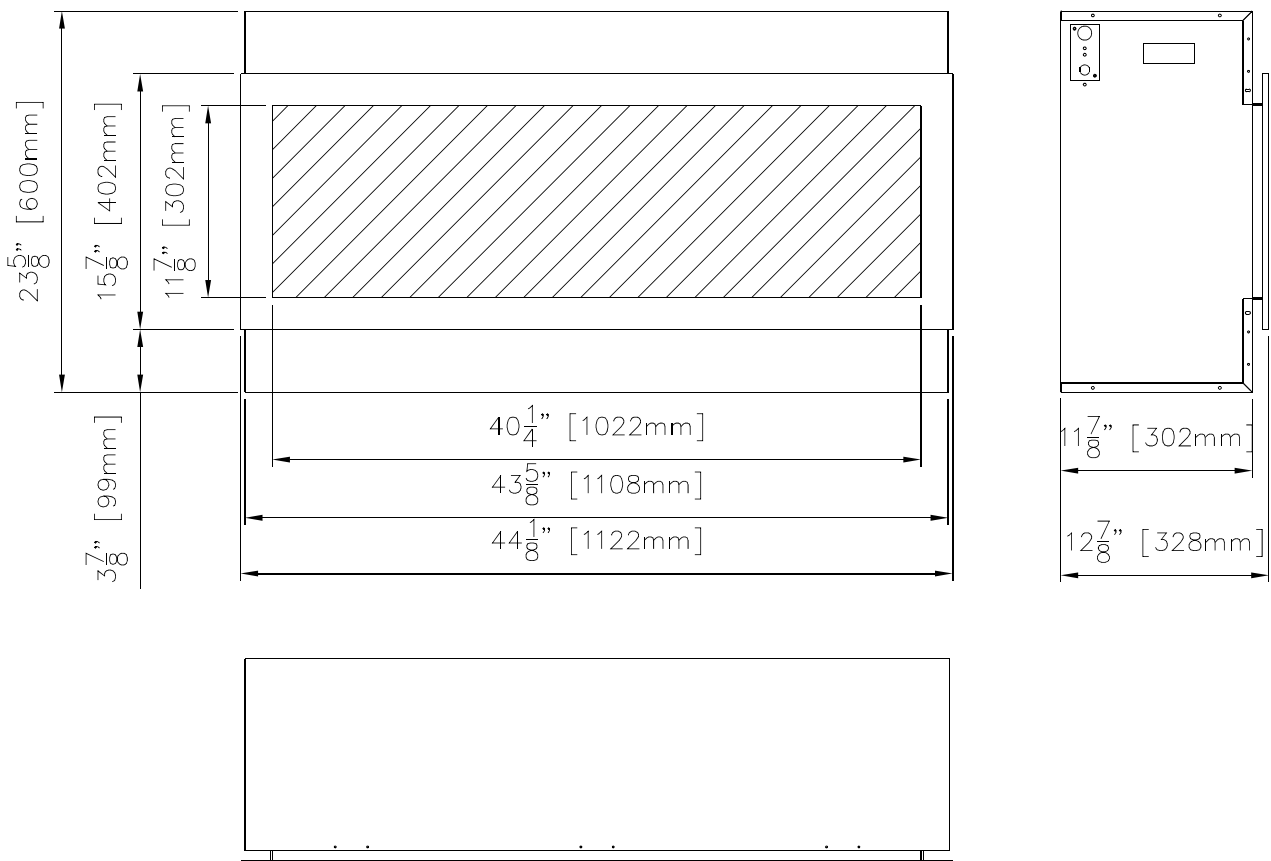

102755-DE

Model Number	Built-in Appliance
Voltage	120V AC 60Hz
Watts	1500W Max
NO HEATER	25W
MOTOR HEATER	19W
Appliance Width	54 1/8" or 137.6 cm
Appliance Height	23 5/8" or 60 cm
Appliance Depth	11 7/8" or 30.2 cm
Gross Weight	121lbs or 55kgs
Plug Location	Left side
Cord Length	70 7/8" or 180 cm
Rough Wall Opening Size	55" x 25" or 140 cm x 63.5 cm
BTU	4800

This appliance has been tested in accordance with the UL Standard 2021 for fixed and location dedicated electric room appliances in the United States and Canada. If you need assistance during installation, please contact your local dealer.

NOTE: This appliance must be electrically wired and grounded in accordance with local codes. In the absence of local codes, use the current CSA C22.1 Canadian Electrical Code in Canada or the ANSI/NFPA 70 National Electrical Code in the United States.

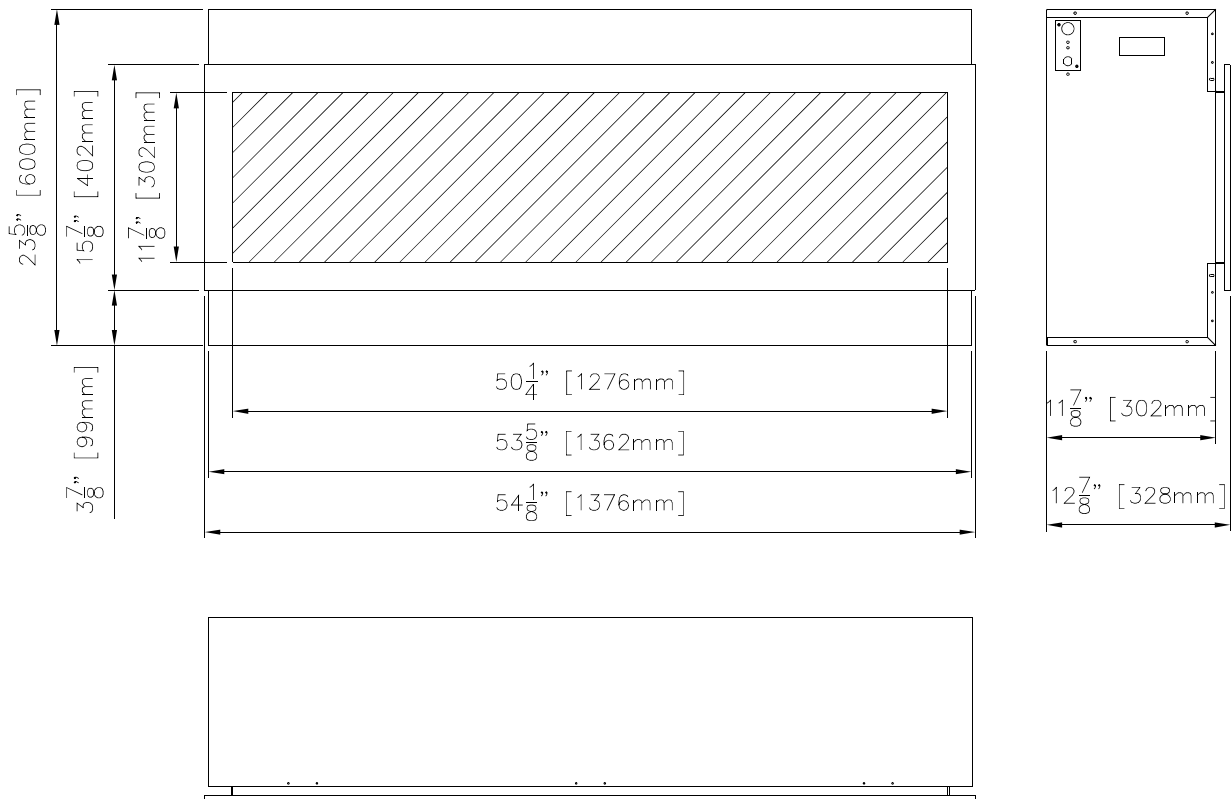

102765-DE

Model Number	Built-in Appliance
Voltage	120V AC 60Hz
Watts	1500W Max
NO HEATER	25W
MOTOR HEATER	19W
Appliance Width	64 1/8" or 163 cm
Appliance Height	23 5/8" or 60 cm
Appliance Depth	11 7/8" or 30.2 cm
Gross Weight	143lbs or 65kgs
Plug Location	Left side
Cord Length	70 7/8" or 180 cm
Rough Wall Opening Size	65" x 25" or 165 cm x 63.5 cm
BTU	4800

This appliance has been tested in accordance with the UL Standard 2021 for fixed and location dedicated electric room appliances in the United States and Canada. If you need assistance during installation, please contact your local dealer.

NOTE: This appliance must be electrically wired and grounded in accordance with local codes. In the absence of local codes, use the current CSA C22.1 Canadian Electrical Code in Canada or the ANSI/NFPA 70 National Electrical Code in the United States.

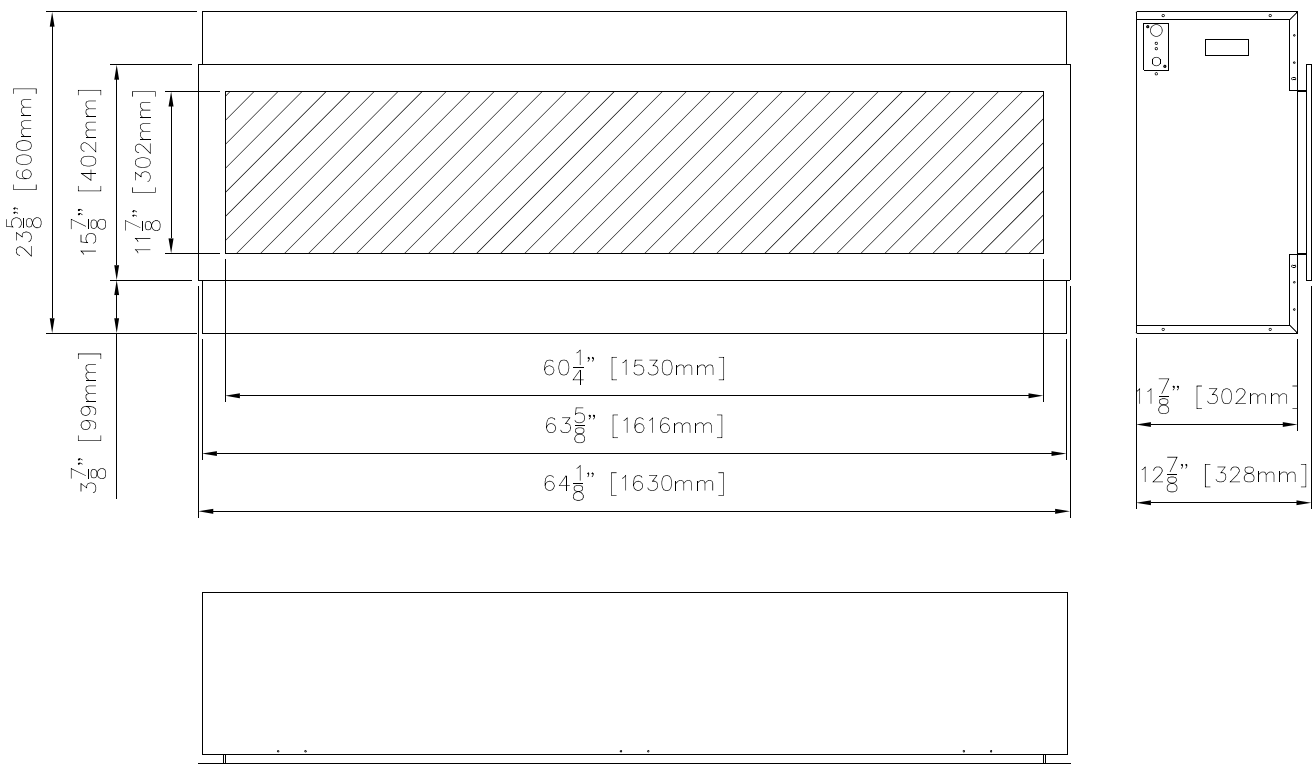

SAFETY DRILL SCREW AREA

There is a safety drill screw area as show below.
Please make sure that the fix screws are in this area.

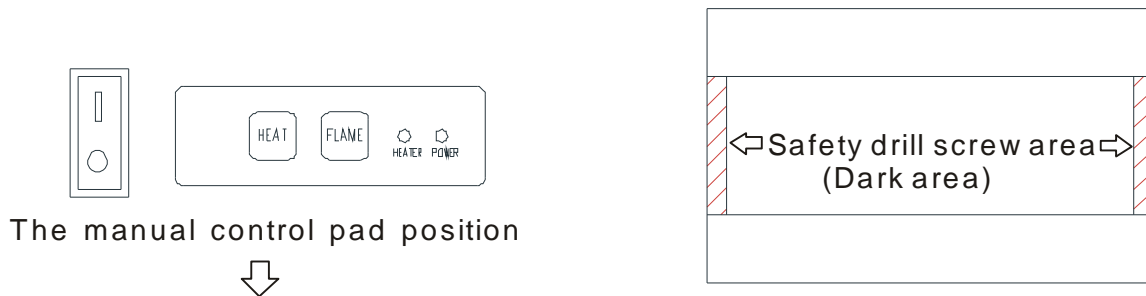

HARD- WIRE INSTALLATION

Turn off the appliance completely and let cool before servicing. Only a qualified service person should service and repair this electric appliance.

If it is necessary to hard wire this appliance, a qualified electrician must remove the cord connection, and wire the appliance directly to the household wiring.

This appliance must be electrically connected and grounded in accordance with local codes, if hard wired. In the absence of local codes, use the current CSA C22.1 CANADIAN ELECTRICAL CODE in Canada or the current ANSI/NFPA 70 NATIONAL ELECTRICAL CODE in the United States.

1. Remove the cover plate from the left side of the appliance by removing the two screws, as shown below. Unscrew and remove power cord.



2. Attach the wiring to the junction block. Please make sure the live wire goes into the “L”, the neutral wire into “N” and the ground wire into “G”.



3. Put the plate back and screw back.

FOR BATHROOM USE

If this unit is installed in a bathroom it must be protected by a GFI receptacle or circuit. If receptacle is used it must be readily accessible.

To prevent electric shock, please be aware that this unit is an electrical appliance that is *NOT* watertight and must be installed as to prevent water from entering unit. This must be installed away from showers, tubs, etc. Never locate fireplace where it may fall into a bathtub or other water container.

All wiring connections to line power shall be in accordance with local building code requirements. Inquires about local codes and regulations must be done prior to installation.

OUTDOOR INSTALLATIONS

The 102745-DE, 102755-DE and 102765-DE electric fireplaces are suitable for installation in outdoor areas protected from direct water impingement. In addition to maintaining the listed mantel and combustibles clearances, a rain protection overhang factor of 1/2 shall be constructed to the front and to each side of the installed appliance. See illustration below. All wiring connections to line power shall be in accordance with local building code requirements. 

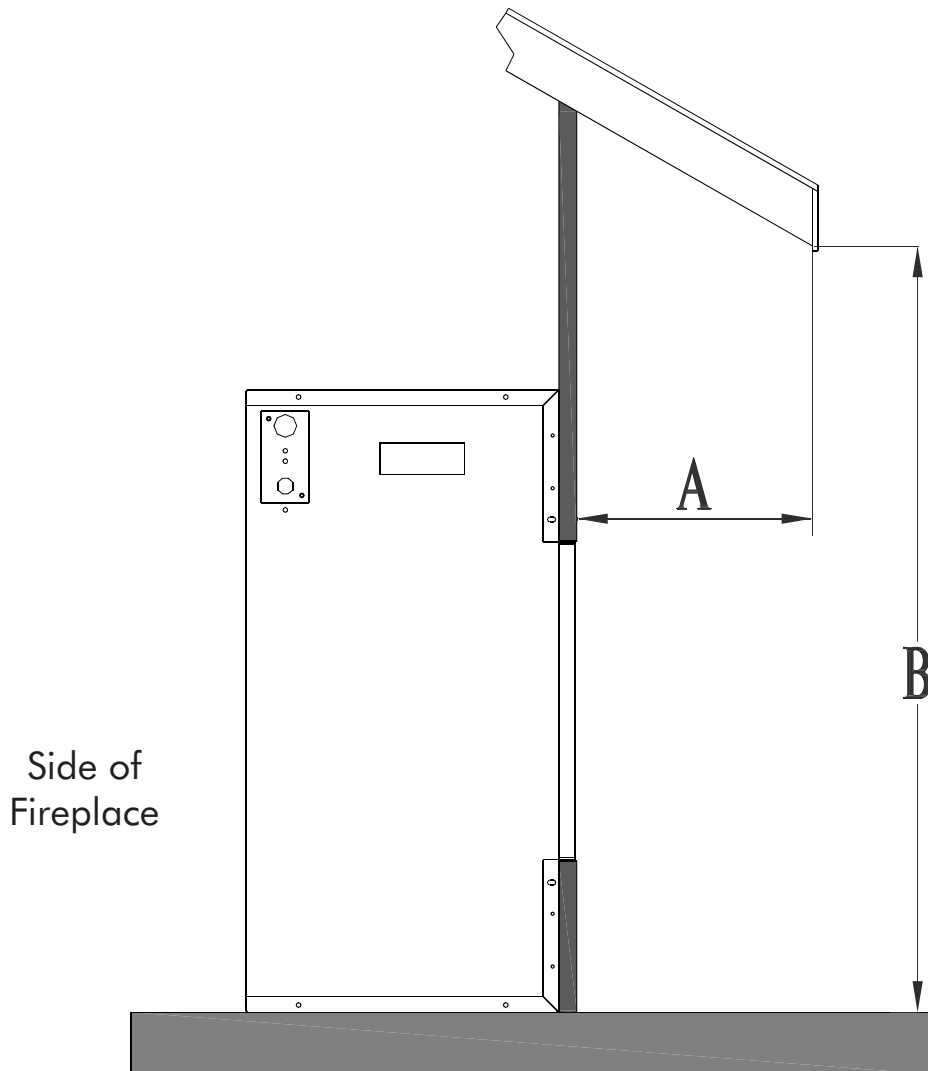

The overhang (A) must extend at least 1/2 the roof-line height (B). Height is measured from the base of the fireplace.

For example: if the roof-line (B) is 8' above the base of the fireplace, the overhang (A) must be at least 4'.

* When installed in outdoor applications, it is recommended that the 102745-DE, 102755-DE and 102765-DE use the protective covers: 45-COV, 55-COV and 65-COV.

INSTALLATION

The 102745-DE, 102755-DE and 102765-DE models are designed to be built-in. These units allow for the finishing material (drywall, stone, tile, etc) to be built right down to the glass edge. However, that application is not always desirable or available so the surround could be used as an alternate finish option.

Note: The optional surround is not firmly attached and can be removed from the unit by simply pulling it off. It is recommended that two people remove the surround.

The rough wall opening size of the fireplace:

	W(")	D(")	H(")
102745-DE	45	12	25
102755-DE	55	12	25
102765-DE	65	12	25

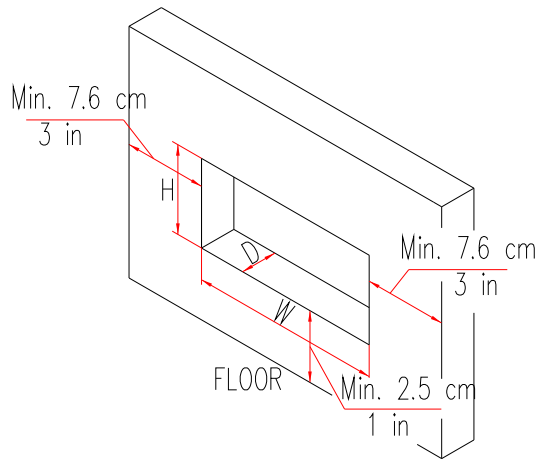

1. Take out the unit from the box. Please do the pre-test before you install the fireplace. Pull out the optional trim from the unit as shows below.

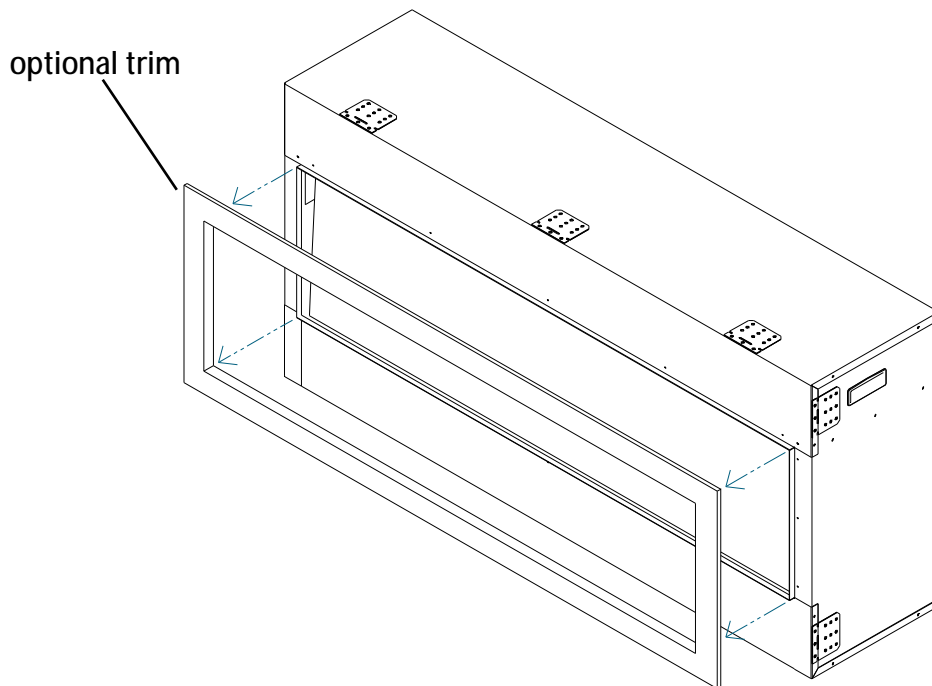

2. Remove the framing plates from the unit

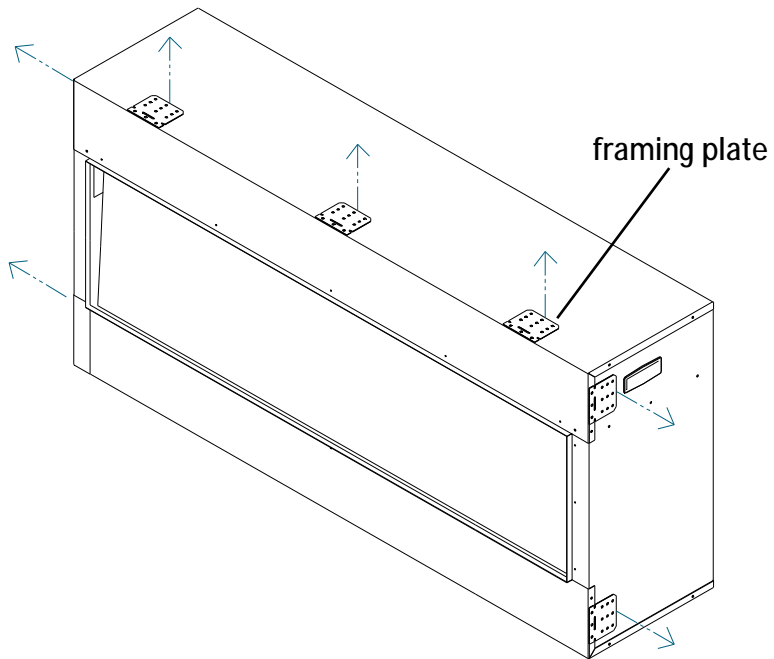

3. Re-fix the framing plates to the unit as the picture shows

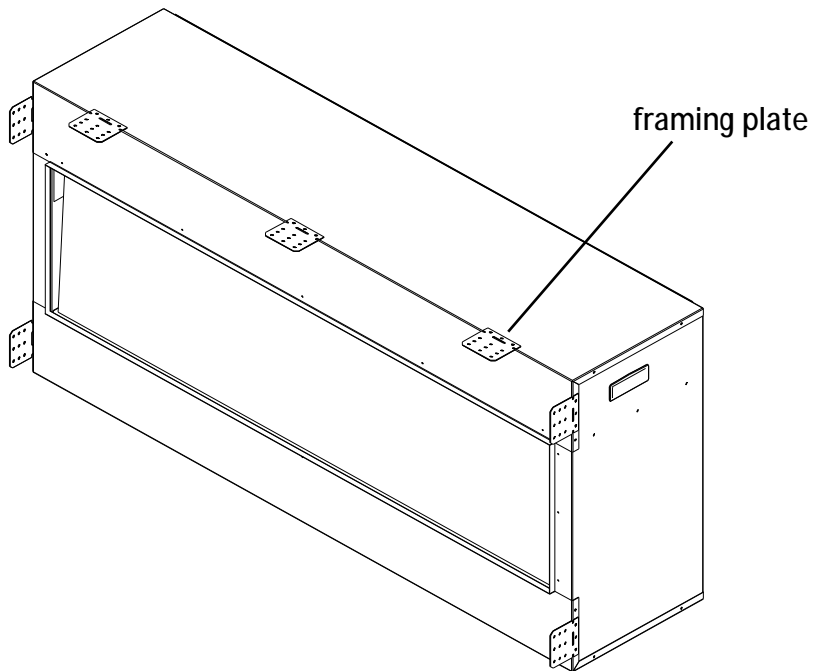

4. Bend up the framing plates.

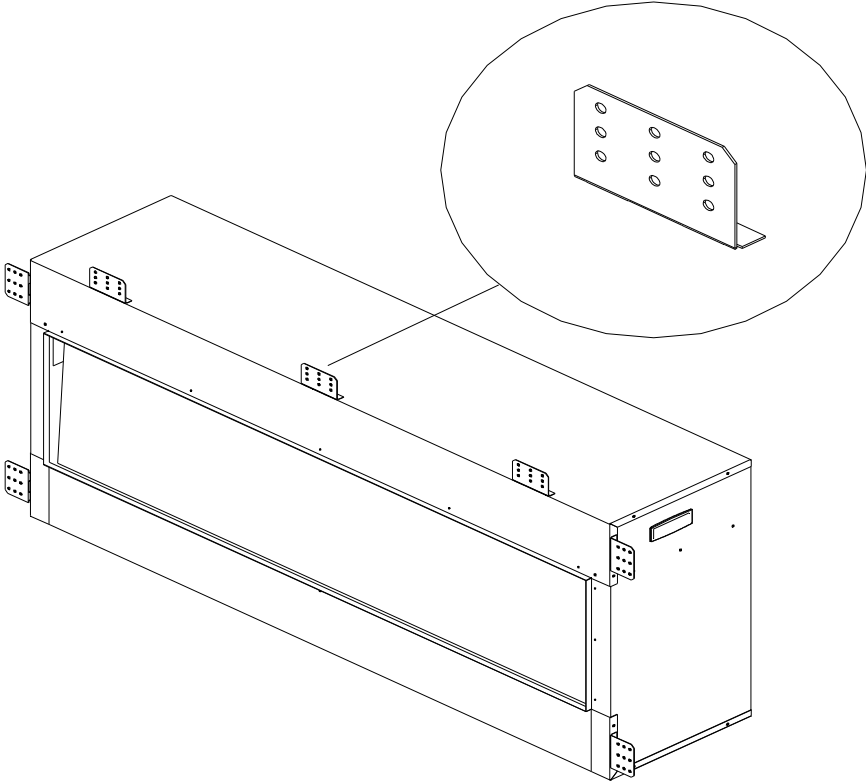

5. Put the unit into the opening.

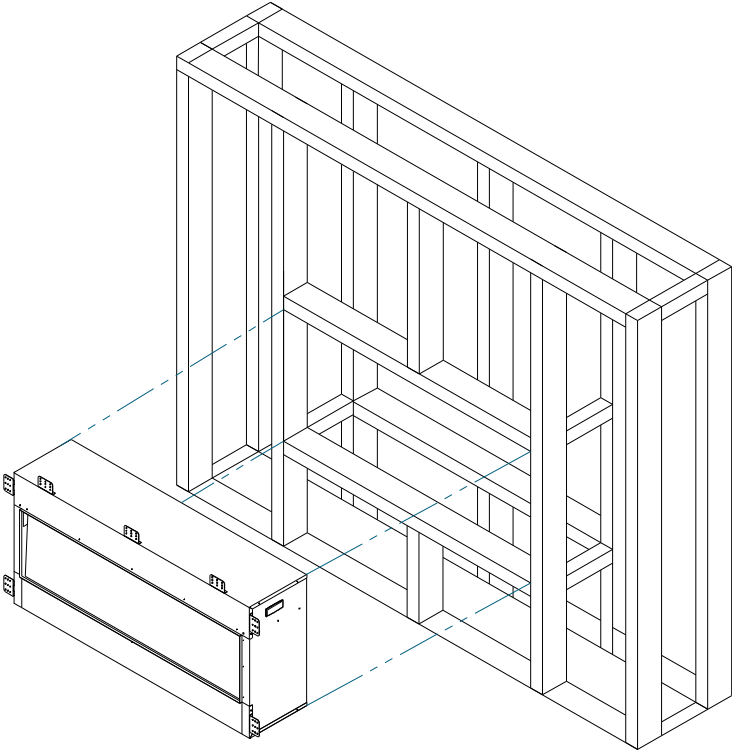

6. Drive the mounting screws into the framing plates on the unit and the wall studs.

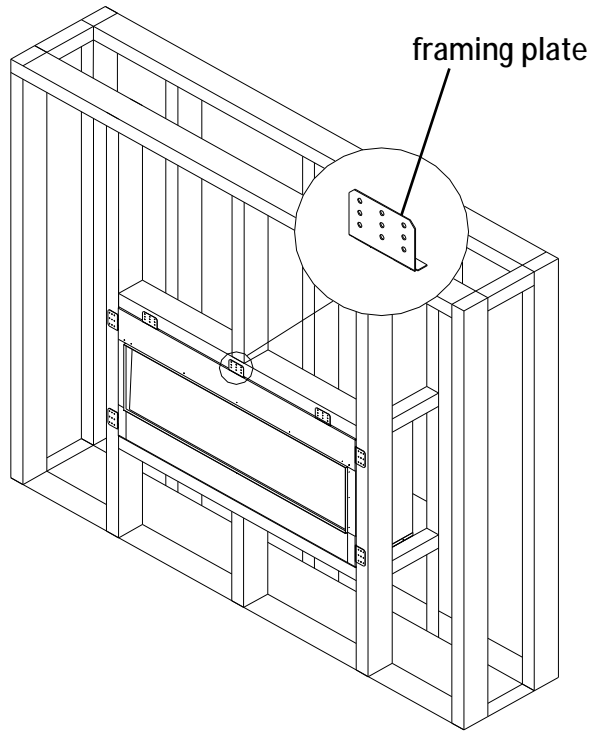

7. After checking that the fireplace operates properly, cover the glass panel with protective plastic bag and install polywood.

NOTE: IF YOU WANT TO USE THE TRIM KIT SUPPLIED that the thickness of the wall finish can only be 1 inch.

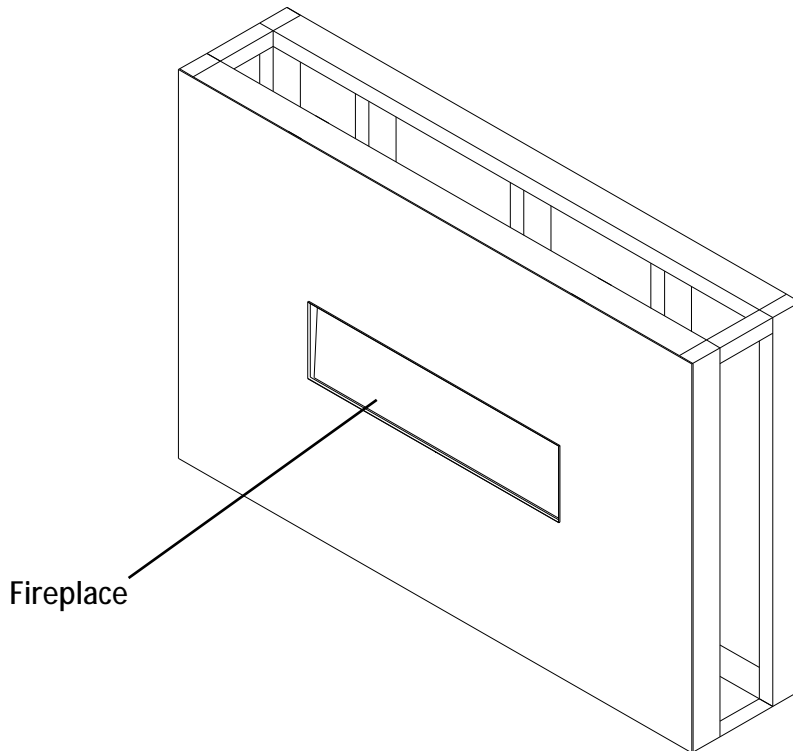

8. Decorate the polywood with glazed tile, wallpaper, etc.

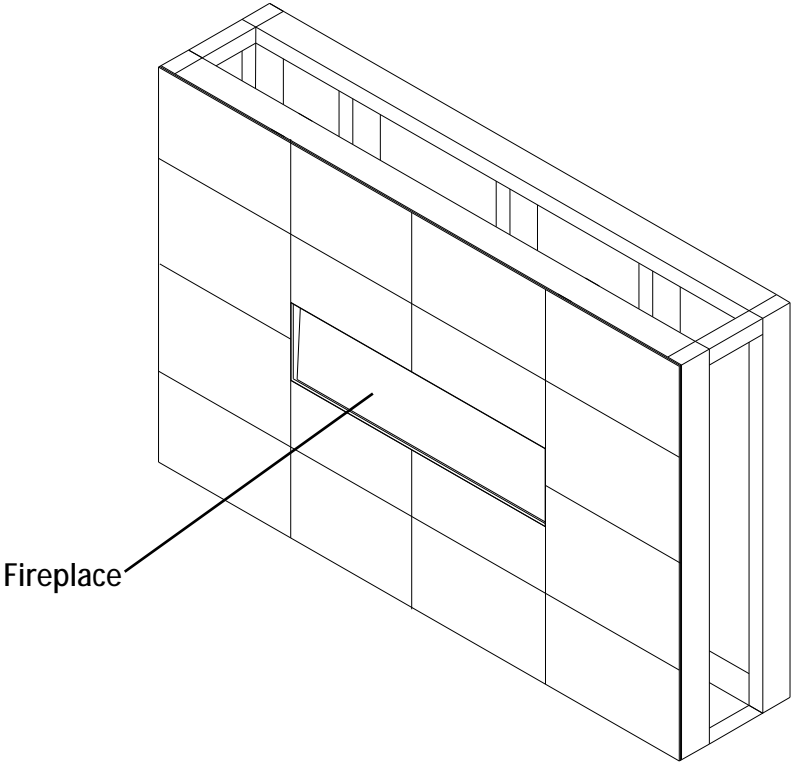

9. Put back the trim that you've removed from the unit at STEP 1.

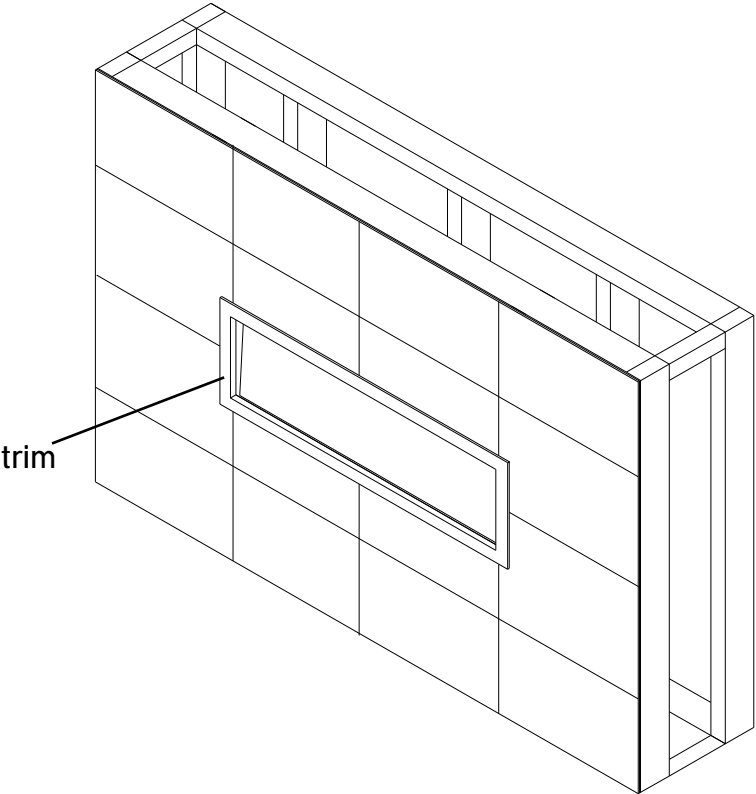

PROTECTIVE COVER INSTALLATION

Make sure install the protective cover when the fireplace used outdoors.
Remove the cover from the packaging.

The handles will need to be attached to the cover with the provided hardware as shown in fig. 1



Fig 1

First, place a plate washer and then a spring washer on the screw as shown in fig. 2



Fig 2

Affix the handles to the front of the cover using the prepared screws. Fig. 3



Fig 3



Fig 4

Insert the assembled cover onto the unit as shown in Figs. 4 and 5



Fig 5

Media Options

The 102745-DE, 102755-DE and 102765-DE are shipped with two mixture media shows below: the Canyon brown and Ocean blue. Consumers may purchase optional decorative media if they choose. See dealer for more details.



Canyon brown



Ocean blue

FIRE GLASS MEDIA-LOG INSTALLATION

1. Take off the front clear glass. There is a bracket that holds the front glass as shows below. Unscrew the screw to take off the bracket. Turn around the bracket and insert it into the gap to hook and pull out the glass.

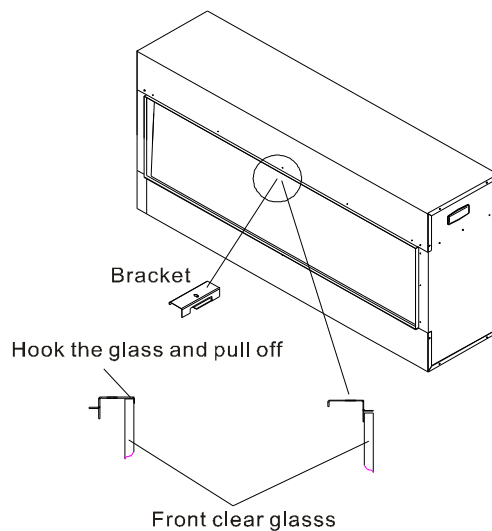

2. Install the fire glass media. Pour the fire glass media into the tray. Feel free to use any combination of fire glass media that you find most appealing.



3. Put back the front glass after you finish the fire glass decoration.

OPERATION

The fireplace can be operated either by the switches located on the left bottom of the fireplace unit or by supplied remote control.

Plug the fireplace into a 15 Amp wall socket.



MANUAL OPERATION



1. The main power ON/OFF switch in position O, the fireplace is OFF.
2. When main power ON/OFF switch is at position I, the fireplace is ready to use.
3. Press the  button repeatedly to set the heater to desired heat setting. The heater indicator LED will glow which shows the current heater settings.
 - a) RED 1500W HEAT OUTPUT
 - b) BLUE 750W HEAT OUTPUT
 - c) PURPLE AUTO MODE

AUTO MODE

Under this mode the heater will automatically turn ON at high heat setting 1500W heat output when the room temperature drops below 22°C (72°F). When the room temperature is between 22-25°C (72-77°F) the heater output will switch to low heat setting 750W. When the room temperature goes above 25°C (77°F) the heater will be turned off and the cycle will continue. The LED indicator will be PURPLE in colour under this mode.

4. Flame effect: Press the button marked  to adjust the flame brightness. The flame brightness will cycle through –Low-Medium-High -OFF.
5. Mood light effect: Press the button marked  to change the mood light colour.

NOTE: If operated at the Low heat setting, the fireplace will not provide as much heat output as in the High heat setting, however the low setting will not require as much electrical power to operate. To avoid overloading a circuit, do not plug the fireplace into a circuit that already has other appliances working. When the fireplace is not in use switch off and unplug.

SAFETY CUT-OFF

- ⌋ This appliance is fitted with a safety cut-off which will operate if the fireplace overheats (eg. Due to blocked air vents). For safety reasons, the fireplace will NOT automatically reset.
- ⌋ To reset the appliance, disconnect the appliance from the main supply for at least 10 minutes. Reconnect the supply to the main and switch on the appliance.

REMOTE CONTROL OPERATION

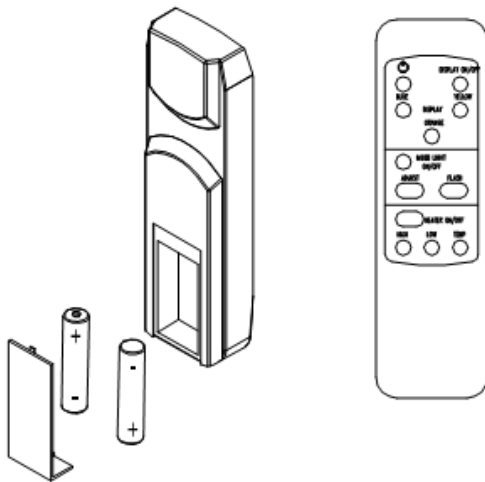

For remote to function make sure the heater is plugged in and main power switch located on the bottom left hand side is at position I.

When operating the remote make sure you point the remote to the centre of the fireplace and make sure each time you press the button the buzzer inside the unit will beep once. It takes some time for the receiver to respond to the transmitter. Do not PRESS the buttons more than once within two seconds for correct operation.

Power on  button: The power-on button at top left corner of the remote is the main ON/OFF power button. This will turn off all the functions and the fireplace will be in standby mode.

DISPLAY ON/OFF button: Switching the fireplace flame and tray light ON/OFF. It has functions of setting memory.

DISPLAY BLUE button: Adjust the blue color brightness of flame and tray.

DISPLAY YELLOW button: Adjust the yellow color brightness of flame and tray.

DISPLAY ORANGE button: Adjust the orange color brightness of flame and tray.

MOOD LIGHT ON/OFF button: Switching the mood light ON/OFF.

ADJUST button: Switching the color of the mood light.

FLASH button: Switches the mood light into flash mode, this cycles through all mood light colors.

HEATER ON/OFF button: Switching the heater ON/OFF. It has functions of setting memory.

HIGHT button: Press the high button to switch the heater to high heat setting 1500W.

LOW button: Press the low button to switch the heater to low heat setting 750W.

TEMP. button: Press the TEMP. button to switch the heater to AUTO mode. Under this mode the heater will operate in similar way as explained above for the manual operation.

INSTALLING WALL THERMOSTAT

WALL THERMOSTAT WIRING DIAGRAMS

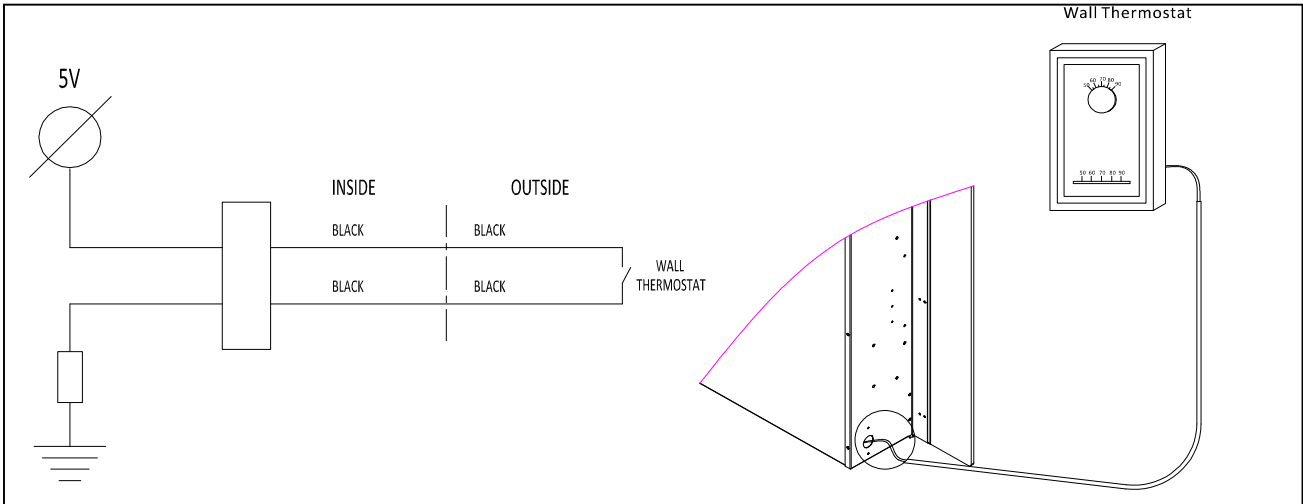

Wire the wall thermostat prior to installing the fireplace.

WALL THERMOSTAT WIRING(24 VAC)

Install Wall Thermostat per instructions provided with kit and per the following information:

1. Turn off circuit breaker.
2. Remove cover plate located on the left side of appliance.
3. Pull the wire out and cut the inside thermostat. Connect the wires to the wall thermostat as shown below. Follow instructions provided with wall switch kit.

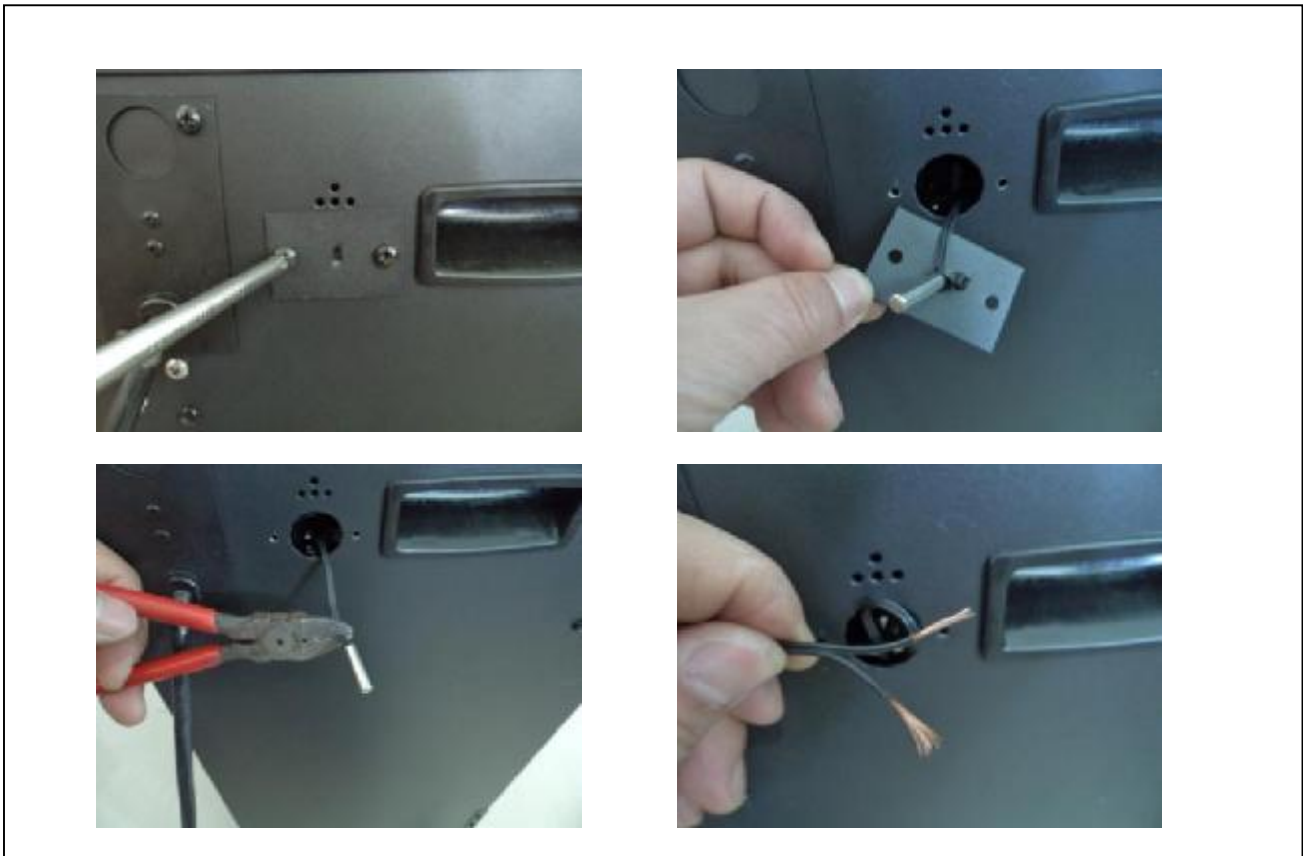

REPLACEMENT PARTS

This list contains replacement parts

NO.	PART NUMBER			DESCRIPTION	QTY
	102745-DE	102755-DE	102765-DE		
1	602030C			BLOWER AND HEATER ASSEMBLY	1
2				FIREPLACE BOX	1
3	10104010			SWITCH	1
4	601032B			CONTROL PANEL	1
5	601092C			CIRCUIT BOARD	1
6	10101225			FLAME MOTOR	2
7	3134504	3136504	3138504	FLICKER ASSEMBLY	
8	601136B			LED STRIP	4/6/8
	601137B				2/2/2
9	10203015			ADJUSTABLE FOOT	4
10	10701276	10701277	10701278	FLAME EFFECT GLASS WITH PLASTIC BOARD	1
11	3057012			GLASS BRACKET LH	1
12	3057013			GLASS BRACKET RH	
13	10702197	10702198	10702199	BOTTOM GLASS	1
15	3057016			FRONT GLASS BRACKET	1
17	10701273	10701274	10701275	FRONT GLASS	1
18	3134501	3136501	3138501	BLACK STEEL SURROUND	1
19	10125021	10125022	10125023	TOP LED STRIP	1
20	10105063			REMOTE	1

*19 and 20 not show in the picture.

EXPLODED VIEW

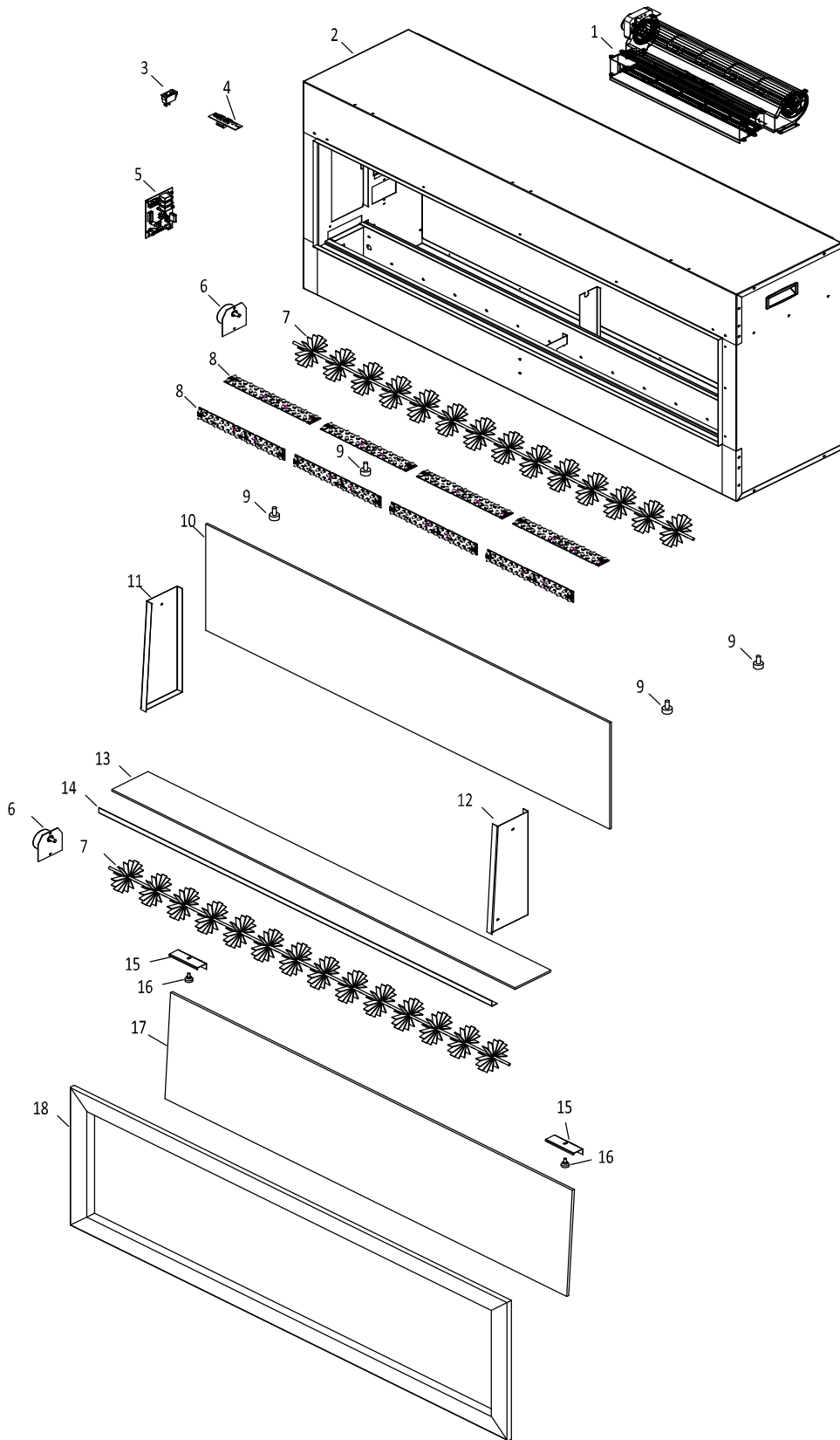

TROUBLE SHOOTING

PROBLEM	POSSIBLE CAUSE	SOLUTION
Dim or no flame	Flame LED's are burnt out	Inspect the LED's and replace them if necessary.
Ember bed is not glowing or dimming	Ember LED's are burnt out	Inspect the ember bed LED's and replace them if necessary.
Appliance turns off and will not turn on	Appliance has overheated and safety device has caused the thermal switch to disconnect	Turn off the main switch, allow appliance to cool for 10 minutes, then turn it on.
	House circuit breaker has tripped	Reset house circuit breaker.
	Appliance's fuse has blown	Replace the fuse.
Appliance will not come on when switch is flipped to ON	Appliance is not plugged into an electrical outlet	Check plug and plug in.
	Appliance has overheated and safety device has caused the thermal switch to disconnect	Turn off the main switch, allow appliance to cool for 10 minutes, then turn it on.
	Circuit board is burnt out	Inspect the circuit board and replace it if necessary.
No warm air coming out of appliance	Heater is burnt out	Inspect the burner and heater assembly and replace it if necessary.
Flame sputters	Flame motor is defective.	Call a qualified service technician and replace flame motor.
Remote Control does not work.	Low batteries. Unit switch in "O" position.	Replace AAA batteries in remote control. Turn the switch in "I" position.
Flame is fixed.	Wiring may be loose or the flame motor may be defective.	

SERVICE HISTORY

This heater must be serviced annually depending on usage.

Date	Dealer Name	Service Name technician	Service Performed	Special Concerns

NOTES:

WARRANTY

Remii Electric Fireplaces (“Remii”) warrants that your newly purchased Remii electric fireplace is free from manufacturing and material defects for a period of two (2) years from the date of the first purchase, subject to the conditions and limitations contained below.

Warranty Application & Exclusions

This limited warranty applies to your newly purchased Remii electric fireplace; the limited warranty's application is limited to purchases made in any province of Canada or in any of the 52 States of the United States of America, including the District of Columbia. Only the original purchaser of the product is eligible for coverage under this limited warranty; the warranty is not transferable.

Products excluded from this limited warranty

Light bulbs are not covered by this limited warranty and are the sole responsibility of the owner/purchaser. Remii does not cover service or labor charges.

Warranty Coverage and Term

Products covered by this limited warranty have been tested and inspected prior to shipment and, subject to the provisions of this warranty, Remii warrants such products to be free from defects in material and workmanship for a period of two (2) years from the date of the first purchase of such products.

The limited two (2) year warranty period for products also applies to any implied warranties that may exist under applicable law. Some jurisdictions do not allow limitations on how long an implied warranty lasts, so the above limitation may not apply to the purchaser.

All other warranties—expressed or implied—with respect to the product, its components and accessories or any obligation/liabilities on the part of Remii are hereby expressly excluded.

Limitations to Coverage Under Limited Warranty

This limited warranty does not apply to products that have been repaired, or otherwise altered. This limited warranty further does not apply to defects resulting from misuse, abuse, accident, neglect, incorrect installation, improper maintenance or handling, or operation with an incorrect power source. Products made by other manufacturers, sold with the product or thereafter, are not covered by this limited warranty. The use of unauthorized components will render this warranty null and void.

Outdoor Rated Units

All units that are installed outdoors or in moisture intense conditions must use the stainless steel cover/and or be installed with appropriate shelter. Proof of purchase of the cover and/or shelter is required for any warranty claims.

Defects

Defects must be brought to the attention of the selling dealer. Please have your proof of purchase, catalogue/model and serial numbers available when contacting dealer; any and all service under the limited warranty requires a proof of purchase of the product. Should a product or part covered by this limited warranty be proven to be defective, in material or workmanship, and during the two (2) year limited warranty period, Remii will replace such defective product or part without charge. If Remii is unable to replace such part, or if replacement is not commercially practicable or cannot be timely done, in its sole discretion Remii may, in lieu of replacement, choose to refund the purchase price for such product or part. Remii does not cover labor or service charges to replace said parts.

Limitations

In no event will Remii, including without limitation any of its directors, officers, shareholders, employees, consultants, agents, heirs, executors, administrators and assigns, be liable to the purchaser or any third party, whether in contract, in tort, or on any other basis for any indirect, special, punitive, exemplary, consequential, or incidental loss, cost or damage arising out of or in connection with the sale, maintenance, use or inability to use the product, even if Remii, including without limitation any of its directors, officers, shareholders, employees, consultants, agents, heirs, executors, administrators and assigns, have been advised of the possibility of such losses, costs or damages, or if such losses, costs or damages are foreseeable. In no event will Remii, including without limitation any of its directors, officers, shareholders, employees, consultants, agents, heirs, executors, administrators and assigns, be liable for any direct losses, costs or damages that exceed the purchase price of the product.

Some jurisdictions do not allow the exclusion or limitation of incidental or consequential damages, so the above limitation or exclusion may not apply to the purchaser.

Application of Provincial and State Law

This limited warranty gives you specific legal rights, and you may also have other rights which vary from jurisdiction to jurisdiction. The provisions of the United Nations Convention on Contracts for the Sale of Goods shall not apply to this limited warranty or the sale of products covered by this limited warranty.

General

Remii reserves the right to make changes at any time without notice, in design, material, specifications, prices and the right to discontinue styles and products.