

mantels, shelves & surrounds

BY FIRESIDE FINISHINGS

Design Series | Signature Series | Select Series



Fireside Finishings is the premier provider of hearth design solutions for finishing around wood, gas and electric fireplaces. With a broad selection of wood and non-combustible concrete mantels as well as stone selections, the details come together to transform a fireplace into a beautiful showpiece and your room into a reflection of your dreams, the way you live.

Mantels & Surrounds to Fit Any Style

DESIGN SERIES A distinctive selection of mantels, the Design Series is for those with an appreciation for design and craftsmanship who want to stay ahead of today's current trends.

SIGNATURE SERIES Timeless and superior in quality, the broad range of mantels in the Signature Series offers designs with something for every décor.

SELECT SERIES Offering an easy way to create a dramatic impact without dramatic cost, the Select Series is the perfect blend of quality, design and value.

Four steps to customizing your hearth

1. Choose your style

The Design, Signature and Select Series wood mantels and shelves are available in modern, transitional, traditional and rustic styles.

2. Pick your mantel or shelf

Choose from an impressive selection of mantel and shelf designs available in primed MDF, unfinished maple, unfinished distressed knotty alder wood or non-combustible concrete.

3. Match your surround

Stone selections frame your fireplace to ensure safety clearances are met, and to further enhance the beautiful fire.

4. Add the finishing touch

Fireside Finishings offers trend-right custom stain colors to elevate your look. Ask for a quote today.



Wood Species

All wood mantels and shelves by Fireside Finishings are available in paint-grade primed MDF. Select models are available in unfinished maple and distressed knotty alder.



UNFINISHED **MAPLE**



UNFINISHED **DISTRESSED KNOTTY ALDER**

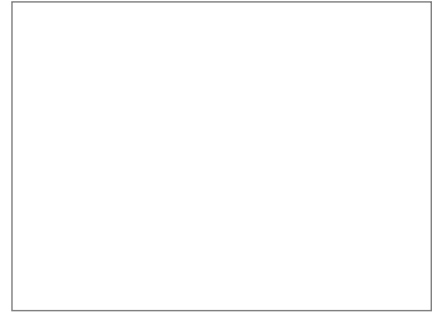

PRIMED **MDF**

Custom Stain Colors

Unfinished mantels are delivered ready to be finished with your choice of paint or stain, or can be stained before shipping. Your mantel provider can supply you with details on price and lead times of custom stain options.

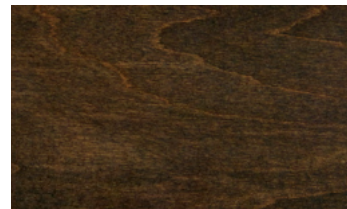

EBONY

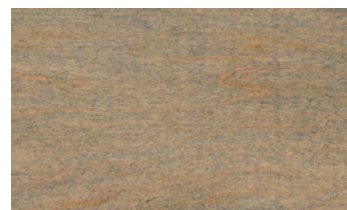

NEW GRAY



PROVINCIAL

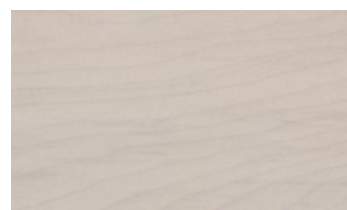

WHITEWASH



Left: Malone mantel with Bianco White marble. Cover: Malone mantel with Blue Tundra marble

Flush Wood Mantels

Capture your unique style by framing your fireplace with a well-crafted flush wood mantel coordinated with beautiful stone. Create a warm, welcoming space in your home that showcases your style.

MODERN designs flow naturally with crisp, clean lines and smooth surfaces, conveying a sense of simplicity from contemporary to minimalist to urban chic.

TRANSITIONAL designs are a sophisticated blend of old and new, creating a calming and relaxed space that manages to feel both stylish and sleek, as well as cozy and inviting.

TRADITIONAL designs bring back the memories of relaxing times around the fire and go with most any look, adding charm and natural beauty to your space.

RUSTIC designs highlight refreshing simplicity through natural beauty and rugged charm.





- TRADITIONAL STYLE
- SHOWN WITH BEIGE STONE

Available in Primed MDF



MALONE	B SIZE	C SIZE
A Opening Width	48"	53"
B Outside Width	65-3/4"	70"
C Opening Height	39-1/2"	42"
D Outside Height	54"	56-1/2"
E Top Width	74-3/4"	79"
F Leg Width	7-1/2"	7-1/2"
G Shelf Depth	9"	9"
H Leg Depth	5"	5"
Recommended Set Size	1	1

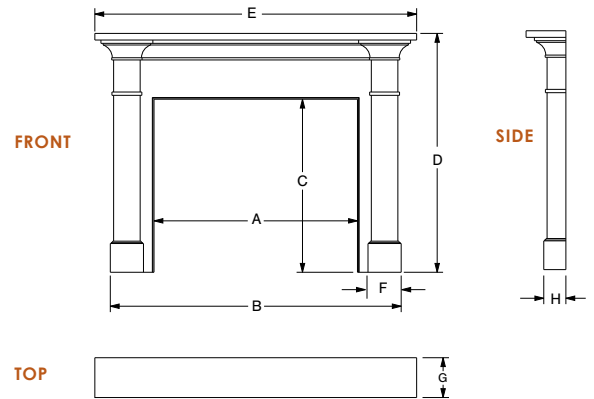

- RUSTIC STYLE
- SHOWN WITH ABSOLUTE BLACK GRANITE

Available in Primed MDF & Unfinished Distressed Knotty Alder

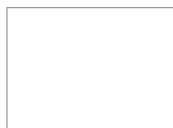

BATTLEFIELD	B SIZE	C SIZE
A Opening Width	48"	53"
B Outside Width	64"	69"
C Opening Height	39-1/2"	42"
D Outside Height	55-1/4"	57-3/4"
E Top Width	71"	76"
F Leg Width	6-1/2"	6-1/2"
G Outside Shelf Depth	7-3/4"	7-3/4"
H Leg Depth	5-1/2"	5-1/2"
Recommended Set Size	1	1

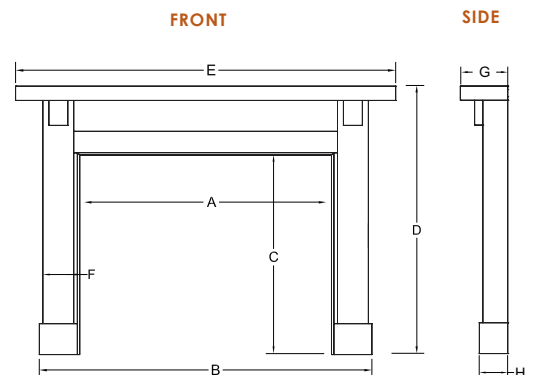



- TRANSITIONAL STYLE
- AVAILABLE WITH OR WITHOUT CORBELS
- UNFINISHED MAPLE TOP AVAILABLE IN EBONY, PROVINCIAL, NEW GRAY & WHITEWASH STAIN (SEE PAGE 3 FOR COLOR SWATCHES)
- SHOWN WITH BLUE TUNDRA MARBLE

Available in Primed MDF

Top available in unfinished maple



LAUREL	B SIZE	C SIZE
A Opening Width	48"	53"
B Outside Width	62-1/2"	67-1/2"
C Opening Height	39-1/2"	42"
D Outside Height	49-1/4"	51-3/4"
E Top Width	67"	72"
F Leg Width	6-3/4"	6-3/4"
G Shelf Depth	7-1/2"	7-1/2"
H Leg Depth	4-1/4"	4-1/4"
Recommended Set Size	1	1

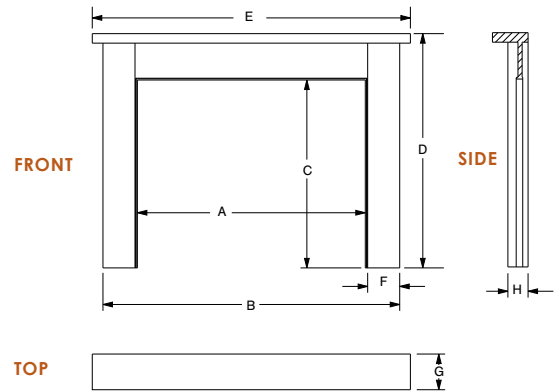

- MODERN STYLE
- TRUE SHELF TOP
- SHOWN WITH BIANCO WHITE MARBLE

Available in Primed MDF



WALKER	B SIZE	C SIZE
A Opening Width	48"	53"
B Outside Width	65"	70"
C Opening Height	39-1/2"	42"
D Outside Height	51-1/2"	54"
E Top Width	69-1/2"	74-1/2"
F Leg Width	8"	8"
G Shelf Depth	6-1/2"	6-1/2"
H Leg Depth	4-1/4"	4-1/4"
Recommended Set Size	1	1

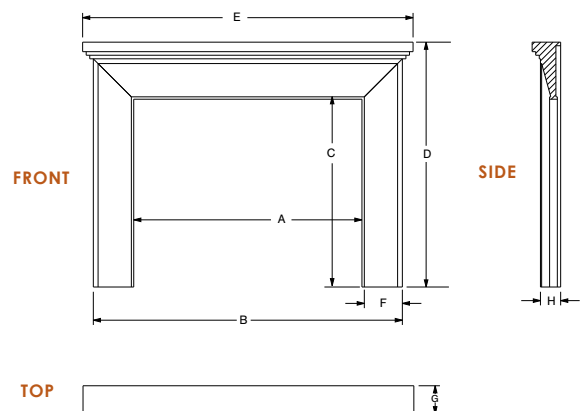

MERRITT | Signature Series



MERRITT	A SIZE	B SIZE	C SIZE
A Opening Width	44"	48"	53"
B Outside Width	58-1/2"	62-1/2"	67-1/2"
C Opening Height	36-1/2"	39-1/2"	42"
D Outside Height	46-1/4"	49-1/4"	51-3/4"
E Top Width	63"	67"	72"
F Leg Width	6-3/4"	6-3/4"	6-3/4"
G Shelf Depth	7-1/2"	7-1/2"	7-1/2"
H Leg Depth	4-1/4"	4-1/4"	4-1/4"
Recommended Set Size	2	1	1

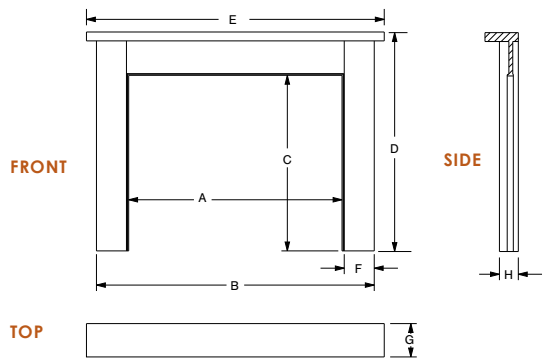

- TRANSITIONAL STYLE
- AVAILABLE WITH OR WITHOUT CORBELS
- SHOWN WITH PAULINE MARBLE

Available in Primed MDF

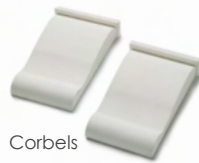

Corbels

ZIMMER | Signature Series



ZIMMER	A SIZE	B SIZE	C SIZE
A Opening Width	44"	48"	53"
B Outside Width	60"	65"	70"
C Opening Height	36.5"	39.5"	42"
D Outside Height	44.5"	48"	50-1/2"
E Top Width	60"	65"	70"
F Leg Width	7-1/2"	8"	8"
G Shelf Depth	4-1/4"	4-1/4"	4-1/4"
H Leg Depth	4-1/4"	4-1/4"	4-1/4"
Recommended Set Size	2	1	1

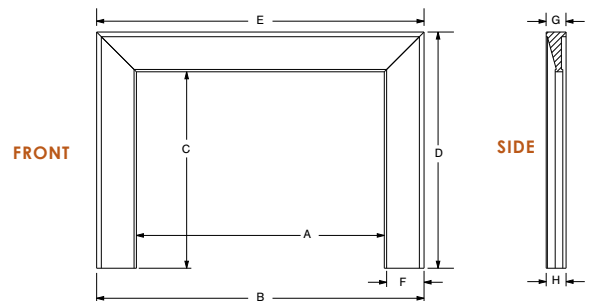

- MODERN STYLE
- SHOWN WITH STEEL GRAY GRANITE

Available in Primed MDF





KENWOOD (without base)	A SIZE	B SIZE	C SIZE	B60 SIZE
A Opening Width	44"	48"	53"	46"
B Outside Width	60"	65"	70"	60"
C Opening Height	36-1/2"	39-1/2"	42"	39-1/2"
D Outside Height	48-3/4"	51-3/4"	54-1/4"	51-5/8"
E Top Width	69-1/2"	74-1/2"	79-1/2"	67-1/2"
F Leg Width	8"	8"	8"	5"
G Shelf Depth	9-3/4"	9-3/4"	9-3/4"	8-1/2"
H Leg Depth	5"	5"	5"	4"
Recommended Set Size	2	1	1	2

OPTIONAL BASE	A SIZE	B SIZE	C SIZE
A Top Width	62-3/4"	69-1/2"	74"
B Bottom Width	63-3/4"	70-1/2"	75"
C Height	10"	10"	10"
D Top Depth	11-1/4"	11-1/4"	11-1/4"
E Bottom Depth	11-3/4"	11-3/4"	11-3/4"

- TRANSITIONAL STYLE
- SHOWN WITH BIANCO WHITE MARBLE

Available in Primed MDF & Unfinished Maple



FRONT

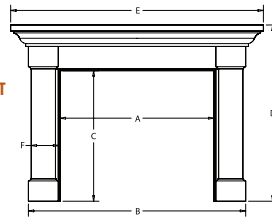

SIDE



BASE FRONT

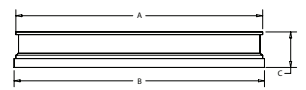

BASE SIDE



ROXBOROUGH	A SIZE	B SIZE	C SIZE
A Opening Width	44"	48"	53"
B Outside Width	56"	60"	65"
C Opening Height	36-1/2"	39-1/2"	42"
D Outside Height	49"	52"	54-1/2"
E Top Width	64"	68"	73"
F Leg Width	4"	4"	4"
G Shelf Depth	7-1/4"	7-1/4"	7-1/4"
H Leg Depth	3"	3"	3"
Recommended Set Size	2	2	1

- TRADITIONAL STYLE
- SHOWN WITH DRIFTWOOD MARBLE

Available in Primed MDF



FRONT

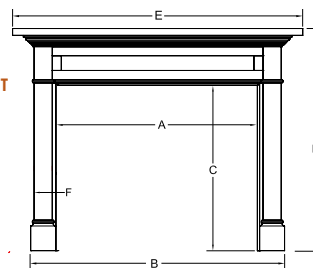

SIDE

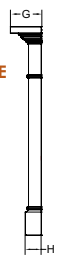



- TRADITIONAL STYLE
- SHOWN WITH ABSOLUTE BLACK GRANITE

Available in Primed MDF & Unfinished Maple



ACADIA	A SIZE	B SIZE	C SIZE
A Opening Width	44"	48"	53"
B Outside Width	61-1/2"	64"	69"
C Opening Height	36-1/2"	39-1/2"	42"
D Outside Height	49"	55-1/4"	57-3/4"
E Top Width	69"	71"	76"
F Leg Width	6-3/4"	6-1/2"	6-1/2"
G Outside Shelf Depth	7-1/2"	7-3/4"	7-3/4"
H Leg Depth	3-3/4"	3-3/4"	3-3/4"
Recommended Set Size	1	1	1

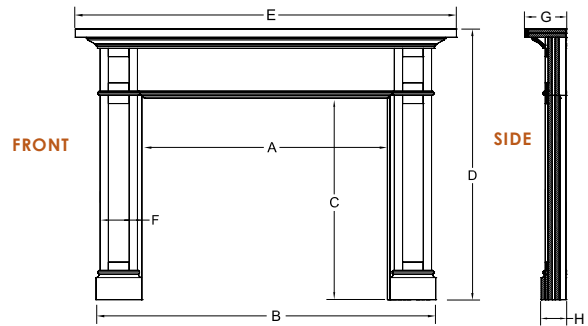

- TRANSITIONAL STYLE
- SHOWN WITH BLUE TUNDRA MARBLE

Available in Primed MDF



WESCOTT	A SIZE	B SIZE	C SIZE
A Opening Width	44"	48"	53"
B Outside Width	57"	60"	66"
C Opening Height	36-1/2"	39-1/2"	42"
D Outside Height	49-3/4"	52-3/4"	55-1/4"
E Top Width	63-3/4"	66-3/4"	72-1/2"
F Leg Width	6"	5-1/2"	6"
G Shelf Depth	7-1/2"	7-1/2"	7-1/2"
H Leg Depth	2-3/4"	2-3/4"	2-3/4"
Recommended Set Size	2	2	1

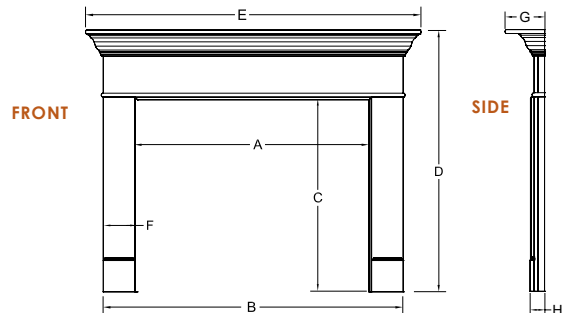



- TRANSITIONAL STYLE
- SHOWN WITH STEEL GRAY GRANITE

AVAILABLE IN

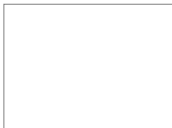

Primed MDF

RICHLAND	RS SIZE	A SIZE	B SIZE	C SIZE
A Opening Width	44"	44"	48"	53"
B Outside Width	55"	56"	60"	65"
C Opening Height	36-1/2"	36-1/2"	36-1/2"	42"
D Outside Height	48"	48"	51"	53-1/2"
E Top Width	60"	64"	68"	73"
F Leg Width	5"	5-1/2"	5-1/2"	5-1/2"
G Shelf Depth	7-1/2"	7-1/2"	7-1/2"	7-1/2"
H Leg Depth	2-3/4"	2-3/4"	2-3/4"	2-3/4"
Recommended Set Size	2	2	2	1

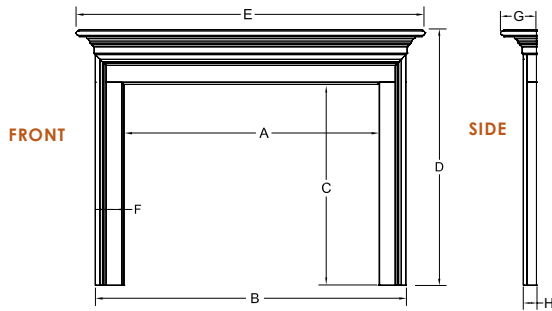

Laurel mantel with New Gray stain on top, Blue Tundra marble surround

Stone Surrounds

The timeless elegance of quality stone facings and hearths, from the world's finest quarries, are a perfect complement to your fireplace. Natural stone is beautiful, durable, and completely unique, reflecting your style whether modern or traditional. Select a stone that best fits your vision as the focal point of your room.

NATURALLY UNIQUE A broad range of patterns, hues, and texture makes each stone one-of-a-kind. Natural variations in stone coloring are expected, and some colors will vary more than others.

DESIGNED TO LAST As a natural material, stone is highly durable, scratch-resistant, and heat-tolerant.

VERSATILE Dark and light neutral colors pair well with all designs from modern to traditional. For double-sided fireplaces, consider selecting different stones and colors for each side to match each room's décor.

DESIGN SERIES

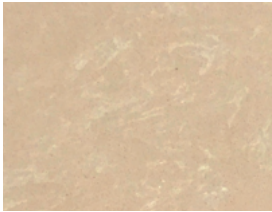

BEIGE STONE -
POLISHED SURFACE



BLUE TUNDRA MARBLE -
MATTE SURFACE



THALA BEIGE MARBLE -
MATTE SURFACE

SIGNATURE SERIES

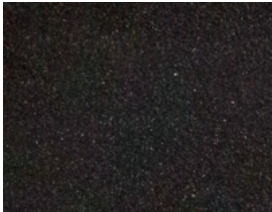

ABSOLUTE BLACK GRANITE -
POLISHED SURFACE



STEEL GRAY GRANITE -
LEATHERED SURFACE



DRIFTWOOD MARBLE -
MATTE SURFACE



PARCHWOOD MARBLE -
MATTE SURFACE

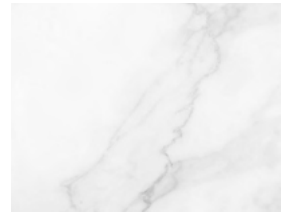

BIANCO WHITE MARBLE -
MATTE SURFACE

SELECT SERIES



PAULINE GRANITE -
POLISHED SURFACE

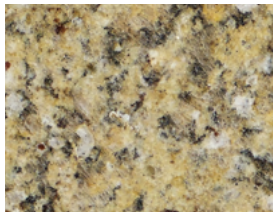

NEW VENETIAN GRANITE -
POLISHED SURFACE



SLATE - MATTE SURFACE

Stone Sets¹

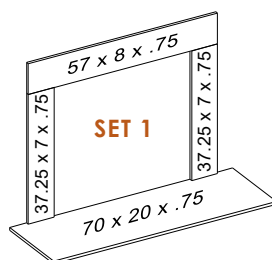

For use with most wood-burning and gas fireplaces

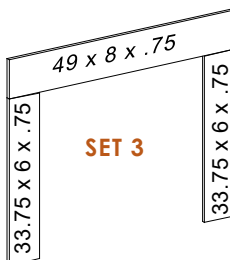
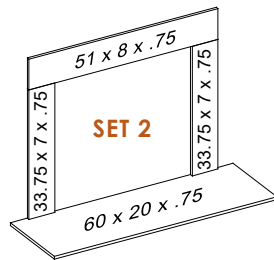

For use with most gas fireplaces

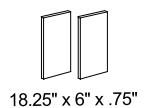
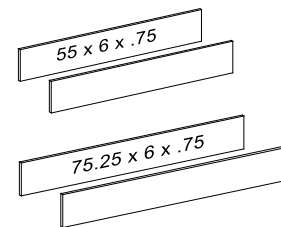

For use with most linear gas fireplaces.
Available in Driftwood only.

Mantel Shelves

Mantel shelves are a great place to display decor, add an extra cozy, personal touch, and really tie the room together. Choose from a rustic, traditional, modern or transitional look in wood or non-combustible concrete.



Wood Mantel Shelves

A mantel shelf is the perfect accent to a fireplace and a place to showcase some of your most cherished mementos. Wood mantel shelves are available in 48, 59 or 72-inch lengths.

CUSTOM STAINS



OZARK | Design Series



- TRANSITIONAL STYLE
- SHOWN WITH CUSTOM EBONY STAIN
- AVAILABLE IN 48", 59" AND 72" WIDTHS
- AVAILABLE IN EBONY, PROVINCIAL, NEW GRAY AND WHITEWASH STAIN

AVAILABLE IN



Primed MDF



Unfinished Maple



Unfinished Distressed Knotty Alder

OZARK			
A Width	48"	59"	72"
B Depth	8"	8"	8"
C Height	5"	5"	5"

FRONT

SIDE

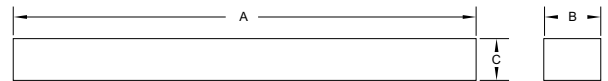

BAXTER | Signature Series



- TRADITIONAL STYLE
- SHOWN WITH CUSTOM NEW GRAY STAIN
- AVAILABLE IN 48", 59" AND 72" WIDTHS
- AVAILABLE IN EBONY, PROVINCIAL, NEW GRAY AND WHITEWASH STAIN

AVAILABLE IN



Primed MDF



Unfinished Maple

BAXTER			
A Width	48"	59"	72"
B Bottom Width	43-3/8"	54-3/8"	67-3/8"
C Top Depth	8"	8"	8"
D Bottom Depth	5-1/4"	5-1/4"	5-1/4"
E Shelf Height	4"	4"	4"

FRONT

SIDE

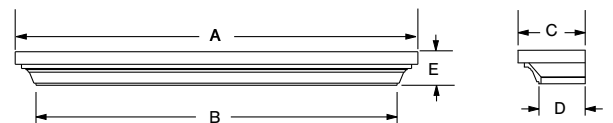

CROSBY | Signature Series



- MODERN STYLE
- SHOWN WITH CUSTOM PROVINCIAL STAIN
- AVAILABLE IN 48", 59" AND 72" WIDTHS
- AVAILABLE IN EBONY, PROVINCIAL, NEW GRAY AND WHITEWASH STAIN

AVAILABLE IN



Primed MDF



Unfinished Maple

CROSBY			
A Top Width	48"	59"	72"
B Bottom Width	45"	56"	69"
C Top Depth	8"	8"	8"
D Bottom Depth	6-1/2"	6-1/2"	6-1/2"
E Shelf Height	4-1/2"	4-1/2"	4-1/2"

FRONT

SIDE

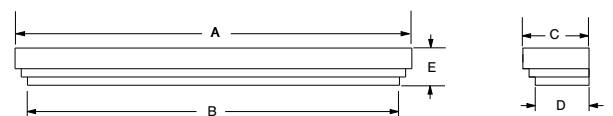



- TRANSITIONAL STYLE
- SHOWN WITH CUSTOM EBONY STAIN
- AVAILABLE IN 48", 59" AND 72" WIDTHS
- AVAILABLE IN EBONY, PROVINCIAL, NEW GRAY AND WHITEWASH STAIN

AVAILABLE IN



Primed MDF



Unfinished Maple

FILLMORE	SIZE	SIZE	SIZE
A Width	48"	59"	72"
B Shelf Depth	8"	8"	8"
C Shelf Height	2-1/2"	2-1/2"	2-1/2"

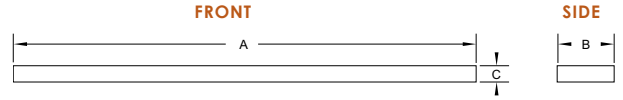

Non-combustible Mantel Shelves Design Series

Complement your gas, wood or electric fireplace with a non-combustible Supercast™ concrete shelf mantel. Supercast concrete is the perfect material for a sturdy shelf mantel for indoors or outdoors, and adds a personal touch to your fireplace.

MIDNIGHT MIST



MIDNIGHT MIST		
A Width	60"	72"
B Depth	8"	8"
C Height	5"	5"
Weight	90 lbs	104 lbs

- MODERN STYLE
- POLISHED FINISH
- AVAILABLE IN 60" AND 72" WIDTHS

COVE GRAY



COVE GRAY		
A Width	60"	72"
B Depth	8"	8"
C Height	5"	5"
Weight	90 lbs	104 lbs

- MODERN STYLE
- POLISHED FINISH
- AVAILABLE IN 60" AND 72" WIDTHS

WHITE



WHITE		
A Width	60"	72"
B Depth	8"	8"
C Height	5"	5"
Weight	90 lbs	104 lbs

- MODERN STYLE
- POLISHED FINISH
- AVAILABLE IN 60" AND 72" WIDTHS

WASHED CEDAR



WASHED CEDAR

A Width	60"	72"
B Depth	8"	8"
C Height	8"	8"
Weight	150 lbs	180 lbs

- RUSTIC STYLE
- WOODGRAIN FINISH
- AVAILABLE IN 60" AND 72" WIDTHS

WEATHERED BARNWOOD



WEATHERED BARNWOOD

A Width	60"	72"
B Depth	6-3/8"	6-3/8"
C Height	7-1/4"	7-1/4"
Weight	150 lbs	180 lbs

- RUSTIC STYLE
- WOODGRAIN FINISH
- AVAILABLE IN 60" AND 72" WIDTHS

TAVERN BROWN



TAVERN BROWN

A Width	60"	72"
B Depth	8"	8"
C Height	8"	8"
Weight	150 lbs	180 lbs

- RUSTIC STYLE
- WOODGRAIN FINISH
- AVAILABLE IN 60" AND 72" WIDTHS



Crosby shelf with Provincial stain



FOR COMPLETE INFORMATION AND VALUABLE ASSISTANCE
ON THESE MANTELS & SURROUNDS, CONTACT US AT:

1 Stone sets can be cut to fit additional fireplace sizes. Dimensions on all drawings are in inches and are for reference only. Please refer to installation manual for detailed specifications on installing this product. Mantel finishes and facing colors are only a representation of the finished look and may not be an exact color match.

The information provided in this literature is for planning purposes only and subject to change. Please consult the installation manual for actual installation. Actual product appearance may differ from product images. © 2023 Hearth & Home Technologies®

FSF-1016U-0523