

Certified by
Lab Test Certification
Meets: ANSI Z21.97-2014
CSA 2.41-2014
CSA C22.2 No. 3-M1998 (R2014)

⚠ WARNING ⚠

Improper installation, adjustment, alteration, service or maintenance can cause injury or property damage. Read the installation, operating and maintenance instructions thoroughly before installing or servicing this equipment.

⚠ WARNING ⚠

Do not store or use gasoline or other flammable vapors and liquids in vicinity of this or any other appliance.

An LP-cylinder not connected for use shall not be stored in the vicinity of this or any other appliance.

⚠ WARNING ⚠

**FOR OUTDOOR
USE ONLY**

⚠ DANGER



CARBON MONOXIDE HAZARD

This appliance can produce carbon monoxide which has no odor.

Using it in an enclosed space can kill you.

Never use this appliance in an enclosed space such as a camper, tent car or home.

⚠ WARNING ⚠

For Use with NATURAL or LP GAS Only

NO SOLID FUELS TO BE USED WITH THIS SYSTEM

⚠ DANGER ⚠

If you smell gas:

1. Shut off gas to the appliance.
2. Extinguish any open flame.
3. If odor continues, keep away from appliance and immediately call your gas supplier or fire department.

Installation must conform with local codes or, in the absence of local codes, with the *National Fuel Gas Code, ANSI Z223.1 / NFPA 54, or International Fuel Gas Code.*

The appliance, when installed, must be electrically grounded in accordance with local codes or, in the absence of local codes, with the *National Electric Code, ANSI/NFPA 70*, if applicable.

INSTALLER: Leave this manual with the appliance.
CONSUMER: Retain this manual for future reference.

⚠ AVERTISSEMENT ⚠

Une installation, un ajustement, une modification, une réparation ou un entretien inapproprié peuvent être la cause de blessures ou de dommages. Veuillez lire attentivement les instructions d'installation, d'utilisation et d'entretien avant d'installer ou de réparer ce matériel.

⚠ AVERTISSEMENT ⚠

Ne pas entreposer ni utiliser de l'essence ni d'autres vapeurs ou liquides inflammables dans le voisinage de l'appareil, ni de tout autre appareil.

Une bouteille de propane qui n'est pas raccordée en vue de son utilisation, ne doit pas être entreposée dans le voisinage de cet appareil ou de tout autre appareil.

⚠ AVERTISSEMENT ⚠

Pour utilisation
à l'extérieur seulement.

⚠ DANGER



MONOXYDE DE CARBONE
Cet appareil peut produire du monoxyde de carbone, un gaz inodore.

L'utilisation de cet appareil dans des espaces clos peut entraîner la mort.

Ne jamais utiliser cet appareil dans un espace clos comme un véhicule de camping, une tente, une automobile ou une maison.

⚠ AVERTISSEMENT ⚠

Pour utilisation avec naturel ou propane ne gaz seulement
Aucun combustibles solides pour être utilisés avec ce système

⚠ DANGER ⚠

S'il y a une odeur de gaz:

1. Coupez l'admission de gaz de l'appareil.
2. Éteindre toute flamme nue.
3. Si l'odeur persiste, éloignez-vous de l'appareil et appelez immédiatement le fournisseur de gaz ou le service d'incendie.

⚠ AVERTISSEMENT ⚠

Ne pas utiliser cet appareil s'il a été plongé, même partiellement, dans l'eau. Appeler un technicien qualifié pour inspecter l'appareil et remplacer toute partie du système de commande et toute commande qui a été plongée dans l'eau.

Table of Contents

Gas and Electrical Requirements	4
Clearance from Combustibles	5
Installation of Ignition System	6
Acceptable Media for Fire Features	8
Installation of Media in Fire Features	8
Operation	9
Maintenance	10
Replacement Parts	11
Troubleshooting	12

Gas Requirements

Fuel Type – Before making gas connections ensure appliance being installed is compatible with the available gas type. Check the label on the appliance to confirm appliance gas type requirement.

Gas Pressure – Proper input gas pressures are required for optimum appliance performance.

Gas Pressure Requirements

Pressure	Natural Gas	Propane
Minimum	3.5” W.C.	8.0” W.C.
Nominal	7.0” W.C.	11.0” W.C.
Maximum	½ psi (14.0” W.C.)	½ psi (14.0” W.C.)

Electrical Requirements

⚠ WARNING ⚠

The All Weather Electronic Ignition System operates on 12 Volts AC power ONLY
DO NOT Attempt to Power using 110 Volts AC Power – Damage WILL RESULT

Acceptable Input Voltages to Supplied 12 Volt AC Transformer

110 Volt AC

(Read label on supplied transformer for proper connection information)

Recommended Wire Size

12 gauge wire for all installations

THE OUTDOOR PLUS

Clearance from Combustibles.

This diagram applies to all fire pits and fire features

Installation

We suggest that our products be installed by professionals that are locally licensed by the authority having jurisdiction in gas piping.

Service

We suggest that our products be serviced by a professional certified in the US by the National Fireplace Institute (NFI) as NFI Gas Specialists

Flooring

All fire pits and fire features must be installed on non-combustible flooring. If the fire feature is installed on a combustible floor, such as wood decking, a non-combustible floor paneling MUST be properly installed underneath.

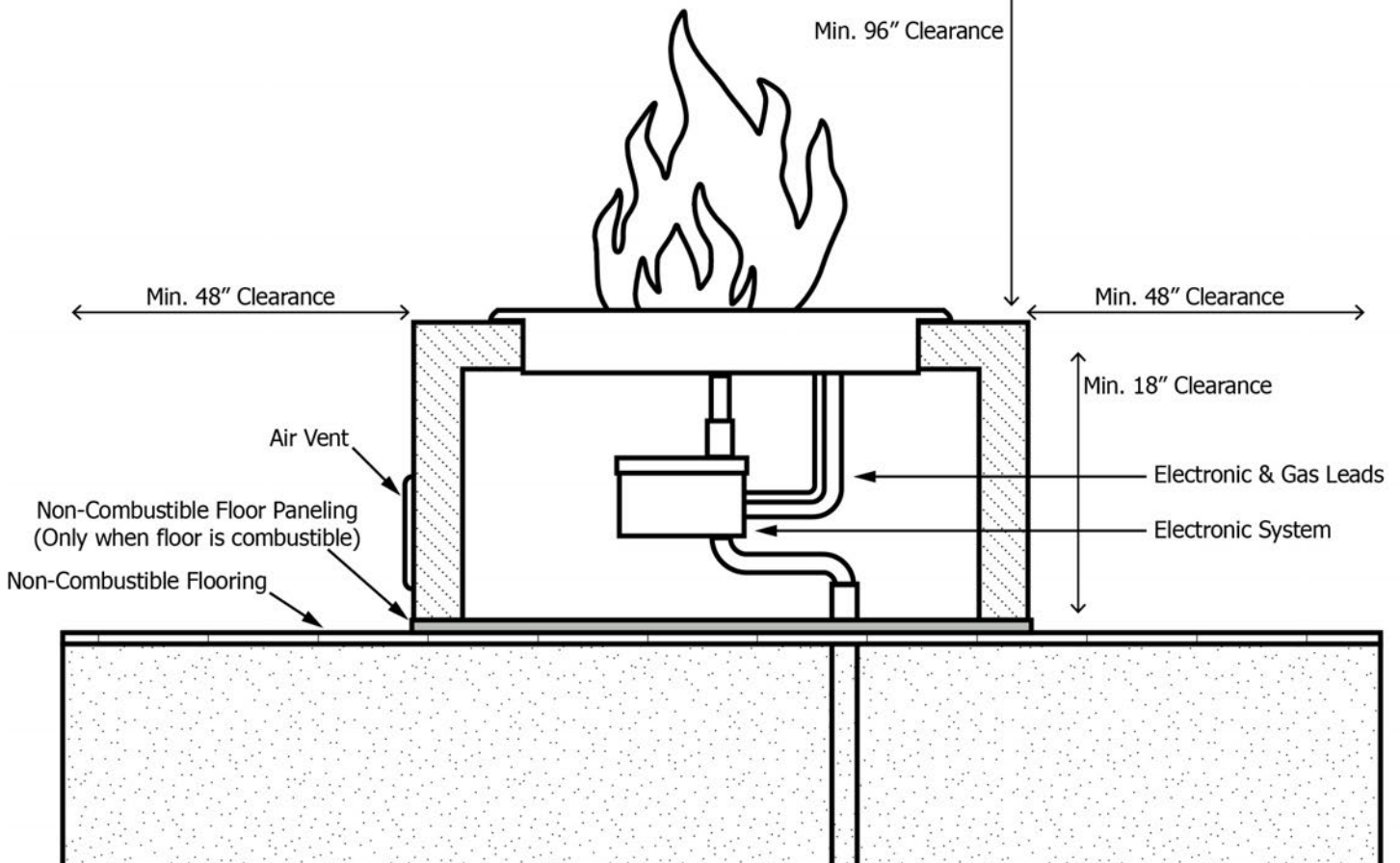

Installation

Note: Installation should be done by a qualified service technician that is locally licensed.

1. In the photo at right there is a bowl with both a gas riser and an electrical conduit stubbed up inside the bowl. In this photo the gas riser is centered whereas the electrical is off center. It is preferred to stub the gas riser centered in order to ensure the fire ring is centered in the bowl once installation is complete.

NOTE: Drainage **MUST** be provided in the bottom of the bowl.

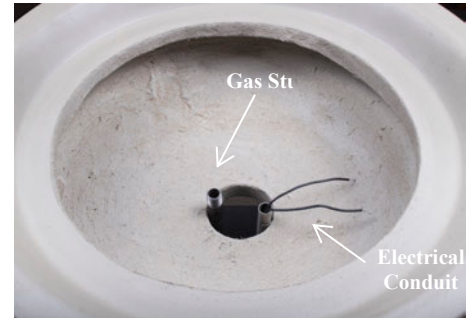

2. Apply pipe dope to the gas stub and thread the electronic valve onto the gas riser as shown in the photo at right.

NOTE: Leak Test – it is highly recommended to perform a gas leak test at this point in the install. Turn on the gas supply and then, using a soapy water solution spray the bottom of the electronic valve where it is connected to the gas line to ensure no leaks exist.



3. Electrical Connections. In the photo at right the wires protruding from the electronic valve have been connected to the two wires from the electrical conduit using appropriate sized wire nuts.

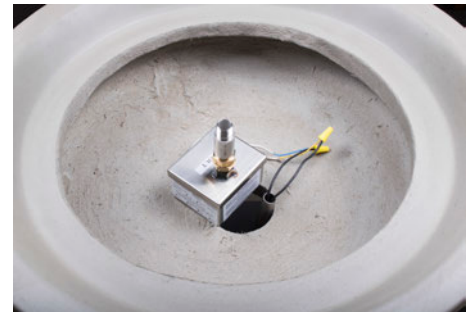

4. On the side of the electronic valve there are two connections for the Pilot Burner Assembly as shown in the photo at right. The white 'quick connect' is the electrical connection and the brass plumbing fitting is the gas connection. There is a label next to these connections, "Attach Pilot Burner Here".

5. The photo at right shows the electronic valve after the Pilot Burner Assembly has been connected.



NOTE: The electrical connection for the Pilot Burner Assembly is a shaped connection thereby ensuring it can only be connected the correct way. On the Pilot Burner Assembly side of the connection there is a locking clip on the quick connect that will 'lock' the connection in place. Therefore after making the connection lightly tug on the connection to ensure it is in fact 'locked' in place.



6a. Installation of Fire Ring - Natural Gas

When installing the fire ring for natural gas applications, select a pipe nipple that is long enough to raises the fire ring level with the top of the bowl. In this order, attach the orifice, coupling and nipple onto the valve (see illustration.) apply pipe dope or Teflon tape to all threaded, connections.

Holes on the fire ring MUST face up

To adjust the height of the flame, add a key valve onto the gas line (sold separately)



NG ORIFICE

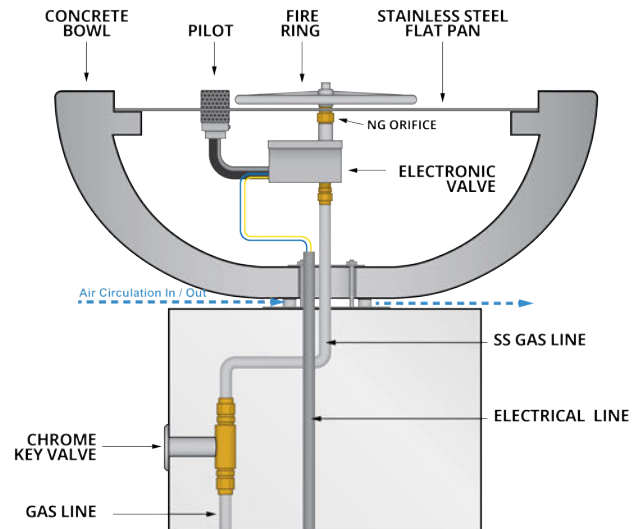

6b. Installation of Fire Ring - Liquid Propane

When installing the fire ring for propane applications, a brass air mixing orifice is required. Select a pipe nipple that is long enough to raises the fire ring level with the top of the bowl. In this order, attach the orifice, coupling and nipple onto the valve (see illustration.) apply pipe dope or Teflon tape to all threaded, connections.

Holes on the fire ring MUST face up

To adjust the height of the flame, add a key valve onto the gas line (sold separately)



LP ORIFICE

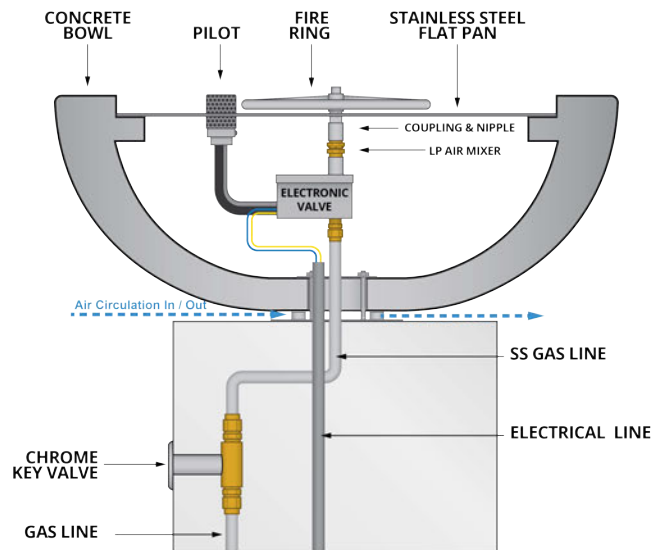

7. Install the stainless steel flat pan. This also acts as a heat deflecting shield protecting the systems. Simply place on top and pull the pilot igniter through the square cutout.

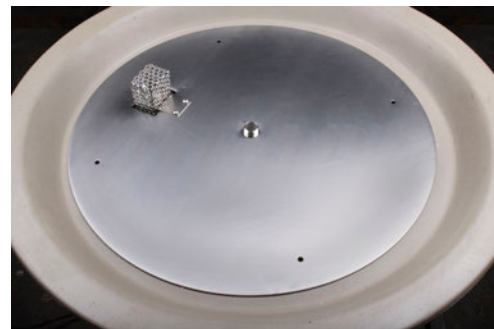

8. Install Fire Ring using either Teflon tape or gas plumbing pipe dope. Holes in the Fire Ring MUST FACE UP.



Acceptable Media for Fire Features

⚠ WARNING ⚠

Do not use any other material as topping media in in fire feature other that those listed below

Using improper media inside a fire feature could result in damage to property or injury to persons nearby due to media ‘popping’ or ‘exploding’ due to heat

List of Acceptable Media for Fire Features

Lava Rock (or other Igneous Rock) NO LARGER THAN 2” in diameter

Fireglass approved for use in fire features

Manmade stone for use in fire features (Refractory Material)

Installation Note

The use of media inside fire features is recommended due to the fact it enhances the look of the fire feature but also improves its performance by forcing the gas emanating from the burner to mix as it passes through the media. This ‘mixing’ of gases creates an even flame throughout the feature and helps spread the flame from the Pilot Burner throughout the burner quicker than when there is no media. **Recommended thickness of the media above the burner element is NO MORE than 2”.** Due to the fact the Pilot Burner must be partially exposed to oxygen in order to ignite the pilot flame during startup **DO NOT COMPLETELY COVER THE PILOT BURNER.** When installation of the media is complete the top of the Pilot Burner Protective Cover should be visible.

Installation of Media in Fire Features

Topping Material (Large Chunk Lava Rock)

There are several options when it comes to topping material for a fire feature; large chunk lava rock, fireglass and fire stones. In the photo at right we used large chunk lava (2” to 3”) to cover the fire ring. This lava rock hides the components of the fire feature while at the same time allowing plenty of oxygen to mix with the gas coming from the fire ring. This lava rock is more expensive than the ‘filler’ lava rock but is still fairly inexpensive and readily available in the BBQ section of most hardware stores.

Notice in the photo at far right the Pilot Burner is Concealed by the lava rock but NOT completely buried.



***Keep the top of the pilot exposed**

Topping Material (Fireglass - Installation)

IMPORTANT: The top of the Pilot Burner should be level with the top of the Fireglass.

NOTE: If after installing the fireglass you notice the Pilot Burner is having difficulty igniting, remove some of the fireglass over the top of it. Continue to remove glass and try turning the fire feature on until you are able to achieve ignition every time you turn the fire feature on. This part requires some experimenting on your part to determine ‘how much’ glass you can have on top of the Pilot Burner.

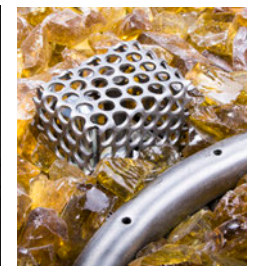

***Keep the top of the pilot exposed**

Operation

▲ WARNING ▲

Do NOT use this appliance if any part has been under water.
Immediately call a qualified service technician to inspect the appliance and to replace any part of the control system and any gas control which has been under water.

▲ WARNING ▲

HOT – DO NOT TOUCH - SEVERE BURNS MAY RESULT - CLOTHING IGNITION MAY RESULT

- CAREFULLY SUPERVISE children in same area as the appliance.
- Alert children and adults to hazards of high temperatures.
- Clothing or other flammable materials should not be hung from the appliance or placed on or near the appliance.

▲ WARNING ▲

The appliance should be inspected before use and at least annually by a qualified service technician.

Any guard or protective device removed for servicing must be replaced prior to operation.

Keep the appliance area clear and free from combustible materials, gasoline and other flammable vapors and liquids.

Fire Feature Start Up

1. Prior to turning appliance on visually inspect fire feature to ensure debris such as leaves or other combustible material has not collected inside the feature which could burn and emit embers once the fire feature is turned on. Also ensure any person standing close to the fire feature is aware you will be turning the fire feature on prior to actually turning it on.
2. Turn fire feature on by turning on the electrical device used to power the fire feature.

Sequence of Operation during Ignition

- Power is applied
- Hot Surface Igniter (Glow Plug) becomes hot and 4 seconds later the Pilot Gas Valve opens
- Within 10 seconds of power application Pilot Flame should be visible (at night only)
- Within 10 seconds of Pilot Flame Ignition burner (fire ring/burner bar) should ignite

Fire Feature Shutdown

1. Turn fire feature off by turning off the electrical device used to power the fire feature.

▲ WARNING ▲

If fire feature fails to turn off completely (small flames still visible)
Turn off gas supply using the manual gas shutoff.

Maintenance

▲ WARNING ▲

Maintenance should be done by a qualified service technician.
The appliance should be inspected before use and at least annually by a qualified service technician.

▲ WARNING ▲

Ensure gas and power are shut off and appliance is cool before servicing.

▲ WARNING ▲

Any guard or protective device removed for servicing must be replaced prior to operation.

Prior to Each Use

1. Inspect for debris in Fire Feature – remove debris prior to use

Semi-Annually

1. Visually inspect Pilot Burner for debris/insect infestation (spider webs)
2. Visually inspect burner holes for debris/insect infestation
3. Clean either of the above as necessary using compressed air.

Annually

1. Visually inspect Pilot Burner for excess corrosion due to heat and moisture.
2. Turn fire feature on to ensure proper operation.

Replacement Parts

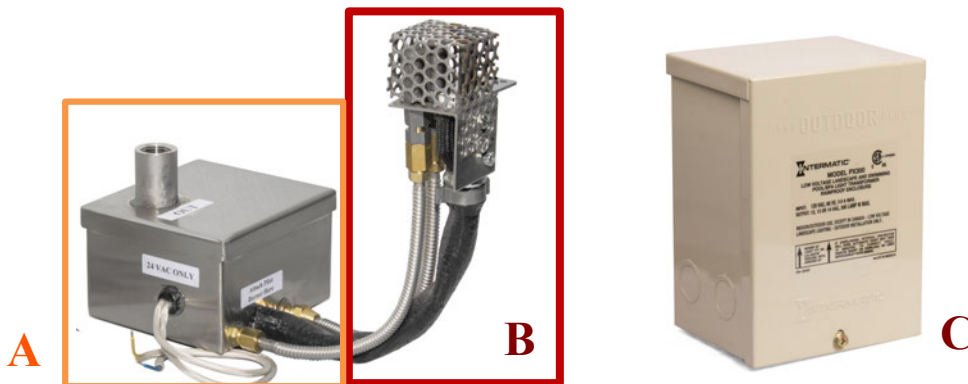

Item Letter	Part Name	Part #
A	Electronic Valve (Not Sold Separately)	
B	Pilot Igniter Assembly	OPT-PIRCG
C	12V Transformer	OPT-12V

Troubleshooting

I installed the Electronic Ignition System, turned it on and nothing happened

When this occurs it is usually due to an electrical wiring / power issue. Check all your electrical connections thoroughly to ensure all wires at the transformer and inside the fire feature are connected properly. If it appears all wiring is connected properly, disconnect the wires at the fire feature, attach a Multimeter to the wires to confirm a minimum of 12 volts when the fire feature is turned on. If you determine that you do not have a minimum of 12 volts at the fire feature conduct the same test at the transformer to ensure the transformer is in fact producing a minimum of 12 volts. If you do have a minimum of 12 volts at the fire feature contact us for further assistance.

I installed the Electronic Ignition System, turned it on and I can see the glow plug glowing orange and I can hear gas flowing but it will not ignite.

There are two possible causes to this problem; **Air in the Gas Line** or not enough **Electrical Current** to the fire feature.

Air in the Gas Line. If a new gas line was installed and the air was never purged from it prior to installing the Electronic Ignition System then it may take several times of turning the fire feature on and off before the air is purged from the gas line. Here is how our system works; after you turn it on the glow plug will come on first followed by the Pilot Gas Valve opening 4 seconds later. For the next 180 seconds (3 minutes) the glow plug will cycle on and off every 30 seconds while the Pilot Gas Valve will remain on the entire time. Therefore if you are attempting to purge air from the gas line, turn the system on and leave it on for approximately 3 minutes. Then turn it off and then back on (no need to wait to turn it back on). Let the system run for another 3 minutes. Usually when purging air from a new gas line you will need to cycle the power several times as described above before gas begins to flow. If at any point you smell gas but still don't have ignition, attempt to light the Pilot flame with a handheld lighter. If the flame ignites when you light it by hand, go to the section below, "Electrical Current".

Electrical Current. If you have determined that air in the gas line is not the problem then most likely the failure to ignite is due to the fact the glow plug is not getting hot enough to ignite the gas. The reason a glow plug will not get hot enough is due to the fact it is not getting enough 'amps'. Often times when troubleshooting electricians will check the electrical power and when they see they have a minimum of 12 volts they think everything is fine electrically so there must be a problem with the Electronic Ignition System. The problem is not due to the volts but rather the amps. The number of amps reaching the fire feature is heavily dependent on the gauge wire used between the transformer and the fire feature. Our Install Instructions require no less than 12 gauge wire be run for all fire features. Often times we learn that in many cases less than 12 gauge wire has been used and herein lies the cause of the problem.

Here is how you check to determine if enough Electrical Current (amps) are getting to the fire feature:

1. CAUTION: Turn off the gas supply prior to the next step.
2. Using a clamp on ammeter, clamp the ammeter around one of the wires providing power to the Electronic Ignition System.
3. Turn the fire feature on.
4. The amps you should see will range between 1.4 to 1.6 amps initially. Four seconds after being turned on the amps will jump to approximately 2.0 amps.

If you do not see the amps listed above AND the wire gauge used was less than 12 gauge wire – change the wiring. Otherwise contact us for further assistance.

I turned the Fire Feature off but I still see small flames emanating from the fire feature.

Turn the fire feature on, let the main fire ring light and then turn it off again – do this several times. Small pieces of debris from the gas line can get caught in the main or pilot valve thereby preventing it from closing all the way. This will sometimes happen with a new gas line. By cycling power you can often times dislodge the debris. If cycling power does not rectify the problem, turn the gas off using the manual gas shutoff and contact us for further assistance.

12 Volt Control Panel

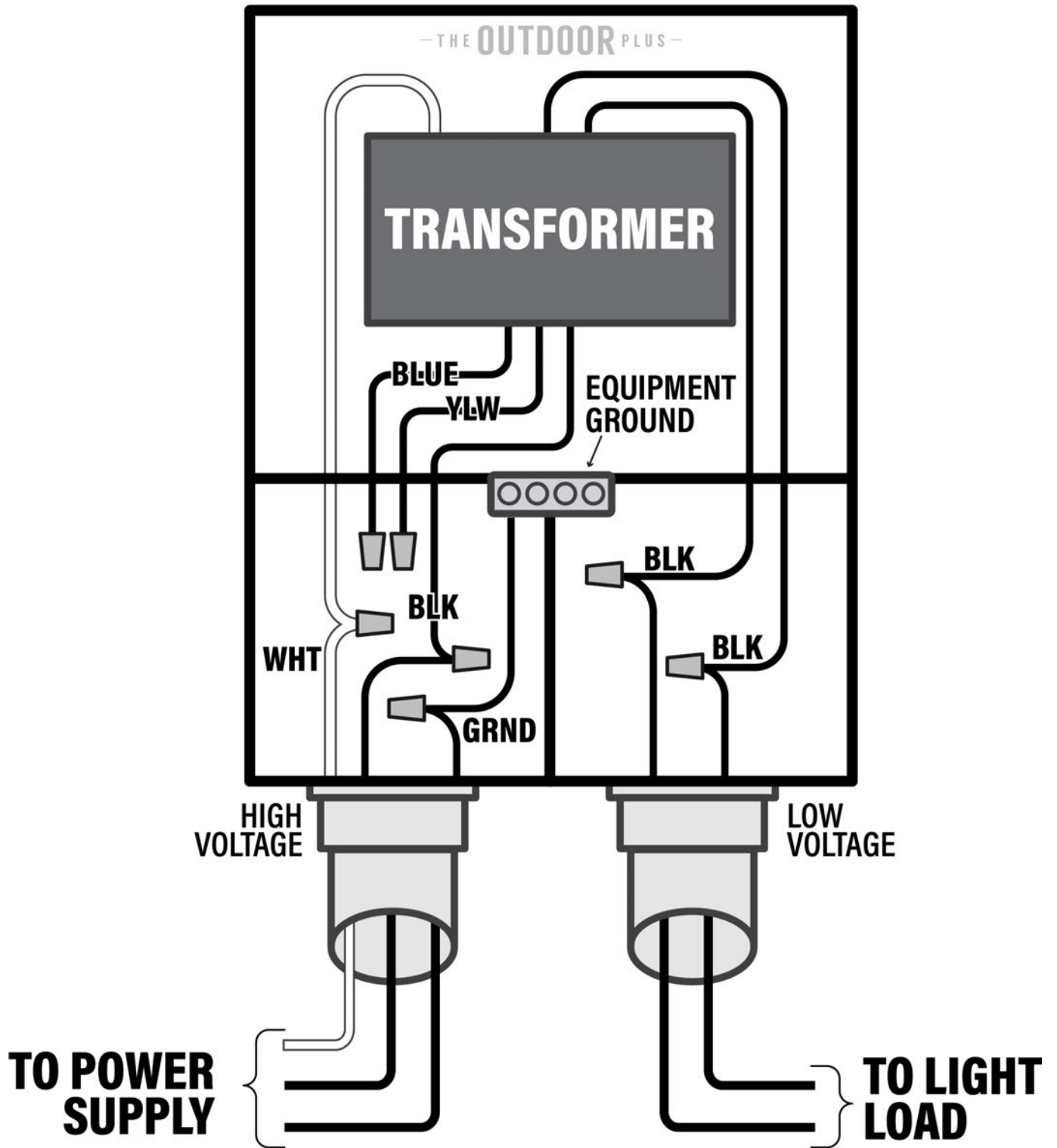

Accessories



2-Hour Electronic Timer - OPT-DTM

The electronic timer runs **ONLY** on 110V.

6" of slack are provided to ease the installation process.

The timer is outdoor rated but we recommend the time to be away from wet and hot conditions.

Minimum operating temperature: 32° F

Maximum operating temperature: 104° F

Dimensions: Height: 4-1/2" , Width: 2-3/4" , Depth: 2-1/8"



Emergency Stop - OPT-ESTOP

The emergency stop runs **ONLY** on 110V.

Outdoor rated. Mounted in j-box with a weather proof cover.

Includes 1/2" female thread to accommodate conduit

Minimum operating temperature: 32° F

Maximum operating temperature: 105° F

Dimensions: Height: 4-3/4" , Width: 2-7/8" , Depth: 2"