

Firebox Collection

96" Firebox SS

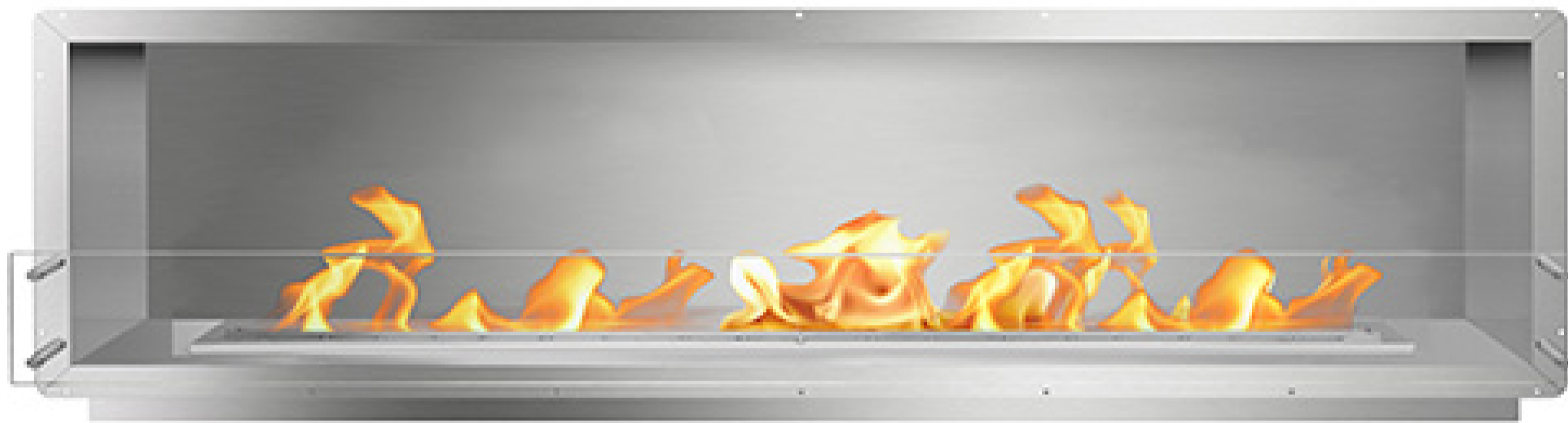

Black



Included Accessories



Lighting Rod



Lighter



Funnel

Firebox Collection

96" Firebox SS

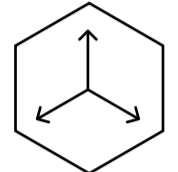
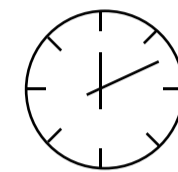
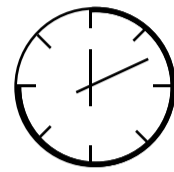
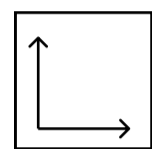
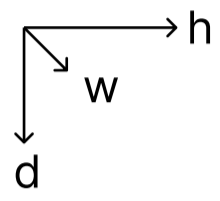

Dimensions H x W x D mm/in	Fuel Capacity	Heats on Average (indoors)	Fuel Consumption	Thermal Output Net (MAX)	Approx. Burn Time	Minimum Room Size (per burner)
686 × 2438 × 381 27.0 × 96.0 × 15.0	18L	Over 169m ² [1,819 ft ²]	1.09L per hour	47,400 BTU/h 13.9 Kw	16 hours	400 sq. ft.

Awards

2010 Winner Outdoor Hearth Products
Vesta Awards

Application

Indoor & Outdoor

Burner Colour

● Stainless Steel ● Black

Materials

Brushed Stainless Steel Internal Frame
8mm Tempered Glass

Burner Size

72" Burner

Fuel Type

Bio Ethanol Fuel

Other

- Double Walled Design
- Fully Insulated
- 304 Stainless Steel Firebox Construction

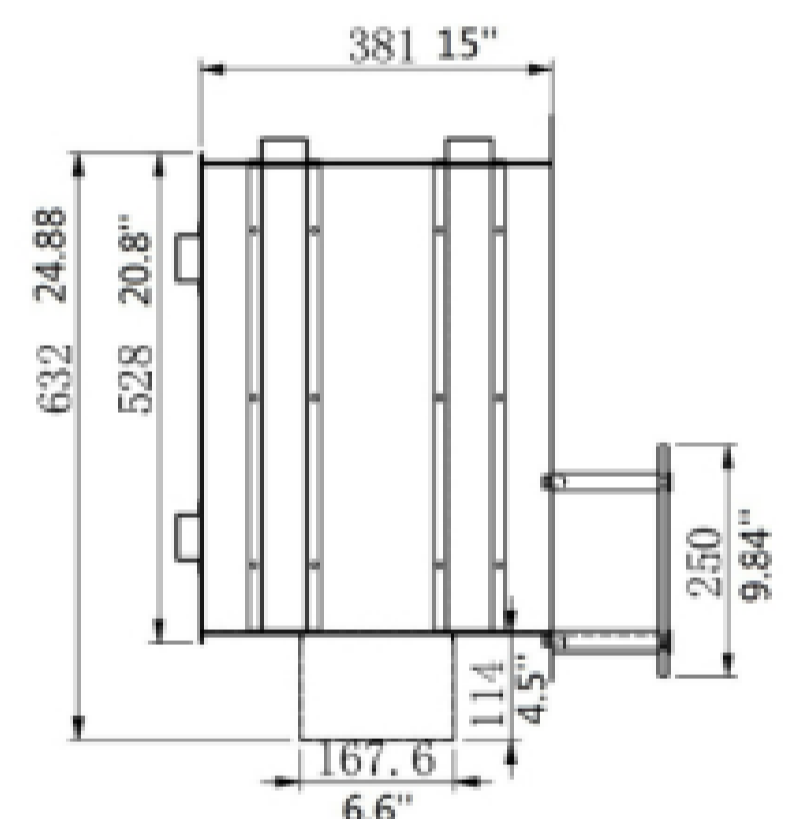

Global Compliance
All burners are UL Listed in accordance with ANSI/
UL1370 in the USA and comply with the ACCC Safety
Mandate for Australia.



Lifetime Warranty

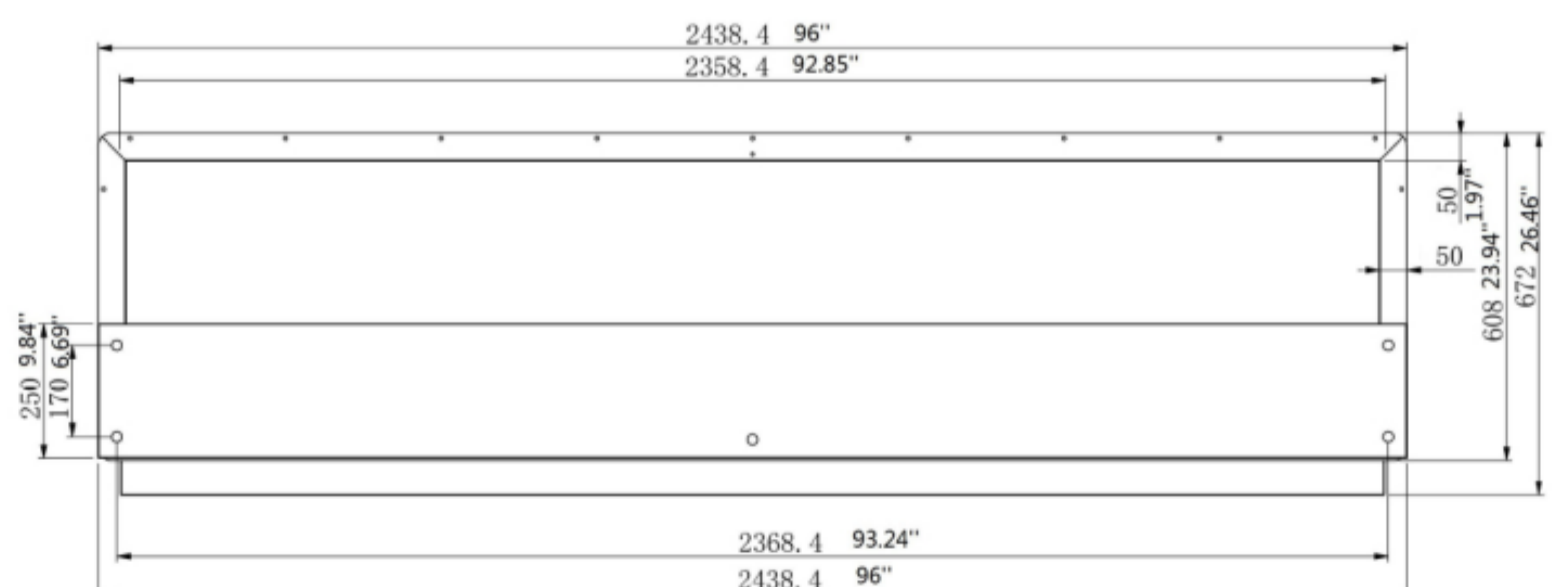

FOR MORE INFORMATION PLEASE REFERENCE THE CLEARANCE & INSTALLATION MANUAL

*Dimensions may vary by 2% (plus or minus) due to material attributes. Template not provided. The Bio Flame recommends using the actual fireplace or burner model when making final cut out

