

# Firebox Collection

## 72" Firebox DS

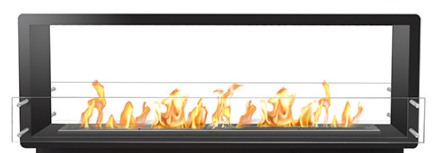

**Black**



### Included Accessories



**Lighting Rod**



**Lighter**



**Funnel**

# Firebox Collection

## 72" Firebox DS

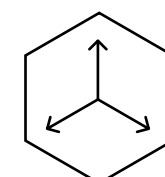
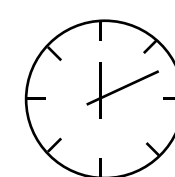
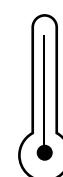
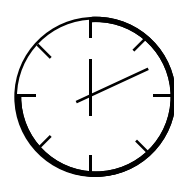
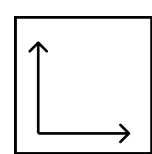
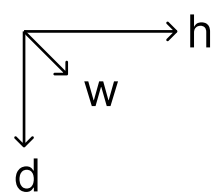

Dimensions H x W x D mm/in	Fuel Capacity	Heats on Average (indoors)	Fuel Consumption	Thermal Output Net (MAX)	Approx. Burn Time	Minimum Room Size (per burner)
672 x 1524 x 381 26.5 x 60.0 x 15.0	14L	Over 107m <sup>2</sup> [1,152 ft <sup>2</sup> ]	0.67L per hour	33,500 BTU/h 9.8 Kw	21 hours	250 sq. ft.

### Awards

2010 Winner Outdoor Hearth Products  
Vesta Awards

### Application

Indoor & Outdoor

### Burner Colour

● Stainless Steel ● Black

### Materials

Brushed Stainless Steel Internal Frame  
8mm Tempered Glass

### Burner Size

48" Burner

### Fuel Type

Bio Ethanol Fuel

### Other

- Double Walled Design
- Fully Insulated
- 304 Stainless Steel Firebox Construction

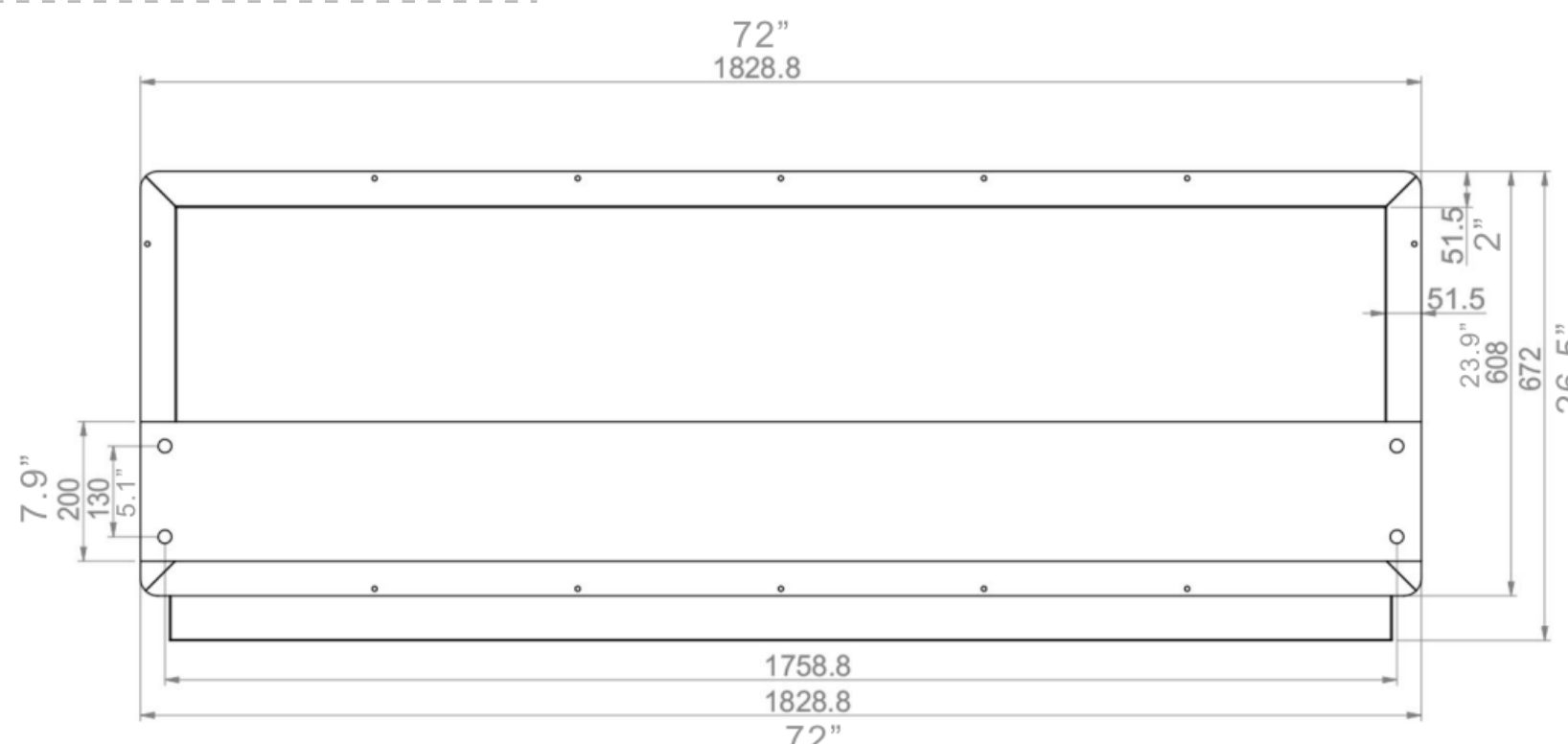
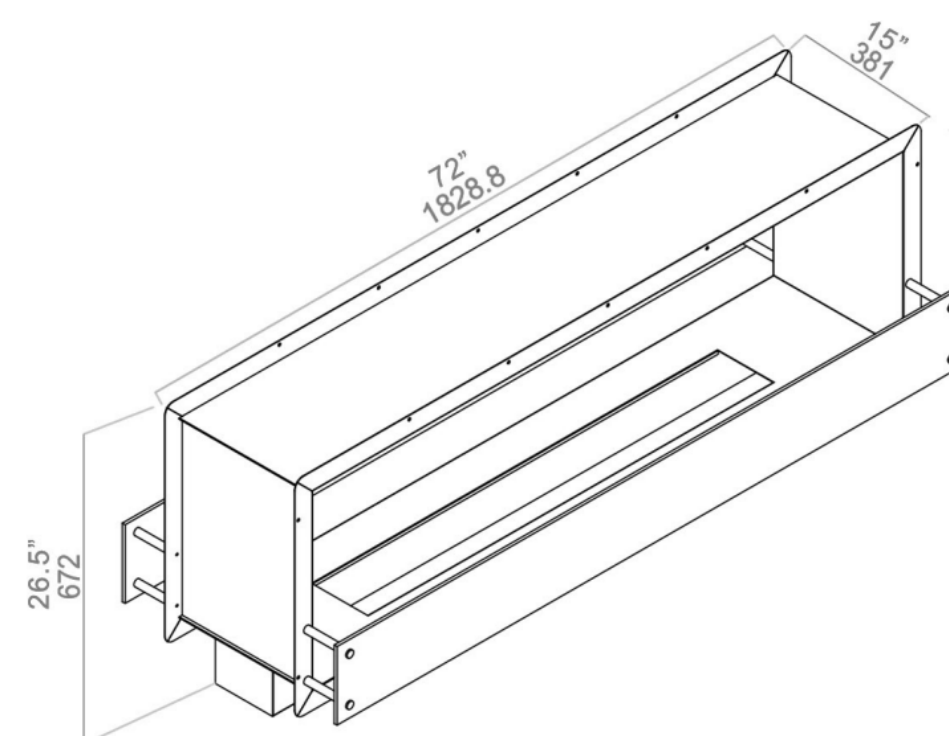

Global Compliance  
All burners are UL Listed in accordance with ANSI/  
UL1370 in the USA and comply with the ACCC Safety  
Mandate for Australia.



Lifetime Warranty

FOR MORE INFORMATION PLEASE REFERENCE THE CLEARANCE & INSTALLATION MANUAL

\*Dimensions may vary by 2% (plus or minus) due to material attributes. Template not provided. The Bio Flame recommends using the actual fireplace or burner model when making final cut out

