



Models

RBF24DLX - 6909990100
RBF24DLXWC - 6909990200

Owner's Manual



We value your feedback!

Your input helps to create even better products and experiences.

Share the warmth and leave a review.
[dimplex.com/sharethewarmth](https://www.dimplex.com/sharethewarmth)

 [YouTube/Dimplex](https://www.youtube.com/Dimplex) 











IMPORTANT SAFETY INFORMATION:

Read this manual first before attempting to install or use the Revillusion™ Electric Fireplace. Always comply with the warnings and safety instructions contained in this manual to prevent personal injury or property damage.

To view the full line of Dimplex products, visit www.dimplex.com



Table of Contents

	Welcome	3
	IMPORTANT INSTRUCTIONS	4
	Specifications	6
	Installation	7
	Electrical	10
	Operation.....	17
	Maintenance	20
	Warranty	22
	Technical Support.....	23

 **SAVE THESE INSTRUCTIONS** 

Conventions used in this manual:

! NOTE: Procedures and techniques considered important enough to emphasize.

⚠ CAUTION: Procedures and techniques which, if not carefully followed, will result in damage to the equipment.

⚡ WARNING: Procedures, precautions and techniques which, if not carefully followed, will expose the user to the risk of fire, serious injury, or death.

Welcome

Thank you for purchasing a Revillusion™ Electric Fireplace by Dimplex. Please use our convenient online registration page to record your model and serial numbers for future reference at:

www.dimplex.com/register

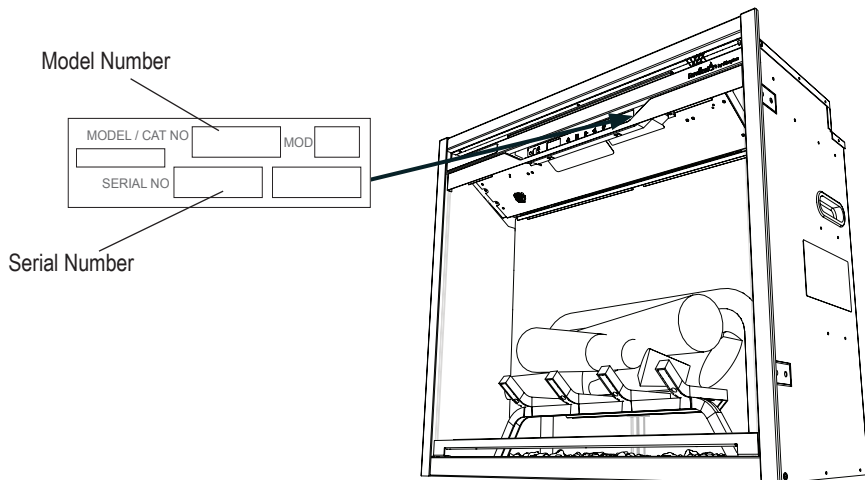

⚠ CAUTION: Read all instructions and warnings carefully before starting installation. Failure to follow these instructions may result in a possible electric shock or fire hazard and will void the warranty.



NO NEED TO RETURN TO THE STORE

Questions with operation or assembly? Require Parts Information?
Product Under Manufacturer's Warranty?

Contact us at:  **www.dimplex.com/support**
For Troubleshooting and Technical Support

OR  **Toll-Free 1-888-346-7539**

In order to better serve you, please have your model and serial numbers ready or register your product online before calling (see above).



IMPORTANT INSTRUCTIONS

Basic Precautions

When using any electrical appliance, basic precautions should always be followed to reduce the risk of fire, electric shock, and injury to persons. These precautions include:

- ① Read all instructions before using the Revillusion™ Electric Fireplace.

⚠ DANGER: High temperatures may be generated under certain abnormal conditions. Do not partially or fully cover or obstruct the front of the fireplace.

- ② This fireplace is hot when in use. To avoid burns, do not let bare skin touch hot surfaces. The trim around the heater outlet becomes hot during heater operation. Keep combustible materials, such as furniture, pillows, bedding, papers, clothes, and curtains at least 3 feet (0.9 m) from the front of the fireplace.
- ③ Extreme caution is necessary when the fireplace is used by or near children or invalids and whenever the fireplace is left operating and unattended.
- ④ Always turn off the fireplace when it is not in use.
- ⑤ Do not operate the fireplace after it malfunctions, has been dropped, or damaged in any manner. Disconnect power at the service panel and have the fireplace inspected by a reputable electrician before using.
- ⑥ Do not use this fireplace outdoors.
- ⑦ Never locate the fireplace where it may fall into a bathtub or other water

container.

- ⑧ Do not insert or allow foreign objects to enter any ventilation or exhaust opening as this may cause an electric shock, or fire, or damage the fireplace.
- ⑨ To prevent a possible fire, do not block air intakes or exhaust in any manner
- ⑩ To disconnect the heater, turn the controls to OFF and turn off the power to the heater circuit at the main disconnect panel.
- ⑪ All electrical heaters have hot and arcing or sparking parts inside. Do not use it in areas where gasoline, paint, or flammable liquids are used or stored.
- ⑫ Do not modify this fireplace. Use it only as described in this manual. Any other use may cause fire, electric shock, or injury to persons.
- ⑬ Do not burn wood or other materials in this fireplace.
- ⑭ Disconnect all power coming to the fireplace at the main service panel before performing any cleaning or maintenance.
- ⑮ When transporting or storing the fireplace, keep it in a dry place, free from excessive vibration, and store to avoid damage.

! NOTE: Changes or modifications not expressly approved by the party responsible for compliance could void user's authority to operate the equipment.

IMPORTANT INSTRUCTIONS

Special Precautions

 **WARNING:** Remote control contains a small battery. Keep away from children. If swallowed, seek medical attention immediately.

 **WARNING:** Do not install battery backwards, charge, put in fire or mix with used or other battery types as it may explode or leak causing injury.

 **WARNING:** Do not open the unit. There is a risk of electric shock. There are no user-serviceable parts inside.

 **CAUTION:** Always use a qualified technician or service agency to repair the electric fireplace.

FCC Compliance

 **CAUTION:** This unit has been tested and found to comply with the limits for Class B digital device, pursuant to part 15 of the FCC Rules. These limits are designed to provide reasonable protection against harmful interference in a residential installation. This unit generates, uses and can radiate radio frequency energy and, if not installed and used in accordance

with the instructions, may cause harmful interference to radio or television reception, which can be determined by turning the unit OFF and ON, the user is encouraged to try to correct the interference by one or more of the following measures:

- Reorient or relocate the receiving antenna.
- Increase the separation between the unit and the receiver.
- Connect the unit into an outlet on a circuit different from that to which the receiver is connected.
- Consult the dealer or an experienced radio/TV technician for help.

This unit complies with Part 15 of the FCC Rules. Operation is subject to the following two conditions: (1) This unit may not cause harmful interference, and (2) this unit must accept any interference received, including interference that may cause undesired operation.

 **FCC CAUTION:** Any changes or modifications not expressly approved by the party responsible for compliance could void the user's authority to operate this equipment.



CAUTION
RISK OF ELECTRIC SHOCK
DO NOT OPEN
NO USER-SERVICEABLE PARTS INSIDE



Specifications

The Revillusion™ Electric Fireplace offers an alternative to a wood or gas fireplace. It can give your existing fireplace new life or transform a cabinet or media center of your own into a stunning focal point.

Electrical

Volts	120 V 60 Hz
Amps	11.25 A @ 25° C 12.50 A @ 0° C
Watts	1350 W @ 25° C 1500 W @ 0° C
Wiring	Plug-in fireplace, hardwire optional
Bulb Type	LED
Approvals	

Dimensions

	RBF24DLX	RBF24DLXWC
Width	24 ¼" 640 mm	24 ¼" 640 mm
Height	22 ⅞" 581 mm	22 ⅞" 581 mm
Depth	12 ⅞" 307 mm	12 ⅞" 307 mm

Operation Temperature

-4° to 104° F (-20° to 40° C)

 **WARNING:** Electrical outlet wiring must comply with local building codes and other applicable regulations to reduce the risk of fire, electric shock, or injury to persons.

! NOTE: A 15 Amp circuit is required. A dedicated circuit is preferred, but not essential in all cases. A dedicated circuit will be required if, after installation, the circuit breaker trips or the fuse blows on a regular basis when the heater is operating. Additional appliances on the same circuit may exceed the current rating of the circuit breaker.

Unpacking the Unit

The unit comes packed with a protective sheet covering the front of the unit. This sheet is intended to prevent dust and debris from entering during construction. This sheet is designed so that it can be partially removed to complete the wiring and unpacking and can be reinstalled until the final installation is complete.

The log set was installed on the grate and the grate permanently fixed to the fireplace at the factory.

Carefully remove the packaging from around the log set. Make sure the wires from the log set are connected securely to the grate box.

 **CAUTION:** The Realogs® contain LEDs to create a unique pulse and glow effect. Handle the log set carefully. They are fragile and can crack or break if dropped.

Installation

Framing

1. The Revillusion™ Electric Fireplace/ Fireplace Insert does not require any special venting.
2. To build the rough-in opening, follow the framing dimensions below.

! NOTE: The materials used for the finished surround must be cut to precise dimensions (dimensions B & C) as the 1/4" (0.6 cm) self trimming flange is only to create a finished appearance.

	RBF24DLX	RBF24DLXWC
A	12 1/2" (318 mm)	12 1/2" (318 mm)
B	24 5/8" (626 mm)	24 5/8" (626mm)
C	22 3/8" (568 mm)	22 3/8" (568 mm)
D	22 1/8" (562 mm)	22 1/8" (562 mm)
E	12 1/8" (307 mm)	12 1/8" (307 mm)
F	23 3/8" (595 mm)	23 3/8" (595 mm)
G	25 1/4" (640 mm)	25 1/4" (640 mm)
H	19" (483 mm)	19" (483 mm)
I	22 7/8" (581 mm)	22 7/8" (581 mm)
J	47 3/4" (1213 mm)	47 3/4" (1213 mm)
K	33 3/4" (857 mm)	33 3/4" (857 mm)
L	33 3/4" (857 mm)	33 3/4" (857 mm)

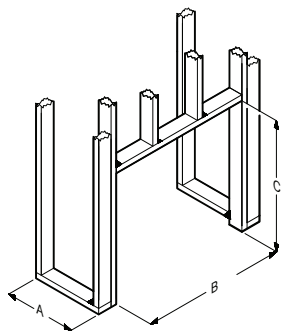

Rough-In Framing Dimensions

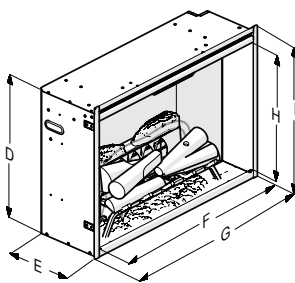

Fireplace Dimensions
Dimensions

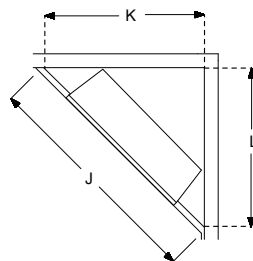

Rough-In Corner

Installation

Front Glass Installation Method

1. Before installing the front glass installation, remove the hole caps from the fireplace.

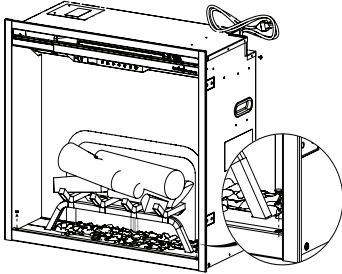

2. Make sure all hardware has been included in package prior to starting.



A
x2



B
x2



C
x2



D
x4

3. Install hardware items A and B onto front glass.

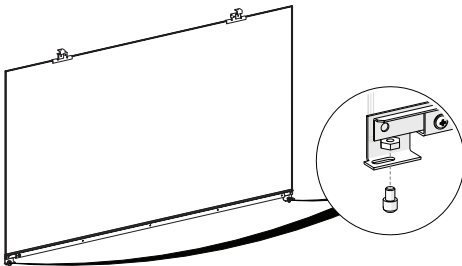

4. Install brackets onto fireplace with screws C.

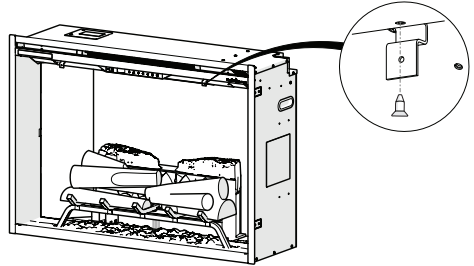

5. Place front glass into fireplace and secure with screw D

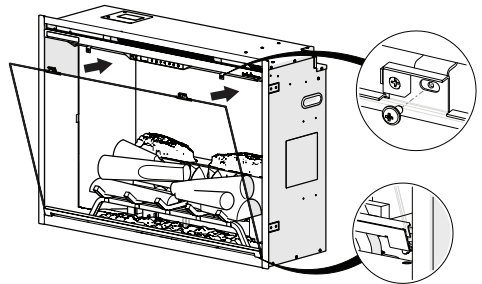

6. Install top trip piece.

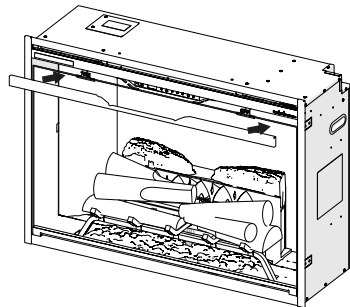

Installation

Placement

This fireplace is a zero clearance design, with the exception of the top of the unit, where any insulation and vapor barrier should be placed a minimum of 2" (5.1 cm) from the fireplace.

⚠ CAUTION: The front of the firebox must not be recessed as this will prevent adequate airflow out of the heater.

⚠ DANGER! High temperatures may be generated under certain abnormal conditions. Do not partially or fully cover or obstruct the front of the fireplace.

⚠ WARNING: All electrical heaters have hot and arcing or sparking parts inside. Do not use it in areas where gasoline, paint, or flammable liquids are used or stored.

⚠ WARNING: The electric fireplace must NOT be in direct contact with any building vapor barrier or insulation.

! NOTE: If the fireplace is going into an existing opening and used with the trim accessory, locate the fireplace as needed for the the best appearance.

1. Place the fireplace into the opening. Level with shims if necessary.
2. From the inside of the unit, gently remove the interior brick panels (attached magnetically).

3. Screw the mounting flanges directly to the stud opening or bend the flange out to 90° to be flush with the surrounding studs and screwed to the studs using suitable hardware.

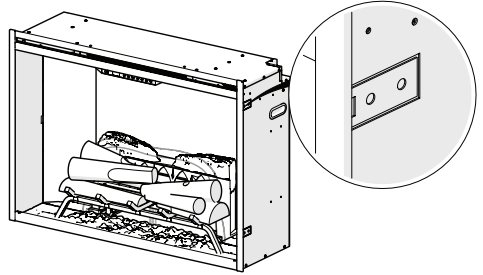

Bathroom Installation

This electric fireplace must be protected by a GFI circuit when installed in an area where water is present. If the unit is installed using a receptacle, it must be readily accessible.

This fireplace is not watertight and must be installed as to prevent water from entering the unit. Install the unit away from showers, tubs, etc. Keep towels and other combustible materials 3 feet (0.9 m) away from the front of the unit.

General

The fireplace is packaged with a three prong plug installed for plug-in convenience. Hard wiring the fireplace is also an option for installation.

⚠ WARNING: Do not attempt to wire your own new outlets or circuits. To reduce the risk of fire, electric shock or injury to persons, always use a licensed electrician.

⚠ WARNING: Make sure the circuit on which the fireplace is to be installed has the power cut off at the service panel until installation is complete.

Power Cord

⚠ WARNING: This fireplace is for use on a 120V circuit and has a grounding plug that looks like the plug in Figure 1. Make sure the plug is connected to an outlet having the same configuration as the plug. No adapter should be used with this product.

Figure 1

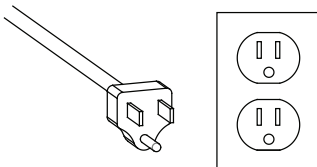

⚠ WARNING: Do not use this fireplace with an extension cord. Plug the cord directly into an appropriate wall receptacle.

Removing Power Cord for Hardwire Installation

To remove the power cord:

1. Locate the power cord on the back of the fireplace. Remove 2 screws and slide the electrical box back.

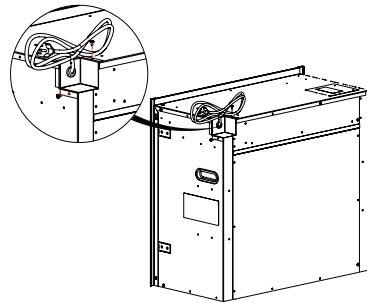

2. Unscrew the 2 wire connectors.
3. Cut the green (ground wire) leaving enough length to reuse the wire.
4. Replace assembly with the hardwire cover (included).

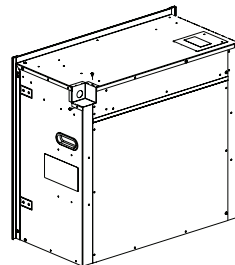



Permanent Heat Disable

The fireplace heater can be permanently disabled by removing the electronic jumper on the main control board. Disable the heater before any additional installation takes place.

To permanently disable the heater:

1. Locate and remove the panel on the top left of the unit.
2. Pull out the electronic jumper (shunt), on the on the left side of the screw in the right corner of the board. The label beside the jumper is "HT EN".
3. Reinstall the previously removed panel.

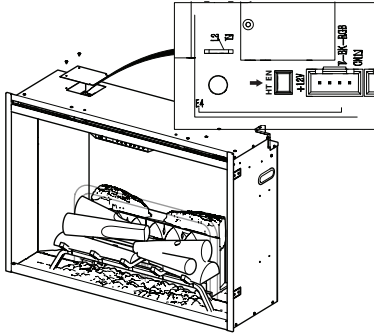

! **NOTE:** If heater button is pressed when heater is permanently disabled, H-- will be displayed.

Hardwire Installation

1. Allow 8" (20.3 cm) of service cable for connecting the power supply wires to the junction box on the unit when installing before finishing the wall. Allow up to 4 ft (122 cm) of service cable for connecting the power supply wires to the junction box when installing after finishing the wall.
2. Wire a dedicated, properly fused circuit with a 15 A rating.
3. Feed the service cable through the electrical cover on the back of the unit and secure using a 1/2" (1.3 cm) approved strain relief connector.
4. Remove the outer jacket and strip the individual conductors 1/2" (1.3 cm) from the end.
5. Follow the instructions pertaining to your specific installation.
6. Wiring inspection can be done from the front of the unit: remove the access panel, to the right of the controls, to access the service cable and wires from the unit.



Direct Power Wiring (120 V)

All wiring must be completed prior to installing the electric fireplace.

Use 2-conductor wires with ground (3 wires total) from the power supply (breaker panel) to the junction box on the electric fireplace.

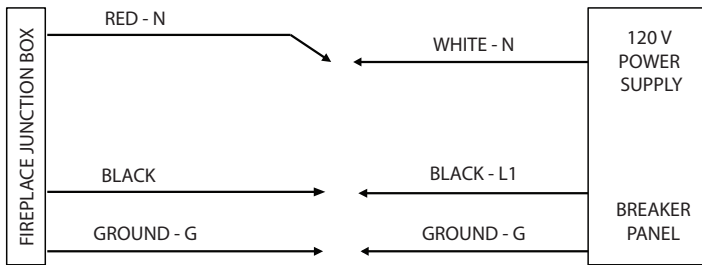

To install 120 V direct power wiring:

1. Pull out the red-N, black-L, and green-G wires.
2. Connect N (white) and N (red) in the electric fireplace to the neutral wire from the power supply.
3. Connect L (black) wire from the electric fireplace to the live wire from the power supply.
4. Connect the G (green) ground wire from the electric fireplace to the ground from the power supply.
5. Insert all the wiring back into the electric fireplace and secure with a cable clamp.
6. Make sure all connections are tight.

Wall Switch (120 V)

! NOTE: Use a single pole, single throw (On/Off) wall switch that is rated for a minimum of 15 A.

Before installing the wall switch:

- Connect a 2-conductor wire with ground (3 wires total) from the power supply panel to the main switch wall box.
- Connect a 2-conductor wire with ground (3 wires total) from the main switch wall box to the junction box on the fireplace.

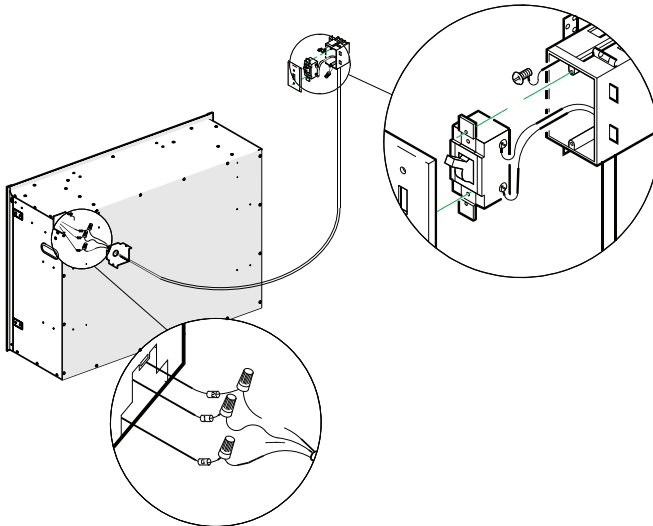
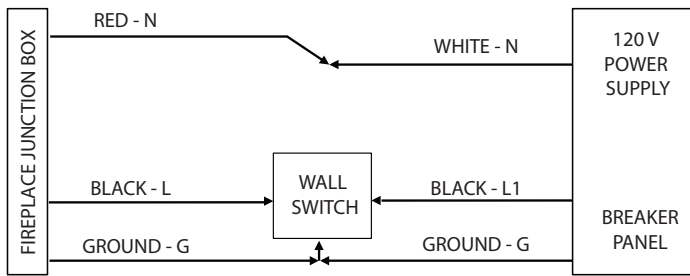



To install a 120 V wall switch:

1. Pull out the red, black, and green wires.
2. Connect the red-N wire from the fireplace to the neutral wire from the power supply panel.
3. Connect black-L from the fireplace to the line wire from the main power wall switch using a wire connector.
5. Connect the other end of L (black) to the L terminal of the main power wall switch.
6. Connect G (green) from the electric fireplace to the ground wire of the main power wall switch using a wire connector (not supplied).
7. Secure the two remaining ground wires (green) with a ground screw in the main switch wall box.
8. Insert all the wiring of the main power wall switch into the main switch wall box.
9. Insert all the wiring back into the electric fireplace and secure with a cable clamp.
10. Ensure all connections are tight.

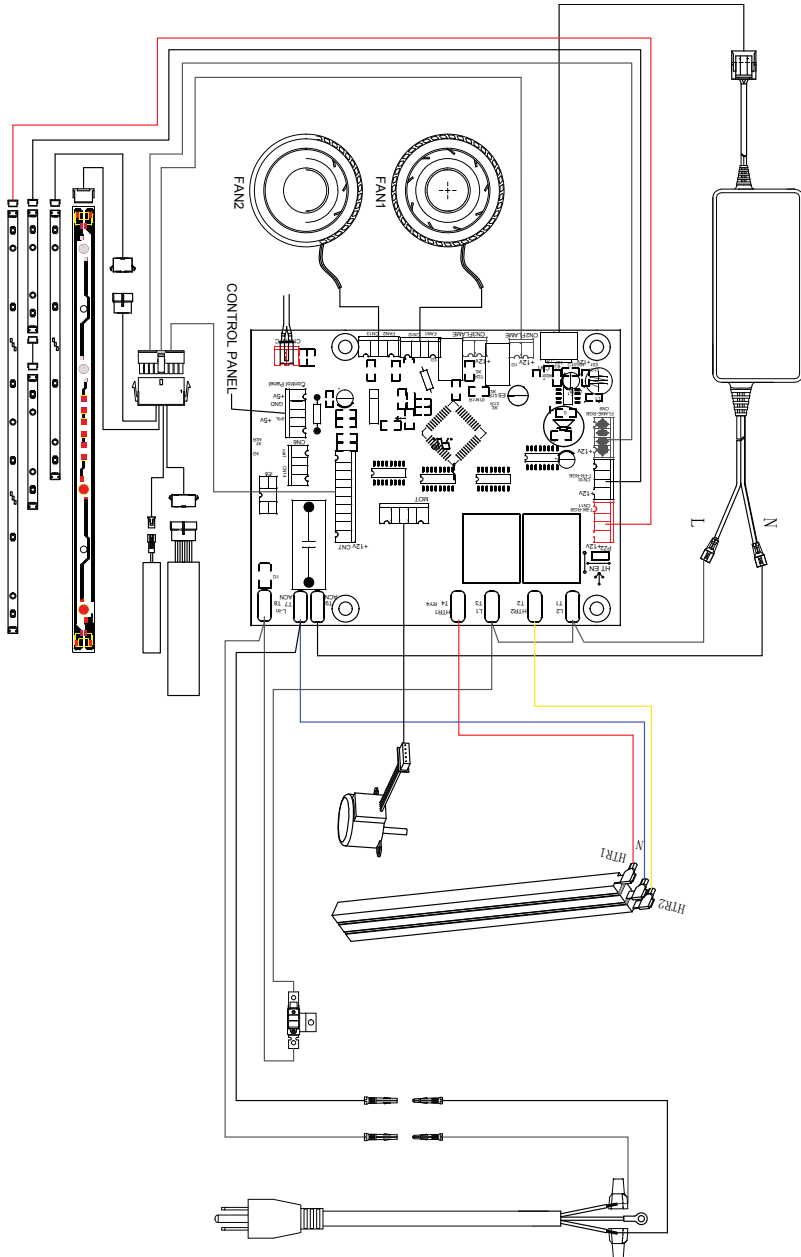

Operation

General

⚠ WARNING: The Revillusion™ Electric Fireplace must be installed properly before it is used.

⚠ CAUTION: Except for installation and cleaning described in this manual, an authorized service representative should perform any other servicing.

This fireplace operates with ComfortSaver™ technology, which automatically adjusts the fan speed and heater wattage to safely and precisely match the requirements of the room based on the thermostat setting.

The heater operates such that once the room reaches the set point, the fan and heater will continuously run at a low level to maintain the desired room temperature. If the temperature in the room rise significantly (e.g., sun coming through a window or a central furnace turns on) the heater will turn off and periodically turn back on to circulate the air around the unit until the room temperature drops and requires the heater to be constantly on again.

! NOTE: The fireplace retains heat after shutdown. When the heat is turned OFF, there is a 2-minute cool down period before the fan shuts off completely.

Touch Panel and Remote Controls

The touch panel controls for the Revillusion™ Electric Fireplace are located on the front panel. Touch an icon to activate. The selected setting displays on the left side of the panel.





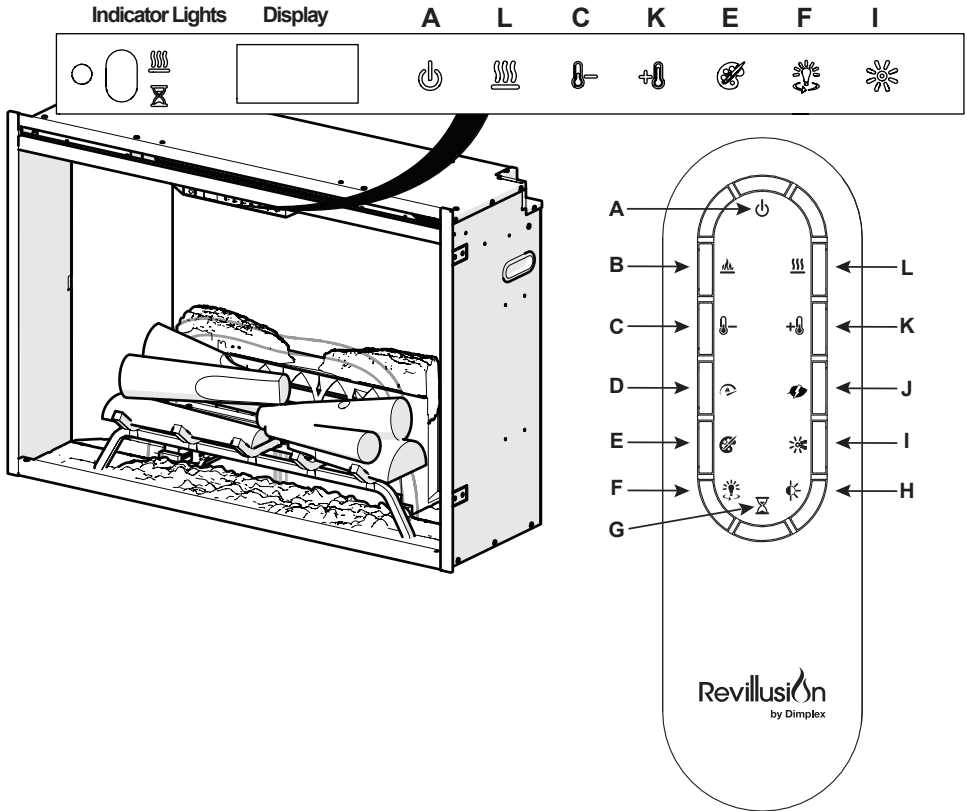

A multifunction remote control is included. The remote control has a range of approximately 30 ft (9 m). To operate correctly, the remote control must be pointed toward the front of the electric fireplace.

Operation















	Icon	Function	Description
A		Power/ Standby	Press to turn the unit on or put it in Standby mode. When the unit is turned back on, it will retain the previously used settings (except timer).
B		Flame	Press to light the log set and start the flame effect. Press again to turn feature off. ! NOTE: When the flame effect is off while the heat is on, the heat indicator light will remain illuminated to indicate the fireplace heat function is active.

Operation

	Icon	Function	Description
C		Temp Down	Press multiple times to lower the heater temperature in 1 °F (1 °C) increments. Displays current temperature; lowest temperature is 41 °F (5 °C). This feature is active whenever the heat is enabled.
D		Flame Speed	Press multiple times to toggle through the flame speeds (minimum, medium, maximum). The display will show the current speed number, F1, F2, F3, or F4.
E		Color Themes	Press multiple times to change the flame base colors from red to orange to off. (The first segment on the display will change from "r" to "o" to blank) This feature is active only when the flame effect is on.
F		360° Light	Press multiple times to change the LEDs on the sides and back of the unit from Midnight mode to white to yellow to red. (The middle segment on the display will change through 0 - 3 respectively. This feature is active only when the Flame is on.)
G		Timer	Press multiple times to change the sleeper timer in 0.5 hr increments from 0.5 hr to 8.0 hr before turning off. The remaining time on the sleep timer displays.
H		Light Sensor	Press to activate the ambient light sensor (ALS ON). Press again to turn the sensor off (ALS OFF). ! NOTE: The light sensor will adjust the brightness of the fireplace based on the ambient light in the room.
I		Brightness	Press to change the LED lights from High to Low. (The last segment on the display will change from "H" to "L") The Realog™ LEDs remain On when the heater is ON and the flame effect is Off. ! NOTE: When the Light Sensor is activated, High and Low flickering brightness settings are also available (Flashing "H" and "L").

Operation

	Icon	Function	Description
J		Heat Mode	Press the mutple time to toggle through the heat modes (Normal, Eco and Boost). Normal is indicated with a Nor on the display, ECO is indicate by an Eco on the display and Boost is indicate by a b20 on the display. In boost mode, a time is set initial for 20 minutes and the display will indicate b19, b18, etc as the time counts down. This is shown by pressing the heat mode button.
K		Temp Up	Press multiple time to raise the heater temperature in 1 °F (1 °C) increments. Displays current temperature; highest temperature is 99 °F (37 °C). This feature is active whenever the heat is enabled.
Change Fahrenheit (°F) to Celsius (°C)			Press both Temp+ () and Temp- () at the same time on the touch panel controls.
Heat Enable			Hold both Heat () and Temp- () on the touch panel controls for 2 seconds. Temperature displays on the screen. Hold both Heat () and Temp- () on the touch panel controls for 2 seconds, when temperature is adjusted "---" displays on the screen.
Heat Disable			
L		Heat	<ul style="list-style-type: none"> • Heat On Press to turn heat On (indicated by 1 short beep and the icon appearing on the display). Displays current heater temperature setting. Use the Temp Up/Down icon to change the heater temperature setting. • Heat Off Press to turn heat Off (indicated by 1 short beep). <p>! NOTE: After the heater is switched off, the fan will continue on for 2 minutes before turning off.</p>
Control Lock			Hold both Temp- () and Brightness (), on the unit, for 2 seconds to disable the touch panel controls (LOC).
Control Unlock			Hold both Temp- () and Brightness (), on the unit, for 2 seconds to enable the touch panel controls (UNL).



Maintenance

Resetting the Temperature Cutoff Switch

Should the heater overheat, an automatic cut out will turn the heater off and it will not come back on without being reset.

If the fireplace is installed with a plug, it can be reset by unplugging the fireplace, waiting 5 minutes and plugging back in.

If the fireplace is hard-wired, it can be reset by turning of the electrical breaker, waiting 5 minutes and turning the breaker back on.

⚠ CAUTION: If you need to continuously reset the heater, unplug the unit and call technical support at 1-888-346-7539.

General Maintenance

Inspect the electric fireplace regularly, depending upon conditions, and at a minimum yearly intervals. Remove the front glass and clean the logs, grate, and base as required.

⚠ WARNING: Disconnect power and allow heater to cool before attempting any maintenance or cleaning to reduce the risk of fire, electric shock, or injury.

⚠ CAUTION: Except for installation and cleaning described in this manual, an authorized service representative should perform any other servicing.

Clean Logs and Base

The electric fireplace set should not be operated with an accumulation of dust or dirt on or in the fireplace, as this can cause a build-up of heat and eventual damage.

Dust and vacuum the fireplace as needed. Use a damp cloth and a mild detergent to clean painted surfaces of the electric fireplace. Never use abrasive cleaners.



Maintenance

Clean Reflector Screen

The reflector screen is cleaned in the factory during the assembly operation. During shipment, installation, handling, etc., the screen may collect dust particles; these can be removed by dusting lightly with a clean dry cloth.

To remove fingerprints or other marks, clean the reflector screen damp cloth. Never use abrasive cleaners. Dry the screen completely with a lint-free cloth to prevent water spots.

Remote Battery Replacement

To replace the battery:

1. Remove the battery cover screw using a Philips screwdriver.
2. Slide the battery cover open.
3. Install a 3V (CR2032) lithium battery in the battery holder. The positive (+) side of the battery faces up.
4. Close the battery cover and secure the screw.



The used battery must be recycled or disposed of properly. Check with your Local Authority or Retailer for recycling advice in your area.

- ⚠ CAUTION:** When transporting or storing the heater and cord, keep in a dry place, free from excessive vibration and store so as to avoid damage.



Warranty

Two Year Limited Warranty

Products to which this limited warranty applies

This limited warranty applies to your newly purchased Dimplex Revillusion™ electric fireplace. This limited warranty applies only to purchases made in any province of Canada except for Yukon Territory, Nunavut, or Northwest Territories or in any of the 50 States of the USA (and the District of Columbia) except for Hawaii and Alaska. This limited warranty applies to the original purchaser of the product only and is not transferable.

Products excluded from this limited warranty

The fireplace is only covered for transportation to the end user and will not be covered if damage occurs during normal operation and/or maintenance. Products purchased in Yukon Territory, Nunavut, Northwest Territories, Hawaii, or Alaska are not covered by this limited warranty. Products purchased in these States, provinces, or territories are sold AS IS without warranty or condition of any kind (including, without limitation, any implied warranties or conditions of merchantability or fitness for a particular purpose) and the entire risk of as to the quality and performance of the products is with the purchaser, and in the event of a defect the purchaser assumes the entire cost of all necessary servicing or repair.

What this limited warranty covers and for how long

Products, other than fireplace surrounds (mantels) and trims, covered by this limited warranty have been tested and inspected prior to shipment. Subject to the provisions of this warranty, Glen Dimplex Americas warrants such products to be free from defects in material and workmanship for a period of 2 years from the date of the first purchase of such products as follows: (a) a repair or replacement warranty on defective products or parts, including in-home services, for the first year following the date of first purchase; and (b) thereafter, a

replacement of parts warranty on defective products and parts (with no in-home services) for the 1 year period commencing on the first anniversary of first purchase and ending on the second anniversary of the date of first purchase.

Dimplex fireplace surrounds (mantels) and trims covered by this limited warranty have been tested and inspected prior to shipment and, subject to the provisions of this warranty, Glen Dimplex Americas warrants such products to be free from defects in material and workmanship for a period of 1 year from the date of first purchase of such products. Warranty services do not include in-home services.

The limited 2 year warranty period for products other than fireplace surrounds (mantels) and trims and the limited 1 year warranty period for fireplace surrounds (mantels) and trims also applies to any implied warranties that may exist under applicable law. Some jurisdictions do not allow limitations on how long an implied warranty lasts, so the above limitation may not apply to the purchaser.

What this limited warranty does not cover

This limited warranty does not apply to products that have been repaired (except by Glen Dimplex Americas or its authorized service representatives) or otherwise altered. This limited warranty does further not apply to defects resulting from misuse, abuse, accident, neglect, incorrect installation, improper maintenance or handling, or operation with an incorrect power source.

What you must do to get service under this limited warranty

Defects must be brought to the attention of Glen Dimplex Americas Technical Service by contacting Dimplex at 1-888-346-7539 or 1367 Industrial Road, Cambridge Ontario, Canada N3H 4W3. Please have proof of purchase, catalogue/model and serial numbers available when calling. Limited warranty service requires a proof of purchase of the product.



Warranty

What Glen Dimplex Americas will do in the event of a defect

In the event a product or part covered by this limited warranty is proven to be defective in material or workmanship during (i) the 2 year limited warranty period for products other than fireplace surrounds (mantels) and trims, and (ii) the 1 year limited warranty period for surrounds (mantels) and trims, you have the following rights:

- Glen Dimplex Americas will in its sole discretion either repair or replace such defective product or part without charge. If Glen Dimplex Americas is unable to repair or replace such product or part, or if repair or replacement is not commercially practicable or cannot be timely made, Glen Dimplex Americas may, in lieu of repair or replacement, choose to refund the purchase price for such product or part.

- Limited warranty service will be performed solely by dealers or service agents of Glen Dimplex Americas authorized to provide limited warranty services.

- **For products (other than surrounds (mantels) and trims) for the period ending at midnight on the first anniversary of the date of first purchase**, Glen Dimplex Americas will in its sole discretion either repair or replace such defective product or part without charge. If Glen Dimplex Americas is unable to repair or replace such product or part, or if repair or replacement is not commercially practicable or cannot be timely made, Glen Dimplex Americas may, in lieu of repair or replacement, choose to refund the purchase price for such product or part. *This limited warranty entitles the purchaser to on-site or in-home warranty services.* Accordingly, Glen Dimplex Americas will be responsible for all labour and transportation costs associated with the repair or replacement of the product or part except as follows: (i) charges may be levied for travel costs incurred to travel to the purchaser's site where the product is located if the purchaser's site is beyond 30 miles (48 km) from the closest service depot of Dimplex's dealer or service agent; and (ii) the purchaser is solely responsible for providing clear access to all serviceable parts of the product.

- **For products (other than surrounds (mantels) and trims) for the period commencing at 12:01 a.m. on the day after the first anniversary of the first purchase and ending at midnight on the second anniversary of the date of first purchase**, this limited warranty entitles the purchaser to replacement parts only without charge. If Glen Dimplex Americas is unable to replace such part, or if replacement is not commercially practicable or cannot be timely made, Glen Dimplex Americas may, in lieu of replacement, choose to refund the purchase price for such part. The purchaser shall not be entitled to on-site or in-home warranty services. The purchaser shall be responsible for all expenses incurred for the removal of the part and installation of the replacement part including, without limitation, all shipping costs and transportation costs to and from the authorized dealer's or service agent's place of business and all labour costs. Such costs shall not be the responsibility of Dimplex.

- **For surrounds (mantels) and trims for the period ending at midnight on the first anniversary of the date of first purchase**, Glen Dimplex Americas will in its sole discretion either repair or replace such defective surrounds (mantels) and trims or part thereof without charge. If Glen Dimplex Americas is unable to repair or replace such product or part, or if repair or replacement is not commercially practicable or cannot be timely made, Glen Dimplex Americas may, in lieu of repair or replacement, choose to refund the purchase price for such product or part. The purchaser shall not be entitled to on-site or in-home services. The purchaser is responsible for all expenses incurred for repair or replacement of such product or part including, without limitation, all shipping costs and transportation costs to and from the authorized dealer's or service agent's business and all labour costs. Such costs shall not be the responsibility of Dimplex.

- On-site or in-home services not provided under this warranty may be performed at the purchaser's specific request and expense at Dimplex's then-current rates for such services.



Warranty

What Glen Dimplex Americas and its dealers and service agents are also not responsible for:

IN NO EVENT WILL GLEN DIMPLEX AMERICAS, OR ITS DIRECTORS, OFFICERS, OR AGENTS, BE LIABLE TO THE PURCHASER OR ANY THIRD PARTY. WHETHER IN CONTRACT, IN TORT, OR ON ANY OTHER BASIS, FOR ANY INDIRECT, SPECIAL, PUNITIVE, EXEMPLARY, CONSEQUENTIAL, OR INCIDENTAL LOSS, COST, OR DAMAGE ARISING OUT OF OR IN CONNECTION WITH THE SALE, MAINTENANCE, USE, OR INABILITY TO USE THE PRODUCT, EVEN IF GLEN DIMPLEX AMERICAS OR ITS DIRECTORS, OFFICERS, OR AGENTS HAVE BEEN ADVISED OF THE POSSIBILITY OF SUCH LOSSES, COSTS OR DAMAGES, OR IF SUCH LOSSES, COSTS, OR DAMAGES ARE FORESEEABLE. IN NO EVENT WILL GLEN

DIMPLEX AMERICAS, OR ITS OFFICERS, DIRECTORS, OR AGENTS BE LIABLE FOR ANY DIRECT LOSSES, COSTS, OR DAMAGES THAT EXCEED THE PURCHASE PRICE OF THE PRODUCT.

SOME JURISDICTIONS DO NOT ALLOW THE EXCLUSION OR LIMITATION OF INCIDENTAL OR CONSEQUENTIAL DAMAGES, SO THE ABOVE LIMITATION OR EXCLUSION MAY NOT APPLY TO THE PURCHASER.

How State and Provincial law apply

This limited warranty gives you specific legal rights, and you may also have other rights which vary from jurisdiction to jurisdiction. The provisions of the United Nations Convention on Contracts for the Sale of Goods shall not apply to this limited warranty or the sale of products covered by this limited warranty.



Technical Support

Technical and troubleshooting support, as well as a list of replacement parts can be found on:

www.dimplex.com/support

1-888-346-7539 | www.dimplex.com

In keeping with our policy of continuous product improvement, we reserve the right to make changes without notice.

GlenDimplex 
AMERICAS

Enhancing the moments that matter in life.

© 2022 Glen Dimplex Americas