

Smart Burner Collection

30" RC Smart Burner

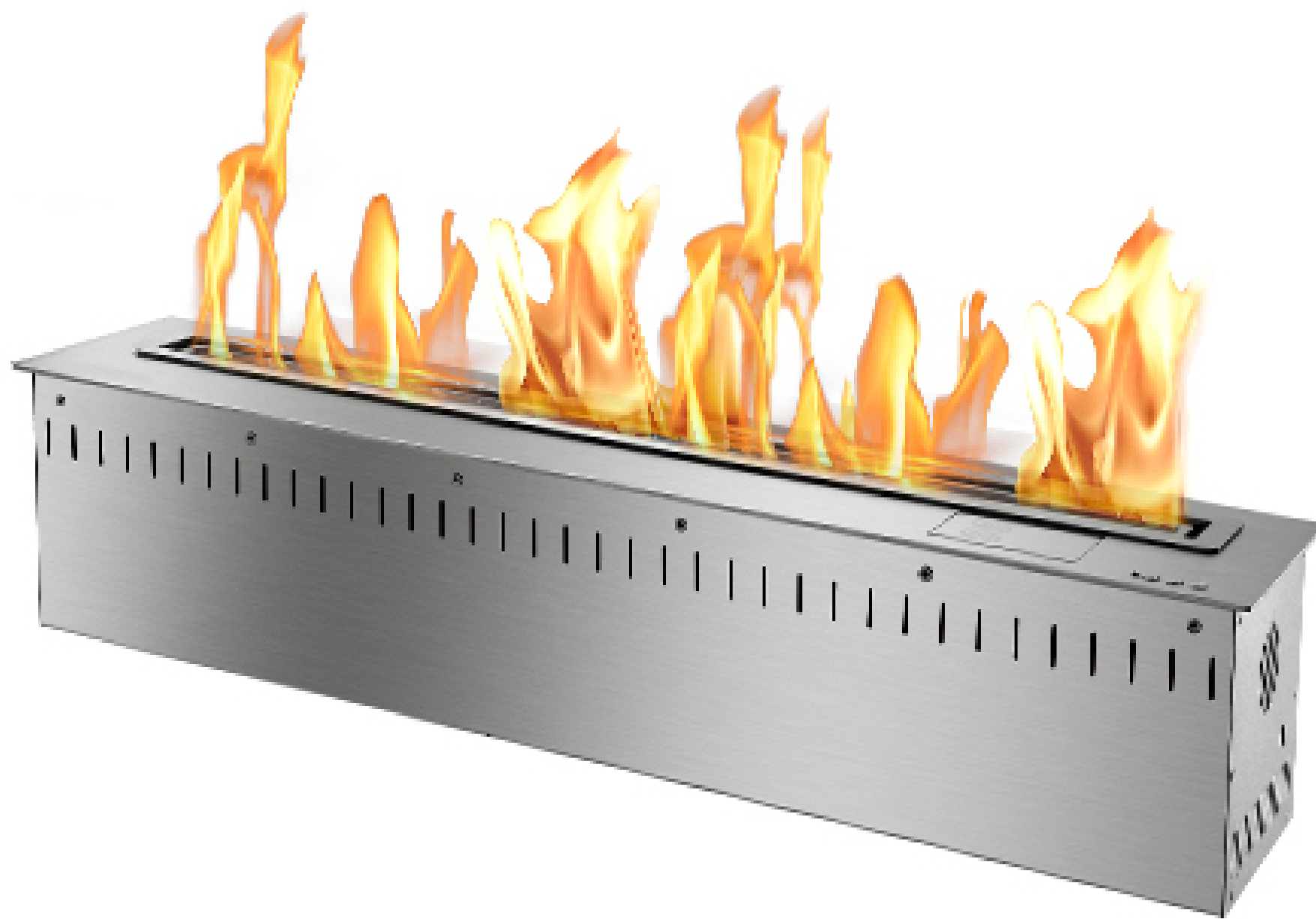

Black



Included Accessories



Lighting Rod



Lighter



Funnel

Smart Burner Collection

30" RC Smart Burner

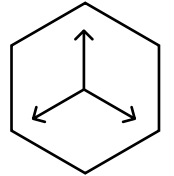
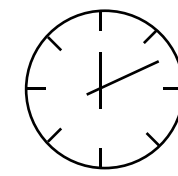
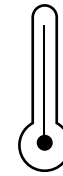
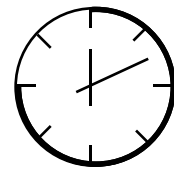
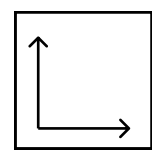
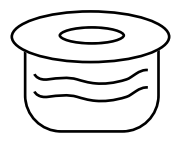
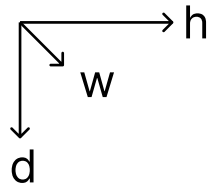
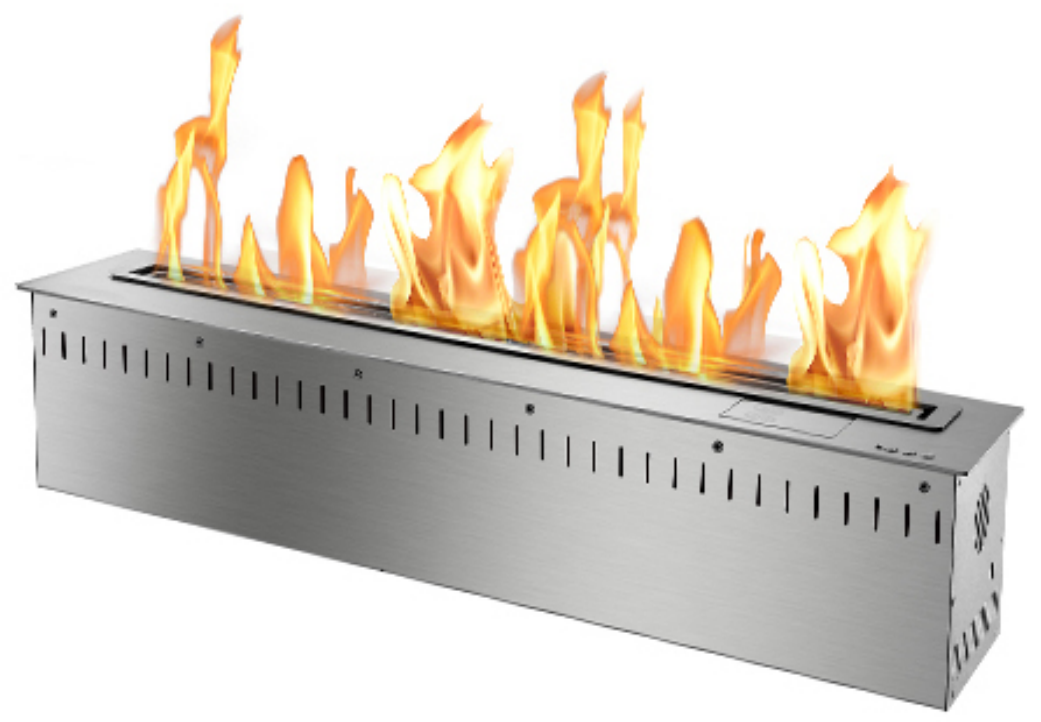

Dimensions H x W x D mm/in	Fuel Capacity	Heats on Average (indoors)	Fuel Consumption	Thermal Output Net (MAX)	Approx. Burn Time	Minimum Room Size (per burner)
168 x 762 x 193 6.6 x 30 x 7.6	8L	Over 73m ² [785 ft ²]	0.38L per hour	8,840 BTU - 20,600 BTU (6.0 kW.h)	21 hours	150 sq. ft.

Awards

2010 Winner Outdoor Hearth Products Vesta Awards

Application

Indoor & Outdoor

Burner Colour

Stainless Steel
 Black

Materials

304 Stainless Steel Construction
Insulated Bottom Tray

Remote Info

- 6 Adjustable Heat Settings
- Safety Sensors
- WiFi Control Smartphone App
- Automatic Fuel Refill System

Fuel Type

Bio Ethanol Fuel

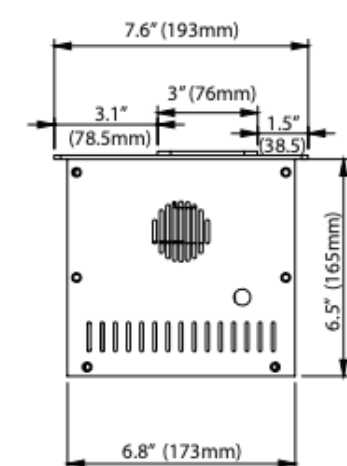
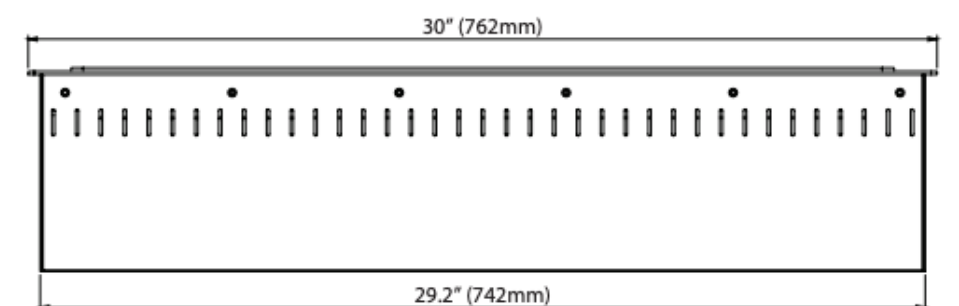
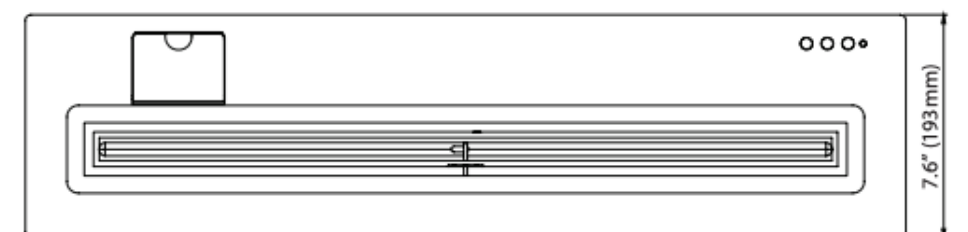

Inserting within a firebox setting:

The Bio Flame 30" RC BURNER can only be fitted into a non-combustible firebox that has minimum clearances of 38"W x 20"H x 15"D

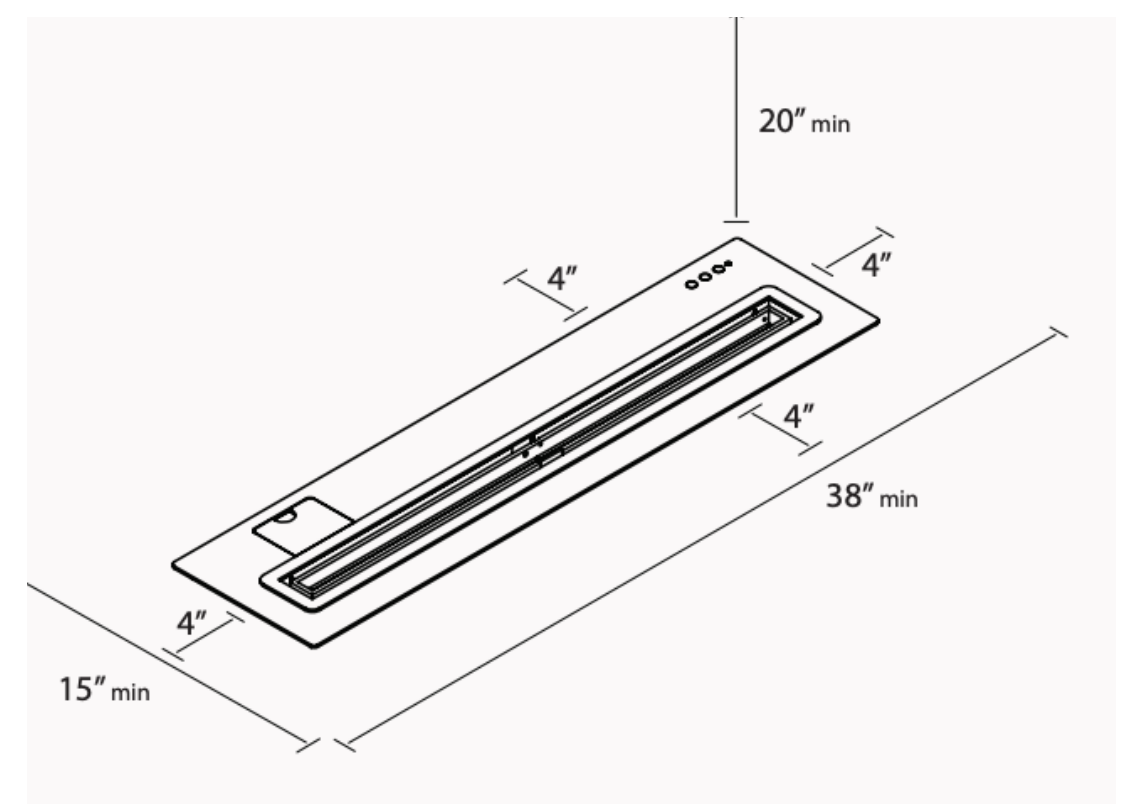

Global Compliance
All burners are UL Listed in accordance with ANSI/UL1370 in the USA and comply with the ACCC Safety Mandate for Australia.

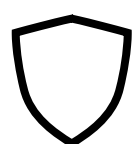

Lifetime Warranty

FOR MORE INFORMATION PLEASE REFERENCE THE CLEARANCE & INSTALLATION MANUAL

*Dimensions may vary by 2% (plus or minus) due to material attributes. Template not provided. The Bio Flame recommends using the actual fireplace or burner model when making final cut out

