

FOLD

BACK PAGE

FOLD

FRONT PAGE

## SAFETY TIPS

### DO'S

- Turn gas off at ignition knob after use.
- Check that burner is fully extinguished before disconnecting the gas cartridge.
- Remove the gas cartridge when not in use.
- Change the gas cartridge outside and away from people.
- Check the seals before connecting a new gas cartridge to the appliance.
- Always remove the cooker from the carry case prior to use.
- Keep children away from this appliance.
- Make sure there is adequate ventilation under the unit.
- Only operate on flat, horizontal surfaces.
- Use the cooker in cool places or in the shade. Keep the cartridge compartment out of direct sunlight.
- Leak test the regulator and cannister connection before use with a soapy water solution.
- Always check the gas cartridge position inside the compartment for leaks. If a leak occurs, turn off the supply and remove the gas cartridge.
- Only use when in attendance.

### CARE AND CLEANING

- The outside of the cooker can be wiped clean with a mild solution of dish washing detergent and finished off with a dry cloth. Do not use abrasive pads.
- We recommend the burner head be cleaned by gentle scrubbing with a dry brush at least annually. Ensure that the burner ports are free of any obstructions.
- Occasionally clean the point of the piezo plug with a hard brush or file.

### KEEP THIS APPLIANCE AWAY FROM COMBUSTIBLE MATERIALS

MINIMUM CLEARANCES: REAR 400mm - SIDE 400mm - TOP 1200mm

**Total Nominal gas consumption - 2 x 180g/h    Injector Size 0.54mm**

### DON'TS

- DO NOT use when not in attendance.
- DO NOT leave appliance running when not in attendance.
- DO NOT OPERATE IN AN ENCLOSED AREA.
- DO NOT operate in a boat, caravan or tent.
- DO NOT modify this appliance.
- DO NOT use the cooker in sand or on gravel surfaces.
- DO NOT move the cooker while it is lit.
- Avoid using the cooker in very windy conditions.
- DO NOT use a cooking pan that is larger than 26cm in diameter.
- DO NOT use appliance as a room heater, clothes drier or to ignite other fuel.
- DO NOT place articles on or against this appliance.
- DO NOT place chemicals or flammable materials, or spray aerosols near this appliance.
- DO NOT leave unattended.
- DO NOT use in carry case.

## TROUBLESHOOTING

Problem / Cause	No Ignition	No Burning	Unstable Flame	Uneven Flame	Slow Burning	Gas Smell	Stopped Working While in Use	Continued Burning	Solution
Lack of fuel	●	●			●		●		Replace cartridge
Piezo plug dirty	●								Clean spark point
Dirty burner	●	●	●	●	●				Clean burner
Cartridge misaligned	●	●	●		●	●			Reset correctly
Dirty burner or empty cartridge	●	●		●	●				Clean burner Replace cartridge
Faulty knob mechanism	●					●		●	Request for inspection/repair
Internal gas pressure too high							●		Cool down gas cartridge
Improper setting of spark point	●								Set spark point to 2-3mm away from burner

Due to continual development, specifications are subject to change without notice.

# Gasmate®

## TRAVELMATE II TWIN STOVE WITH HOTPLATE

Model No. CS6035

Twin over-pressure safety devices - enhanced safety devices which sense if pressure becomes too high. Firstly the cartridge is ejected and secondly the gas supply is shut off to the burner.

Vitreous enamel spill tray/top with flame protection ring.

Comes complete with Reversible Hotplate.

Cartridge lock lever and rotary piezo ignition.

Convenient storage and carry case.

Uses Gasmate bayonet cartridge per side (G4210 - sold separately).

Gas certified to Australian and New Zealand Standards.



BTU	MJ/h	GAS CONSUMPTION
2 x 8,500 BTU	2 x 9MJ/h	2 x 180g/h



### WARNING - USE OUTDOORS ONLY

ONLY USE IN WELL VENTILATED AREAS.

CARBON MONOXIDE HAZARD - USING THIS APPLIANCE IN AN ENCLOSED SPACE MAY CAUSE DEATH. DO NOT USE IN CARAVANS, TENTS, MARINE CRAFT, CARS, MOBILE HOMES OR SIMILAR LOCATIONS.

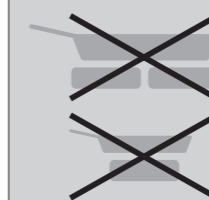

### NOT FOR COMMERCIAL USE

**DO NOT** USE MULTIPLE APPLIANCES TO HEAT A SINGLE COOKING DEVICE

**DO NOT** USE OVERSIZED COOKING DEVICES (MAXIMUM 26CM DIAMETER)

**DO NOT** USE AS A SPACE HEATER OR FOR ANY PURPOSE OTHER THAN COOKING

**DURING USE AVOID BOIL OVER AND SPILLAGE**

**Important: Retain these instructions for future use.**

Gasmate® is a registered trademark of:  
Sitro Group Australia Pty Ltd    www.gasmate.com.au  
Aber Living, N.Z    www.gasmate.co.nz

03932 01/20

FOLD

FOLD



## WARNING!

NEVER USE A POT OR PAN OVER 26CM DIAMETER.  
USE OUTDOORS ONLY.

## IMPORTANT

Read these instructions for use carefully. Familiarise yourself with the appliance before connecting it to its gas container. Keep these instructions for future reference.

This appliance shall only be used with a Butane gas cartridge certified to EN 417 or equivalent.

IT MAY BE HAZARDOUS TO ATTEMPT TO FIT OTHER TYPES OF GAS CONTAINERS.

\* REMOVE ANY TRANSIT PROTECTION MATERIAL.

## PARTS LIST

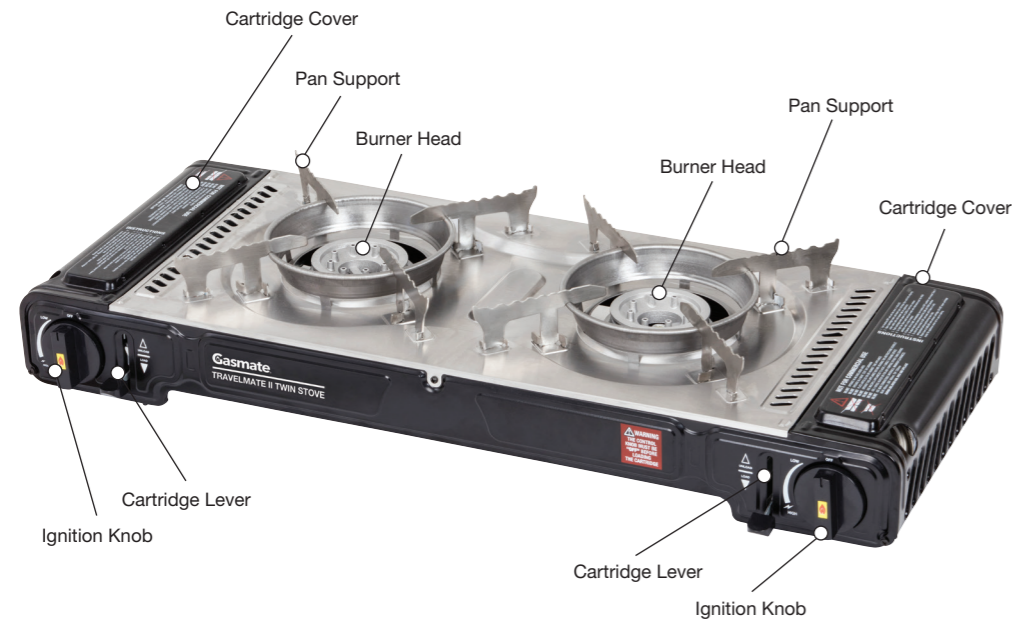

## TWIN OVER-PRESSURE SAFETY DEVICES

When used in **extreme conditions** or if the **Instructions are not adhered to**, the internal pressure of the gas cartridge may rise to a hazardous pressure.

The 1st over-pressure safety device will activate and eject the gas cartridge. To reset after activation remove the gas cartridge and hold it vertically with the nozzle facing upwards away from your face. **Check the cartridge temperature and if it is warm or hot place it in an area to cool down to ambient temperature.** Once cool carefully depress the nozzle momentarily to release the high pressure gas, ensuring that no heat source or naked flame is in the vicinity.

**If for any reason the 1st stage ejection does not activate** the 2nd over-pressure safety device will shut off the gas supply to the burner, to reset after activation remove the gas cartridge as described above and release the pressure as indicated. On the inner side of the regulator locate the red button and press it in one smooth action (Fig. 6).

**It is strongly recommended and essential** to consider what has caused the pressure within the cartridge to rise beyond the safe operating limit and rethink how the appliance is being used. **“Are the Instructions being followed?”**

If you have any concerns email our Customer Service centre.

## OPERATING INSTRUCTIONS

### Inserting the Gas Cartridge

1. Turn the Ignition Knob to 'OFF' and set the Cartridge Lever to 'UNLOAD' (Fig. 1).  
Note: If the Ignition Knob is not in the 'OFF' position the gas cartridge cannot be loaded.
2. Open the Cartridge Cover: Slide the gas cartridge, top end first and with its notch up, into the compartment. Align cartridge collar notch with the red locator tab on the appliance (Fig. 2).
3. Push the Cartridge Lever down to 'LOAD' in one firm motion (Fig. 3).

### Lighting the Stove

1. Push and turn the knob anti-clockwise past the '⚡' position until a click is heard (Fig. 4).
2. If the burner fails to light, immediately turn the Ignition Knob to 'OFF' position and repeat Step 1.

### To Adjust Heat

Flame can be controlled by turning the Ignition Knob between the 'HIGH' and 'LOW' position.

### To Shut Off

1. Turn the Ignition Knob to 'OFF' to shut off fuel supply (Fig. 5). Wait until the flame is fully extinguished before performing the next step.
2. Raise the Cartridge Lever to 'UNLOAD' and remove the gas cartridge from the compartment.  
Note: Do not leave the gas cartridge inside the unit when not in use or storing the product.

### After Use

1. Replace the cap on the gas cartridge after removing it from the unit. Store upright in a cool dry place.
2. Make sure the burner is cool to touch before packing unit away.
3. **DO NOT** store the cartridge near other flammables.  
**DO NOT** store the cartridge near sources of heat or direct sunlight.  
**DO NOT** store in the glove compartment or boot of your car.  
**DO NOT** puncture or incinerate empty cartridges.

Check that the seals between the appliance and the gas container are in place and in good condition before connecting the gas container.

- Leak test the regulator and cannister connection before use with a soapy water solution.
- DO NOT use this appliance if it has damaged or worn seals.
- DO NOT use this appliance if it is leaking, damaged or does not operate properly.
- The cartridge may be disconnected even if some gas remains.
- Check the contents by shaking and listening for the liquid gas.

Gas containers shall only be changed in a well ventilated location, preferably outside, away from people and way from sources of ignition; such as naked flames, pilot flames, electric heaters/equipment.

If there is a leak on your appliance (smell of gas) and you cannot stop the gas flow, remove the appliance to a well ventilated location away from any ignition source. Only check for leaks outdoors using soapy water. DO NOT try to detect leaks using a flame.

This appliance must only be serviced by an authorised person.

NOTE: The stove efficiency will be reduced in strong windy conditions. In this case use outdoors in wind protected areas.



## WARNING

THE OPENINGS AT THE BASE OF THE BURNER PROVIDE AIR FOR COMBUSTION, THEY SHOULD NEVER BE OBSTRUCTED. IF THE FLAME BECOMES SIGNIFICANTLY ORANGE CHECK THESE OPENINGS FOR A BLOCKAGE. IF THE APPLIANCE CANNOT BE ADJUSTED TO PERFORM CORRECTLY IT SHOULD NOT BE USED UNTIL SERVICED OR REPAIRED.

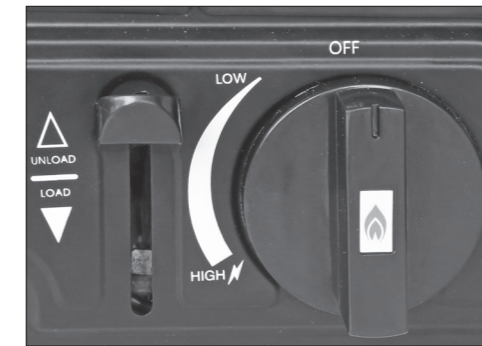

Fig. 1

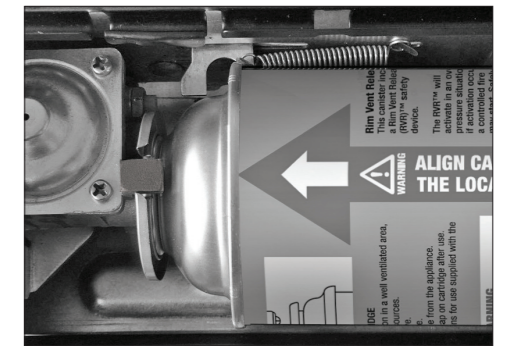

Fig. 2



Fig. 3

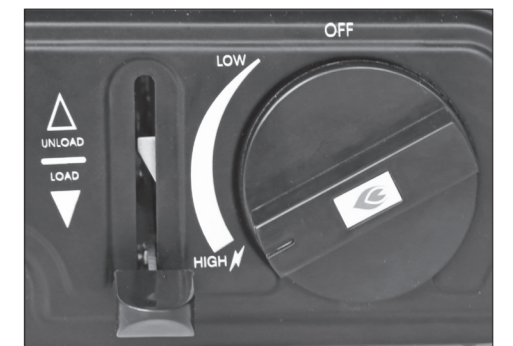

Fig. 4

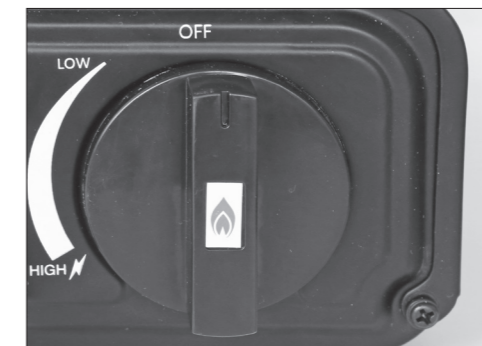

Fig. 5

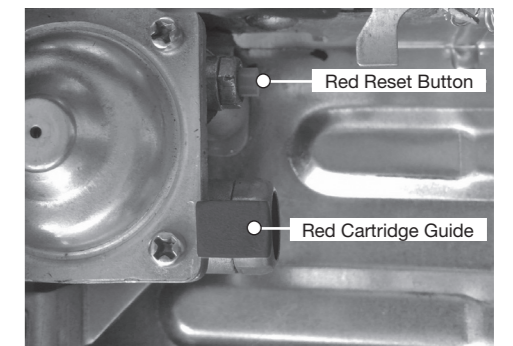

Fig. 6



**WARNING: IF THE CARTRIDGE IS WARM / HOT STOP COOKING IMMEDIATELY • YOUR COOKING METHOD IS DANGEROUS • YOU MUST RE-ASSESS THE COOKING METHOD**