



Troubleshooting Guide

IntelliFire Plus Ignition System

**For authorized gas technicians use
only.*

IntelliFire Plus Troubleshooting Guide

Table of Contents

Introduction.....	3
Tools and Instruments.....	5
System Basics.....	6
Problem Scenario #1.....	13
Problem: Pilot won't light, no noise and no spark	
Problem Scenario #2.....	18
Problem: The module makes noise, but no spark	
Problem Scenario #3.....	21
Problem: Pilot sparks, but pilot will not light.	
Problem Scenario #4.....	24
Problem: Pilot lights, but continues to spark and main burner will not ignite.	
Problem Scenario #5.....	27
Problem: Pilot lights, stops sparking, and pilot remains lit. Burner will not light	
Problem Scenario #6.....	29
Problem: Low pressure reading on outlet side when set to high flame position.	
Diagnostic Codes.....	31
System Checklist	32

Use of this Guide

This troubleshooting guide provides an overview of the IntelliFire Plus system, reviews problem scenarios, provides a system's checklist and frequently asked questions.

The purpose of this guides is to provide a tool:

- To educate
- To aid in proper diagnosis for accurate parts replacement
- To reduce multiple service calls
- To gather necessary information to assist with proper diagnosis of problems

Qualified Service Technicians Only

This troubleshooting guide is for use by qualified service technicians only. It is designed to help qualified service technicians troubleshoot gas fireplace with IntelliFire Plus ignition systems.

Warning: Do not attempt to service appliances which you are not qualified to service. Service attempted by unqualified persons could result in risk of bodily injury and property damage.

Obligation of Service Professionals

Service technicians must be attentive to appropriate codes, understand and follow manufacturer's installation instructions, and use the proper parts and materials when servicing and installing gas appliances. One of the most important tools you bring to a service call is the installation manual.

Communicating with the Owner

Ask the owner a few simple questions prior to service:

- Has What are the symptoms?
- When does the problem occur?
- How long has the appliance been installed?
- Model Number
- Serial Number
- Operating Gas—LP or NG

Technical Assistance—Distributors & Dealers

Heat & Glo—877-228-5012

Heatilator—877-943-2848

Quadrafire—866-804-7783

For technical assistance call the appropriate branded number, which is dedicated to trade channel partners. Please do not give these numbers to homeowners, builders, etc. Be prepared to provide the following information:

- Fireplace model and serial number
- Previous service history if with previous HHT reference number, if any
- Detailed problem description

Technical Service will assign a reference number to troubleshooting calls when information is provided. To ensure a more timely repair and processing of claims involving multiple service calls, HHT expects a dealer to contact Technical Service after 2 failed attempts to repair a product. A completed checklist may be requested to assist with diagnosis.

07722709 01:37 PM CDT via VSI-FAX Page 1 of 1 #3544896

 HEARTH & HOME technologies	Claim System Acknowledgement
[HHT Cust Number] FHH-RICHMOND, VA 2227 DABNEY RD. RICHMOND, VA 23230 US	Reference Number: 1369359 Date Entered: 09-30-08 Technician: Curt Marx Claim Status: Open Approval Status: Approved

Recording the reference number improves communication between dealer and HHT. This number is also used when and if a warranty claim is filed for the service call.

You will need the following tools and equipment to execute troubleshooting outlined in this guide.

Required Tools:

- Open end wrenchs, 3/8", 7/16", 9/16"
- Adjustable end wrenches: 8" and 10"
- 1/4", 5/16" nut driver
- Straight screwdrivers (including small 1/8" blade for pressure check and stubby straight.
- Phillips screwdrivers #1 and #2 and stubby Phillips
- Plastic straight screwdriver (Rhino style)
- Electrical pliers
- Needle nose pliers
- Flashlight
- Numbered drill index
- T-20 tamper resistant Torx bit HHT part #810-225
- Soft-bristle toothbrush
- Soft 1" paint brush
- Electric drill 1/4" - 3/8"

Required Testing Equipment:

- Multi-meter (must measure millivolts)
- Manometer
- Leak detection fluid
- 2 to 4, 12"-14" jumper wires
- "flame stick" lighter wand

Miscellaneous:

- Smoke Match
- Drop Cloth/Tarp
- Glass cleaner/towels
- Vacuum
- Personal Protection Equipment

ALL TOOLS AND TEST EQUIPMENT SHOULD BE PROPERLY STORED AND MAINTAINED.

The IntelliFire Plus IPI (intermittent pilot ignition) Ignition System and Wireless Controls is a total control system, from the components under the fireplace to the remote control in your hand. HHT Hearthville offers Sales and Product Knowledge Training modules as companions to this troubleshooting guide. Taking Hearthville modules is recommended. HHT dealers and distributors can go to www.hearthville.com.

Ignition Control Components

- Ignition Control Box (includes receiver for wireless remotes)
- 6 DC Volt Transformer
- Wiring Harness
- IPI Valve with Stepper Motor
- IPI pilot assembly
- Battery Backup *

Wireless Controls*

- RC100, RC200 & RC300 wireless controls w/ batteries

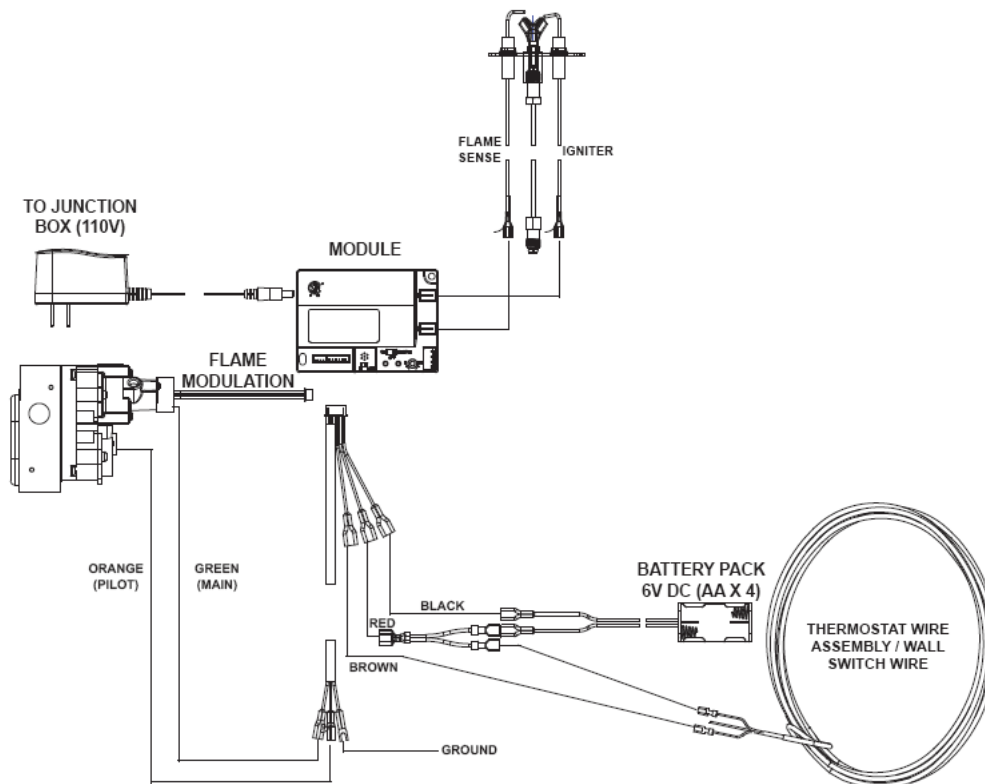

* This guide assumes the wireless controls and battery backup components have been eliminated and “unlearned” from the system for purposes of troubleshooting the ignition system.

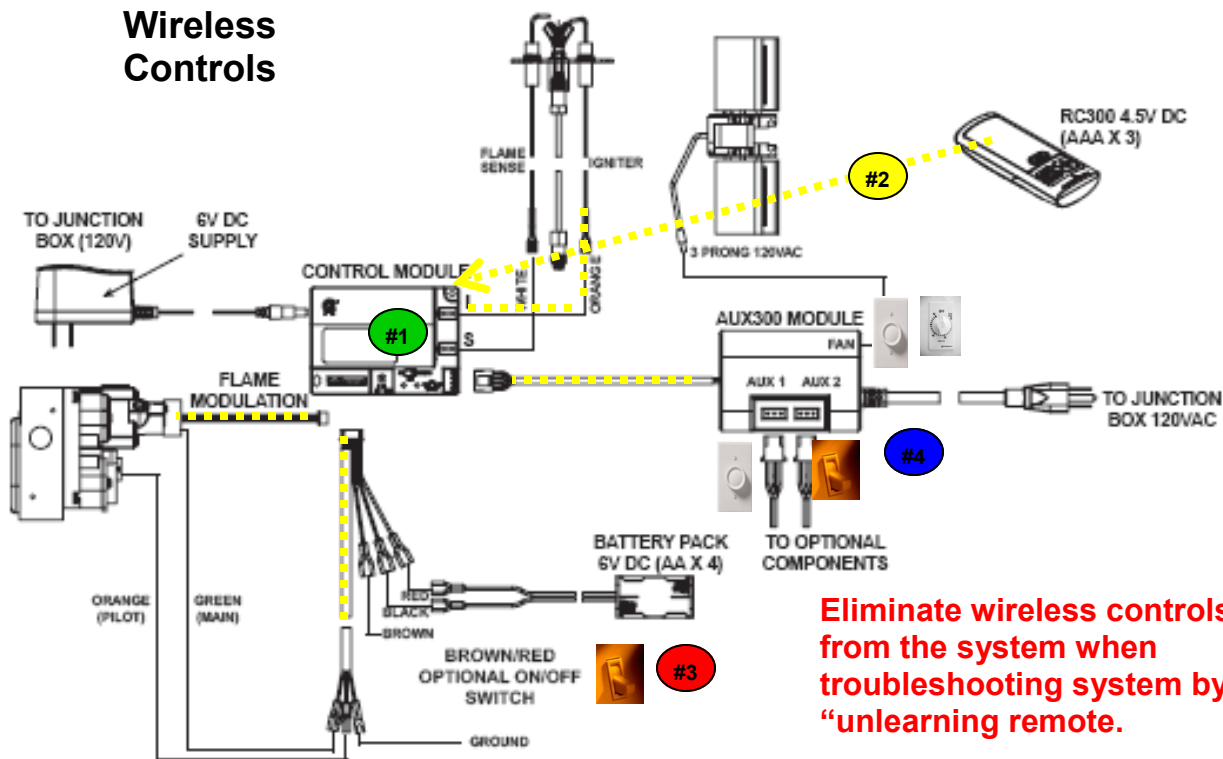

Eliminate wireless controls from the system when troubleshooting system by “unlearning remote.”

#1 ON/OFF/REMOTE switch on module must be in REMOTE position for wireless controls to operate the remote and optional wired wall switch.

#2 The wireless control and receiver (housed in the control module) communicate to and from each component via radio frequency. They must remain within 30 feet of each other.

For the RC300, when in thermostat mode, transmission of information happens every 60 seconds. For optimum operation you may need to try different locations for the wireless control when in thermostat mode.

#3 If a wired wall switch is installed and in the ON position, it will override the commands of the wireless controls. Must be OFF to use remote.

From the wireless control commands, data signals are transmitted to the AUX200 & 300 modules. Voltage is sent to igniter, stepper motor, pilot regulator and main burner regulator.

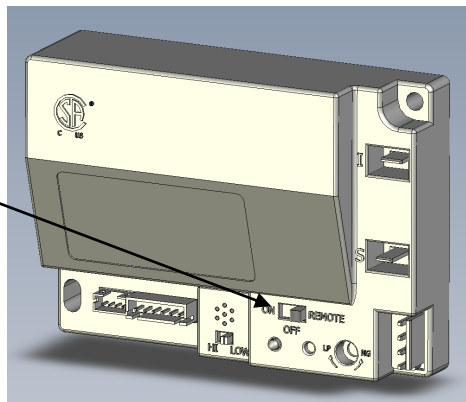

#4 AUX200 & 300 module controls the FAN and incorporates timer and rheostat functionality.

AUX300 module also controls 2 auxiliary functions. AUX1 offers high/med/low settings

AUX2 offers ON/OFF control.

**IPI Ignition Control Module (see labeled diagram below)
w/ remote receiver**

1—Igniter sparks when commanded via wall switch, wireless control or control module switch to turn on main burner. Voltage through the wire to igniter on pilot assembly creates spark to ignite gas released to pilot assembly.

2—Sensor rod acknowledges pilot flame is present before releasing gas to the main burner for ignition. When a pilot flame engulfs the sensor rod it conducts electrical current from the sensor through the flame to ground in one direction, which acts as a switch to the control module at this connection. Gas flows to the main burner 4-8 seconds after continuity happens via flame rectification.

3—Sends commands from the wireless controls to the AUX200/300 modules, controlling fan kits (AUX200&300) and 2 additional auxiliary functions (AUX300).

4—Fuel setting is factory set, but must be adjusted if fireplace is converted. Switch does not regulate gas pressure to valve, but it does allow for appropriate variability settings for flame modulation. Take care when adjusting this switch. We recommend using a small, straight ceramic/anti-static screwdriver, which is supplied by electrical supply companies.

5—Learn Button is used to program up to 3 wireless controls to fireplace. Instructions provided in controls instructions.

6—Diagnostic light assists with troubleshooting. Error code chart provided page 30.

7—ON/OFF/REMOTE Switch

8—Manual HI/LOW flame switch is operable with RC100 use only with ON/OFF/REMOTE switch in REMOTE setting. Modulates 2 flame settings.

9—Power from battery pack, wall switch connection, and connection to valve pilot and burner regulators.

10—Flame Modulation (stepper motor) connection

11—Power supply connection to 6 Volt DC adapter, plugged into the junction box.

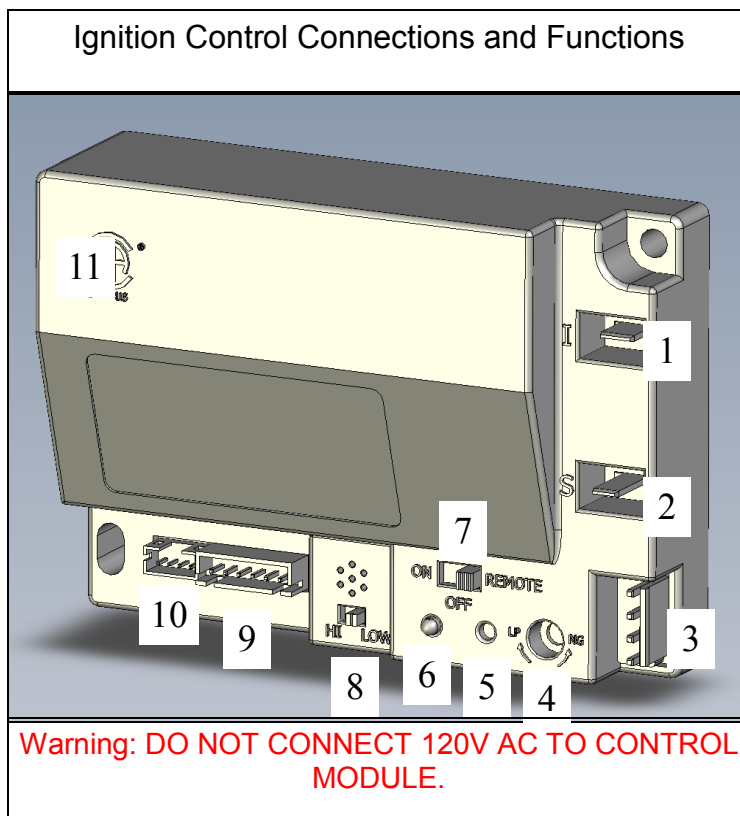

IPI Gas Valve w/ Stepper Motor

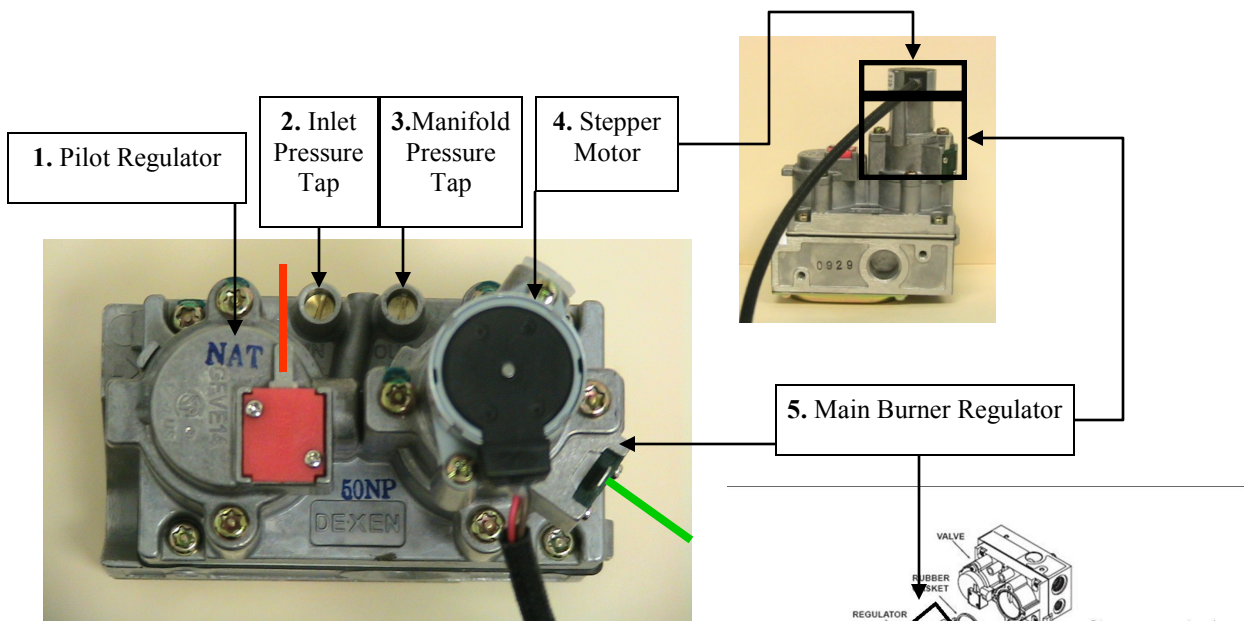

1. **Pilot regulator** is stamped as Nat or LP, designating the factory setting. If converted the main burner regulator has fuel type stamped along the side, indicating the conversion. The **orange** wire from the ipi ignition module is connected to the pilot regulator.
2. Test the **inlet pressure** at this tap.
3. Test the **manifold pressure** at this tap.
4. The **stepper motor** is not a replaceable as a separate part, only available assembled to the main burner regulator. It's function is to modulate the flame. There is no reliable field voltage test for the stepper motor. Valve will function without functioning stepper motor, but flame will not modulate. ***** Note: An audible noise will be heard when the stepper motor is modulating flame during flame adjustment, in thermostat mode and when flame is turned off.*****
5. **Main burner regulator** is changed when unit is converted and comes with stepper motor installed. The **green** wire from the ipi ignition module is connected to the main burner regulator.

- Optimum appliance performance requires proper input pressures.
- Gas line sizing requirements will be determined in ANSI Z223.1 National Fuel Gas Code in the USA and CAN/CGA B149 in Canada.
- Pressure requirements are:

Gas Pressure	Natural Gas	Propane
Minimum inlet pressure	5.0 in. w.c.	11.0 in. w.c.
Maximum inlet pressure	10.0 in. w.c.	13.0 in. w.c.
Manifold pressure	3.5 in. w.c.	10.0 in. w.c.

WARNING! Risk of Fire or Explosion! High pressure will damage valve. Low pressure may cause explosion.

- Verify inlet pressures. Verify minimum pressures when other household gas appliances are operating.
- Install regulator upstream of valve if line pressure is greater than 1/2 psig.

Important gas supply information provided in HHT gas fireplace Owner's Manual, Installation and Operation.

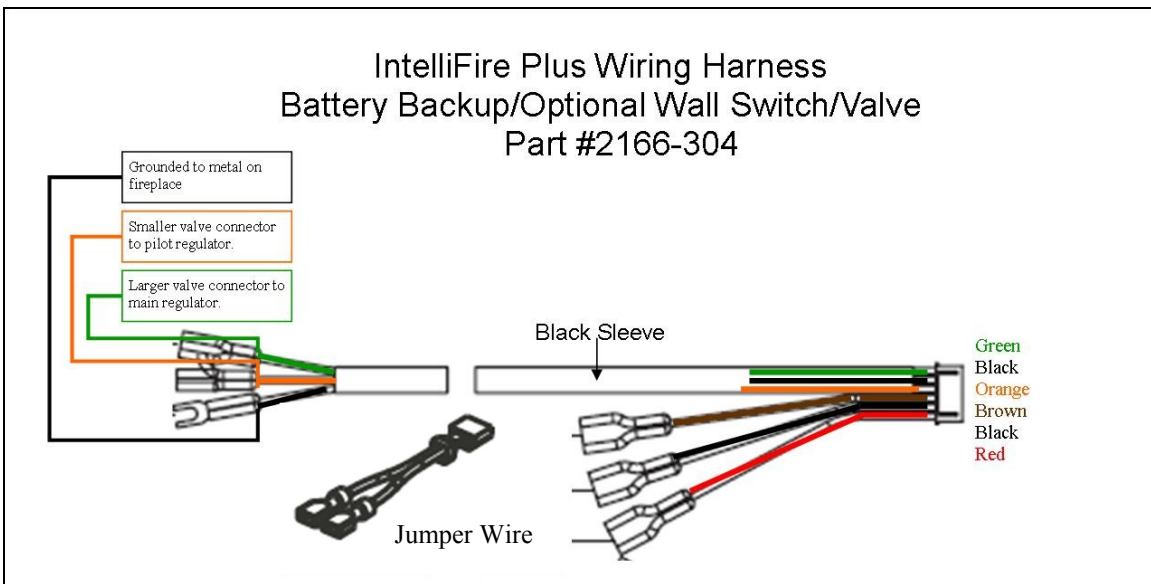
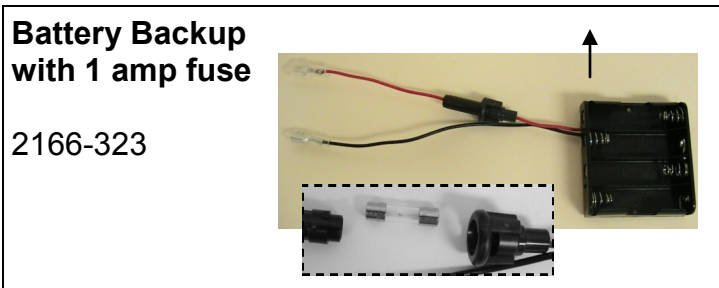
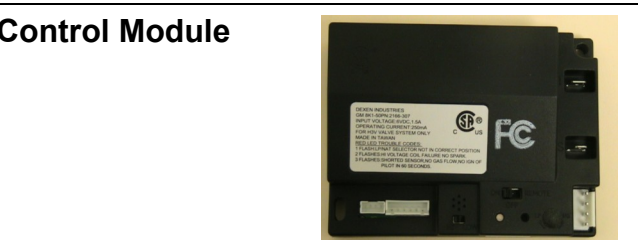
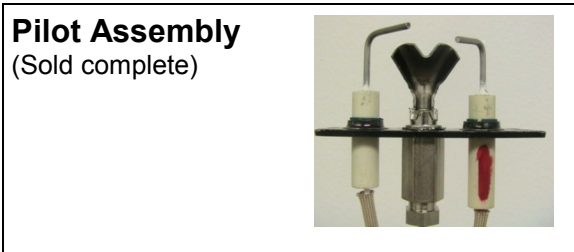
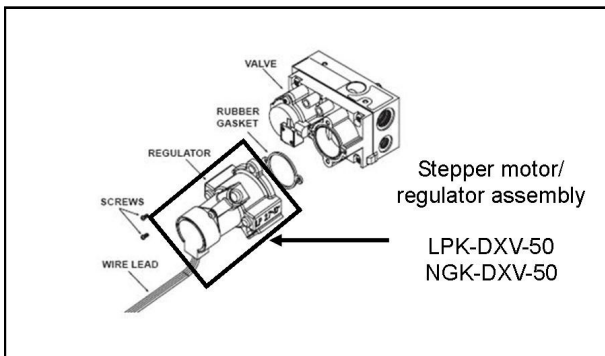
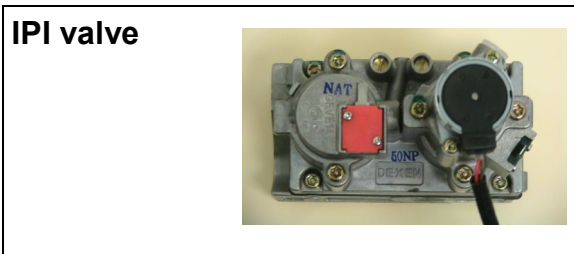

* Refer to specific unit service parts list for correct part number.



Main Components of Wireless Controls
 RC100—Wall mounted control w/ cover plate.

RC200—Control, docking station and AUX200 module to control fan kit.

RC300—Control, docking station and AUX300 module to control fan kit and 2 auxiliary functions.



AUX200—Powers and controls voltage for variable fan speeds.

AUX300—Powers and controls voltage for variable fan speeds, high/medium/low (AUX1) and on & off (AUX2) .

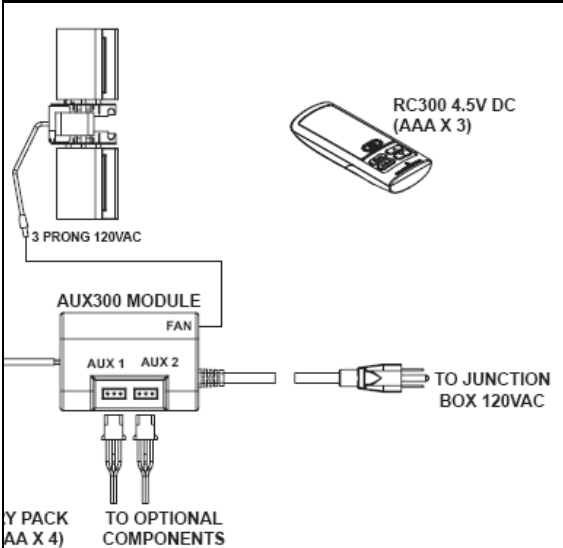
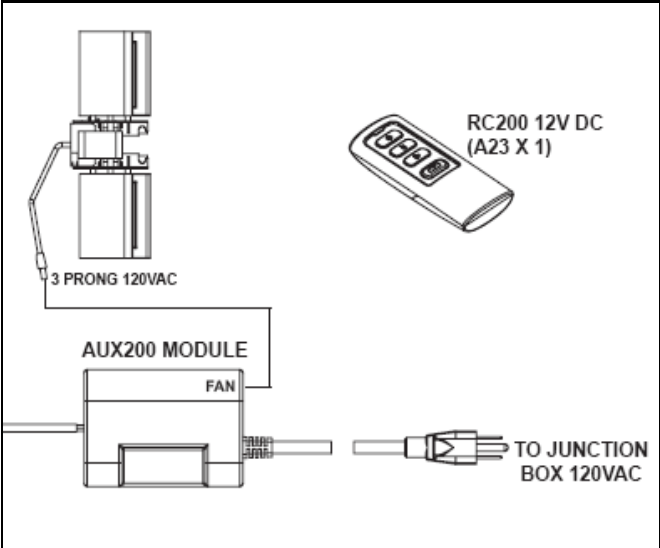

Diagnose Root Cause

Going into a service call with a conclusion prior to checking the complete system can lead to replacing unnecessary parts, multiple service calls and wasted time and money for you, the customer and HHT. When servicing any HHT product the complete system needs to be checked to diagnose the **cause**.

Using the checklist to document the diagnostic information will...

- Instills consumer confidence
- Consistent service performance
- Provides unit history for future service calls
- Improves communication when seeking technical assistance

Areas to be checked:

- Visual Inspection for proper installation and condition of installation
- Electrical
- Gas Supply



Area/System	Proper Readings/Reference Info/Items to be checked:	<input checked="" type="checkbox"/>
<i>Refer to appropriate installation and operation manual for all areas</i>		
1. Condition		
<div style="position: absolute; top: -40px; left: -40px; background-color: black; color: white; padding: 5px; transform: rotate(-15deg); font-weight: bold; font-size: 1.2em;">Example</div>	Does the installation meet venting requirements for... rise to run ratio? vent cap type? vent cap location? venting size?	
b. Gas Supply Components	Gas line sizing and components must meet ANSI Z223.1 and local codes requirements. Supply pipe must be ½” minimum. Note all appliances supplied inline Locate all shut off valves. What po	

Complete system checklist is provided at the back of the guide. Sections of the system checklist are duplicated and used with specific problem scenarios.

HHT Technical Service may request a complete checklist for units in the field that have not been repaired after 2 or more service calls.

Problem: Pilot wont' light, no noise and no spark*

Go to page 29 to familiarize yourself with module diagnostic codes.

The problem may be:

1. Loose or improper wiring. System not grounded.
2. Control Module selector switch NOT set properly.
3. No power to junction box
4. No power from junction box
5. No power from 6Volt DC transformer
6. Wired wall switch not wired properly.
7. LP/NG switch on module damaged or not fully engaged into LP or NG setting.
8. Faulty module

**** Notice ****

- Disconnect power to the system prior to disconnecting any components by switching the ON/OFF/REMOTE module switch to the OFF position. Interrupting power to stepper motor can freeze motor position (see page 29).
- It is not recommended to operate the ignition control module with disconnected wire connections. A short could cause permanent damage.
- Introducing the pilot sensor rod with a false flame, such as from a flame stick, will cause the module to go into lock-out mode. This is due to a

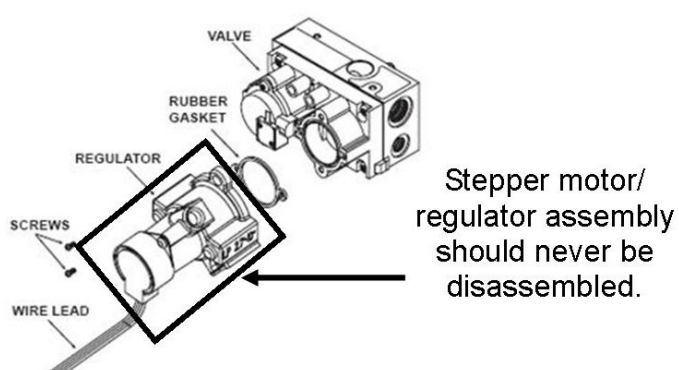
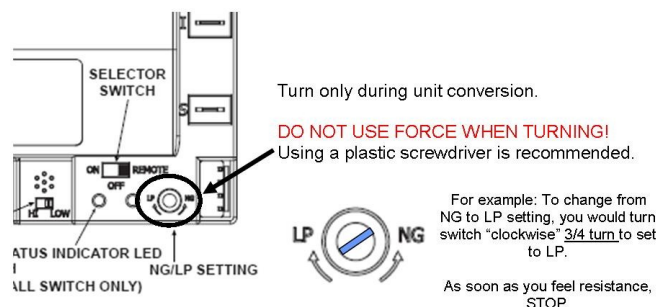
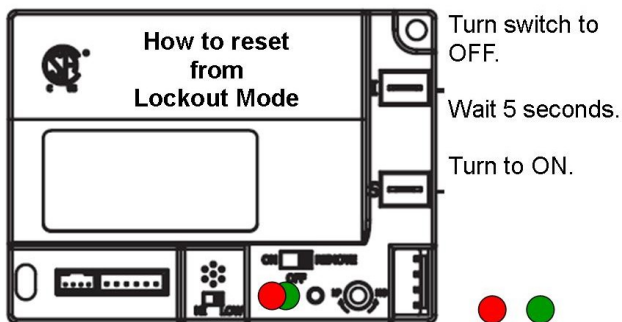

* Troubleshooting assumes the wireless controls & battery backup have been eliminated from the system. To do this the remote must be "unlearned" from the system. .

Problem: Pilot won't light, no noise and no spark *

1. Loose or improper wiring. System not grounded.
2. Control Module selector switch NOT set properly.

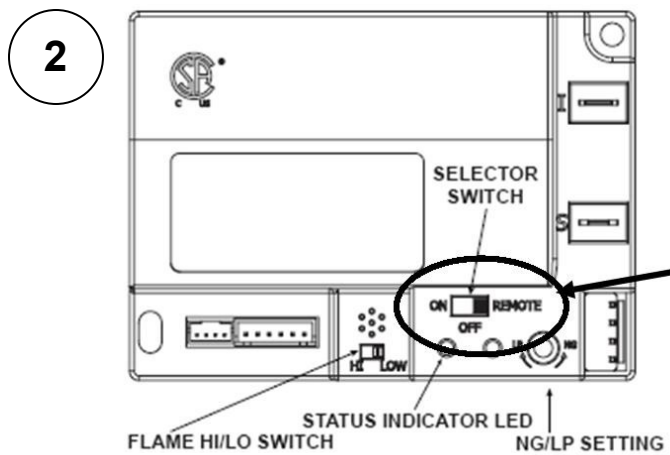
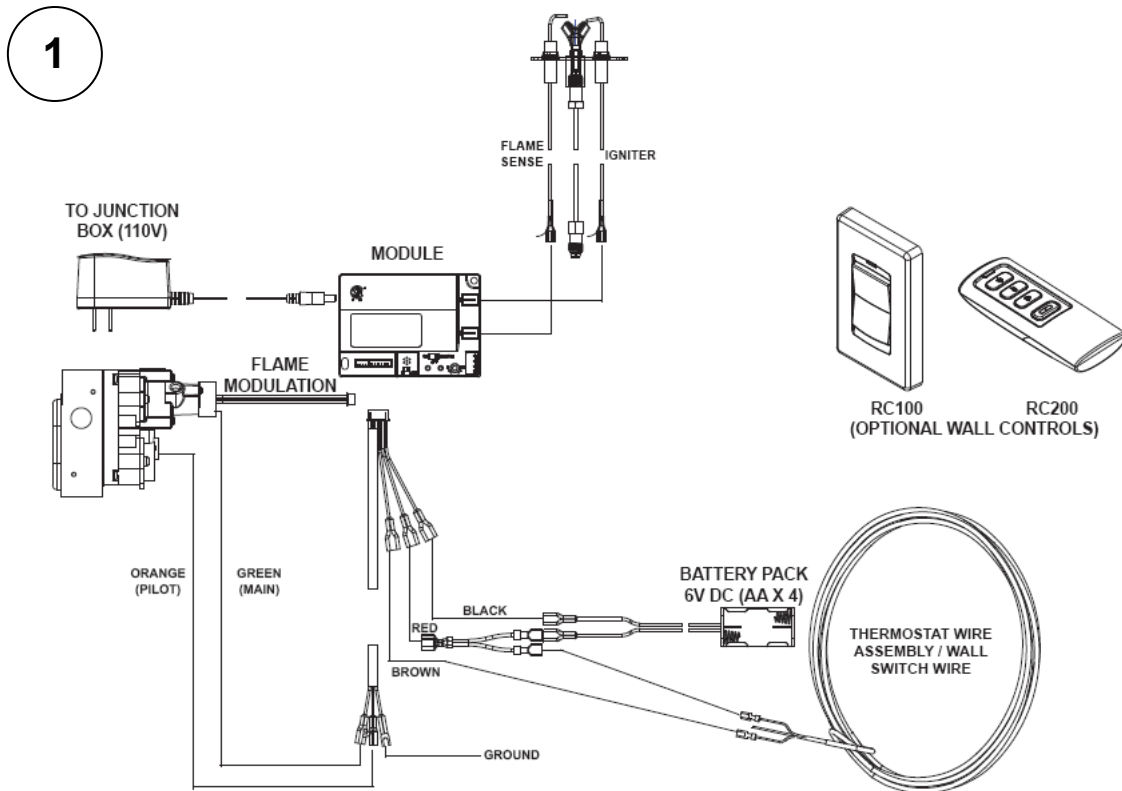

Must be in the ON or REMOTE setting for unit to operate. Remote must be unlearned from system to isolate from system and troubleshoot.

To unlearn the remote, press the learn button and wait 10 seconds.

* Troubleshooting assumes the wireless controls & battery backup have been eliminated from the system. To do this the remote must be “unlearned” from the system.

Problem: Pilot wont' light, no noise and no spark *

- 3. No power to junction box x
- 4. No power from junction bo
- 5. No power from 6Volt DC transformer

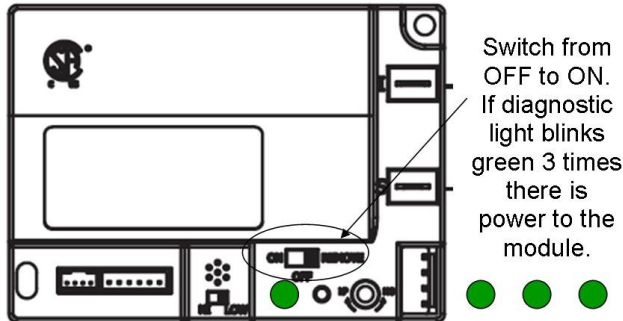

If the module does not flash, trace power supply to junction box, from junction box and from 6 Volt transformer.

Pulling and re-connecting the power supply cord from transformer does not serve as the same test as turning switch from OFF to ON.

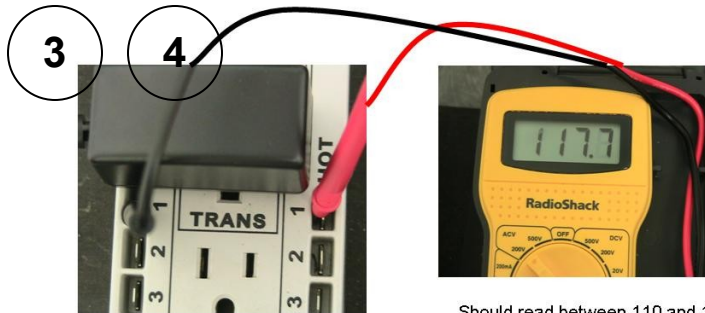

If this is no power from junction box, trace electrical supply to junction box including proper wiring at junction box.

Testing 120 VAC to and from junction box.

Should read between 110 and 120 volts ac.

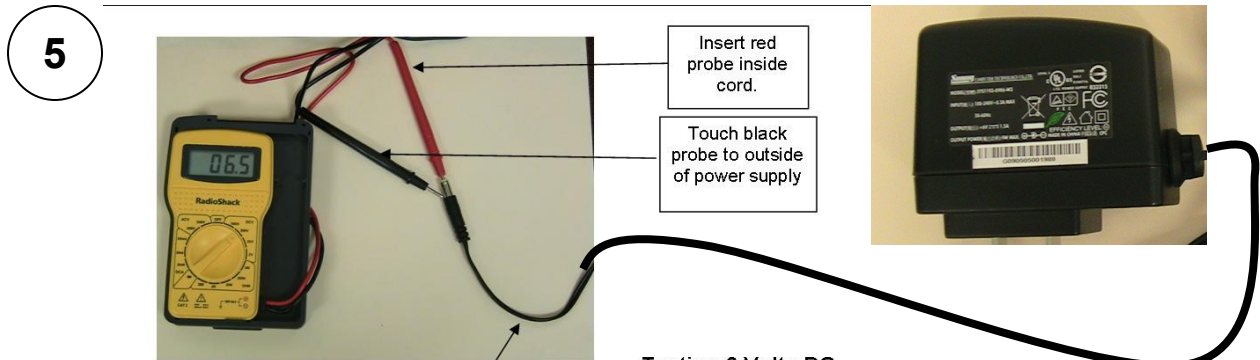

With transformer plugged into junction box, pull transformer power supply cord from module.

Testing 6 Volts DC from transformer

* Troubleshooting assumes the wireless controls & battery backup have been eliminated from the system. To do this the remote must be "unlearned" from the system.

Problem: Pilot wont' light, no noise and no spark *

6. Wired wall switch not wired properly.

6

The wiring to the wall switch may not be correct if fireplace does not turn on when the switch on the module is in the REMOTE position.

AND/OR...the optional wired wall switch is in the ON position.

Red and Brown wire connect to wall switch.

Diagram to the bottom/ right reviews proper switch operation when wired wall switch and wireless controls are both installed.

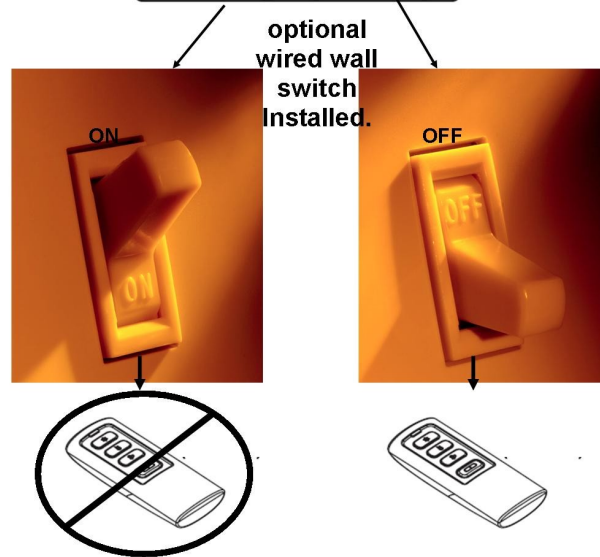
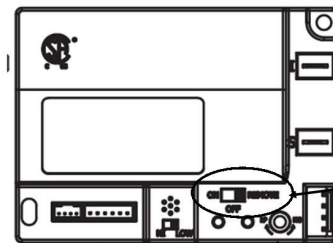
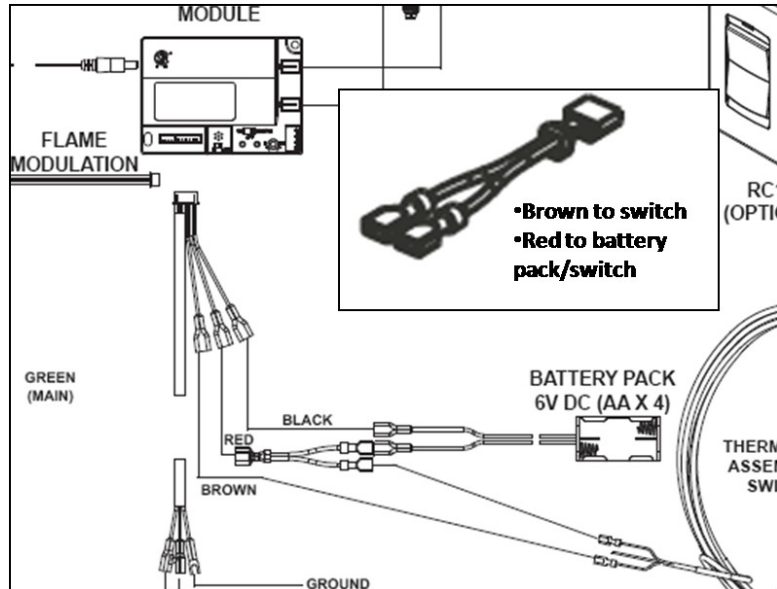

* Troubleshooting assumes the wireless controls & battery backup have been eliminated from the system. To do this the remote must be "unlearned" from the system.

Problem: Pilot wont' light, no noise and no spark *

- 7. LP/NG switch on module damaged or not fully engaged into LP or NG setting.
- 8. Faulty Module

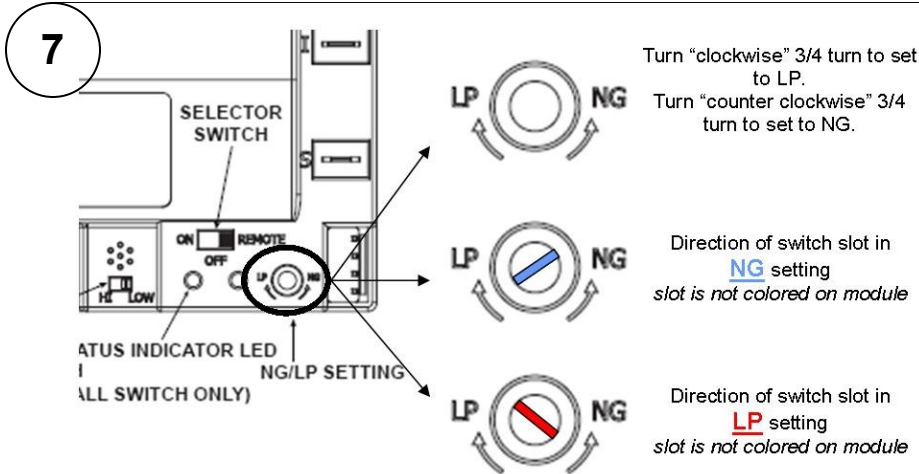

If the NG/LP selector switch is not turned completely to NG or LP setting, the fireplace will not ignite and will go into lockout mode.

If the selector switch spins freely and does not engage into NG or LP position the switch is damaged and the module go into lockout mode. Damaged switch requires module replacement.

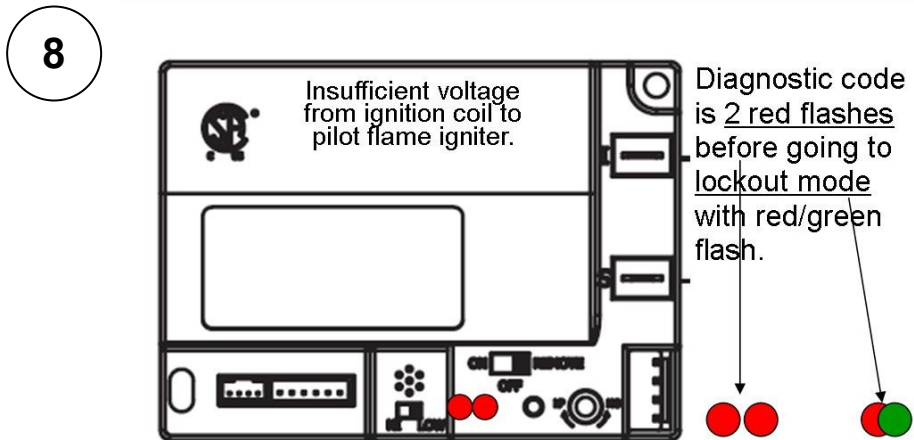

* Troubleshooting assumes the wireless controls & battery backup have been eliminated from the system. To do this the remote must be "unlearned" from the system.

Problem: The module makes sparking noise, but no spark * **

The problem may be:

Go to page 29 to familiarize yourself with module diagnostic codes.

1. Loose or improper wiring
2. System is not grounded
3. Igniter wire is loose or disconnected
4. Improper gap between igniter and pilot hood

**** Notice ****

- Disconnect power to the system prior to disconnecting any components by switching the ON/OFF/REMOTE module switch to the OFF position. Interrupting power to stepper motor can freeze motor position (see page 29).
- It is not recommended to operate the ignition control module with disconnected wire connections. A short could cause permanent damage.
- Introducing the pilot sensor rod with a false flame, such as from a flame stick, will cause the module to go into lock-out mode. This is due to a

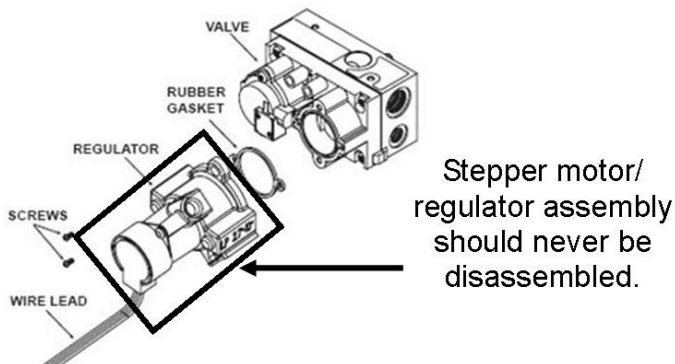
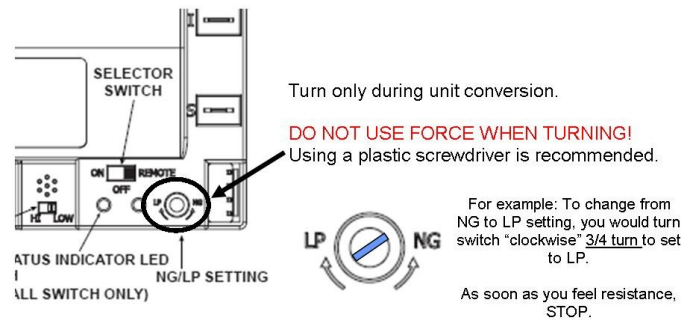
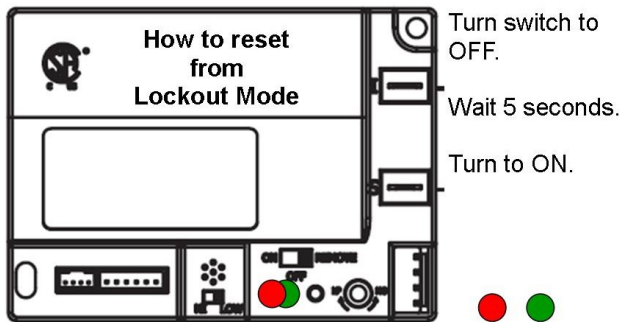

* Troubleshooting assumes the wireless controls & battery backup have been eliminated from the system. To do this the remote must be "unlearned" from the system.

** IntelliFire Plus IPI ignition module emits beeps during operation. The noise referred to in this section is noise from the module ignition coil which creates voltage for pilot igniter.

Problem: The module makes noise, but no spark

1. Loose or improper wiring
2. Pilot assembly is not grounded

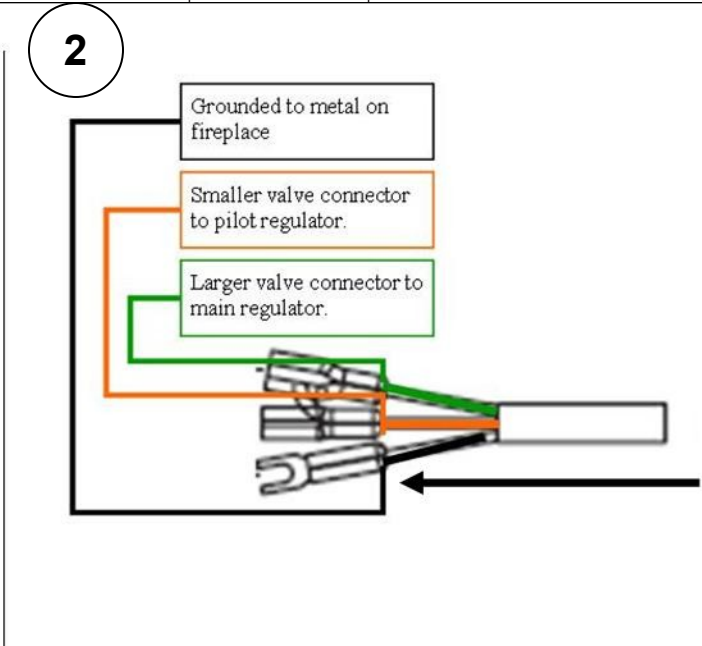
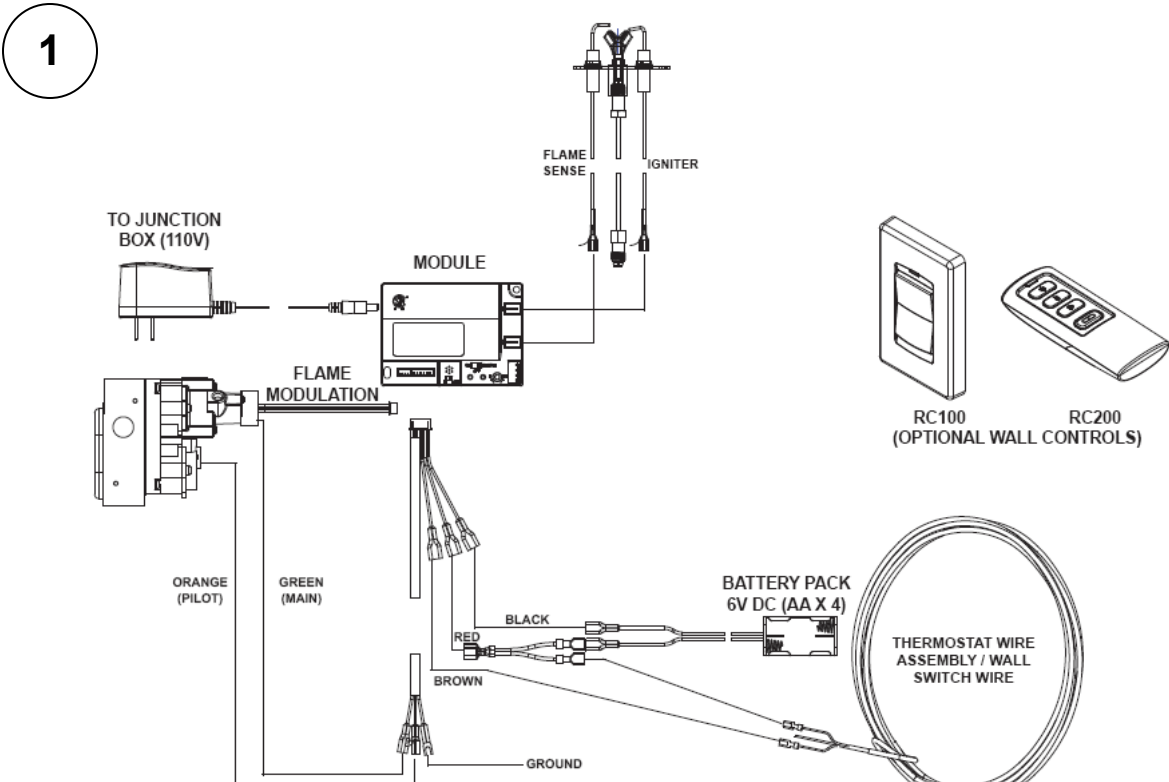

The black wire, grouped with the orange and green wire is the ground wire. Make sure it tightly secured to metal chassis of fireplace.

* Troubleshooting assumes the wireless controls & battery backup have been eliminated from the system. To do this the remote must be “unlearned” from the system.

Problem: The module makes noise, but no spark

- 3. Igniter is disconnected, loose or shorted to fireplace.
- 4. Improper gap between igniter and pilot hood

3

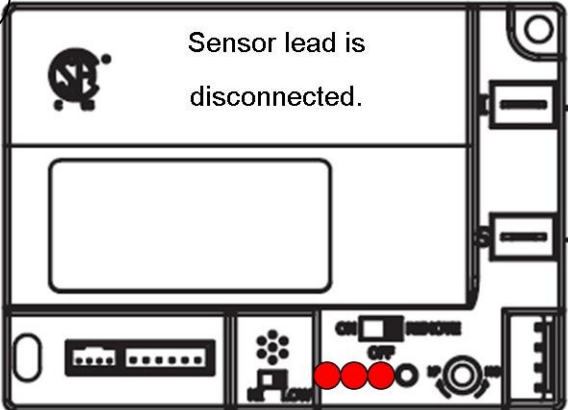

Sensor lead is disconnected.

Diagnostic code is 3 red flashes before going to lockout mode with red/green flash.

If igniter is shorted it will attempted to light for 60 seconds before module times out.

It will flash green 3 times and go into lockout.

Voltage shorted to ground may cause damage to module, resulting in damaged module.

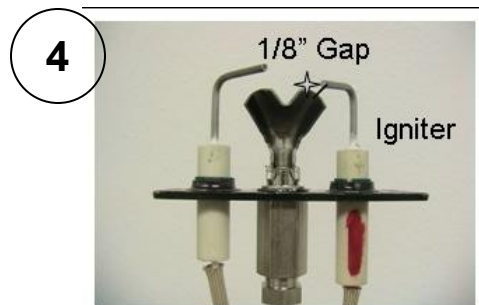

* Troubleshooting assumes the wireless controls & battery backup have been eliminated from the system. To do this the remote must be “unlearned” from the system.

Problem: Pilot sparks, but pilot will not light.

The problem may be:

1. Gas supply
2. Faulty module voltage to valve
3. Faulty valve

Go to page 29 to familiarize yourself with module diagnostic codes.

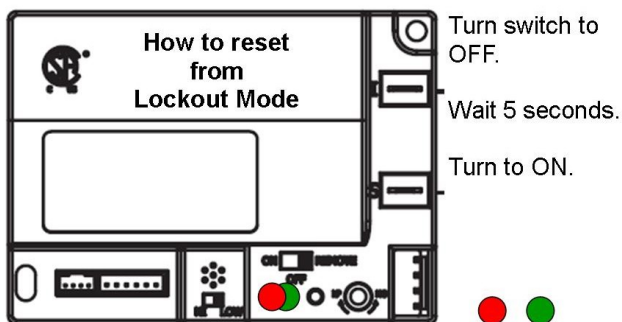

**** Notice ****

- Disconnect power to the system prior to disconnecting any components by switching the ON/OFF/REMOTE module switch to the OFF position. Interrupting power to stepper motor can freeze motor position (see page 29).
- It is not recommended to operate the ignition control module with disconnected wire connections. A short could cause permanent damage.
- Introducing the pilot sensor rod with a false flame, such as from a flame stick, will cause the module to go into lock-out mode. This is due to a

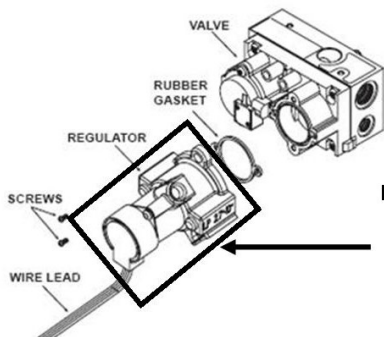

Stepper motor/regulator assembly should never be disassembled.

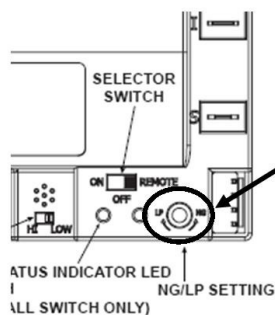

Turn only during unit conversion.

DO NOT USE FORCE WHEN TURNING!
Using a plastic screwdriver is recommended.



For example: To change from NG to LP setting, you would turn switch "clockwise" 3/4 turn to set to LP.

As soon as you feel resistance, STOP.

* Troubleshooting assumes the wireless controls & battery backup have been eliminated from the system. To do this the remote must be "unlearned" from the system.

Problem: Pilot sparks, but pilot will not light.

1. Gas supply

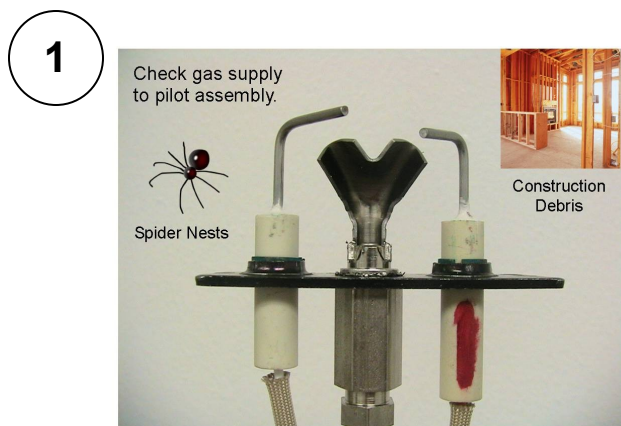
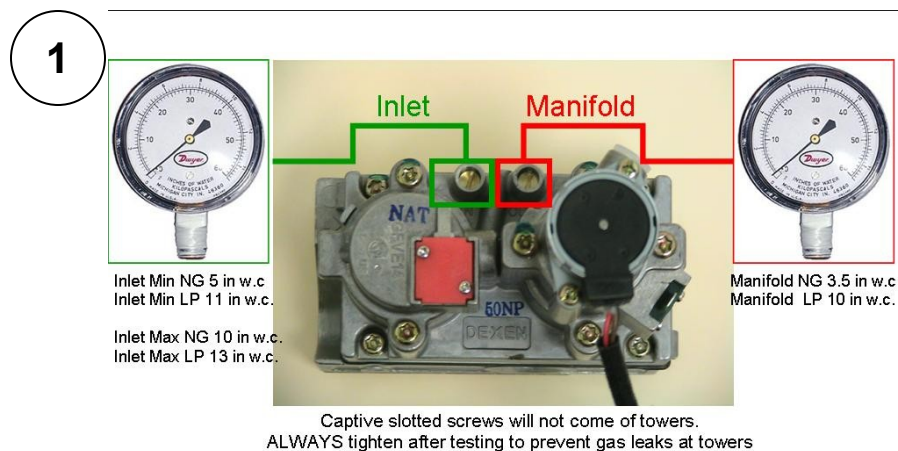
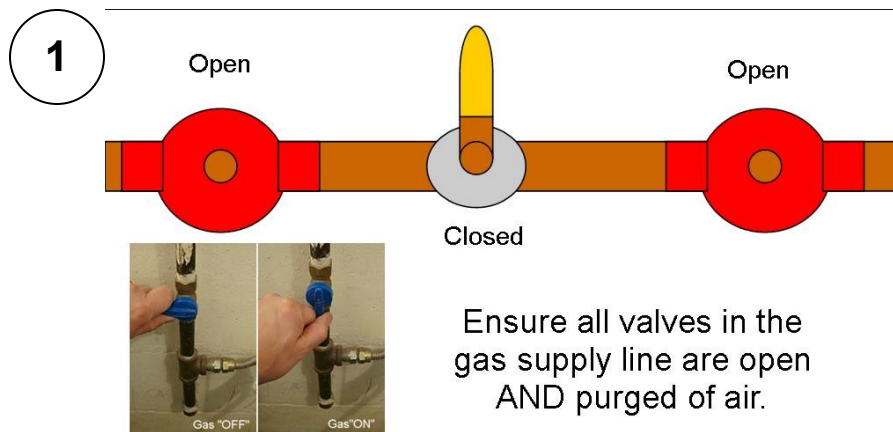

* Troubleshooting assumes the wireless controls & battery backup have been eliminated from the system. To do this the remote must be "unlearned" from the system.

Problem: Pilot sparks, but pilot will not light.

2. Faulty module voltage to valve
3. Faulty valve (pilot solenoid)

2

Voltage to Pilot Solenoid
(test during lighting sequence)

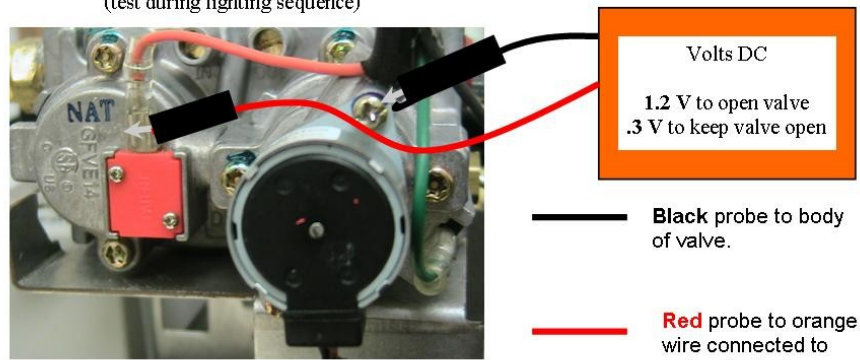

Volts DC

1.2 V to open valve
.3 V to keep valve open

— Black probe to body of valve.

— Red probe to orange wire connected to valve. (pull wire slightly away from connector to touch connector)

3

Valve Ohms Test

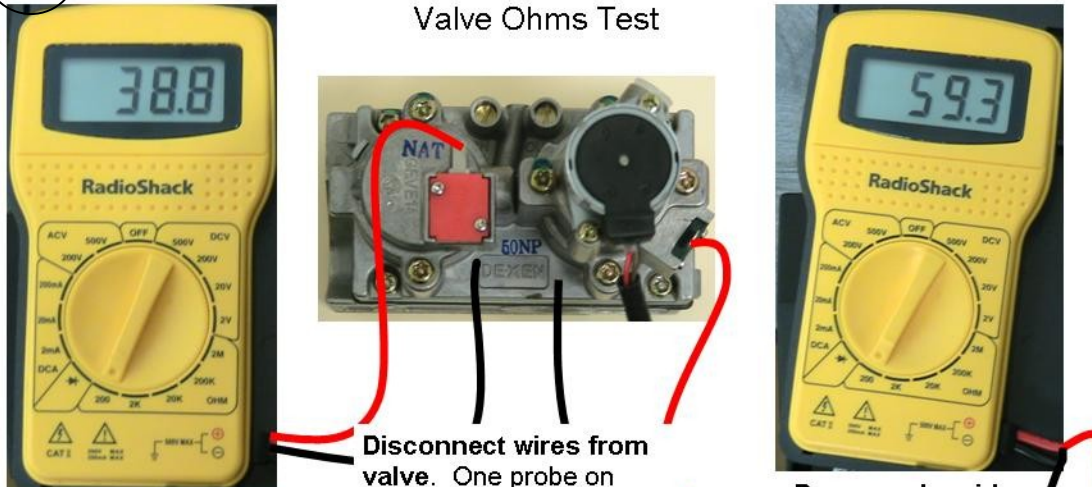

Pilot solenoid
should read between
37 to 47.

Disconnect wires from
valve. One probe on
body of valve & one
probe on pilot OR burner
wire solenoid connection.

Burner solenoid
should read between
55 to 65.

* Troubleshooting assumes the wireless controls & battery backup have been eliminated from the system. To do this the remote must be “unlearned” from the system.

Problem: Pilot lights, but continues to spark and main burner will not ignite.

The problem may be:

1. Gas Supply
2. Sensor rod shorted or disconnected.
3. Poor flame rectification or contaminated sensor
4. Faulty valve

Go to page 29 to familiarize yourself with module diagnostic codes.

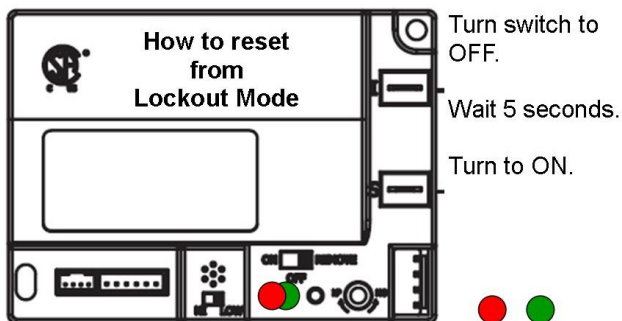

**** Notice ****

- Disconnect power to the system prior to disconnecting any components by switching the ON/OFF/REMOTE module switch to the OFF position. Interrupting power to stepper motor can freeze motor position (see page 29).
- It is not recommended to operate the ignition control module with disconnected wire connections. A short could cause permanent damage.
- Introducing the pilot sensor rod with a false flame, such as from a flame stick, will cause the module to go into lock-out mode. This is due to a

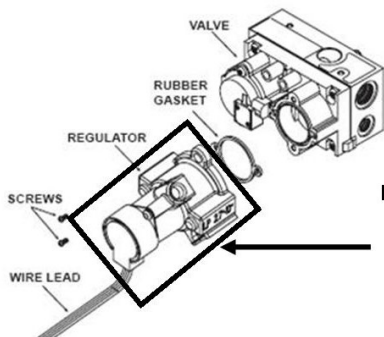

Stepper motor/regulator assembly should never be disassembled.

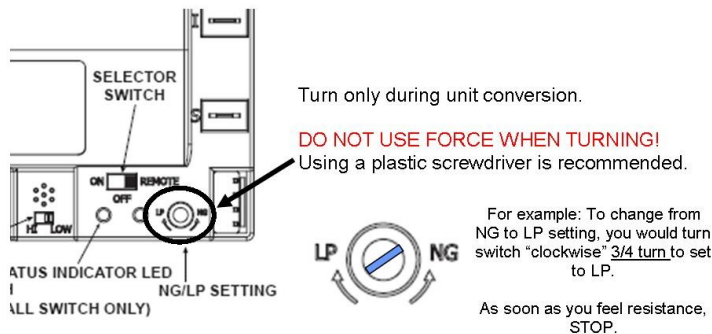

* Troubleshooting assumes the wireless controls & battery backup have been eliminated from the system. To do this the remote must be "unlearned" from the system.

Problem: Pilot lights, but continues to spark and main burner will not ignite.

1. Gas supply
2. Sensor rod shorted or disconnected.

1

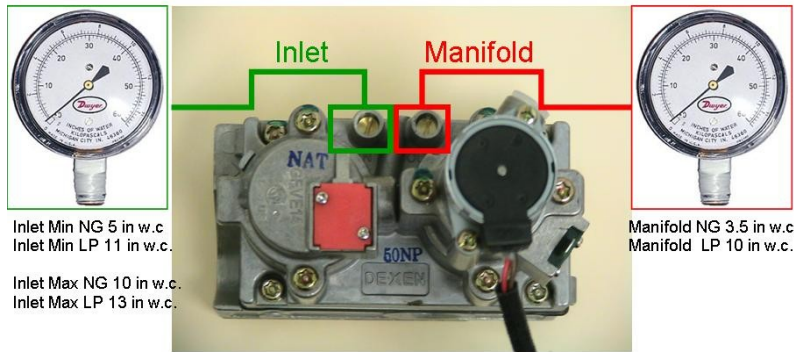

Inlet Min NG 5 in w.c.
Inlet Min LP 11 in w.c.

Inlet Max NG 10 in w.c.
Inlet Max LP 13 in w.c.

Manifold NG 3.5 in w.c.
Manifold LP 10 in w.c.

Captive slotted screws will not come off towers.
ALWAYS tighten after testing to prevent gas leaks at towers

2

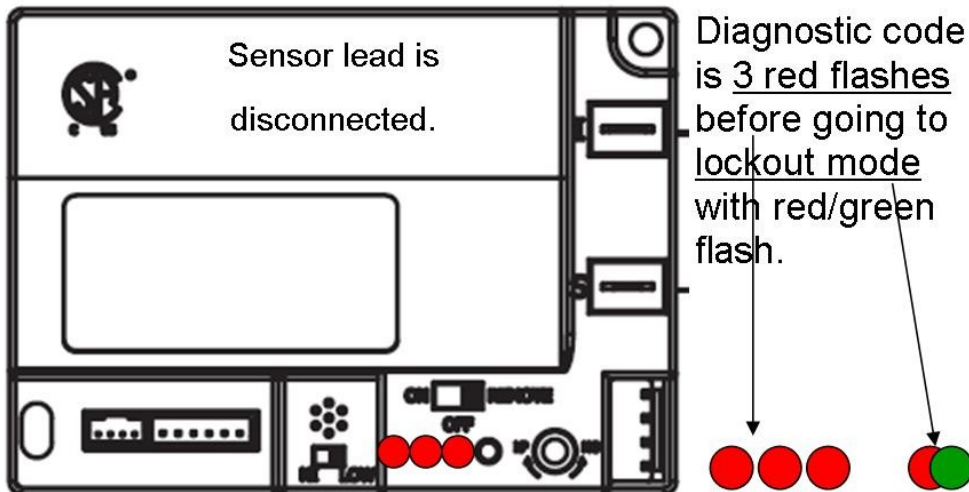

* Troubleshooting assumes the wireless controls & battery backup have been eliminated from the system. To do this the remote must be “unlearned” from the system.

Problem: Pilot lights, but continues to spark and main burner will not ignite.

- 3. Poor flame rectification or contaminated sensor
- 4. Faulty Valve (Burner Solenoid)

3

If contaminated sensor wire prevents continuity the system will time out after 60 seconds and go into lockout mode. Visible carbon will be on sensor rod and will need to be cleaned with emery cloth.

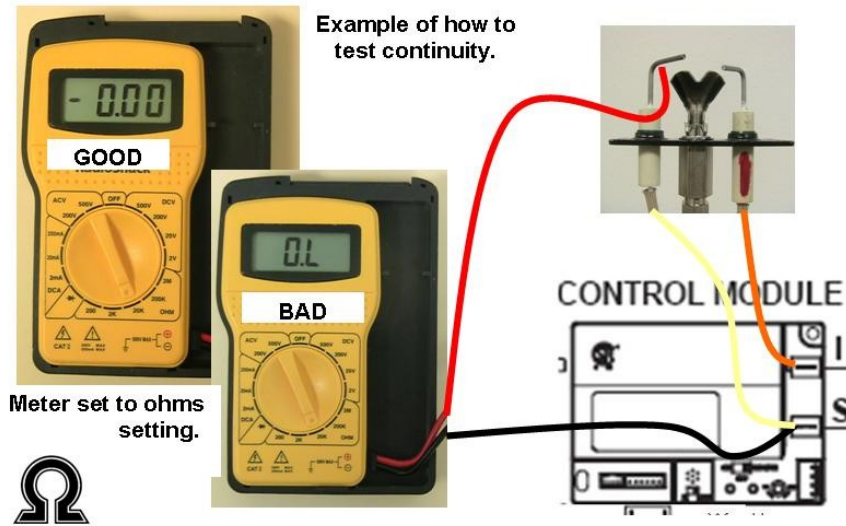

4

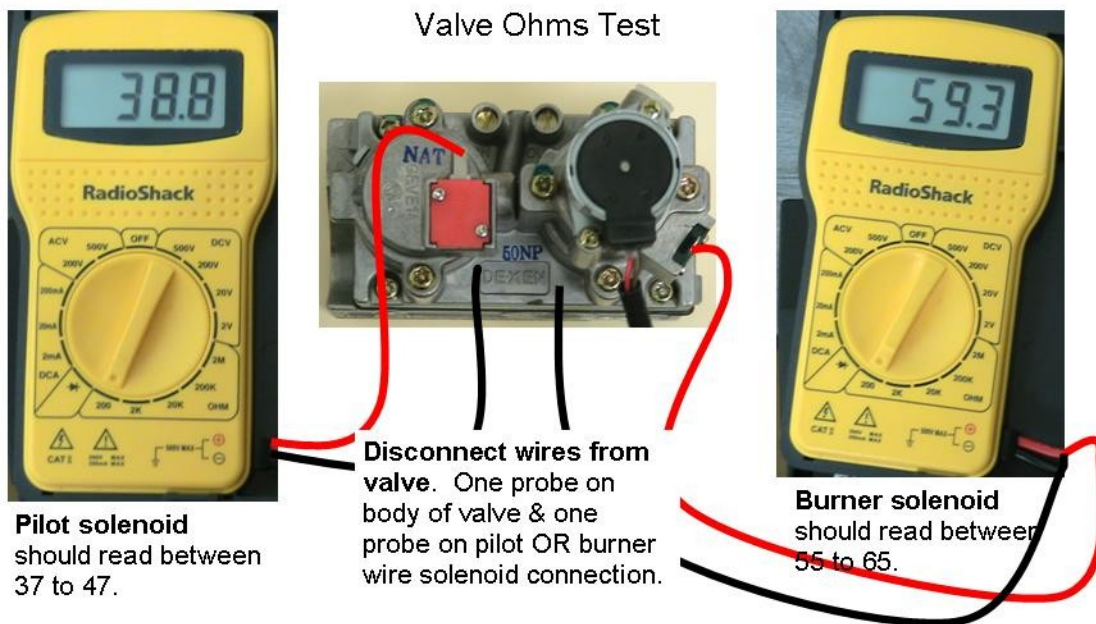

* Troubleshooting assumes the wireless controls & battery backup have been eliminated from the system. To do this the remote must be “unlearned” from the system.

Problem: Pilot lights, stops sparking, and pilot remains lit. Burner will not light.

The problem may be:

1. Faulty module
2. Faulty valve

Go to page 29 to familiarize yourself with module diagnostic codes.

**** Notice ****

- Disconnect power to the system prior to disconnecting any components by switching the ON/OFF/REMOTE module switch to the OFF position. Interrupting power to stepper motor can freeze motor position (see page 29).
- It is not recommended to operate the ignition control module with disconnected wire connections. A short could cause permanent damage.
- Introducing the pilot sensor rod with a false flame, such as from a flame stick, will cause the module to go into lock-out mode. This is due to a

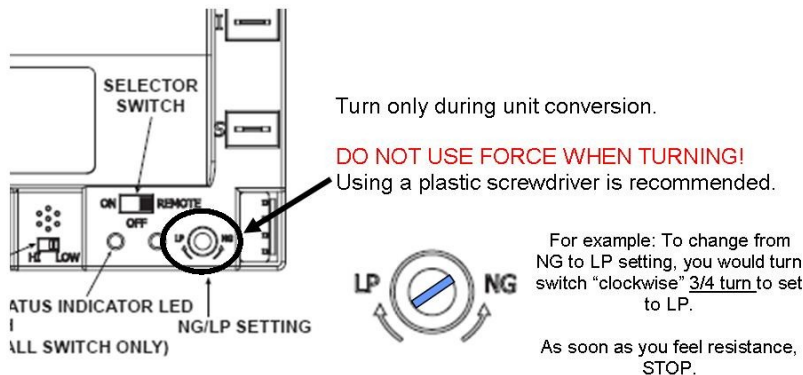
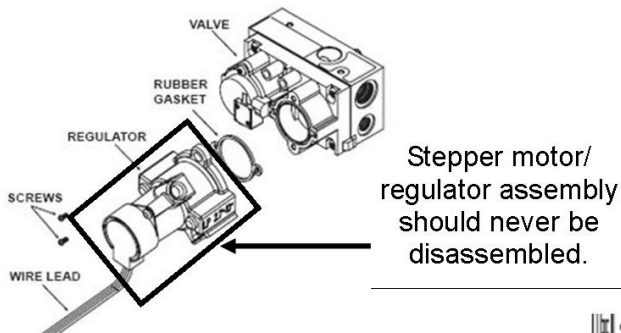
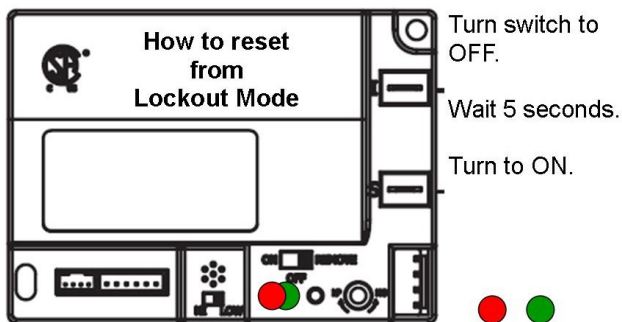

* Troubleshooting assumes the wireless controls & battery backup have been eliminated from the system. To do this the remote must be "unlearned" from the system.

Problem: Pilot lights, stops sparking, and pilot remains lit. Burner will not light.

1. Faulty module (burner solenoid)
2. Faulty valve (burner solenoid)

1

Voltage to Main Valve Solenoid
(test during lighting sequence)

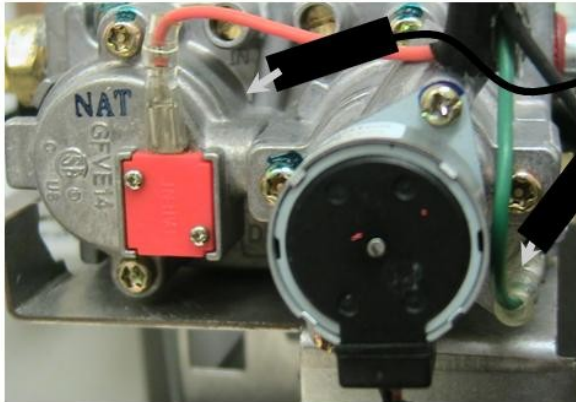

Volts DC
1.6 V to open valve
.3 V to keep valve open

- Black probe to body of valve.
- Red probe to green wire connected to valve. (pull wire slightly away from connector to touch connector)

2

Valve Ohms Test

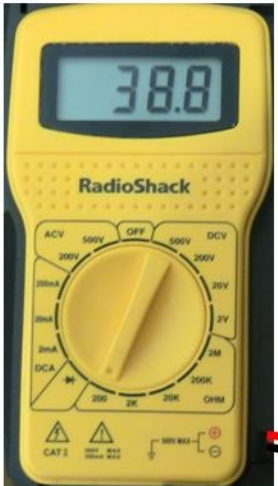

Pilot solenoid should read between 37 to 47.



Disconnect wires from valve. One probe on body of valve & one probe on pilot OR burner wire solenoid connection.

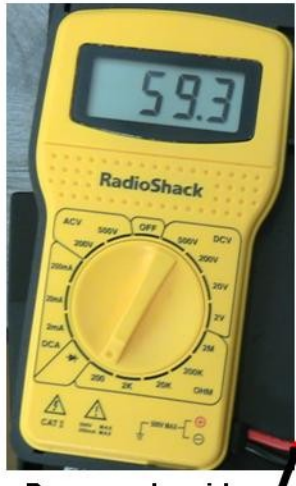

Burner solenoid should read between 55 to 65.

* Troubleshooting assumes the wireless controls & battery backup have been eliminated from the system. To do this the remote must be "unlearned" from the system.

Problem: Low pressure reading on manifold side when set to high flame position.

1. Stepper motor lost power during operation and must be reset.
2. Gas Supply
3. Module is programmed to remote, but using module HI/LOW switch. Using module high/low setting does not change.

1 If the power is interrupted to the stepper motor as it resets to the high position the programming accepts the last position as the high setting, which is the programmed action during shut down. If it can't position to high due to power interruptions the stepper motor needs to be reset.

Manual Reset

1. Turn ON/OFF/REMOTE slider switch on module to the OFF position.
2. Return to REMOTE position.
3. Check manifold pressure.
4. Repeat step #2 if still low.

RC300 Method

1. Remove stepper motor wiring harness from control module.
2. RC300 flame adjust screen—adjust to MINIMUM and press SELECT.
3. Reconnect stepper motor wire to control module.
4. Check manifold pressure.
5. Repeat steps #2 & #3 if still low.

**** Notice ****

- Disconnect power to the system prior to disconnecting any components by switching the ON/OFF/REMOTE module switch to the OFF position. Interrupting power to stepper motor can freeze motor position (see page 29).
- It is not recommended to operate the ignition control module with disconnected wire connections. A short could cause permanent damage.
- Introducing the pilot sensor rod with a false flame, such as from a flame stick, will cause the module to go into lock-out mode. This is due to a

2

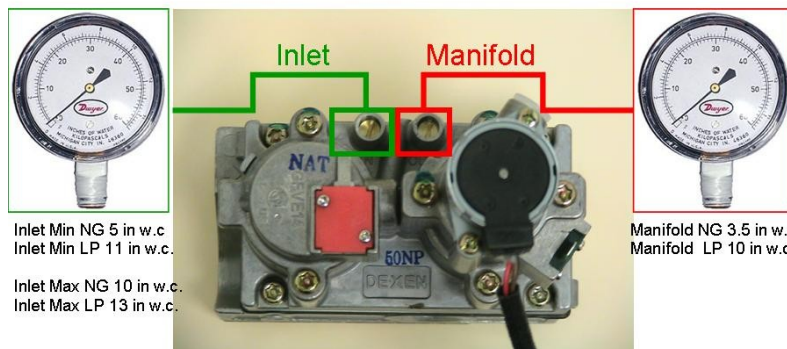

Inlet Min NG 5 in w.c.
Inlet Min LP 11 in w.c.

Inlet Max NG 10 in w.c.
Inlet Max LP 13 in w.c.

Manifold NG 3.5 in w.c
Manifold LP 10 in w.c.

Captive slotted screws will not come off towers.
ALWAYS tighten after testing to prevent gas leaks at towers

* Troubleshooting assumes the wireless controls & battery backup have been eliminated from the system. To do this the remote must be “unlearned” from the system.

Problem: Low pressure reading on manifold side when set to high flame position.

3. Module is programmed to remote and using module HI/LOW switch.



Remote control has been programmed to module, which overrides the HI/LOW switch on the module. **MUST CLEAR THE MODULE FROM THE REMOTE** if remote is not to be used.

1. Press the learn button on the module.
(consistent blink)
2. Press the learn button a second time
(blinking stops)
3. Module is cleared.

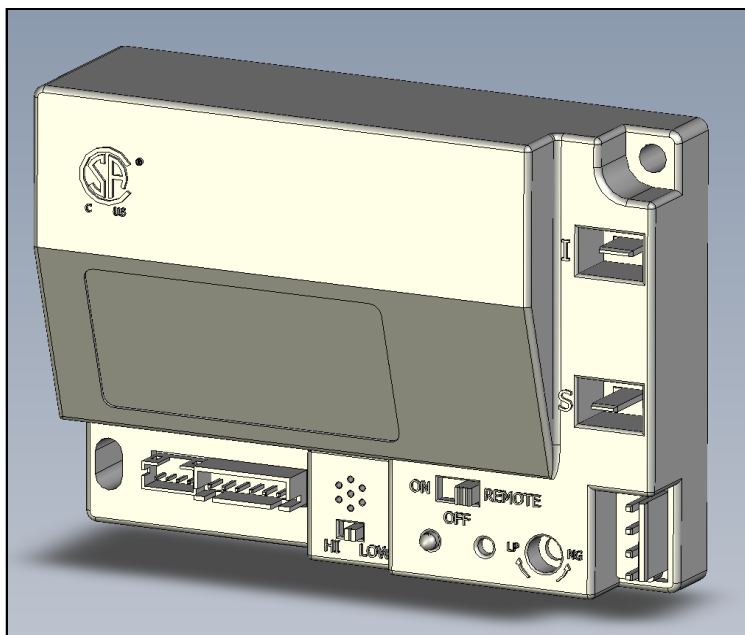

* Troubleshooting assumes the wireless controls & battery backup have been eliminated from the system. To do this the remote must be “unlearned” from the system.

Diagnostic Codes are listed below and should be used as an additional tool to help diagnose failure modes. Use the troubleshooting guide to check all possible failures before changing any component parts.

CODE	RESPONSE	ERROR CAUSE	ERROR RESOLUTION
1 Flash	Module flashes error code and goes into lockout mode.	1. Fuel-type selector in incorrect position 2. Fuel-type selector switch damaged	1. Verify that the selector stops at the correct position when rotated gently with a precision screwdriver
2 Flash	Module flashes error code and goes into lockout mode.	Insufficient voltage from ignition coil to pilot flame igniter	Clear Lock-Out and attempt ignition. If condition persists, replace module
3 Flash	Pilot sparks and may ignite for up to 60 secs, but main will not open. If condition occurs for \geq 60 sec, module flashes error code, shuts down pilot, and goes into lockout mode	1. Inadequate gas supply 2. False flame detected 3. Short in sense lead 4. Sense and/or igniter lead disconnected	1. Verify proper inlet pressure to the gas line 2. Verify that pilot leads are correctly terminated to the control module, and that no shorted wires exist. 4. Verify that the pilot sense rod, igniter rod, and hood are clean.

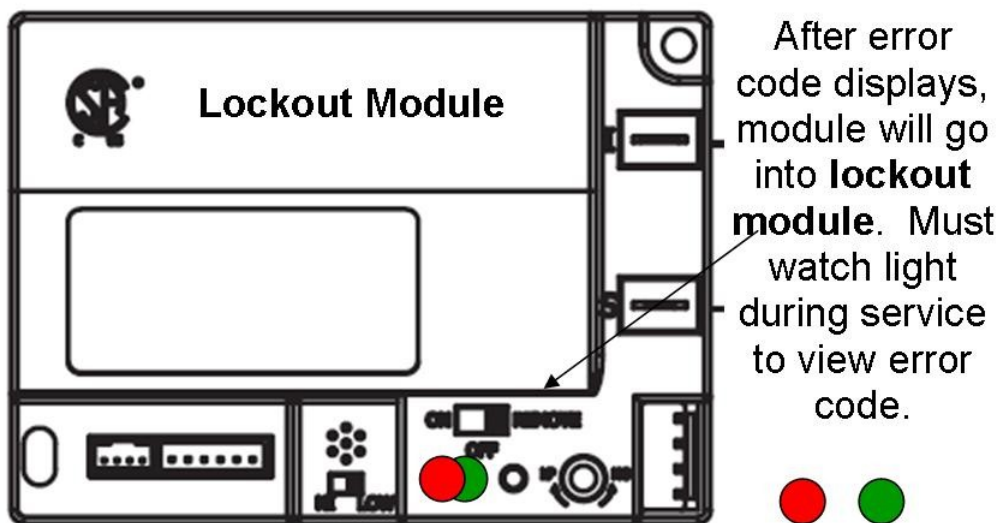

Visual Inspection

Area/System	Proper Readings/Reference Info/Items to be checked:	
Visual Inspection <i>Refer to appropriate installation and operation manual for all areas</i>		
1. Proper Installation/Condition		
a. Vent System	Does the installation meet venting requirements for... rise to run ratio? vent cap type? vent cap location? venting size?	
b. Gas Supply Components	Gas line sizing and components must meet ANSI Z223.1 and local codes requirements. Supply pipe must be ½" minimum. Note all appliances supplied inline with fireplace. Locate all shut off valves. What position are they in?	
c. Proper Clearances	Does the installation maintain proper clearances to... walls & ceiling? combustible mantels & surrounds? household goods and furniture?	
e. Glass Assembly	Is the glass... clean? free of soot? properly retained with all appropriate fasteners? gasket pliable and free of damage?	
f. Logs	Are the logs... appropriately placed? free of soot?	
g. Firebox		
h. Wiring/Ignition Components	Do the wiring connections and/or components show signs of... heat damage? loose or damaged wiring connections?	
i. Burner	Is the burner... set up with properly placed embers? free of corrosion? properly seated to the burner orifice? aligned with pilot igniter over burner ports?	

Electrical System

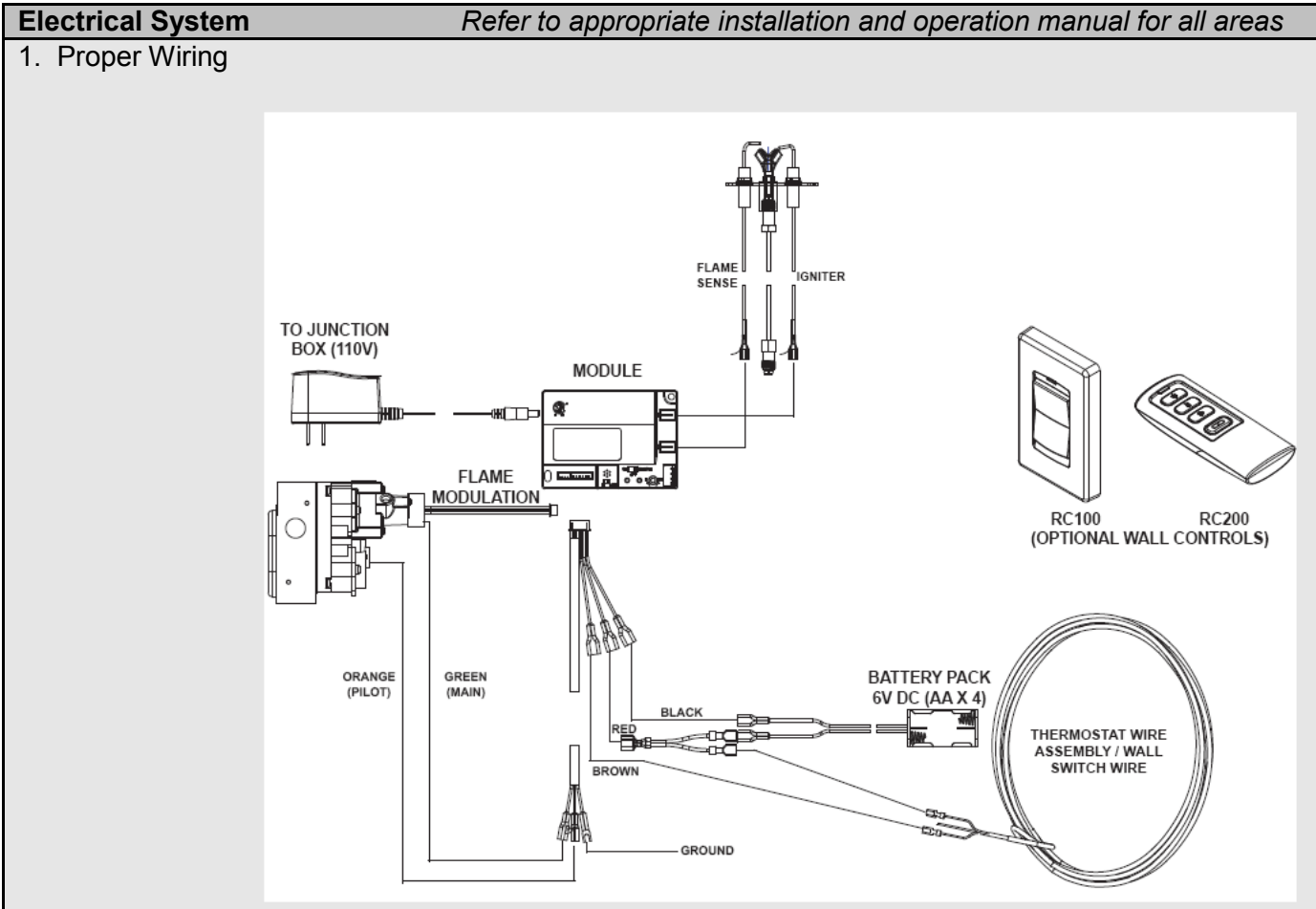

a. Control Module ON/OFF/REMOTE Setting

“OFF” – Module is dead.
 “ON” – Used during set up or testing without learned remote
 “REMOTE” – Allows wireless controls & optional wired wall switch to operate.

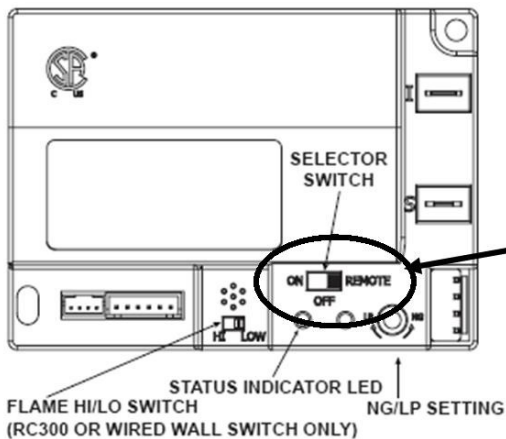

Must be in the ON or REMOTE setting for unit to operate. Remote must be unlearned from system to isolate from system and troubleshoot.

To unlearn the remote, press the learn button and wait 10 seconds.

Electrical System continued...

<p>b. Optional Wired Wall Switch</p>	<p>Overrides remote. Must be in OFF position for remote to work.</p>
--------------------------------------	--

<p>c. Proper Gap between pilot hood and igniter</p>	
---	--

3. System Ground

	<p>The black wire, grouped with the orange and green wire is the ground wire. Make sure it tightly secured to metal chassis of fireplace.</p>
--	---

Electrical System continued...

4. Voltage

a. 120 VAC to and from Junction Box

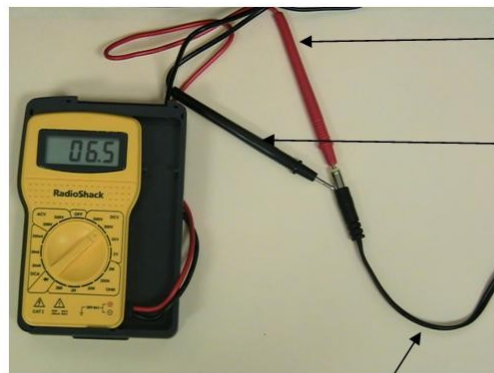
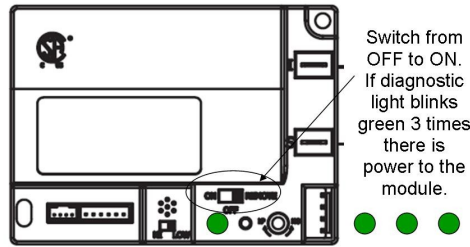

Insert red probe inside cord.

Touch black probe to outside of power supply

With transformer plugged into junction box, pull transformer power supply cord from module.

Testing 6 Volts DC from transformer

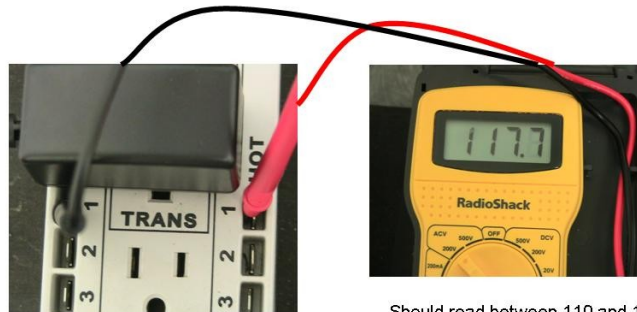

Testing 120 VAC to and from junction box.

Should read between 110 and 120 volts ac.

Electrical System continued...

c. To valve pilot solenoid

Voltage to Pilot Solenoid
(test during lighting sequence)

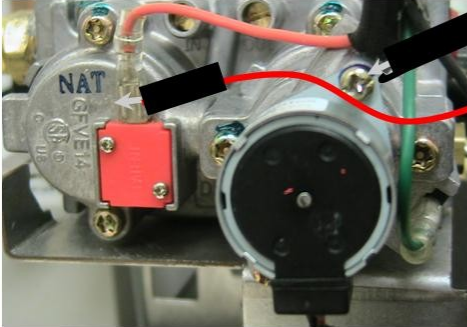

Volts DC

1.2 V to open valve
.3 V to keep valve open

— **Black** probe to body of valve.

— **Red** probe to orange wire connected to valve. (pull wire slightly away from connector to touch connector)

d. To valve burner solenoid

Voltage to Main Valve Solenoid
(test during lighting sequence)

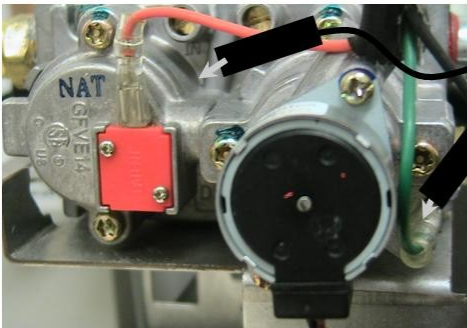

Volts DC

1.6 V to open valve
.3 V to keep valve open

— **Black** probe to body of valve.

— **Red** probe to green wire connected to valve. (pull wire slightly away from connector to touch connector)

Electrical System continued...

5. Continuity

a. Wiring Harness

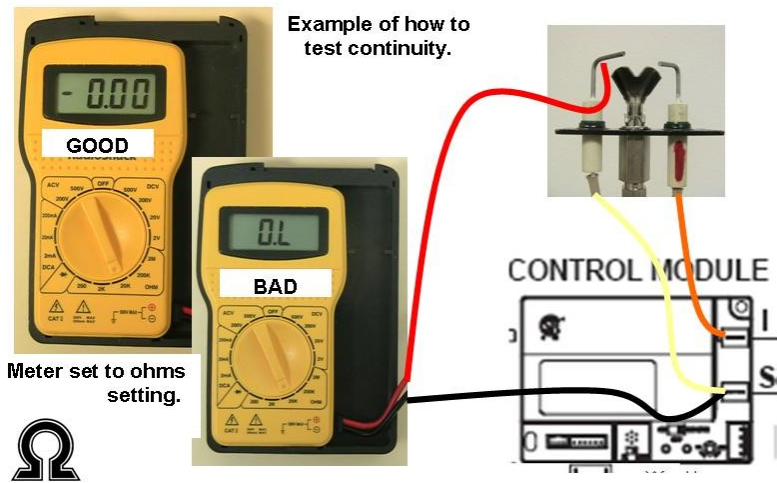

Gas System

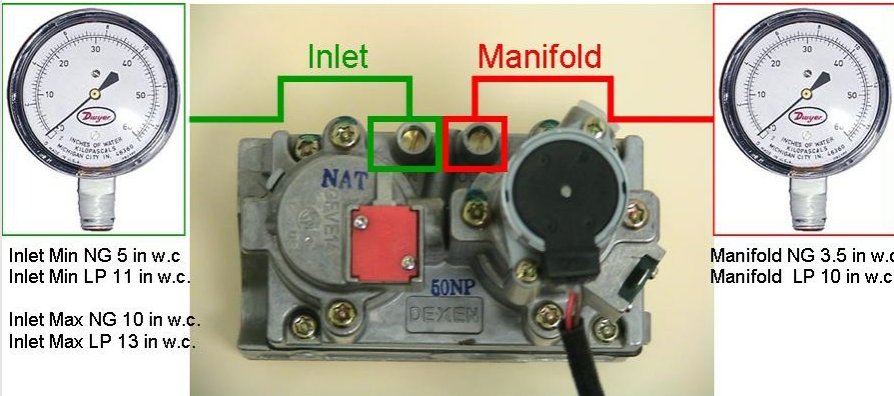
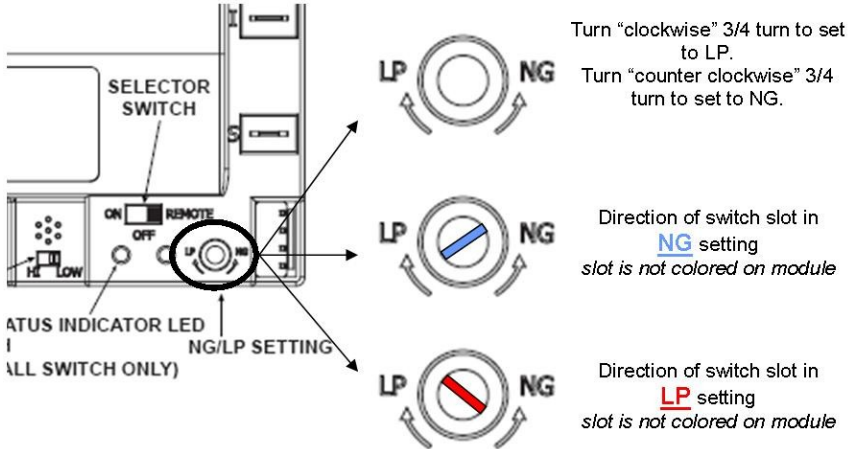
Area/System	Proper Readings/Reference Info/Items to be checked:	
Gas Supply <i>Refer to appropriate installation and operation manual for all areas</i>		
1. Inlet Pressure 2. Manifold Pressure	 <p data-bbox="553 699 747 808"> Inlet Min NG 5 in w.c. Inlet Min LP 11 in w.c. Inlet Max NG 10 in w.c. Inlet Max LP 13 in w.c. </p> <p data-bbox="1258 699 1451 741"> Manifold NG 3.5 in w.c. Manifold LP 10 in w.c. </p> <p data-bbox="732 856 1284 905"> Captive slotted screws will not come off towers. ALWAYS tighten after testing to prevent gas leaks at towers </p>	
3. Orifice Size		
a. Burner	Refer to conversion matrix or service parts list in owner & installation manual.	
b. Pilot	Marked on orifice.	
4. Air shutter setting	Refer to conversion matrix.	
5. Control Module Gas Type Switch	 <p data-bbox="581 1493 911 1556"> ATUS INDICATOR LED (ALL SWITCH ONLY) NG/LP SETTING </p> <p data-bbox="1149 1192 1425 1283"> Turn "clockwise" 3/4 turn to set to LP. Turn "counter clockwise" 3/4 turn to set to NG. </p> <p data-bbox="1154 1381 1414 1455"> Direction of switch slot in NG setting <i>slot is not colored on module</i> </p> <p data-bbox="1154 1535 1414 1608"> Direction of switch slot in LP setting <i>slot is not colored on module</i> </p>	

Gas System continued..

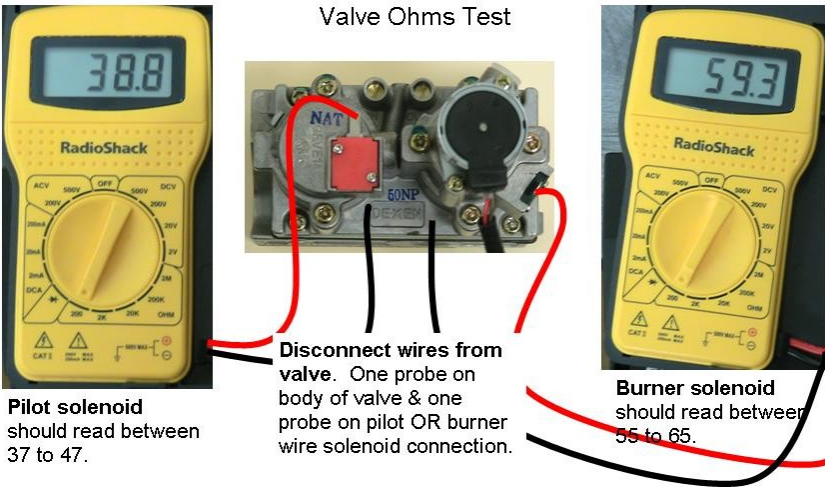
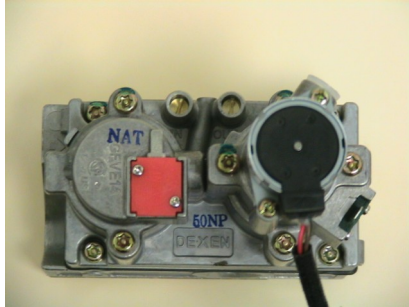
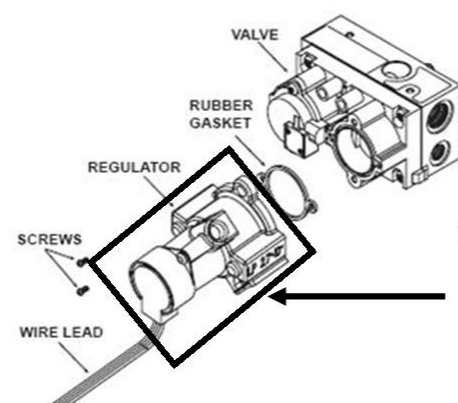
<p>6. Valve</p> <p>a. Ohms</p>	<p style="text-align: center;">Valve Ohms Test</p>  <p>Pilot solenoid should read between 37 to 47.</p> <p>Disconnect wires from valve. One probe on body of valve & one probe on pilot OR burner wire solenoid connection.</p> <p>Burner solenoid should read between 55 to 65.</p>	
<p>b. Proper regulator</p>	  <p>Stepper motor/ regulator assembly should never be disassembled.</p>	

