

4



SECTION FOUR

[4-1 BRASS D-PULL HANDLES](#)

[4-2 MILD STEEL D-PULL HANDLES](#)

[4-3 STAINLESS STEEL D-PULL HANDLES](#)

[4-4 STUD FIX D-PULL HANDLES](#)

[4-5 POLYAMIDE D-PULL HANDLES](#)

[4-6 POLYAMIDE D-PULL HANDLES](#)

BRASS

D-PULL HANDLE

FEATURES:

- Suitable for outdoor applications
- High quality chrome plating
- Available in various centre distances

DIMENSIONS:

Shaft Diameter = 8mm

MATERIAL & FINISH:

Material Brass

Finish Chrome plated

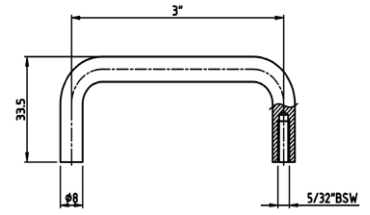

VERSION 1

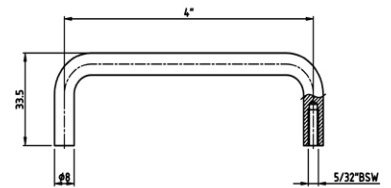

VERSION 2

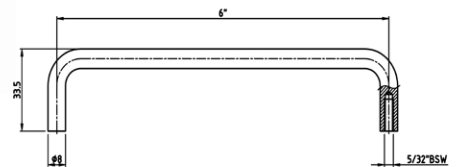

VERSION 3



VERSION	CENTRE DISTANCE	PART NUMBER
1	76mm	MT203-3
2	102mm	MT206-4
3	152mm	MT206-6

MILD STEEL D-PULL HANDLE

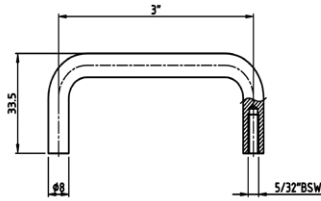

VERSION 1

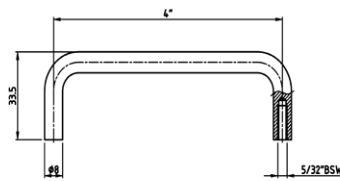

VERSION 2

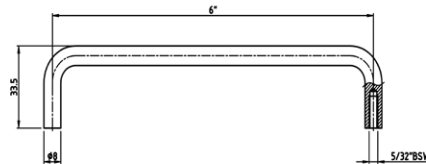

VERSION 3

FEATURES:

- Affordable alternative to brass
- High quality chrome plating
- Available in various centre distances

DIMENSIONS:

Shaft Diameter = 8mm

MATERIAL & FINISH:

Material Mild steel
Finish Chrome plated



VERSION	CENTRE DISTANCE	PART NUMBER
1	76mm	MT203-3M
2	102mm	MT206-4M
3	152mm	MT206-6M

STAINLESS STEEL D-PULL HANDLE

FEATURES:

- Suitable for outdoor applications
- Available in various centre distances

DIMENSIONS:

Shaft Diameter = 8mm

MATERIAL & FINISH:

Material Stainless steel (304 grade)

Finish Polished

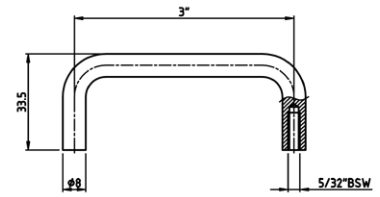

VERSION 1

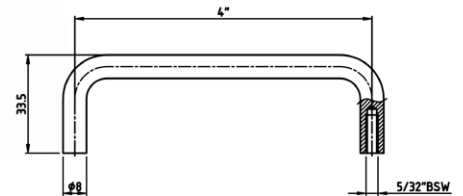

VERSION 2

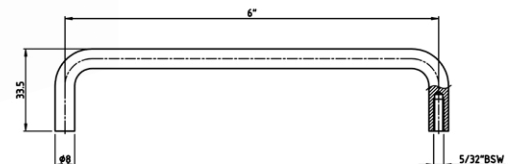

VERSION 3



VERSION	CENTRE DISTANCE	PART NUMBER
1	76mm	MT203-3S
2	102mm	MT206-4S
3	152mm	MT206-6S

STUD FIX D-PULL HANDLE

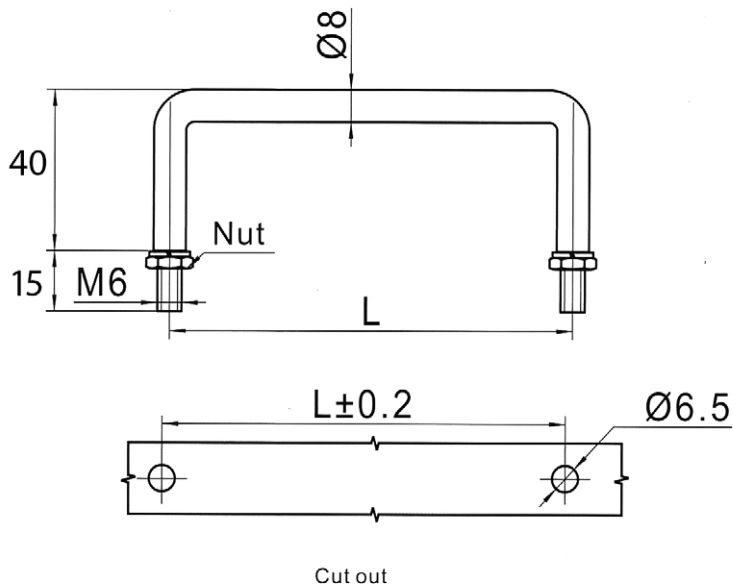

FEATURES:

- Stud fixing with M6 nut
- High quality chrome plating
- Available in various centre distances

DIMENSIONS:

Shaft Diameter = 8mm

MATERIAL & FINISH:

Material & Finish (refer to the table)

CENTRE DISTANCE	MATERIAL & FINISH	PART NUMBER
75mm	Mild steel, Chrome plated	LS507-75
100mm	Mild steel, Chrome plated	LS507-100
150mm	Mild steel, Chrome plated	LS507-150
75mm	304 Stainless steel, polished	LS507-S75
100mm	304 Stainless steel, polished	LS507-S100
150mm	304 Stainless steel, polished	LS507-S150



POLYAMIDE D-PULL HANDLE

FEATURES:

- Suitable for outdoor applications
- High quality material
- Mounting for M6 hex bolts

MATERIAL & FINISH:

Material Polyamide

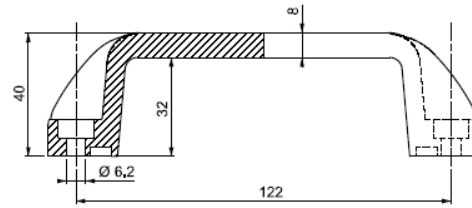
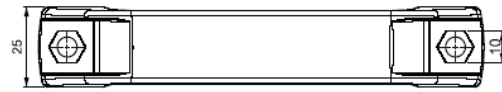

COLOUR

Black

PART NUMBER

M086-1

POLYAMIDE D-PULL HANDLE

FEATURES:

- Suitable for outdoor applications
- High quality material
- Mounting for M6 hex bolts

MATERIAL & FINISH:

Material Polyamide

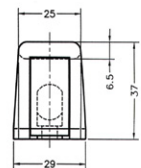
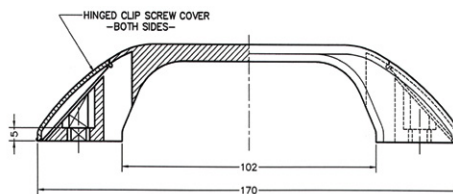
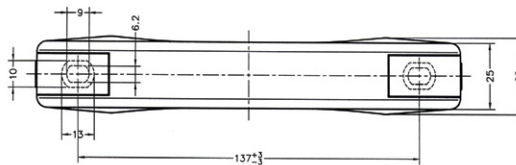

COLOUR

Black

PART NUMBER

DHPA20

HEAVY DUTY D-PULL HANDLE

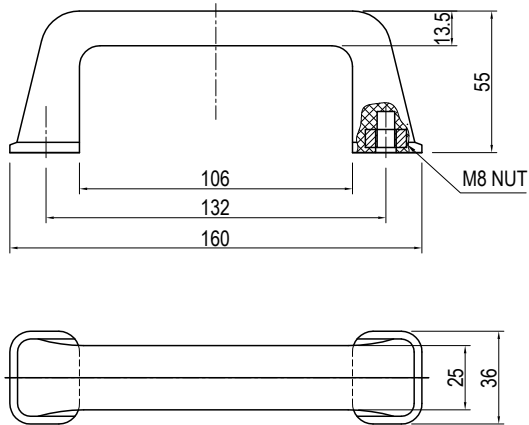

MATERIAL & FINISH:

- Black polypropylene



COLOUR	PART NUMBER
Black	LS505

POLYAMIDE D-PULL HANDLE

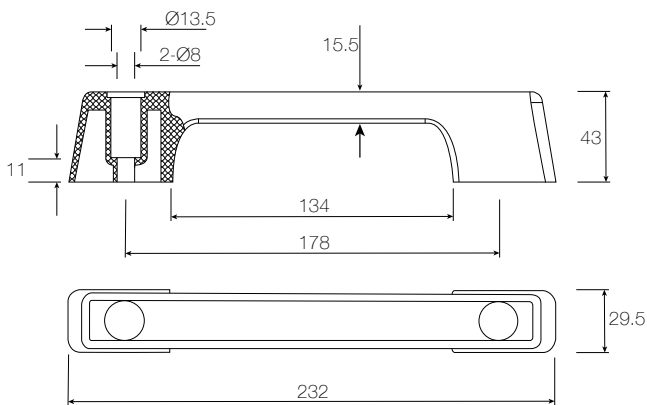

MATERIAL & FINISH:

Material Polyamide



COLOUR	PART NUMBER
Black	LS521