

Operation manual

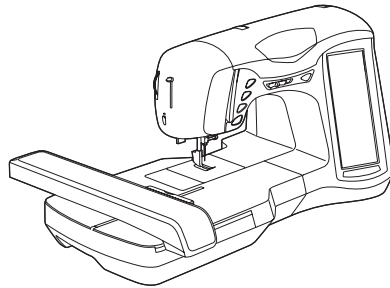

brother®

IMPORTANT SAFETY INSTRUCTIONS

When using this machine, basic safety precautions should always be taken, including the following:

Read all instructions before using.

DANGER - To reduce the risk of electric shock:

1. The machine should never be left unattended while plugged in. Always unplug the machine from the electrical outlet immediately after using and before cleaning.
2. Always unplug before changing the light bulb. Replace bulb with same type rated 12V 5 watts.

WARNING - To reduce the risk of burns, fire, electric shock, or injury to persons:

1. Do not allow this machine to be used as a toy. Close attention is necessary when the machine is used by or near children.
2. Use this machine only for its intended use as described in this manual. Use only accessories recommended by the manufacturer as contained in this manual.
3. Never operate this machine if it has a damaged cord or plug, if it is not working properly, if it has been dropped or damaged, or dropped into water. Return the machine to the nearest authorized dealer or service center for examination, repair, electrical or mechanical adjustment.
4. Never operate the machine with any air openings blocked. Keep ventilation openings of the machine and foot control free from the accumulation of lint, dust, and loose cloth.
5. Never drop or insert any object into any opening.
6. Do not use outdoors.
7. Do not operate where aerosol (spray) products are being used or where oxygen is being administered.
8. To disconnect, turn the main switch to the symbol "○" position which represents off, then remove plug from outlet.
9. Do not unplug by pulling on cord. To unplug, grasp the plug, not the cord.
10. Keep fingers away from all moving parts. Special care is required around the machine needle.
11. Always use the proper needle plate. The wrong plate can cause the needle to break.
12. Do not use bent needles.
13. Do not pull or push fabric while stitching. It may deflect the needle causing it to break.
14. Switch the machine to the symbol "○" position when making any adjustments in the needle area, such as threading needle, changing needle, threading bobbin, or changing presser foot, and the like.
15. Always unplug the machine from the electrical outlet when removing covers, lubricating, or when making any other user servicing adjustments mentioned in the instruction manual.
16. This sewing machine is not intended for use by young children or infirm persons without supervision.
17. Young children should be supervised to ensure that they do not play with this machine.

SAVE THESE INSTRUCTIONS

This machine is intended for household use.

FOR USERS IN THE UK, EIRE, MALTA AND CYPRUS ONLY

If this machine is fitted with a three-pin non-rewireable BS plug then please read the following.

IMPORTANT

If the available socket outlet is not suitable for the plug supplied with this equipment, it should be cut off and an appropriate three-pin plug fitted. With alternative plugs an approved fuse must be fitted in the plug.

NOTE

The plug served from the main lead must be destroyed as a plug with bared flexible cords is hazardous if engaged in a live socket outlet. In the event of replacing the plug fuse, use a fuse approved by ASTA to BS 1362, i.e. carrying the  mark, rating as marked on plug. Always replace the fuse cover, never use plugs with the fuse cover omitted.

WARNING

DO NOT CONNECT EITHER WIRE TO THE EARTH TERMINAL WHICH IS MARKED WITH THE LETTER 'E', BY THE EARTH SYMBOL  OR COLOURED GREEN OR YELLOW.

The wires in this main lead are coloured in accordance with the following code:

Blue Neutral

Brown Live

As the colours of the wiring in the main lead of this appliance may not correspond with the coloured markings identifying the terminals in your plug, proceed as follows.

The wire which is coloured blue must be connected to the terminal which is marked with the letter 'N' or coloured black or blue.

The wire which is coloured brown must be connected to the terminal which is marked with the letter 'L' or coloured red or brown.

CONGRATULATIONS ON CHOOSING OUR MACHINE

Your machine is the most advanced computerized household sewing machine. To fully enjoy all the features incorporated, we suggest that you study the manual.

PLEASE READ BEFORE USING THIS MACHINE

For safe operation

1. Be sure to keep your eye on the needle while sewing. Do not touch the pulley, thread take-up, needle, or other moving parts.
2. Remember to turn off the power switch and unplug the cord when:
 - Operation is completed
 - Replacing or removing the needle or any other parts
 - A power failure occurs during use
 - Maintaining the machine
 - Leaving the machine unattended.
3. Do not store anything on the foot controller.
4. Plug the machine directly into the wall. Do not use extension cords.

For a longer service life

1. When storing this machine, avoid direct sunlight and high humidity locations. Do not use or store the machine near a space heater, iron, halogen lamp, or other hot objects.
2. Use only neutral soaps or detergents to clean the case. Benzene, thinner, and scouring powders can damage the case and machine, and should never be used.
3. Do not drop or hit the machine.
4. Always consult the operation manual when replacing or installing any assemblies, the presser feet, needle, or other parts to assure correct installation.

For repair or adjustment

In the event a malfunction occurs or adjustment is required, first follow the troubleshooting table in the back of the operation manual to inspect and adjust the machine yourself. If the problem persists, please consult your local authorized Brother dealer.

For additional product information and updates, visit our web site at www.brother.com

WHAT YOU CAN DO WITH THIS MACHINE

Special Features

- On screen sewing advisor gives advice about sewing and general machine use, in addition to illustrated step-by-step instructions on the large LCD display.
- Machine sets thread tension automatically - no more bothersome trial sewing.
- Prepare the bobbin thread for sewing with one touch - no need to pull the bobbin thread up through the needle plate.
- Attach the knee lifter to raise and lower the presser foot without using your hands - convenient for quilting and patchwork.
- Wind the bobbin easily, even while the machine is embroidering.

Utility Stitches

There are 107 pre-programmed stitches in the machine, for garment construction or mending.

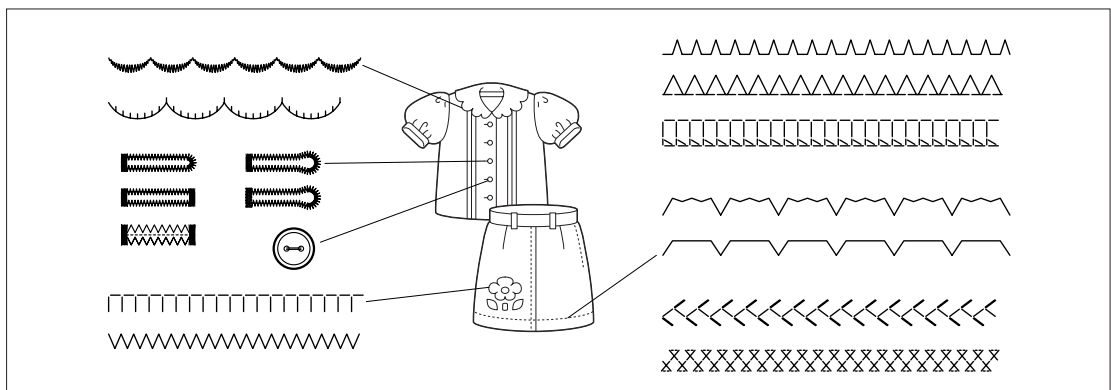

Character/Decorative Stitches

Sew alphabetical character patterns, decorative stitch patterns, satin stitch patterns, cross stitch patterns, and more.

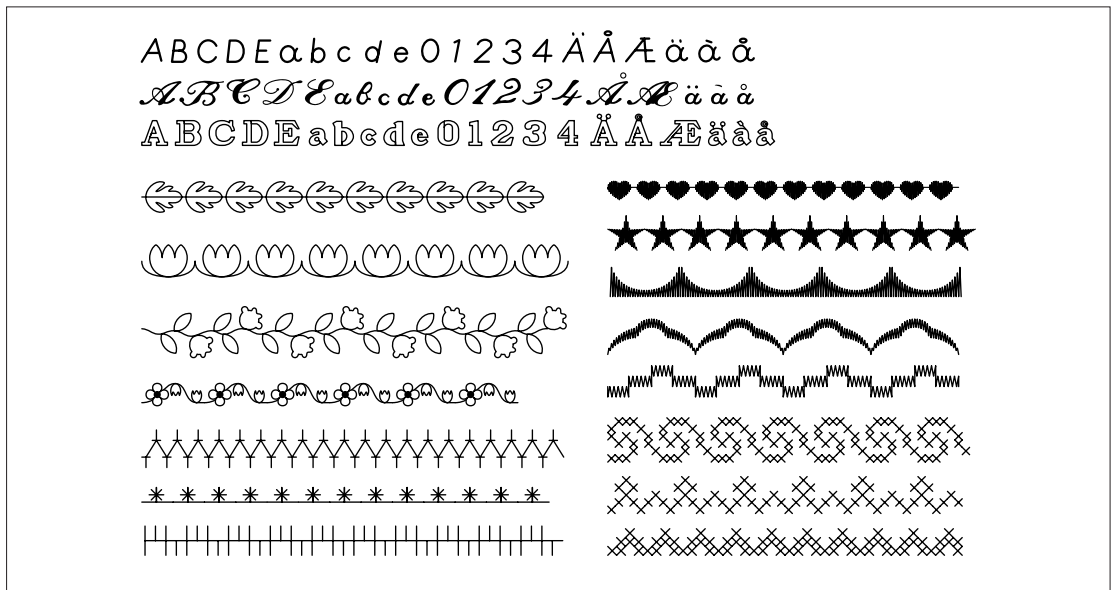

Attach the embroidery unit to enjoy sewing realistic embroidery patterns. Choose from the alphabetic (character) patterns, built-in designs, or decorative borders to frame your patterns pre-programmed into the machine, or choose from a wide selection of embroidery cards (sold separately) to increase creativity.

Embroidery

Select the "Embroidery" function icon to choose a pattern and sew it as it appears on the screen.



Embroidery Editing

You can combine characters and patterns, or change the configuration of characters easily with the "Embroidery Edit" functions.



HOW TO USE THIS MANUAL

Chapter 1 and Chapter 2 explain your sewing machine's basic operation procedures for someone who is using the sewing machine for the first time. If you want to sew utility stitches or character/decorative stitches, read Chapter 1 and Chapter 2, then go on to Chapter 3 (Sewing Utility Stitches) or Chapter 4 (Sewing Character/Decorative Stitches).

When you are ready to begin using the embroidery function after reading Chapter 1 and Chapter 2, proceed to Chapter 5 (Embroidery). Once you understand the steps explained in Chapter 5, go on to Chapter 6 for an explanation about the convenient embroidery edit functions.

In the screens that appear in the step-by-step directions the parts that are used for the operation are shown in . Compare the screen in the directions with the actual screen, and carry out the operation.

If, while using the machine, you experience something you do not understand, or there is a function you would like to know more about, refer to the index at the back of the operation manual in conjunction with the table of contents to find the section of the manual you should refer to.

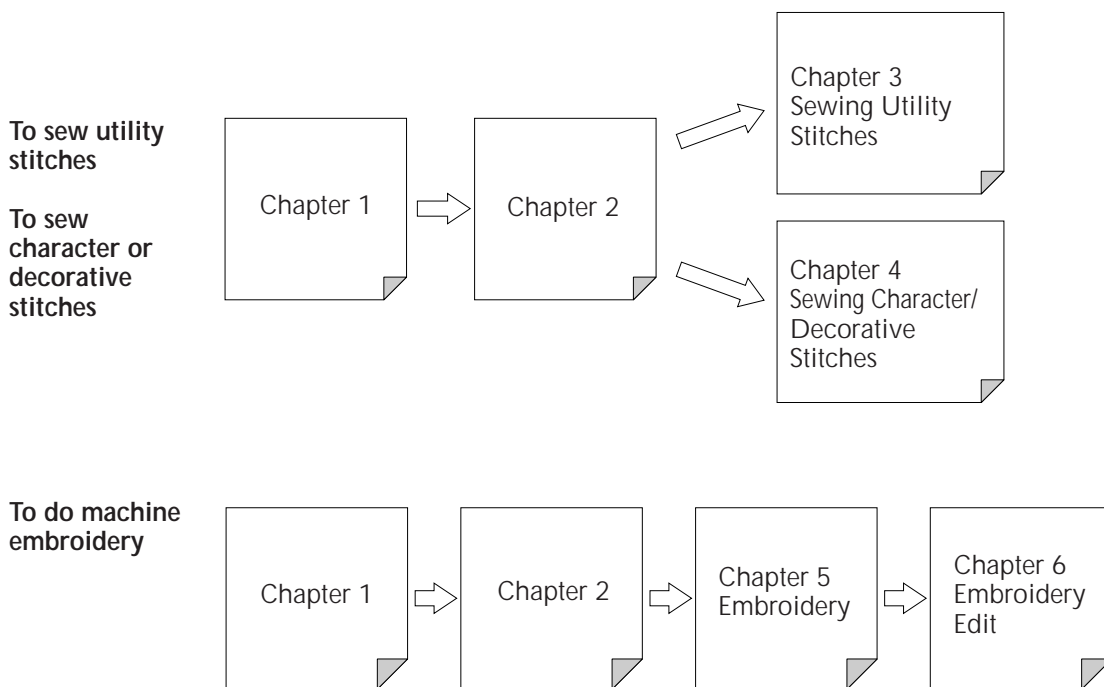

CONTENTS



WHAT YOU CAN DO WITH THIS MACHINE

Special Features

HOW TO USE THIS MANUAL

Chapter 1 Setting Up

PRINCIPAL PARTS AND THEIR OPERATION 1-1

Principal Parts	1-1
■ Embroidery Unit	1-2
■ Hard Case	1-2
■ Embroidery Unit Storage Case	1-2
■ Operation Buttons	1-3
■ Balance Wheel	1-4
■ Presser Foot Lever	1-4
■ Sewing Speed Controller	1-4
■ Bobbin Winder Button	1-4
■ Top Cover	1-5
■ Supplemental Spool Pin	1-5
■ Free Arm	1-5
■ Feed Dog Position Switch	1-6
■ Presser Foot Dial	1-6
■ Knee Lifter	1-6
■ Foot Controller	1-7
Included Accessories	1-8
Options	1-10
■ When Using the Multi-thread Stand	1-10

BASIC OPERATION 1-12

Connecting the Power	1-12
Viewing the LCD Display	1-13
■ Key Functions	1-14
Using the LCD Display	1-16
Adjusting Screen Brightness	1-16
Choosing the Display Language	1-18
Using the Machine Settings Key	1-19
Using the Machine Operations Key	1-20
■ Contents of Other Categories	1-22
Using the Pattern Explanation Key	1-24
Bobbin Winding/Lower Threading	1-25
■ Winding the Bobbin During Sewing	1-29
Setting the Bobbin	1-31
Upper Threading	1-32
■ Using the Spool Net	1-37
Pulling Up the Bobbin Thread	1-38
Changing the Presser Foot	1-39
■ Removing the Presser Foot	1-39
■ Attaching the Presser Foot	1-39

■ Attaching the Walking Foot	1-40
■ Reattaching the Presser Foot Holder ...	1-42
Changing the Needle	1-43
■ About the Needle	1-45
■ Fabric/Thread/Needle Combinations ..	1-45

Chapter 2 Getting Ready to Sew

TRIAL SEWING 2-1

Basic Sewing	2-1
Sewing Reinforcement Stitches	2-3
Changing Sewing Direction	2-3
Sewing Curves	2-3
Sewing Heavyweight Fabrics	2-4
Sewing Lightweight Fabrics	2-4
Using the Twin Needle Mode	2-5

STITCH SETTINGS 2-8

Setting Stitch Width for Zigzag Stitch Patterns	2-8
Setting the Stitch Length	2-9
■ Stitch Pattern Width/	
Stitch Length Settings Table	2-10
Setting the Thread Tension	2-13
■ Proper Thread Tension	2-13

MACHINE FUNCTION SETTINGS 2-14

Automatic Reinforcement Stitching	2-14
Using the Automatic Thread Cutter	2-15

Chapter 3 Sewing Utility Stitches

QUICK REFERENCE TABLE 3-1

SELECTING UTILITY STITCHES 3-9

Selecting a Stitch Pattern	3-9
■ Stitch Selection Screens	3-10
■ Using the Mirror Image Key	3-11
■ Saving Your Preferred Stitch Settings	3-12
Using the Sewing Type Selection Key ..	3-13

SEWING THE STITCHES 3-16

Straight Stitches	3-16
■ Changing the Needle Position	
(Left Needle Position Patterns Only)	3-18
Basting	3-19
Zigzag Stitches	3-20

- Overcasting (Using a Zigzag Stitch) 3-20
- Appliqué (Using a Zigzag Stitch) .. 3-21
- Patchwork (for Crazy Quilt) 3-21
- Sewing Curves
(Using a Zigzag Stitch) 3-21
- Elastic Zigzag Stitches 3-22
 - Tape Attaching 3-22
 - Overcasting 3-22
- Overcasting 3-23
 - Overcasting Using Presser Foot "G" 3-23
 - Overcasting Using Presser Foot "J" 3-24
 - Overcasting Using the Side Cutter 3-25
- Quilting 3-28
 - Piecing 3-29
 - Quilting 3-30
 - Appliqué 3-31
 - Quilting with Satin Stitches 3-33
- Blind Hem Stitches 3-35
 - If the Needle Does not Catch the
Fold 3-36
 - If the Needle Catches Too Much
of the Fold 3-36
- Appliqué 3-37
 - Sewing Sharp Curves 3-38
- Shelltuck Stitches 3-39
- Scallop Stitches 3-41
- Patchwork Stitches 3-42
- Smocking Stitches 3-44
- Fagoting 3-46
- Tape or Elastic Attaching 3-47
- Heirloom 3-49
 - Hemstitching (1) (Daisy stitch) 3-49
 - Hemstitching (2) (Drawn work) 3-50
 - Hemstitching (3) 3-52
- Buttonholes 3-53
 - Sewing Stretch Fabrics 3-56
 - Odd Shaped Buttons/Buttons that do
not Fit into the Button Holder Plate .. 3-56
- Darning 3-57
- Bar Tacks 3-59
- Button Sewing 3-61
 - Attaching 4 Hole Buttons 3-62
 - Attaching a Shank to the Button ... 3-63
- Eyelet 3-63
- Multi-directional Sewing
(Straight Stitch and Zigzag Stitch) 3-65
- Zipper Insertion 3-67
 - Centered Zipper 3-67
 - Inserting a Side Zipper 3-68

Chapter 4 Sewing Character/ Decorative Stitches

SELECTING A STITCH PATTERN 4-1

- Decorative Stitch Patterns 4-2
- 7mm Decorative Stitch Patterns 4-3
- Satin Stitch Patterns 4-3
- 7mm Satin Stitch Patterns 4-4
- Cross Stitch 4-4
- Utility Decorative Stitch Patterns 4-5
- Alphabetical Characters 4-6
 - If You Make a Mistake Selecting the
Character 4-7

SEWING CHARACTER/DECORATIVE STITCH PATTERNS 4-8

- Sewing Attractive Finishes 4-8
- Basic Sewing of Character/
Decorative Stitches 4-9
- Making Stitch Pattern Adjustments 4-11

EDITING CHARACTER/DECORATIVE STITCH PATTERNS 4-13

- Key Functions 4-14
- Changing the Size of the Stitch Patterns . 4-15
- Changing the Stitch Pattern Length
(for 7mm Satin Stitch Patterns Only) 4-16
- Creating a Vertical Mirror Image 4-16
- Creating a Horizontal Mirror Image..... 4-16
- Sewing Pattern Continuously 4-17
 - When Sewing the Pattern Continuously 4-17
 - When Sewing Single Stitches 4-17

COMBINING STITCH PATTERNS 4-18

- Before Combining Stitch Patterns 4-18
- Combining Decorative Stitch and
Character Stitch Patterns 4-18
- Combining Large and Small Stitch
Patterns 4-20
- Combining Horizontal Mirror Image
Stitch Patterns 4-21
- Combining Stitch Patterns of Different
Lengths 4-22
- Making Step Stitch Patterns
(for 7mm Satin Stitch Patterns Only) 4-23
 - More Examples 4-25
- Checking Combined Stitch Patterns..... 4-26

MEMORY FUNCTIONS 4-27





Saving Stitch Patterns 4-27
 ■ If You Can Not Save the Stitch Pattern 4-28
 Retrieving Saved Stitch Patterns 4-31

Chapter 5 Embroidery

PREPARING TO EMBROIDER 5-1

Before Beginning 5-1
 ■ Copyright Information 5-1
 ■ About the Embroidery Unit 5-1
 ■ About Embroidery Cards (Sold Separately) 5-1
 ■ About Floppy Disks 5-2

BASIC EMBROIDERY 5-3

Attaching Embroidery Foot “Q” 5-4
 Attaching the Embroidery Unit 5-5
 ■ Removing the Embroidery Unit 5-7

SELECTING PATTERNS 5-8

One Point Patterns 5-9
 Character Patterns 5-11
 Floral Alphabet Patterns 5-13
 Frame Patterns 5-15
 Selecting Patterns from an Embroidery Card 5-17
 Selecting a Pattern from a Floppy Disk (Only for Machines with Floppy Disk Drives) .. 5-18

VIEWING THE SEWING SCREEN 5-19

PREPARING THE EMBROIDERY FRAME 5-20

Attaching a Stabilizer Material to the Fabric 5-20
 Setting the Fabric in the Embroidery Frame 5-21
 ■ Inserting the Fabric 5-22
 ■ Using the Embroidery Sheet 5-23
 Attaching the Embroidery Frame 5-24
 ■ Removing the Embroidery Frame .. 5-25

DETERMINING THE PATTERN POSITION 5-26

Changing the Pattern Position 5-26
 Checking the Pattern’s Position 5-27
 Previewing the Completed Pattern 5-28

SEWING AN EMBROIDERY PATTERN 5-29

Sewing Attractive Finishes 5-29
 ■ Needle Plate Cover 5-29
 Basic Embroidery Method 5-30
 ■ Embroidering Order for Pattern Parts .. 5-32
 Sewing Embroidery Patterns Which Use Appliqué 5-33
 ■ Directions for Appliqué 5-33

ADJUSTMENTS DURING THE EMBROIDERY PROCESS 5-35

The Bobbin Runs Out of Thread 5-35
 The Thread Breaks During Sewing 5-36
 Sewing Again from the Beginning 5-38
 Continuing Embroidery After Turning off the Power 5-39

MAKING EMBROIDERY ADJUSTMENTS .. 5-40

Adjusting Thread Tension 5-40
 ■ Correct Thread Tension 5-40
 ■ If the Upper Thread Tension is Too Strong 5-40
 ■ If the Upper Thread Tension is Too Weak 5-41
 Adjusting the Embroidery Speed 5-41
 Changing the Thread Color Display 5-42
 Changing the Embroidery Frame Display 5-43

REVISING THE PATTERN 5-44

■ Key Functions 5-44
 Changing the Size of the Pattern 5-45
 Rotating the Pattern 5-46
 Creating a Horizontal Mirror Image 5-46
 Changing the Density of a Pattern (Character and Border Patterns Only) .. 5-47
 Changing the Colors of Character Patterns 5-48

MEMORY FUNCTION 5-49

Saving Embroidery Patterns 5-49
 ■ Saving a Pattern 5-49
 ■ If You Can Not Save the Pattern 5-50
 Retrieving Patterns from Memory 5-53

EMBROIDERY APPLICATIONS 5-55

Aligning the Left Side of a Pattern and Sewing 5-55
 Connecting Characters 5-56
 Embroidering an Outline of a Pattern .. 5-58

Using a Frame Pattern to Make Appliqué (1)	5-59
Using a Frame Pattern to Make Appliqué (2)	5-60
Embroidering Small Fabrics or Fabric Edges	5-62

Chapter 6 Embroidery Edit Functions

EXPLANATION OF THE EDITING FUNCTIONS	6-1
---	-----

SELECTING PATTERNS TO EDIT	6-2
---	-----

Selecting Character Patterns	6-5
------------------------------------	-----

EDITING EMBROIDERY PATTERNS	6-8
--	-----

■ Key Functions	6-8
Moving the Pattern	6-9
Rotating the Pattern	6-10
Changing the Size of the Pattern	6-11
Deleting the Pattern	6-12
Changing the Thread Color	6-13
Changing the Configuration of Character Patterns	6-15
Changing Character Spacing	6-16
Changing the Color of Each Character in a Pattern	6-17

ADJUSTING PATTERNS AFTER EDITING ..	6-18
--	------

COMBINING AND EDITING PATTERNS ..	6-20
--	------

SEWING COMBINED EMBROIDERY PATTERNS	6-28
--	------

ADJUSTING EDITED PATTERNS	6-30
--	------

MEMORY FUNCTIONS	6-32
-------------------------------	------

Saving Edited Patterns	6-32
■ Saving a Pattern	6-32
■ If You Can Not Save the Pattern	6-33
Retrieving Saved Patterns	6-36

Chapter 7 MY CUSTOM STITCH

DESIGNING THE STITCH	7-1
-----------------------------------	-----

ENTERING STITCH DATA	7-3
-----------------------------------	-----

Creating Stitch Data	7-3
Editing Stitch Data	7-6
■ Moving a Point	7-7
■ Moving Part or All of the Design	7-8
■ Inserting New Points	7-9

MEMORY FUNCTIONS	7-11
-------------------------------	------

Storing the custom design	7-11
Retrieving a Stitch Design That Has Been Saved	7-13

Chapter 8 Care and Maintenance

CHANGING THE LIGHT BULB	8-1
--------------------------------------	-----

CLEANING THE MACHINE	8-2
-----------------------------------	-----

■ Cleaning the LCD Screen	8-2
■ Cleaning the Machine Casing	8-2
■ Cleaning the Race and Shuttle	8-2

CLEANING THE FLOPPY DISK DRIVE HEADS	8-4
---	-----

Chapter 9 Troubleshooting

ADJUSTING THE SCREEN	9-1
-----------------------------------	-----

ADJUSTING THE TOUCH PANEL	9-2
--	-----

USING THE "TROUBLESHOOTING" FUNCTION	9-4
---	-----

MAKING MINOR MACHINE ADJUSTMENTS	9-5
---	-----

ERROR MESSAGES	9-10
-----------------------------	------

■ Alarm Sounds	9-15
----------------------	------

Appendix

SPECIFICATIONS	A-1
-----------------------------	-----

Index

1 —



2 —



3 —



4 —



5 —



6 —



7 —



8 —



9 —



Chapter 1 Setting Up

PRINCIPAL PARTS AND THEIR OPERATION

Principal Parts

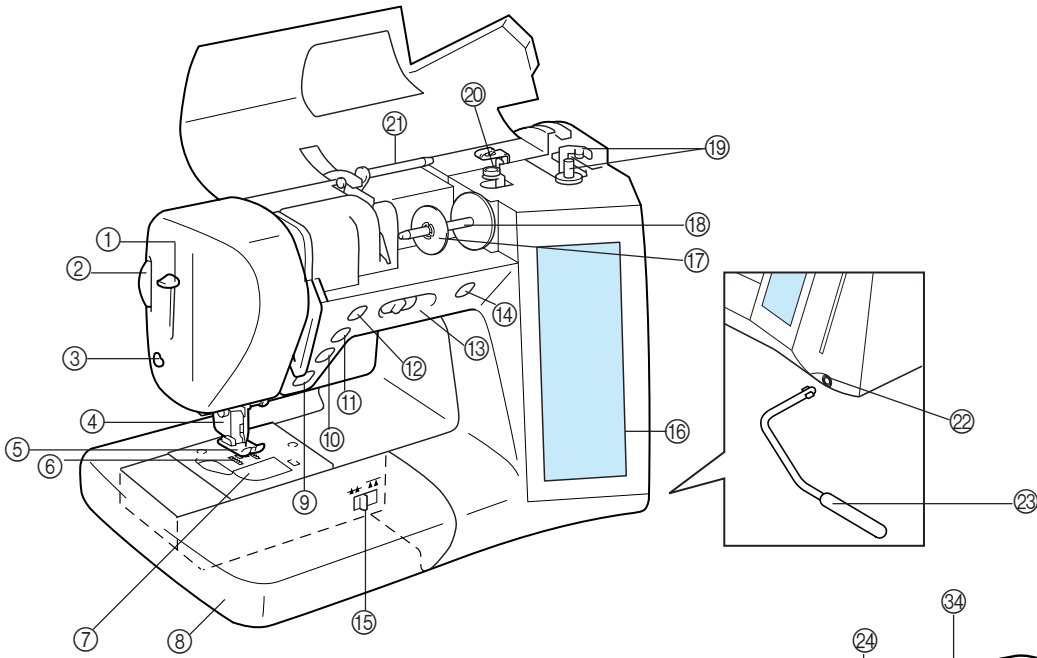

- ① Needle threader lever
- ② Presser foot dial
- ③ Thread cutter
- ④ Presser foot holder
- ⑤ Presser foot
- ⑥ Feed dogs
- ⑦ Bobbin cover
- ⑧ Flat bed attachment with accessory compartment
- ⑨ "Start/Stop" button
- ⑩ "Reverse/Reinforcement Stitch" button
- ⑪ "Needle Position" button
- ⑫ "Thread Cutter" button
- ⑬ Sewing speed controller
- ⑭ "Bobbin Winder" button
- ⑮ Feed dog position switch
- ⑯ L.C.D. (liquid crystal display)
- ⑰ Spool cap
- ⑱ Spool pin
- ⑲ Bobbin winder
- ⑳ Thread guide for bobbin winding
- ㉑ Supplemental spool pin
- ㉒ Knee lifter mounting slot
- ㉓ Knee lifter

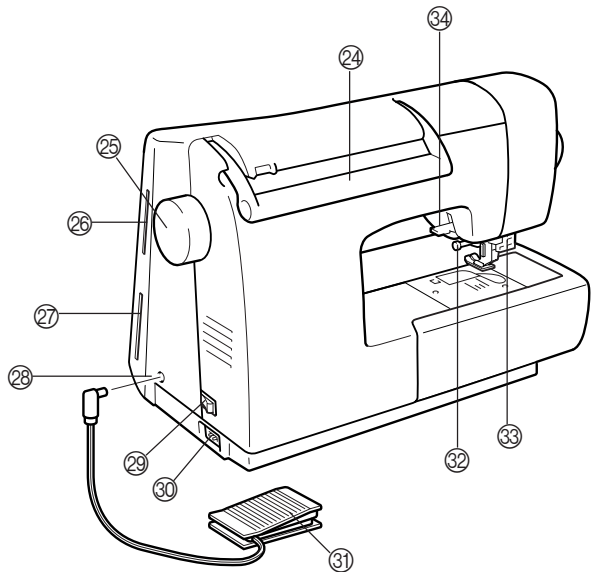

- ⑳ Handle
- ㉑ Balance wheel
- ㉒ Embroidery card slot
- ㉓ Floppy disk drive slot
- ㉔ Foot controller jack
- ㉕ Main power switch
- ㉖ Cord jack
- ㉗ Foot controller
- ㉘ Needle clamp lever
- ㉙ Buttonhole lever
- ㉚ Presser foot lever

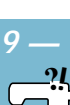
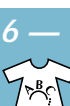

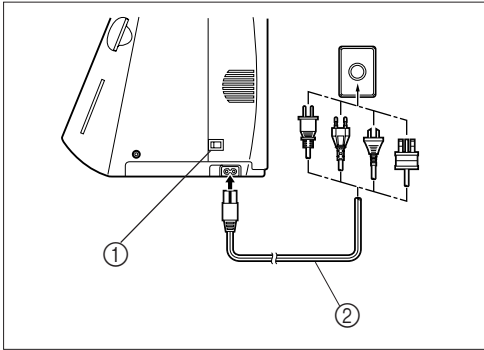

- ① Main power switch
- ② Power cord

CAUTION

- When leaving the machine unattended, the main switch of the machine should be switched off or the plug must be removed from the socket-outlet.
- When servicing the machine, or when removing covers or changing bulbs, the machine or the electrical set must be unplugged.
- For U.S.A. only

This appliance has a polarized plug (one blade wider than the other). To reduce the risk of electrical shock, this plug is intended to fit in a polarized outlet only one way.

If the plug does not fit fully in the outlet, reverse the plug. If it still does not fit, contact a qualified electrician to install the proper outlet. Do not modify the plug in any way.

■ Embroidery Unit

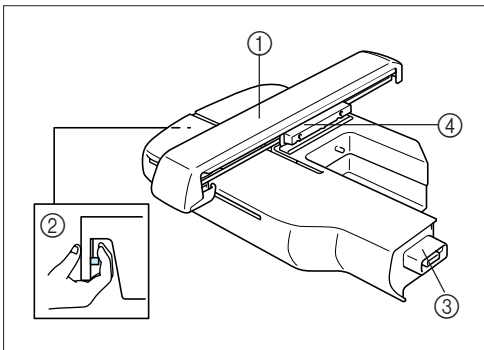

- ① Carriage
- ② Release button
- ③ Embroidery unit connection
- ④ Embroidery frame holder

■ Hard Case

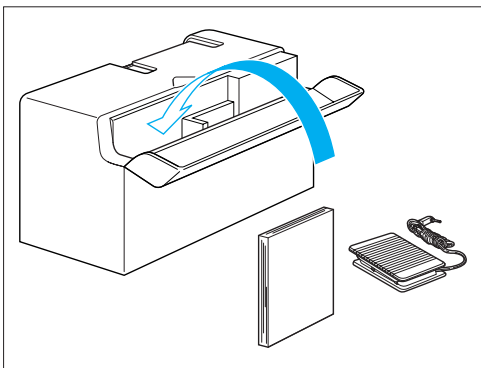

■ Embroidery Unit Storage Case

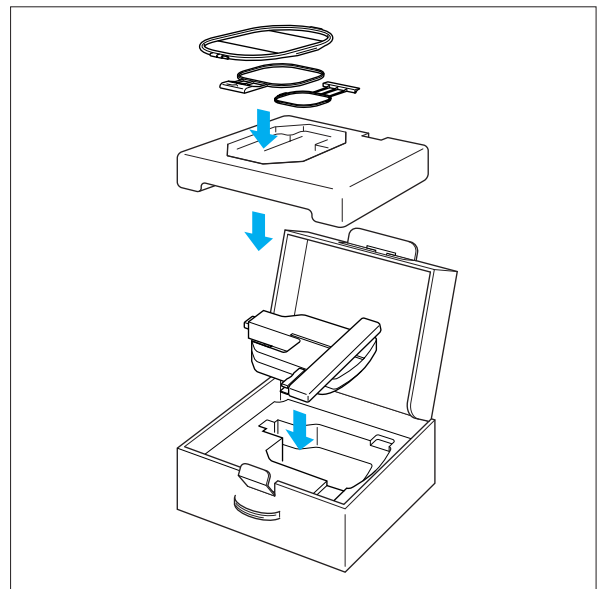



■ Operation Buttons

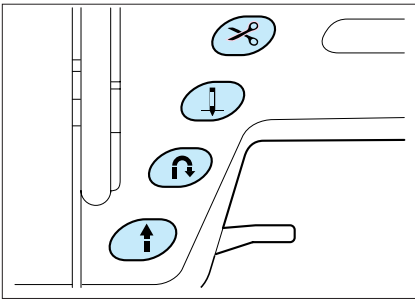
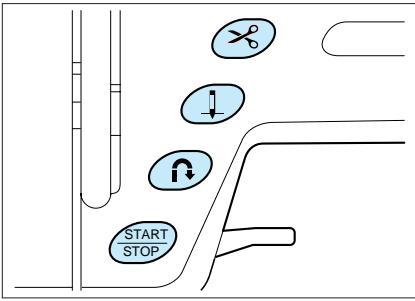

"Thread Cutter" Button

Press this button after sewing to automatically trim the excess thread.

CAUTION

Do not repeat thread cutting after the threads are cut. The thread may tangle or the needle may break, resulting in damage.

CAUTION

- Do not press the "Thread Cutter" button when there is no fabric in the machine or during machine operation. The thread may tangle resulting in damage.
- When cutting thread thicker than #30, nylon thread, or other specialty threads, use the thread cutter on the side of the machine.

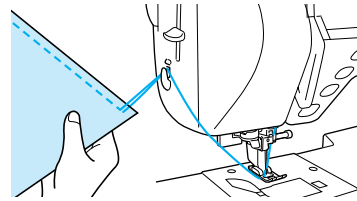

"Needle Position" Button

Use this button when changing sewing direction or for detailed sewing in small areas. Press this button to raise or lower the needle position. Press the button twice to sew a single stitch.

"Reverse/Reinforcement Stitch" Button

Use this button to sew reinforcement stitches at the beginning and end of sewing. Press this button, and the machine sews 3 stitches in the same spot and stops automatically. For straight and zigzag stitch patterns that take reverse stitches, the machine will sew reverse stitches at low speed only while holding down the "Reverse/Reinforcement Stitch" button (the stitches are sewn in the opposite direction from the main seam). (See page 2-3.)

"Start/Stop" Button

Press this button and the machine will sew a few stitches at a slow speed, then begin sewing at the speed set by the sewing speed controller. Press the button again to stop the machine. Hold the button down to sew at the machine's slowest speed. The button changes color according to the machine's operation mode.

Green : the machine is ready to sew or is sewing.

Red : the machine can not sew.

Balance Wheel

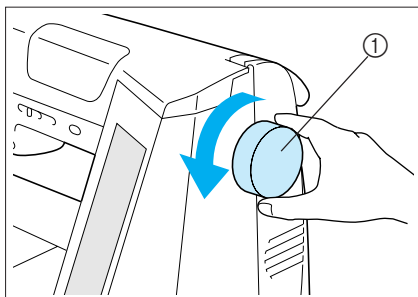

Turn the balance wheel to raise or lower the needle. The wheel should be turned toward the front of the machine.

- ① Balance wheel

Presser Foot Lever

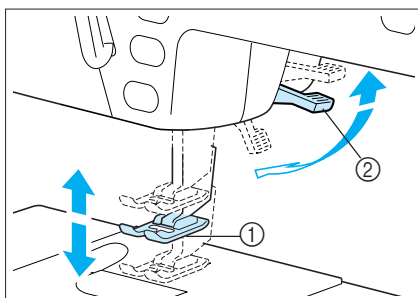

Lower the presser foot lever to lower the presser foot and apply pressure to the fabric. If the presser foot is raised to the second position, and you want to sew heavy weight, stacked fabrics, etc., that are hard to set under the presser foot, raise the presser foot lever higher and hold it to make room for the fabric (see page 2-4).

- ① Presser foot
② Presser foot lever

CAUTION

The machine will not operate with the presser foot raised.

Sewing Speed Controller

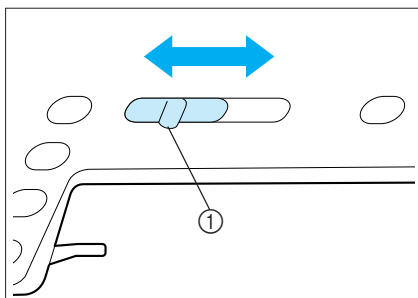

Use this controller to adjust the sewing speed. Move the lever to the left to sew at slower speeds. Move the lever to the right to sew at higher speeds.

- ① Lever

Note

Beginners should sew at a slow speed.

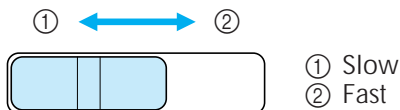

- ① Slow
② Fast

Bobbin Winder Button

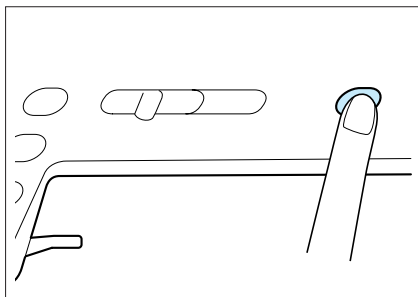

Use this button to wind the bobbin (see page 1-25).

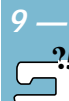

■ Top Cover

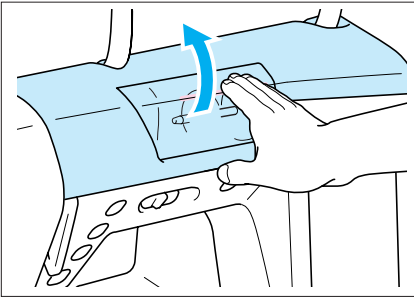

Open the top cover to wind the bobbin or do the upper threading. To open the cover, place your hand under the clear section of the cover and lift up.

■ Supplemental Spool Pin

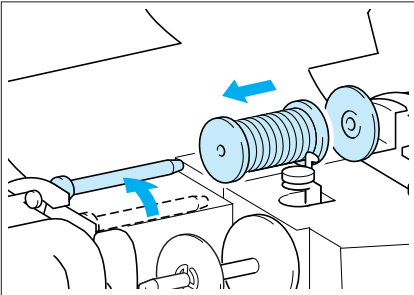

Use this spool pin to wind the bobbin thread during sewing, or when sewing with the twin needle (see pages 1-29, 2-5).

■ Free Arm

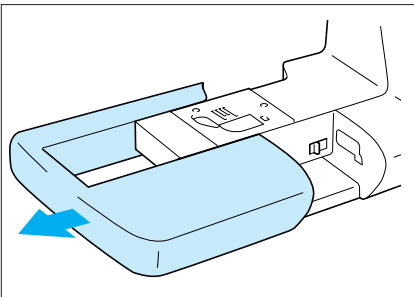

Use the free arm sewing option to attach cuffs, hem pant legs, and sew other tubular pieces. Pull the flat bed attachment to the left to remove it and create the convenient free arm sewing mode.



■ Feed Dog Position Switch

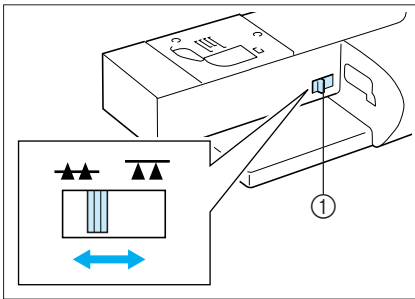

Use this switch when attaching buttons (see page 3-61) or for other similar projects. Remove the flat bed attachment and raise the presser foot lever to operate the feed dog position switch. Set the lever in the **▲▲** position for normal sewing

① Feed dog position switch

▲▲ The feed dogs are up and will help guide the fabric.

▲▲ The feed dogs are down and will not help guide the fabric.

■ Presser Foot Dial

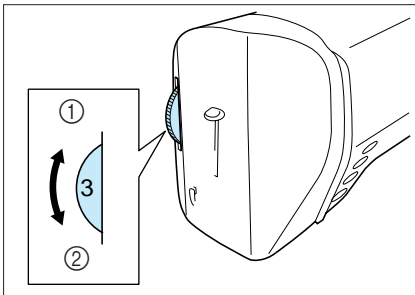

Turn the presser foot dial in order to increase or decrease the pressure depending on the weight of your fabric. Higher the number stronger the pressure will be. Use setting "3" for normal sewing.

① Weak

② Strong

■ Knee Lifter

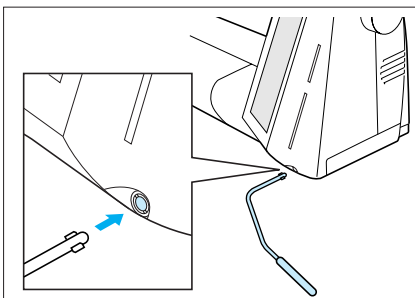

The knee lifter is convenient when piecing quilts or other similar projects, as well as free motion quilting and embroidery.

Align the knee lifter with the mounting slot and insert. The knee lifter is used to raise and lower the presser foot without using your hands.

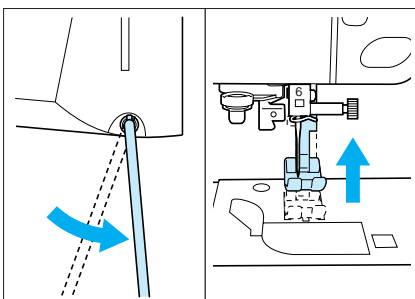

Use your knee to move the knee lifter to the right in order to raise the presser foot. Release to the left for the presser foot to lower.



■ Foot Controller

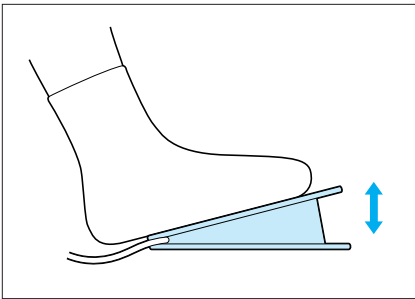
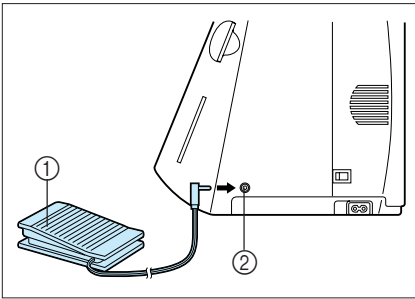

▲ CAUTION

Do not allow fabric pieces and dust to collect in the foot controller. Doing so could cause a fire or an electric shock.

1. With this machine turned off, insert the foot controller into its jack on this machine.

- ① Foot controller
- ② Foot controller jack

2. Switch on the machine, then slowly depress the foot controller to start sewing.

* The speed set using the sewing speed controller is the foot controller's maximum sewing speed.

3. Release the foot controller to stop this machine.

* When the foot controller is being used, the "Start/Stop" button has no effect on the sewing.

Note (For U.S.A. only)

Foot controller: Model P

This foot controller can be used on this machine model ULT2001.



Included Accessories

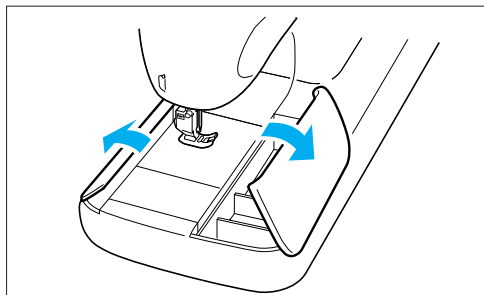

Pull the top of the flat-bed attachment towards you to open the accessory compartment.

- ① Storage space
- ② Presser foot storage space
- ③ Bobbin storage space

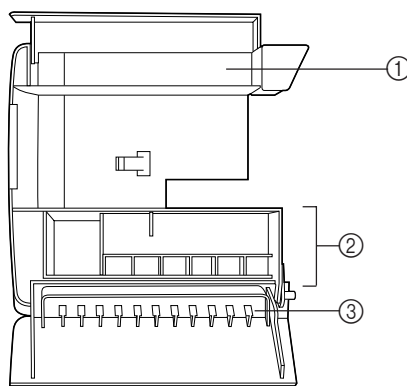

75/11 2 needles
 90/14 2 needles
 90/14 2 needles : Ball point needle
 (gold colored)

No.	Part Name	Part Code	
		U.S.A.	Others
1	Buttonhole foot "A"	X57789-101	
2	Embroidery foot "Q"	XA5500-001	
3	Overcasting foot "G"	X51162-001	
4	Monogramming foot "N "	X53840-301	
5	Zipper foot "I"	X59370-051	
6	Zigzag foot "J"	137748-101	
7	Blind stitch foot "R"	X56409-001	
8	Button fitting foot "M"	130489-001	
9	Walking foot	SA140	X81065-002
10	Side Cutter	X80943-001	
11	Seam ripper	X54243-001	
12	Bobbin	SA-155	XA3812-051
13	Needle set	X58358-001	
14	Twin needle	X59296-001	

Note

- The machine comes with zigzag foot "J" attached.
- Always use accessories recommended for this machine.



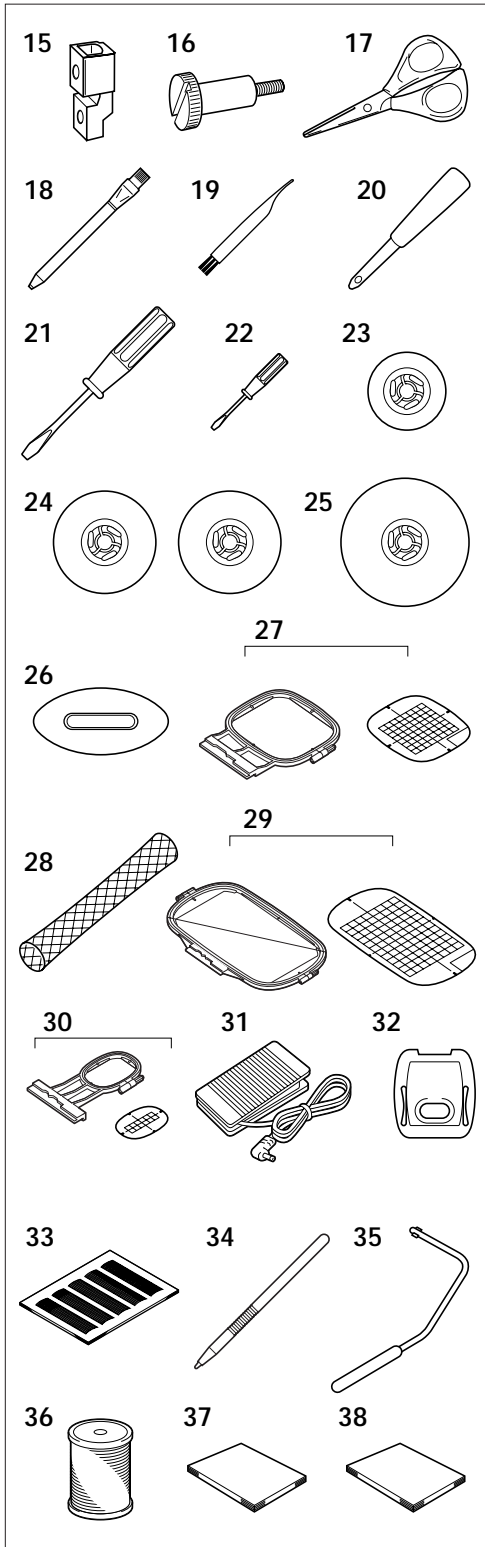

No.	Part Name	Part Code	
		U.S.A.	Others
15	Low shank adapter	SA131	XA6126-002
16	Screw (large)	XA5904-051	
17	Scissors	184783-001	
18	Chalk pen	184944-001	
19	Cleaning brush	XA4527-001	
20	Eyelet punch	135793-001	
21	Screwdriver (large)	X55467-051	
22	Screwdriver (small)	X55468-051	
23	Spool cap (small)	130013-004	
24	Spool cap (medium) × 2	X55260-053	
25	Spool cap (large)	130012-004	
26	Disc-shaped screwdriver	XA2005-051	
27	Embroidery set (regular) H 10 cm × W 10 cm (H 4 inch × W 4 inch)	SA427	X81273-002
28	Spool net	127610-000	
29	Embroidery set (large) H 26 cm × W 16 cm (H 10-1/4 inch × W 6-1/4 inch)	SA428	X81274-002
30	Embroidery set (small) H 2 cm × W 6 cm (H 1 inch × W 2-1/2 inch)	SA426	X81275-002
31	Foot controller	120V 230V	XA7290-051 XC0309-001
32	Needle plate cover	XA9939-051	
33	Grid sheet set	SA507	X81277-001
34	Touch pen	XA9949-001	
35	Knee lifter	XA6941-001	
36	Embroidery bobbin thread	SA-EBT	XA8375-001
37	Operation manual	191200-011	
38	Quick reference guide	192200-011	

Note (For U.S.A. only)

Foot controller: Model P

This foot controller can be used on this machine model ULT2001.

The screw of the presser foot holder is available through your authorized dealer (Part code XA4813-051).



Options

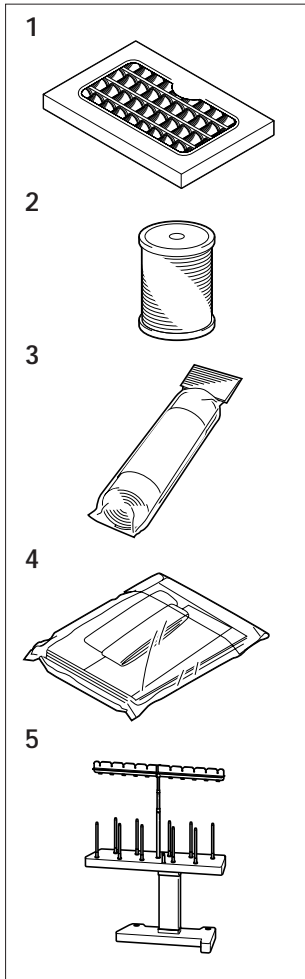

No.	Part Name	Part Code	
		U.S.A.	Others
1	40 colors embroidery threads	SA740	X80928-100
	40 colors country threads	CYT40	X81078-102
	22 colors embroidery threads	SA741	X81276-102
	21 colors country threads	CYT41	X81269-102
2	Embroidery bobbin thread	SA-BTS	XA8375-001
3	Stabilizer material	SA519	X81175-001
	Water soluble stabilizer	SA520	X81267-001
4	Country bag	SA152	X80922-002
5	Multi-thread stand	SA503	X81123-001

■ When Using the Multi-thread Stand

- Using the Multi-thread Stand When Placed Behind the Sewing Machine: Do not pass the thread through the thread guide on the multi-thread stand. Pass the thread through the thread guide of the sewing machine, then pass the thread around the thread guide plate.

① Thread guide of the sewing machine

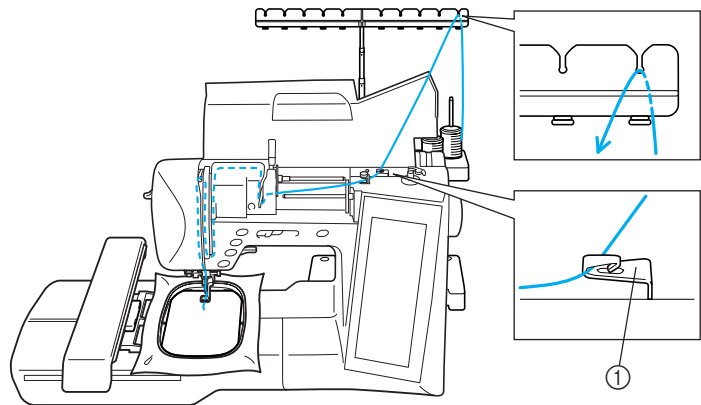

- Using the Multi-thread Stand When Placed to the Right of the Sewing Machine :

Do not pass the thread through the thread guide on the multi-thread stand, or through the thread guide on the sewing machine. Pass the thread directly around the thread guide plate.

② Thread guide on the multi-thread stand

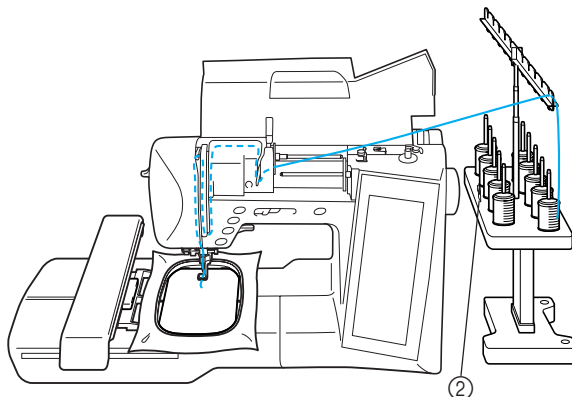

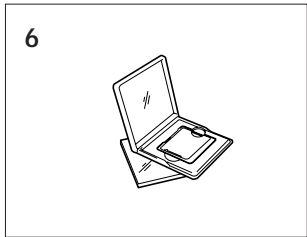

CAUTION
Embroidery card purchased in foreign countries may not work with your machine.

No.	Part Name	Part Code	
		U.S.A.	Others
6	Embroidery card		
	No. 1 Alphabet	SA298	X58317-001
	No. 2 Flower	SA299	X58321-001
	No. 3 Dinosaur	SA300	X58362-001
	No. 6 Moskowit's World	SA303	X58497-001
	No. 7 Country Life	SA304	X59322-001
	No. 8 Holiday	SA305	X59357-001
	No. 9 Hobby Craft	SA306	X59511-001
	No. 10 Monogram Emblem	SA307	X59567-001
	No. 11 Frame	SA311	XA0257-001
	No. 12 Transportation	SA312	XA0275-001
	No. 13 Sports Emblem	SA313	XA0517-001
	No. 14 Large Floral	SA314	XA1223-001
	No. 15 Cute Kids	SA315	XA1325001
	No. 16 Dogs & Cats	SA316	XA1406-001
	No. 19 Marine	SA319	XA2452-001
	No. 20 Petite Designs	SA320	XA2869-001
	No. 21 Needlework	SA321	XA2873-001
	No. 22 Large Quilt	SA322	XA3431-001
	No. 23 White on White	SA323	XA3430-001
	No. 25 Horse	SA325	XA3791-001
	No. 27 Birds	SA327	XA4289-001
	No. 28 Christmas	SA328	XA4502-001
	No. 29 Lace	SA329	XA4664-001
	No. 30 Wildlife Animals	SA330	XA4771-001
	No. 31 Large Flower II	SA331	XA5037-001
	No. 32 Musical Instrument	SA332	XA5386-001
	No. 33 Trees	SA333	XA5567-001
	No. 35 Cats & Dogs II	SA335	XA5629-001
	No. 36 Fruits & Vegetables	SA336	XA5659-001
	No. 37 Appliqué Alphabet	SA337	XA5753-001
	No. 38 Angel	SA338	XA5781-001
	No. 39 Doll Face	SA339	XA5978-001
	No. 40 Sports 3	SA340	XA6111-001
	No. 41 Renaissance Alphabet	SA341	XA6586-001
	No. 42 Farm	SA342	XA6733-001
	No. 43 Victorian	SA343	XA6769-001
	No. 44 Lace2	SA344	XA6849-001
	No. 45 Fancy Work	SA345	XA7770-001
	No. 46 Australian Animals	SA346	XA7893-001
	No. 47 Butterfly	SA347	XA8206-001
	No. 48 Australian Flowers	SA348	XA8250-001
	No. 49 Folk Art	SA349	XA8348-001
	No. 50 Fairy & Floral	SA350	XA8414-001
	No. 52 Bear Collections	SA352	XA8511-001
	No. 53 Scene	SA353	XA8936-001
	No. 54 Tea Time	SA354	XA9129-001
	No. 55 Gardening	SA355	XA9348-001
	No. 56 Asian	SA356	XC0025-001
	No. 57 Large Christmas	SA357	XC0057-001



Connecting the Power

▲ WARNING

- Use only regular household electricity for the power source. Using other power sources may result in fire, electric shock, or damage to the machine.
- Turn off the main power and remove the plug in the following circumstances:
 - When you are away from the machine
 - After using the machine
 - When the power fails during use
 - When the machine does not operate correctly due to a bad connection or a disconnection
 - During electrical storms

▲ CAUTION

- Do not use extension cords or multi-plug adapters with many other appliances plugged in to them. Fire or electric shock may result.
- Do not touch the plug with wet hands. Electric shock may result.
- When unplugging the machine, always turn off the main power first. Always grasp the plug to remove it from the outlet. Pulling on the cord may damage the cord, or lead to fire or electric shock.
- Do not allow the power cord to be cut, damaged, modified, forcefully bent, pulled, twisted, or bundled. Do not place heavy objects on the cord. Do not subject the cord to heat. These things may damage the cord and cause fire or electric shock. If the cord or plug is damaged, take the machine your authorized dealer for repairs before continuing use.
- Unplug the power cord if the machine is not to be used for a long period of time. Otherwise a fire may result.

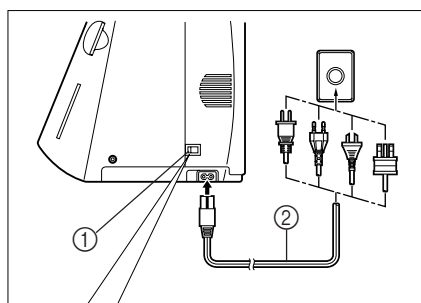

1. Insert the power cord into the cord jack, then insert the plug into a wall outlet.

- ① Main power switch
- ② Power cord

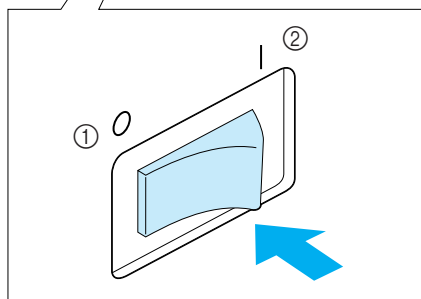

2. Turn the main power switch to "I" to turn on the machine.

- ① OFF
- ② ON

3. Turn the main power switch to "O" to turn off the machine.

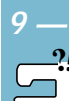

Viewing the LCD Display

When switching on machine, the screen will display the name of the machine. Touch the screen to display the utility stitch. The often used "Straight stitch (left)" (1-01) is automatically selected.

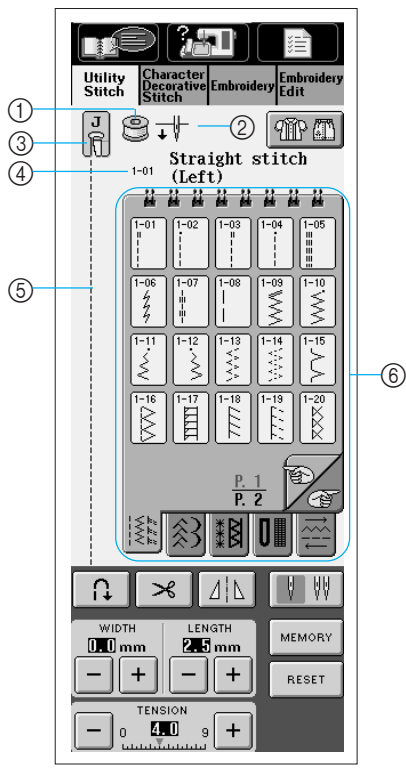

- ① Shows the amount of thread remaining in the bobbin during sewing. If the display is yellow, the bobbin is running out of thread.

Note
This bobbin symbol does not show the amount of bobbin thread remaining when the machine is not sewing.

- ② Shows single or twin needle mode setting, and the needle stop position.

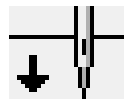

Single needle/
down position

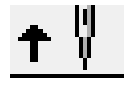

Single needle/
up position





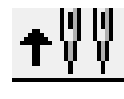









Twin needle/
down position





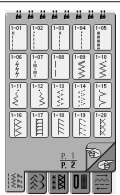

Twin needle/
up position

- ③ Presser foot code. Attach the presser foot indicated in this display before sewing.
- ④ Shows the name and code number of the selected stitch.
- ⑤ Shows a preview of the selected stitch.
- ⑥ To select, press the key of the stitch pattern you want to sew.

■ Key Functions

Display	Key Name	Explanation	Page
	Pattern explanation key	Press this key to see an explanation of the selected pattern.	1-24
	Operation guide key	Press this key to see explanations for upper threading, winding the bobbin, changing the presser foot, and how to use the machine.	1-20
	Setting key	Press this key to change the needle stop position, turn the buzzer ON/OFF, adjust the pattern or screen, and change other machine settings.	1-19
	Utility stitch key	Press this key to select a straight stitch, zigzag stitch, button-hole, blind hem stitch, or other stitches commonly used in garment construction.	3-9
	Character/Decorative stitch key	Press this key to select character or decorative stitch patterns, or use the My Custom Stitch™ function to create your own stitch patterns.	4-1
	Embroidery key	Attach the embroidery unit and press this key. (Caution: the Embroidery screen will not display if the embroidery unit is not attached.) Press this key to sew embroidery.	5-5
	Embroidery edit key	Attach the embroidery unit and press this key. (Caution: the Embroidery Edit screen will not display if the embroidery unit is not attached.) Press this key to combine embroidery patterns. With the embroidery edit functions, you can also create original one point patterns or frame patterns.	6-2
	Sewing type selection key	Press this key when you do not know which stitch pattern to select, and get help selecting the appropriate stitch pattern for the sewing application, and instructions on how to sew the stitch pattern. This key is very useful for beginners.	3-13
	Stitch selection display	Stitch Pattern Selection Screen Press the key of the pattern you want to sew. Use the  to change selection screens.	3-10
	Automatic reinforcement stitch key	Press this key to use the automatic reinforcement stitching (reverse stitching) setting. If you select this setting before sewing the machine will automatically sew reinforcement stitches at the beginning and end of sewing (depending on the pattern, the machine may sew reverse stitches).	2-14
	Automatic thread cutting key	Press this key to set the automatic thread cutting function. Set the automatic thread cutting function before sewing to have the machine automatically sew reinforcement stitches at the beginning and end of sewing (depending on the pattern, the machine may sew reverse stitches) and trim the threads after sewing.	2-15
	Mirror image key	Press this key to create a mirror image of the selected stitch pattern. If the key display is light gray, a mirror image of the selected stitch pattern cannot be sewn.	3-11



Display	Key Name	Explanation	Page
	Needle mode selection key (single/double)	Press this key to select twin needle sewing mode. The sewing mode changes between single needle mode and twin needle mode each time you press the key. If the key display is light gray, the selected stitch pattern can not be sewn in twin needle mode.	2-5
	Stitch width and stitch length key	Shows the zigzag width and stitch length settings of the currently selected stitch pattern. You can use the plus and minus keys to adjust the zigzag width and stitch length settings.	2-8
	Thread tension key	Shows the thread tension setting of the currently selected stitch pattern. The thread tension is usually set automatically. You can use the plus and minus keys to change the thread tension settings.	2-13
	Manual memory key	Change the stitch pattern settings as you like (zigzag width and stitch length, thread tension, automatic thread cutting or automatic reinforcement stitching, etc.), then save them by pressing this key.	3-12
	Reset key	Press this key to return the selected stitch pattern's saved settings to the original settings.	3-12

1 —



2 —



3 —



4 —



5 —



6 —



7 —



8 —



9 —



Using the LCD Display

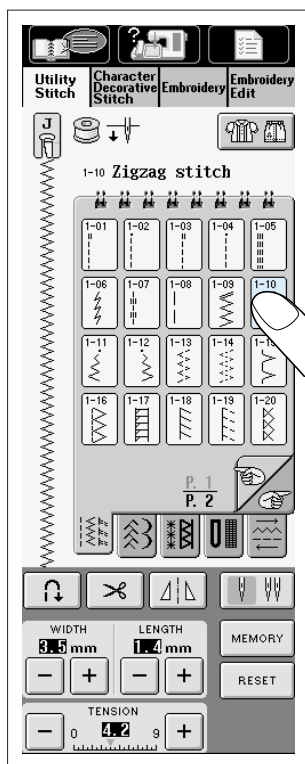

Press a key with your finger to select the stitch pattern, or to select a machine function, or operation indicated on the key.

CAUTION

Only touch the screen with your finger or the included touch pen. Do not use a sharp pencil, screwdriver, or other hard or sharp object. It is not necessary to press hard on the screen. Pressing too hard or using a sharp object may damage the screen.

Adjusting Screen Brightness

CAUTION

- All or part of the screen may sometimes become darker or lighter because of changes in the air temperature or other changes in the environment around the screen. This is normal and is not a sign of malfunction. Adjust the screen if it is difficult to read.
- The screen may be dark immediately after turning on the power. This is a function of the LCD back light screen, and it is not a sign of malfunction. The screen will return to its normal level of brightness after approximately 10 minutes.
- If you are not directly in front of the machine when you view the LCD, the colors may appear to change or the screen may be difficult to see. This is a characteristic of the LCD, and not a sign of damage or malfunction. For best results operate the screen while sitting in front of the machine.

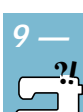

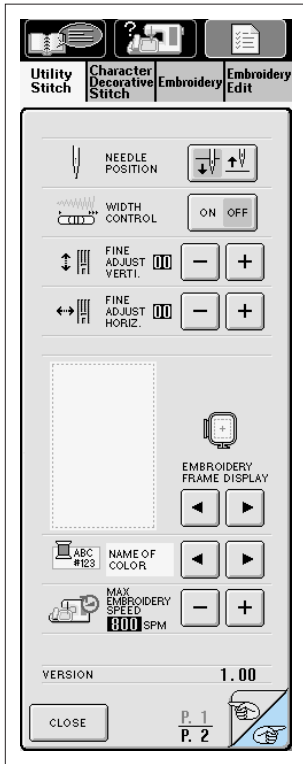



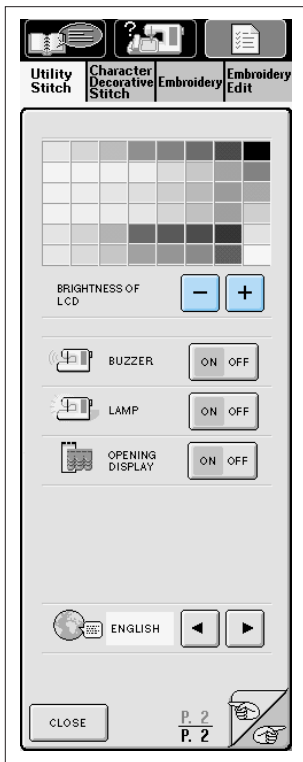

1. Press  to open the screen at left.

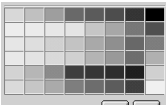
2. Press  to go to the next screen.



3. On the  display, use  and  to adjust the screen brightness.

*  makes the screen darker

*  makes the screen lighter

4. Once you have adjusted the screen brightness, press .

Choosing the Display Language

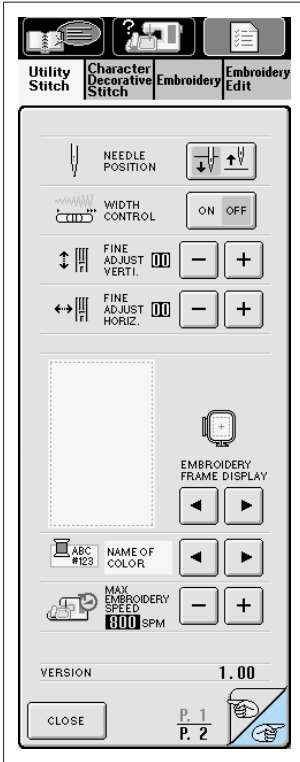

1. Press  to open the screen at left.

2. Press  to go to the next screen.

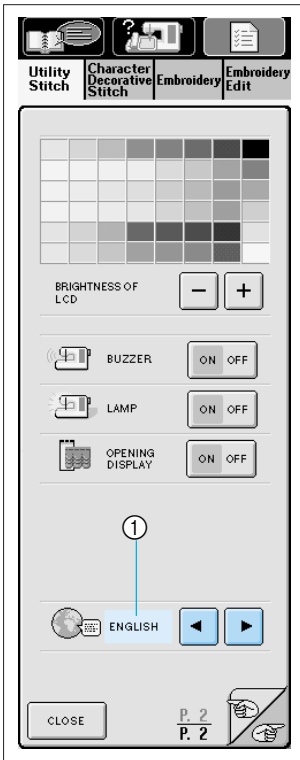

3. When you see this  display, press the arrow keys to choose the display language.

- * Choose from the following languages: ENGLISH
GERMAN
FRENCH
ITALIAN
DUTCH
SPANISH

① Shows the selected display language

4. When the desired language is displayed, press  .



Using the Machine Settings Key



Press to change the default machine settings (needle stop position, embroidery speed, opening display, etc.)

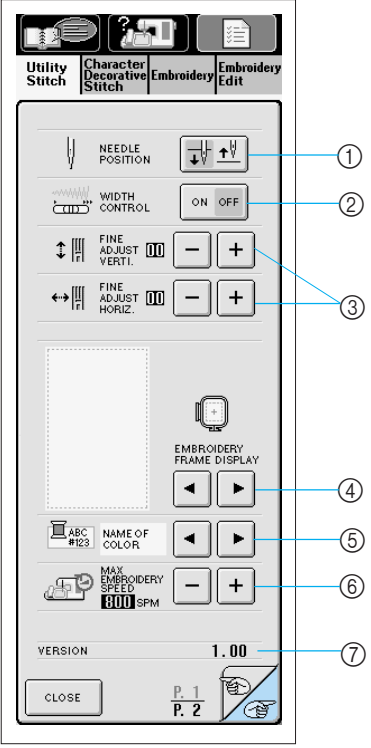

- ① Select the needle stop position (the needle position when the machine is not operating) to be up or down.
- ② Select whether to use the sewing speed controller to determine the zigzag width (see page 3-34).
- ③ Make adjustments to character or decorative stitch patterns (see page 4-12).
- ④ Select from among 8 displays when using the Embroidery functions (see page 5-43).
- ⑤ Change the thread color display on the embroidery screen; display the thread number, color name or each time to embroider (see page 5-42).
- ⑥ Adjust the maximum embroidery speed setting (see page 5-41).
- ⑦ Program version display

Note _____
Version 1.0, this is the installed software version for your machine. Check with your local authorized Brother dealer or at www.brother.com for notification of an available updates.

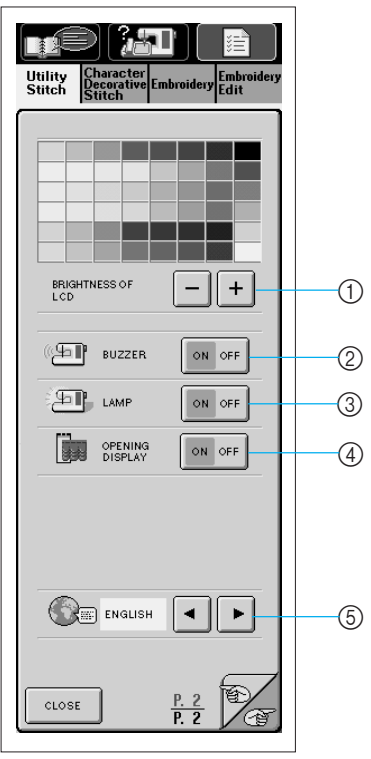



- Press to go to the next screen.
- ① Change the brightness of the LCD (see page 1-16).
 - ② Turn the buzzer ON or OFF.
 - ③ Turn the lamp ON or OFF.
 - ④ Turn the opening screen display ON or OFF.
 - ⑤ Change the display language (see page 1-18).

Using the Machine Operations Key

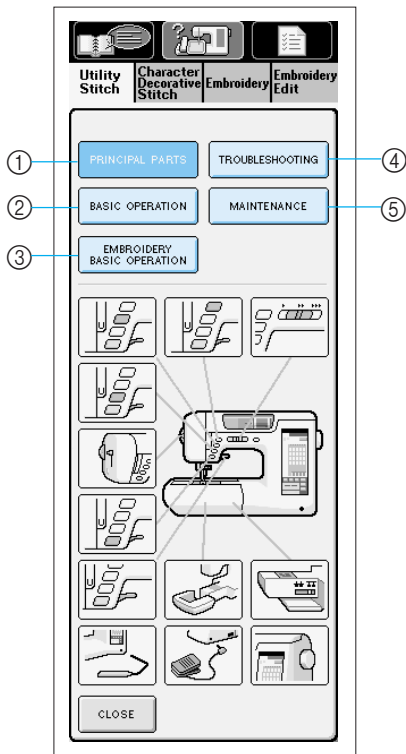

Press  to open the screen shown below. Five categories are displayed at the top of the screen. Press a key to see more information about that category.





- ① **PRINCIPAL PARTS** displays information about the main parts of the machine and their functions. This is the first screen displayed when you press .
- ② **BASIC OPERATION** displays information about threading the machine, changing presser feet, etc.
- ③ **EMBROIDERY BASIC OPERATION** displays information about attaching the embroidery unit, feeding fabric, etc.
- ④ **TROUBLESHOOTING** displays information about dealing with minor difficulties.
- ⑤ **MAINTENANCE** displays information about changing the lamp, cleaning the machine, etc.

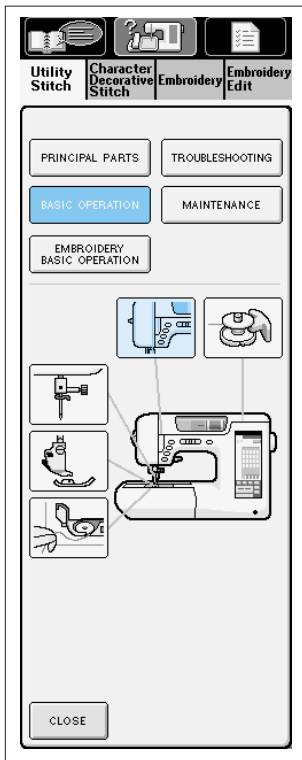



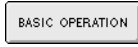



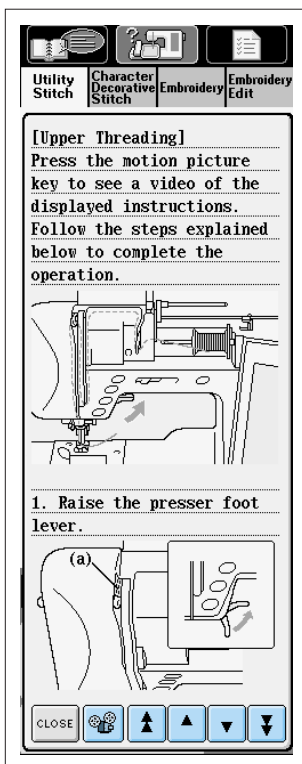

Example: Displaying information about upper threading

1. Press .
2. Press . The lower half of the screen will change.
3. Press  (upper threading).



4. This screen shows instructions for threading the machine. Use the arrow keys to scroll downward for more information.
 -   = to scroll slowly
 -   = to scroll quickly
 If you select bobbin winding, setting the bobbin, or upper threading,  is displayed. Press  to see a video of the displayed instructions.
5. Press  to go back to the original screen.



■ Contents of Other Categories

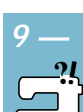
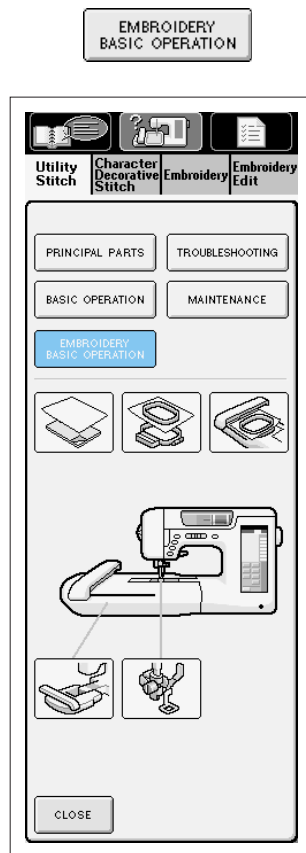
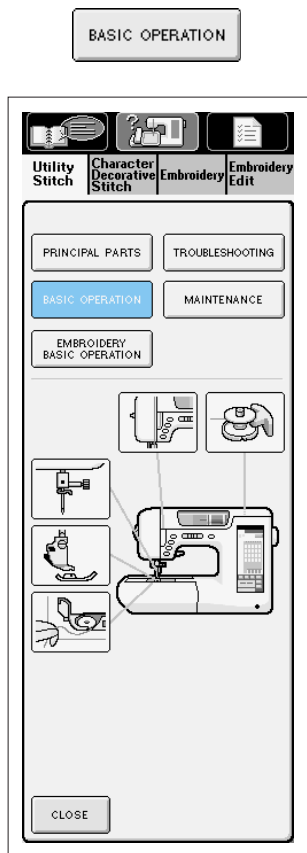
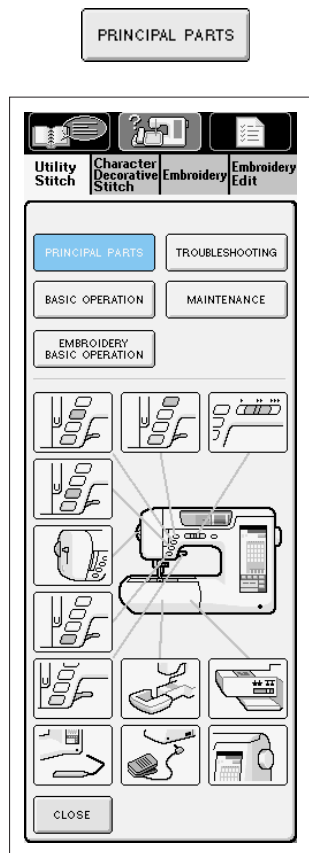

TROUBLESHOOTING

MAINTENANCE

Utility Stitch	Character Decorative Stitch	Embroidery	Embroidery Edit
PRINCIPAL PARTS		TROUBLESHOOTING	
BASIC OPERATION		MAINTENANCE	
EMBROIDERY BASIC OPERATION			
UPPER THREAD BREAKS		BOBBIN THREAD BREAKS	
SKIPPED STITCHES		FABRIC PUCKERS	
HIGH-PITCHED SOUND WHILE SEWING		CAN NOT THREAD THE NEEDLE	
THREAD TENSION IS INCORRECT		CHARACTER PATTERN DOES NOT SEW OUT CORRECTLY	
EMBROIDERY PATTERN DOES NOT SEW OUT CORRECTLY		NEEDLE BREAKS	
FABRIC DOES NOT FEED THROUGH THE MACHINE		THE MACHINE DOES NOT OPERATE	
THE EMBROIDERY UNIT DOES NOT OPERATE		THE LCD DISPLAY IS DIFFICULT TO SEE	
CLOSE			

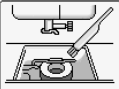
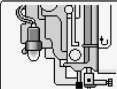
Utility Stitch	Character Decorative Stitch	Embroidery	Embroidery Edit
PRINCIPAL PARTS		TROUBLESHOOTING	
BASIC OPERATION		MAINTENANCE	
EMBROIDERY BASIC OPERATION			
			
CLOSE			



Using the Pattern Explanation Key

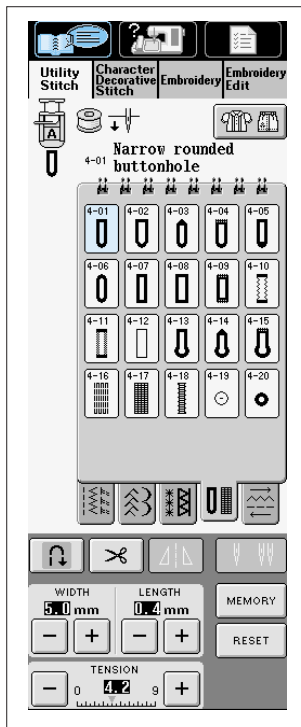

If you want to know more about the uses for a stitch pattern, select the pattern and press  to see an explanation of the stitch selection.



Example: Displaying information about 

1. Press . (If the currently displayed stitch selection screen does not include  use the screen selection tabs to go to the correct screen).

2. Press .

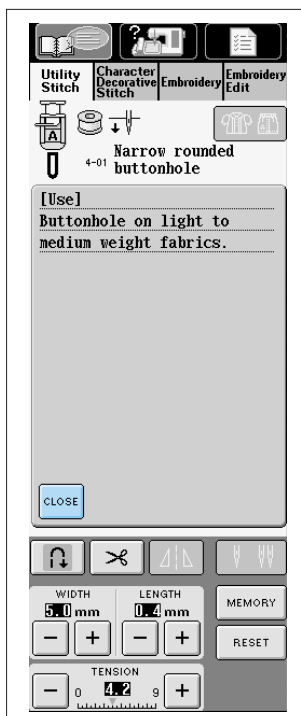

3. The screen shows information about .

4. Press  to return to the original screen.

1 —



2 —



3 —



4 —



5 —



6 —



7 —



8 —



9 —



Bobbin Winding/Lower Threading

Press → → → in that order to display a video example of bobbin winding on the LCD (see page 1-21). Follow the steps explained below to complete the operation.

▲ CAUTION
Use only bobbins recommended by the manufacturer of this machine (see page 1-8). Using other bobbins may result in damage or injury.

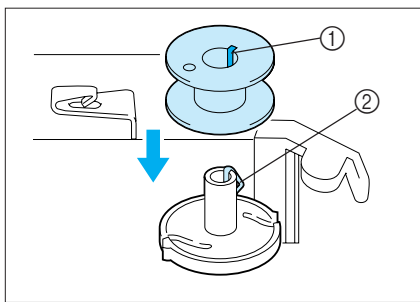
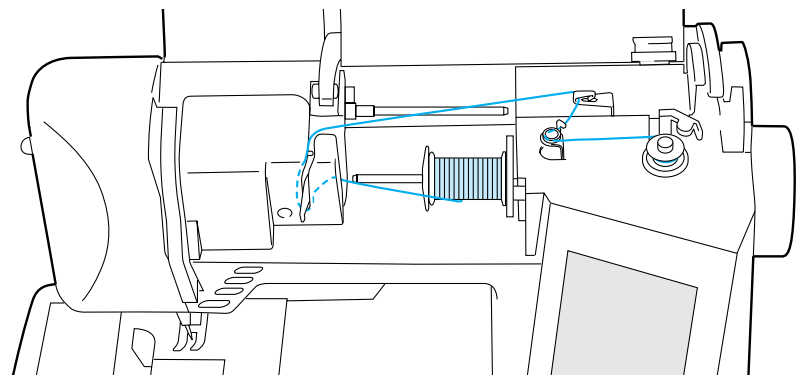

1. Turn on the main power switch.
2. Align the groove in the bobbin with the spring on the bobbin winder shaft, and set the bobbin on the shaft.
 - ① Groove of the bobbin
 - ② Spring on the shaft

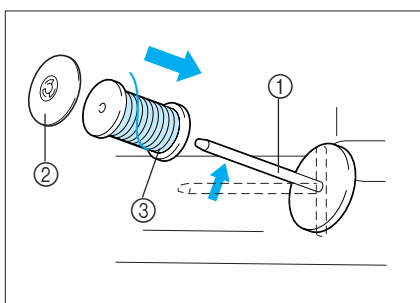

3. Pivot the spool pin so that it angles toward the front of the machine. Set the thread spool on the spool pin so that the thread unrolls from the front of the spool.
4. Push the spool cap on the spool pin as far as possible, then return the spool pin to its original position.
 - ① Spool pin
 - ② Spool cap
 - ③ Thread spool

▲ CAUTION

- If the thread spool and/or spool cap are set incorrectly, the thread may tangle on the spool pin and cause the needle to break.
- Use the spool cap (large, medium, or small) that is closest in size to the thread spool. If a spool cap smaller than the thread spool is used, the thread may become caught in the slit on the edge the spool and cause the needle to break.

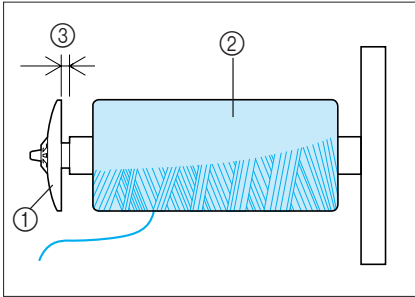
**Note**

When sewing with fine, cross-wound thread (see the illustration at left), use the small spool cap, and leave a small space between the cap and the thread spool (see the illustration at left).

- ① Spool cap (small)
- ② Thread spool (cross-wound thread)
- ③ Space

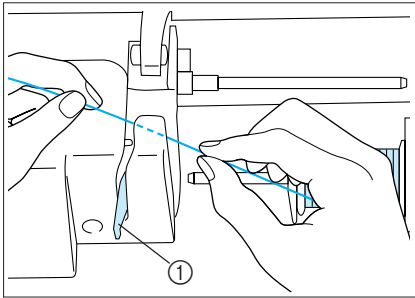

5. Hold the thread from the spool in both hands, and pass the thread behind the thread guide cover on top of the machine.

Use both hands to set the thread around the thread guide plate.

- ① Thread guide plate

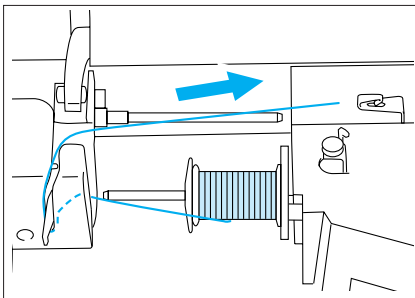
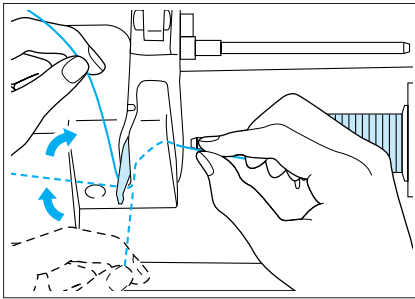

6. Pull the thread out as indicated on drawing.



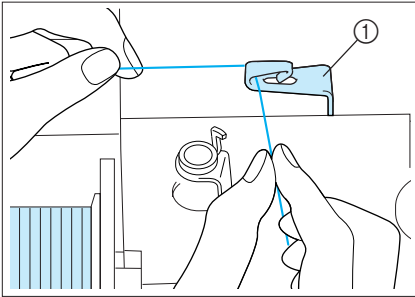

7. Use both hands to set the thread around projection in the thread guides.

- ① Projection in the thread guides

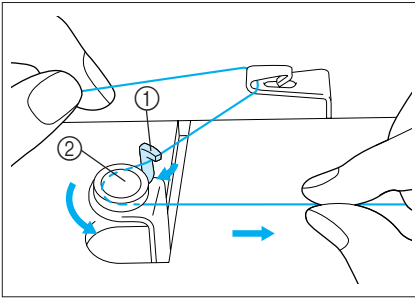

8. Pass the thread around the thread guide shaft and the pretension disk as indicated on drawing. Make sure that thread is correctly inserted inside the pretension disk.

- ① Thread guide shaft
② Pretension disk

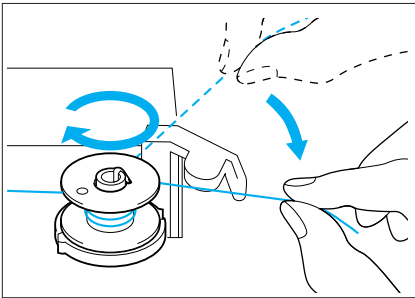

9. Wind the thread clockwise around the bobbin 4-5 times (as shown in the illustration).

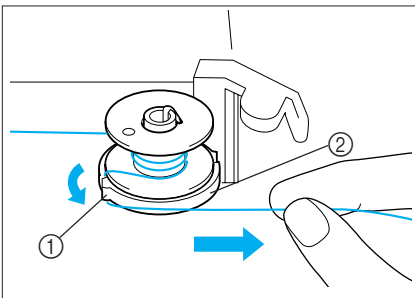

10. Pass the end of the thread through the guide slit in the bobbin winder seat, and pull the thread to the right. The cutter will cut the thread.

- ① Guide slit
② Bobbin winder seat

▲ CAUTION

Be sure to follow the process described. If the thread is not cut with the cutter, and the bobbin is wound, when the thread runs low it may tangle around the bobbin and cause the needle to break.



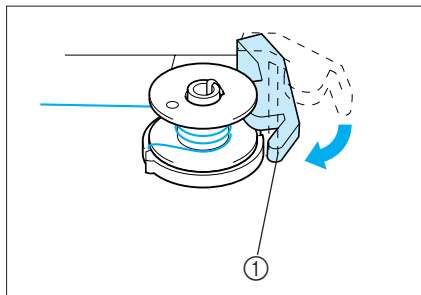

11. Set the bobbin holder to the left, until it clicks into place.

① Bobbin holder

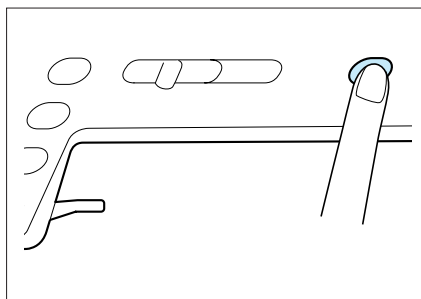

12. Press the "Bobbin Winder" button to start winding the bobbin.

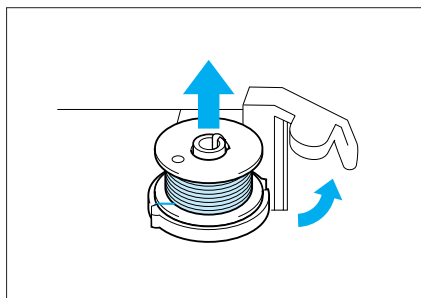

13. The bobbin will stop rotating automatically when it is done winding, and the bobbin holder will return to the original position.

14. Remove the bobbin.

CAUTION

When removing the bobbin, do not pull on the bobbin winder seat. Doing so could loosen or remove the bobbin winder seat, resulting in damage to the machine.

▲ CAUTION

Setting the bobbin improperly may cause the thread tension to loosen, breaking the needle and resulting in injury.

- ① Wound evenly
- ② Wound poorly

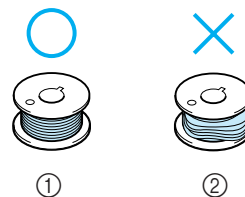



■ Winding the Bobbin During Sewing

With this machine, you can wind the bobbin during sewing. It will be convenient to wind the bobbin embroidery thread while sewing embroidery. The threading process is different from the earlier section, so read and follow the instructions carefully.

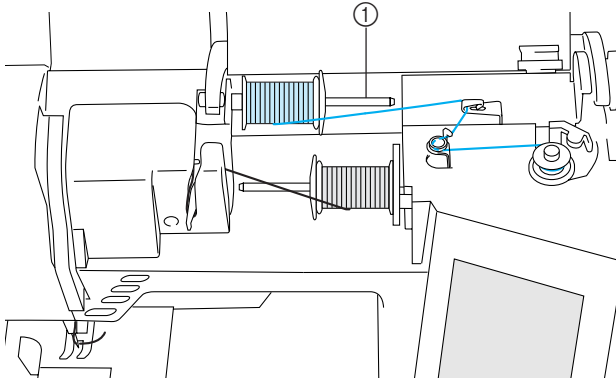

① Supplemental spool pin

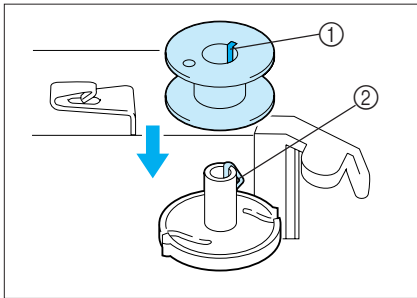

1. Align the groove in the bobbin with the spring on the bobbin winder shaft, and set the bobbin on the shaft.

- ① Groove of the bobbin
- ② Spring on the shaft

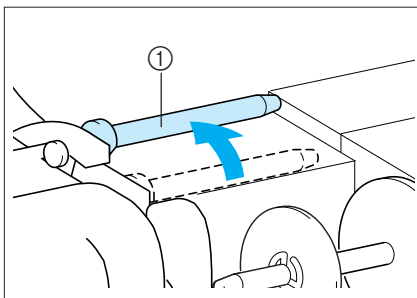

2. Pull up the supplemental spool pin and set it in the "up" position.

- ① Supplemental spool pin

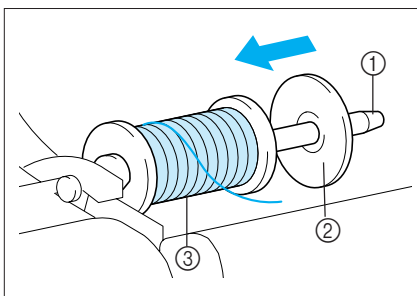

3. Place the spool of thread on the supplemental spool pin, so that thread unrolls from the back. Then push a spool cap onto the spool pin as far as possible to secure the thread spool.

- ① Spool pin
- ② Spool cap
- ③ Thread spool

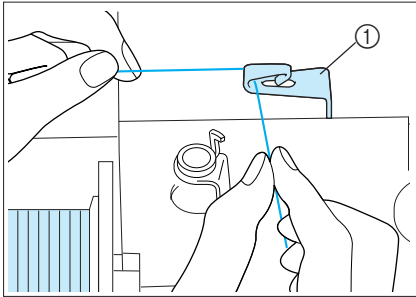

4. With your left hand, hold the thread near the thread spool. With your right hand, hold the end of the thread, and use both hands to set the thread around the thread guides.

① Projection in the thread guides

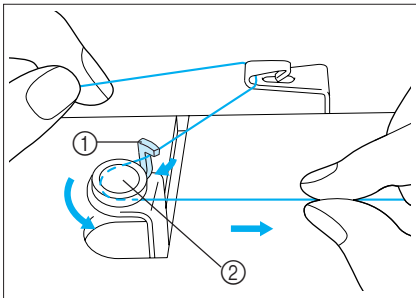

5. Pass the thread around the projection in the thread guides, then pass the thread under the pretension disk. Make sure to set the thread securely under the pretension disk.

① Thread guide shaft

② Pretension disk

6. Follow steps 9 - 14 from the previous section (see pages 1-27, 1-28).





Setting the Bobbin

Press → → in that order to display a video example of the operation on the LCD (see page 1-21). Follow the steps explained below to complete the operation.

▲ CAUTION
 Setting the bobbin improperly may cause the thread tension to loosen, breaking the needle and resulting in injury.

- ① Wound evenly
- ② Wound poorly

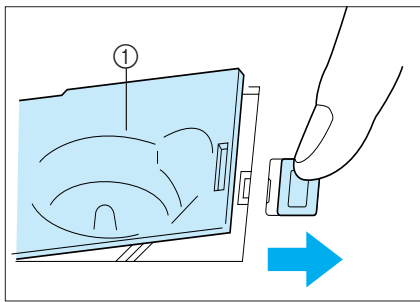

1. Raise the presser foot lever.
2. Slide the bobbin cover latch to the right, and remove the bobbin cover.
 - ① Bobbin cover

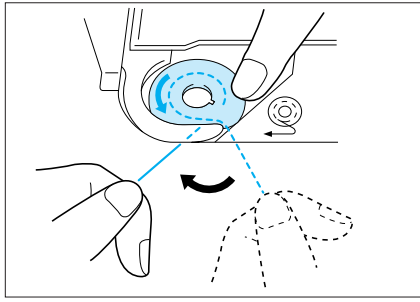

3. Put the bobbin in the shuttle, making sure the thread unrolls as shown.

▲ CAUTION
 Be sure the bobbin is set so the thread unrolls in the correct direction. If the thread unrolls in the wrong direction, it may cause the thread tension to be incorrect or the needle to break.

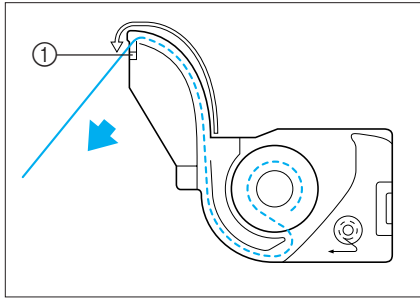

4. Guide the thread through the groove, then pull the thread toward you to cut off any excess.
 - ① Cutter

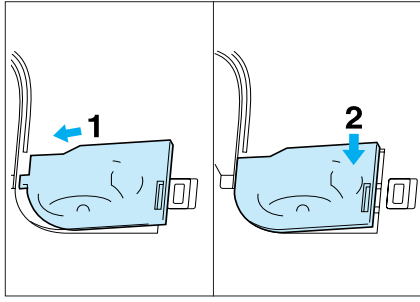

5. Replace the bobbin cover. Place the left tab in place (see arrow 1 at left), then press lightly on the right side (see arrow 2 at left) until the cover clicks into place.

Note _____
 You can begin sewing without pulling up the bobbin thread.
 When you need to pull up the bobbin thread (free motion embroidery) see the illustrated directions on page 1-38.

Upper Threading

Press  →  →  →  in that order to display a video example of the operation on the LCD (see page 1-21). Follow the steps explained below to complete the operation.

▲ CAUTION

Be sure to thread the machine properly. Improper threading can cause the thread to tangle and break the needle, leading to injury.

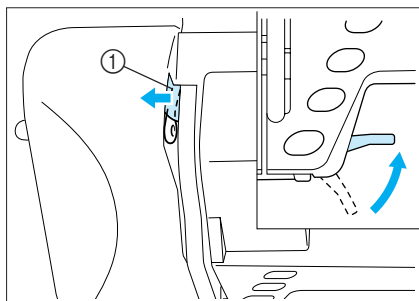
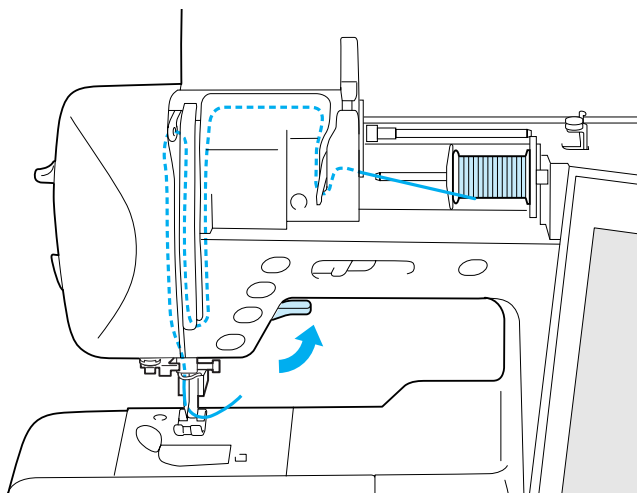

1. Raise the presser foot lever.

CAUTION

The machine has an upper threading shutter to insure proper threading. The upper threading shutter opens when the presser foot is raised. Upper threading can not take place if the presser foot is not raised.

- ① Upper threading shutter

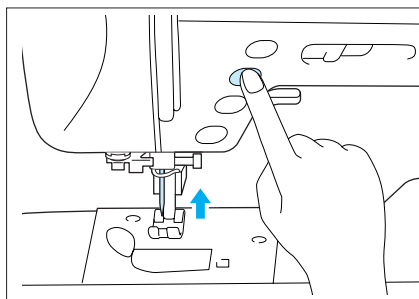

2. Press the "Needle Position" button to set the needle in the up position.

This step moves the thread take-up lever to a position in which it can be threaded. Be sure to do this step before continuing.



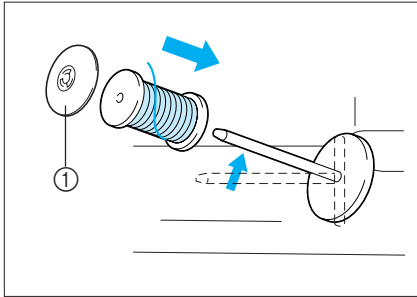

3. Pivot the spool pin so that it angles toward the front of the machine. Set the thread spool on the spool pin so that the thread unrolls from the front of the spool.
4. Push the spool cap onto the spool pin as far as possible, then return the spool pin to its original position.
 - ① Spool cap

▲ CAUTION

- If the thread spool and/or spool cap are set incorrectly, the thread may tangle on the spool pin and cause the needle to break.
- Use the spool cap (large, medium, or small) that is closest in size to the thread spool. If a spool cap smaller than the thread spool is used, the thread may become caught in the slit on the end of the spool and cause the needle to break.

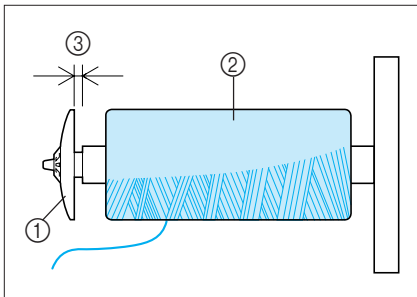

Note

When sewing with fine, cross-wound thread (see the illustration), use the small spool cap, and leave a small space between the cap and the thread spool (see the illustration at left).

- ① Spool cap (small)
- ② Thread spool (cross-wound thread)
- ③ Space

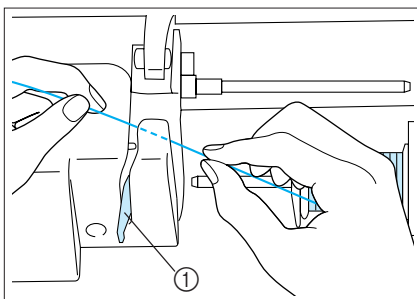

5. Hold the thread from the spool in both hands, and pass the thread around the plate in the thread guides. Use both hands to set the thread around the thread guide plate.

- ① Thread guide plate

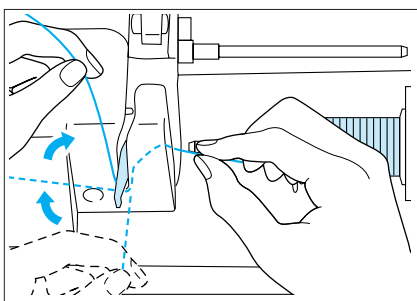

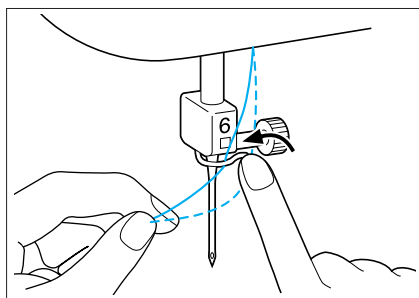
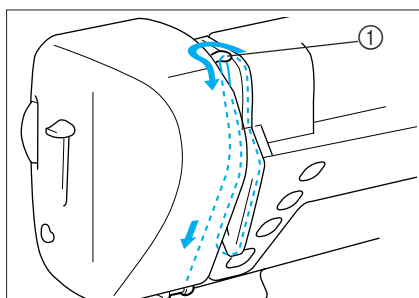
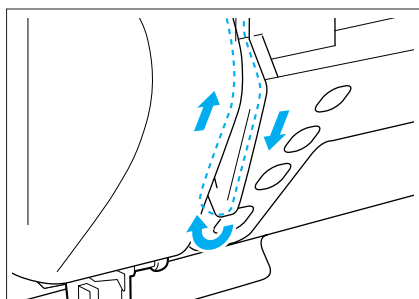
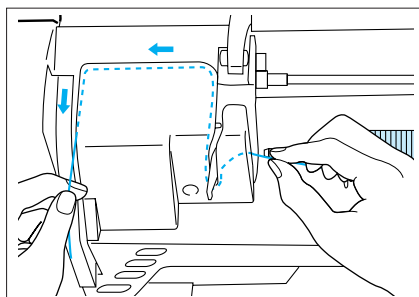

6. Pass the thread through the groove according to the threading sequence (numbers) indicated on the machine.

7. To thread the take-up lever, pass the thread from the back right side to the front left side.

① Threading the take-up lever

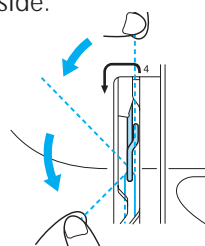

8. Set the thread behind the needle clamp thread guide on the needle bar. To set the thread easily, hold the end of the thread with your left hand, and use your right hand to guide the thread behind the needle clamp thread guide.

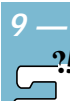

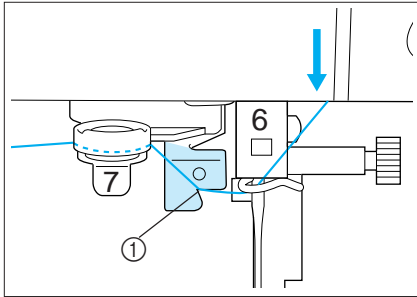

9. Set the thread securely into the slit of the disk in the thread guide. Be sure that the thread catches the corner of the thread guide.

① Corner of the thread guide

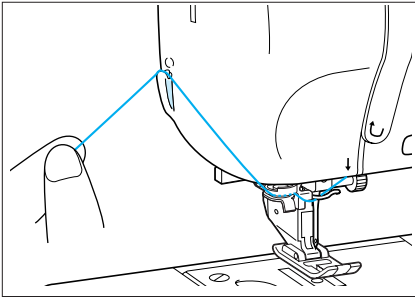

10. Use the thread cutter on the side of the machine to cut the thread.

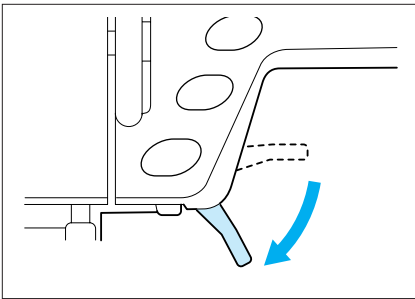

11. Lower the presser foot lever.

CAUTION

Be sure to lower the presser foot lever. Continuing without lowering the lever may cause damage to the machine.

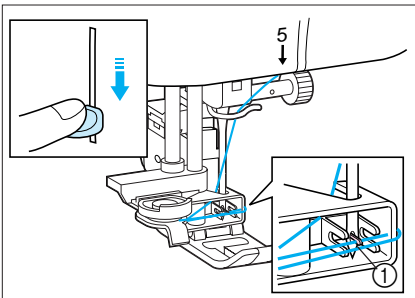

12. Push down the needle threader lever as far as possible. The hook will rotate and pass through the eye of the needle. Make sure that the hook does not catch the fabric or any other objects near the presser foot.

① Hook



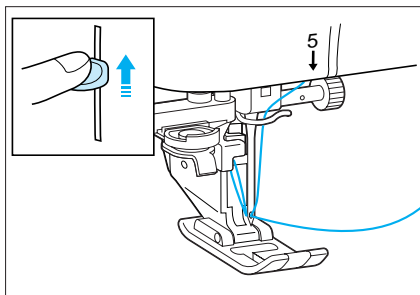

13. Slowly return the needle threader lever to its original position. Check that the hook has pulled the thread through the eye, then release the lever.

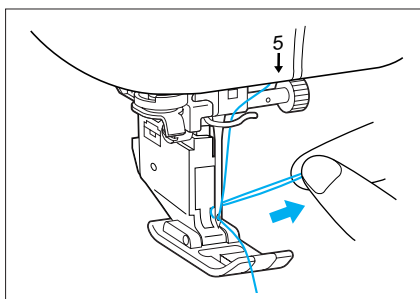

14. Pull the thread loop toward the back of the machine.

Note

Do not pull the thread too strongly, as you may bend the needle.

CAUTION

The needle threader lever can only be used with home sewing machine needles size 75/11-100/16. Check the table on page 1-45 for appropriate needle and thread combinations. Note that, if you are using transparent nylon mono-filament thread, only needles in the range of 90/14-100/16 can be used.

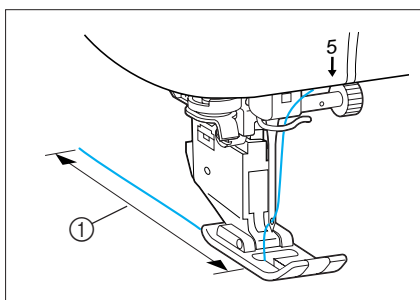

15. Pass the thread under the presser foot, and pull it about 100 mm (3 inch - 4 inch) toward the back of the machine.

① 100 mm (3 inch - 4 inch)

CAUTION

- If the threading is not successful, raise the presser foot lever and start again from step 8, setting the thread in the needle clamp thread guide.
- There are certain decorative threads that can not be threaded using the needle threader lever. When using these threads, set the thread behind the needle clamp thread guide (step 8), then thread the eye of the needle manually. Make sure the main power switch is OFF when threading the needle manually.

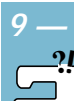

■ Using the Spool Net

If using decorative thread which tends to wind quickly off the thread spool, attach a spool net to the spool before using. This will control thread delivery.

* Cut the spool net to match the size of the spool.

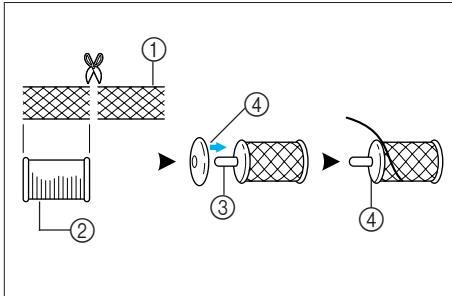

- ① Spool net
- ② Thread spool
- ③ Spool pin
- ④ Spool cap



Pulling Up the Bobbin Thread

There may be some sewing applications when you want to pull up the bobbin thread, for example, when making gathers, darts, free motion quilting or embroidery.

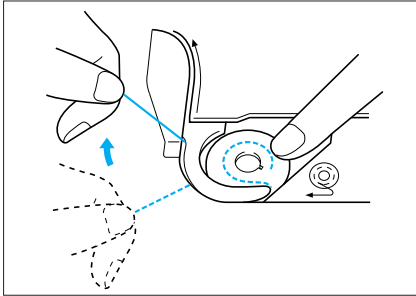

1. Guide the bobbin thread through the groove, following the arrow in the illustration. Do not cut the thread.
 - * Do not replace the bobbin cover.

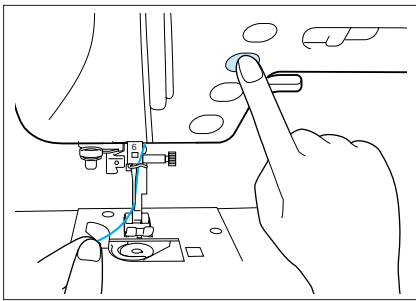

2. While holding the upper thread, press the needle position button to raise the needle.

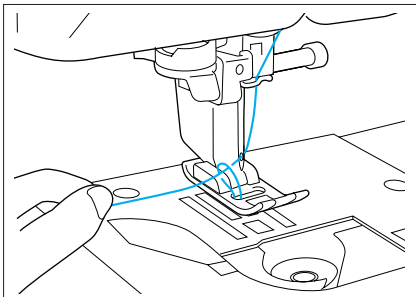

3. Gently pull the upper thread, and a loop of the bobbin thread will come out of the hole in the needle plate.

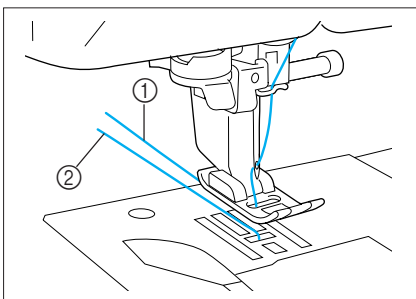

4. Pull up the bobbin thread, then pass it under the presser foot and pull it about 100 mm (3-4 inch) toward the back of the machine, matching the upper thread.
5. Replace the bobbin cover.
 - ① Upper thread
 - ② Bobbin thread





Changing the Presser Foot

▲ CAUTION

- Always turn off the power before changing the presser foot. If the power is on and the “Start/Stop” button or another button is pressed, the machine will start and may cause injury.
- Always use the correct presser foot for the selected stitch pattern. If the wrong presser foot is used, the needle may strike the presser foot and bend or break, and may cause injury.
- Only use presser feet for this machine. Using other presser feet may lead to accident or injury.

■ Removing the Presser Foot

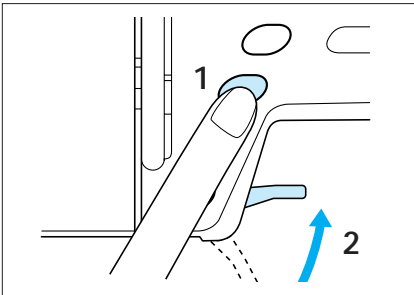

1. Press the “Needle Position” button to raise the needle, and then turn off the sewing machine.
2. Raise the presser foot lever.

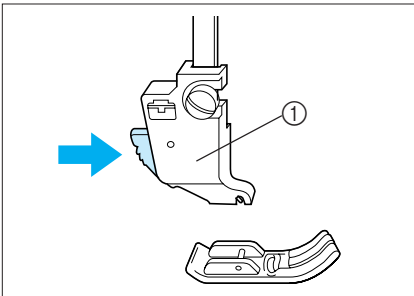

3. Press the black button at the back of the presser foot holder. The presser foot comes off.
 - ① Presser foot holder

■ Attaching the Presser Foot

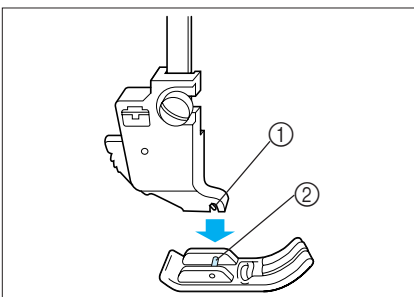

4. Place the new presser foot under the holder, aligning the foot pin with the notch in the holder. Lower the presser foot lever so that the presser foot pin snaps into the notch in the holder.

- ① Notch
- ② Pin



■ Attaching the Walking Foot

The walking foot holds the fabric between the presser foot and the upper and lower feed dogs to feed the fabric, this enables you to have better fabric control when sewing difficult fabrics (such as vinyl cloth, leather, or synthetic leather) or fabrics that slip easily (such as quilting or velvet).

- * The walking foot can only be used with straight or zigzag stitch patterns. Reverse stitches can not be sewn with the walking foot. Only select straight or zigzag stitch patterns with reinforcement stitches.

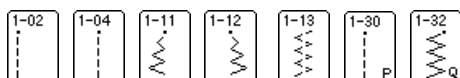

- * To use the walking foot, you need the low shank adapter and the screw (large) for the walking foot.

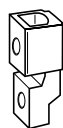

Adapter

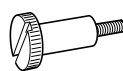

Screw(large)

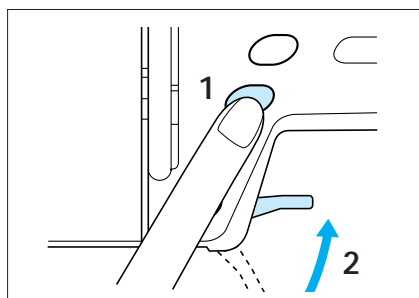

1. Press the "Needle Position" button to set the needle in the up position, and then turn off the main power switch.

2. Raise the presser foot lever.

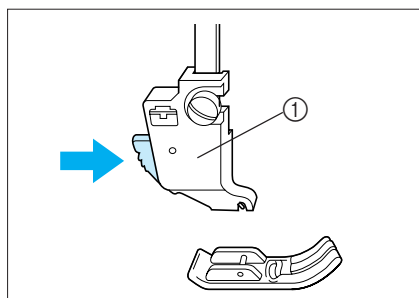

3. Push the black button on the presser foot holder and remove the presser foot.

① Presser foot holder

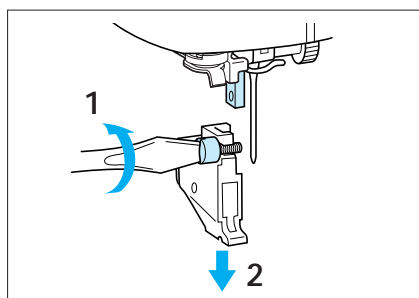

4. Loosen the screw of the presser foot holder to remove the presser foot holder.

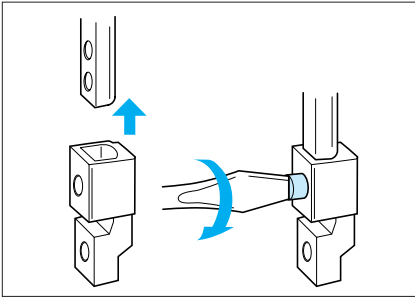

- Set the low shank adapter for the walking foot that came with your machine on the presser foot shaft, and push it up as far as possible. Tighten the screw securely with the screwdriver.

▲ CAUTION

Use the screwdriver to tighten the screw securely. If the screw is loose, the needle may strike the presser foot and cause injury.

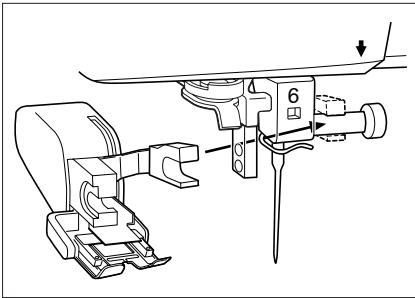

- Set the operation lever of the walking foot so that the fork surrounds the needle clamp, and set the walking foot on the presser foot shaft.

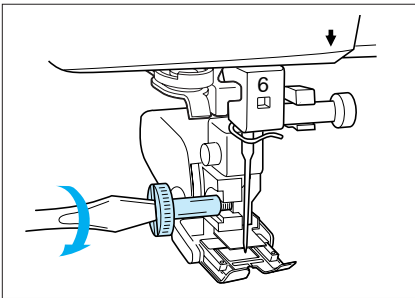

- Lower the presser foot lever, insert the screw (large) for the walking foot, and tighten the screw securely with the screwdriver.

▲ CAUTION

- Use the screwdriver to tighten the screw securely. If the screw is loose, the needle may strike the presser foot and cause injury.
- Be sure to turn the balance wheel toward the front of the machine to check that the needle does not strike the presser foot. If the needle strikes the presser foot, injury may result.

CAUTION

When sewing with the walking foot, sew at medium to low speeds.



■ Reattaching the Presser Foot Holder

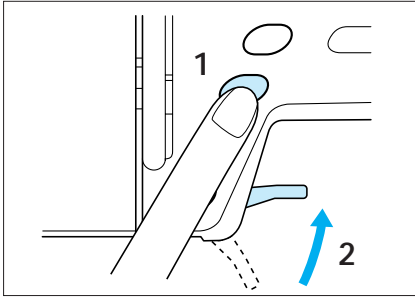

1. Push the "Needle Position" button to raise the needle, then turn the main power switch to OFF.
2. Raise the presser foot lever.

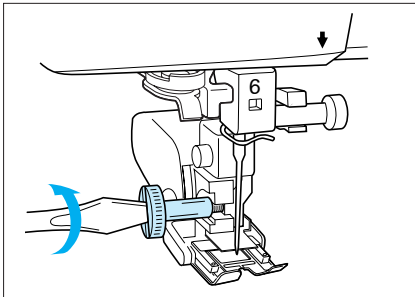

3. Loosen the screw with the screwdriver, and remove the walking foot.

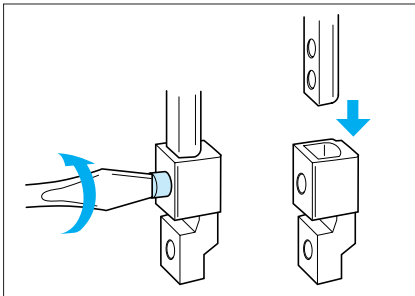

4. Remove the low shank adapter.



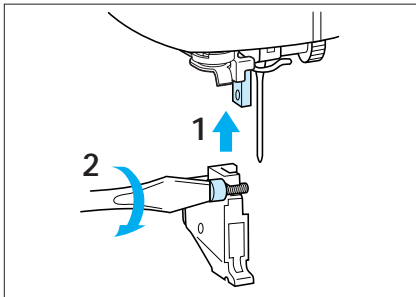

5. With the presser foot lever raised, tighten the screw lightly to attach the presser foot holder.
6. Place the presser foot "J" under the holder. Lower the presser foot lever and use the screwdriver to tighten the screw firmly.

Note

If the presser foot holder is not installed correctly, the thread tension may loosen due to improper presser foot holder height.

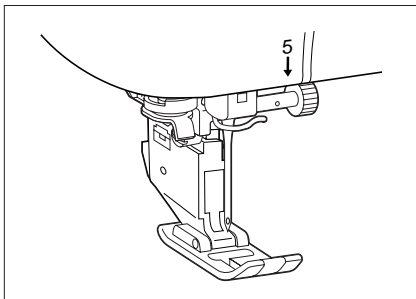

▲ CAUTION

- Be careful not to touch the needle during this time, otherwise injury may result.
- Use the screwdriver to tighten the presser foot holder screw securely. If the screw is loose, the needle may strike the presser foot and cause injury.

Changing the Needle

▲ CAUTION

- Turn the main power switch to OFF before changing the needle. If the main power is left on and the Start/Stop button or another operation button is pressed accidentally, the machine will start and injury may result.
- Use only sewing machine needles for home use. Other needles may bend or break and cause injury.
- Never sew with a bent needle. A bent needle will easily break and cause injury.

To Check the Needle Correctly:

To check the needle, place the flat side of the needle on a flat surface. Check the needle from the top and the sides. Throw away any bent needles.

- ① Parallel space
- ② Level surface (bobbin cover, glass, etc.)

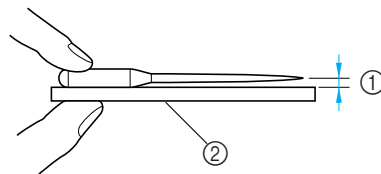

* Place a level surface under the needle



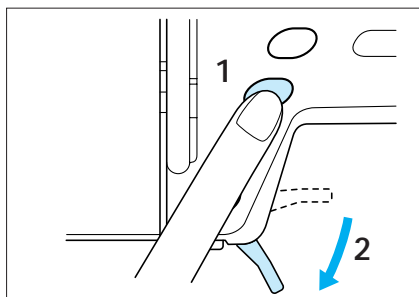

1. Press the "Needle Position" button to raise the needle, then turn the main power switch to OFF.
2. Lower the presser foot lever.

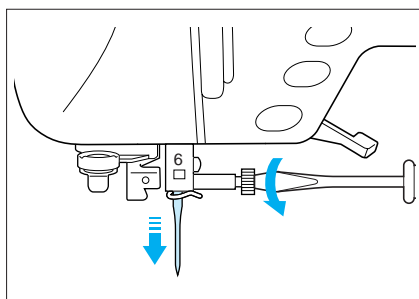

3. Use the screwdriver to turn the screw toward the front of the machine and loosen the screw, then remove the needle.

CAUTION

Do not apply pressure to the needle clamp screw. Doing so may damage the needle or machine.

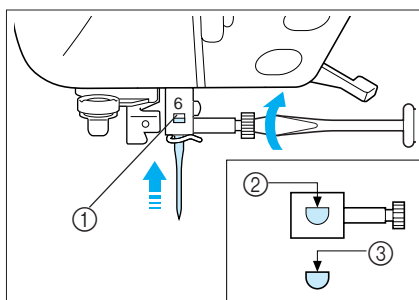
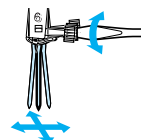

4. With the flat side of the needle facing the back, insert the new needle all the way to the top of the needle stopper (viewing window) in the needle clamp. Use a screwdriver to securely tighten the needle clamp screw.

- ① Needle stopper
- ② Hole for setting needle
- ③ Flat side of needle

▲ CAUTION

Be sure to push in the needle until it touches the stopper, and securely tighten the needle clamp screw with a screwdriver. If the needle is not completely inserted or the needle clamp screw is loose, the needle may break or the machine may be damaged.

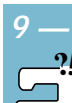



■ About the Needle

The sewing machine needle is probably the most important part of the sewing machine. Choosing the proper needle for your sewing project will result in a beautiful finish and fewer problems. Below are some things to keep in mind about needles.

- The smaller the needle number, the smaller the needle. As the numbers increase, the needles get thicker.
- Use fine needles with lightweight fabrics, and thicker needles with heavyweight fabrics.
- To avoid skipped stitches, use ball point needle (golden colored) 90/14 with stretch fabrics.
- To avoid skipped stitches, use ball point needle (golden colored) 90/14 when sewing character or decorative stitches without the embroidery unit.
- Use needle 75/11 for embroidery. Ball point needles (golden colored) 90/14 are not recommended for embroidery, as they may bend or break, causing injury.
- It is recommended that a 90/14 needle should be used when embroidering on heavyweight fabrics or stabilizing products (for example, denim, puffy foam, etc.). 75/11 needle may bend or break, which could result in injury.
- A home sewing machine needle 75/11 is inserted in the sewing machine.

■ Fabric/Thread/Needle Combinations

Fabric		Thread		Size of needle
		Type	Size	
Medium weight fabric	Broadcloth	Cotton	60 - 80	75/11 - 90/14
	Taffeta	Synthetic mercerized	60 - 80	
	Flannel, Gabardine	Silk or silk finished	50 - 80	
Lightweight fabric	Lawn, Batiste	Cotton	60 - 80	65/9 - 75/11
	Georgette	Synthetic mercerized	60 - 80	
	Challis, Satin	Silk	50 - 80	
Heavyweight fabric	Denim	Cotton	30 - 50	90/14 - 100/16
	Corduroy	Synthetic mercerized	50	
	Tweed	Silk	50	
Stretch fabric	Jersey	Thread for knits	50 - 60	Ball point needle (golden colored) 75/11 - 90/14
	Tricot			
For top stitching	Synthetic mercerized		30	90/14 - 100/16
	Silk		30	

Note

- For transparent nylon thread, always use needle 90/14 - 100/16.
- The same thread is usually used for the bobbin thread and upper threading.

▲ CAUTION

Be sure to follow the needle, thread, and fabric combinations listed in the table. Using an improper combination, especially a heavyweight fabric (i.e., denim) with a small needle (i.e., 65/9 - 75/11), may cause the needle to bend or break, and lead to injury. Also, the seam may be uneven, the fabric may pucker, or the machine may skip stitches.

1 —



2 —



3 —



4 —



5 —



6 —



7 —



8 —



9 —



Chapter 2 Getting Ready to Sew

TRIAL SEWING

Basic Sewing

▲ CAUTION

- To avoid injury, pay special attention to the needle while the machine is in operation. Keep your hands away from moving parts while the machine is in operation.
- Do not stretch or pull the fabric during sewing. Doing so may lead to injury.
- Do not use bent or broken needles. Doing so may lead to injury.
- Take care that the needle does not strike basting pins or other objects during sewing. Otherwise, the needle may break and cause injury.
- If stitches become bunched, lengthen the stitch length setting before continuing sewing. Otherwise, the needle may break and cause injury.

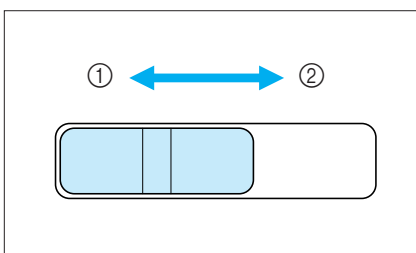
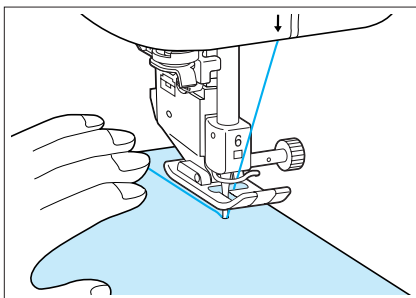
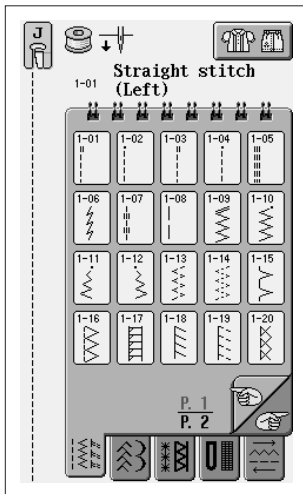

1. Turn on the main power switch, and push the "Needle Position" button to raise the needle.
2. Press a stitch selection key to select a stitch.
3. Install the correct presser foot. The symbol of the correct presser foot will be displayed in the upper left corner of the LCD display.
4. Set the fabric under the presser foot. Hold the fabric and thread ends in your left hand, and turn the balance wheel to set the needle in the sewing start position.

▲ CAUTION

Always use the correct presser foot. If the wrong presser foot is used, the needle may strike the presser foot and bend or break, resulting in injury.

5. Lower the presser foot.
 - * You do not have to pull up the bobbin thread.
6. Adjust the sewing speed with the speed control lever.
 - * You can use this lever to adjust sewing speed during sewing.
 - ① Slow
 - ② Fast



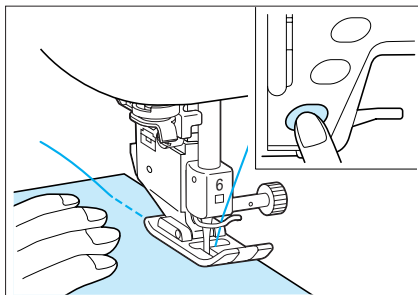

7. Press the "Start/Stop" button to begin sewing.

* Guide the fabric lightly by hand.

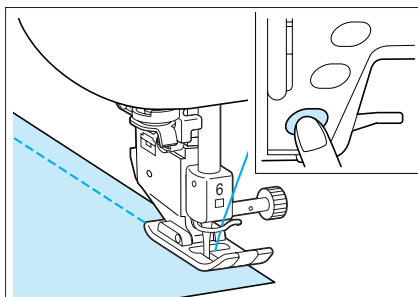

8. Press the "Start/Stop" button again to stop sewing.

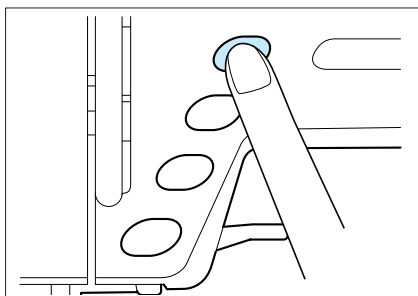

9. Press the "Thread Cutter" button to trim the threads.

* The needle will return to the up position automatically.

▲ CAUTION

Do not press the "Thread Cutter" button after the threads have been cut. Doing so could tangle the thread or break the needle and damage the machine.

CAUTION

- Do not press the "Thread Cutter" button when there is no fabric set in the machine or during machine operation. The thread may tangle, resulting in damage.
- When cutting thread thicker than #30, nylon thread, or other decorative threads, use the thread cutter on the side of the machine.

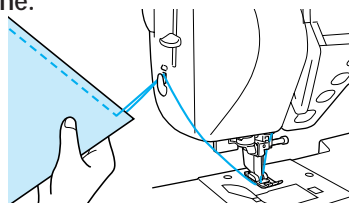

10. When the needle has stopped moving, raise the presser foot and remove the fabric.

Note

This machine has a display to warn you when the bobbin thread has run out. If the warning displays, re-thread the machine immediately.

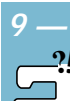

Sewing Reinforcement Stitches

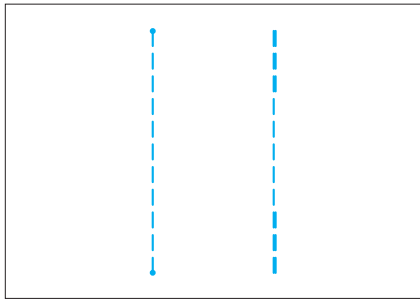

Reverse/reinforcement stitches are generally necessary at the beginning and end of sewing. You can use "Reverse/Reinforcement Stitch" button to sew reverse/reinforcement stitches manually (see page 1-3).

On the screen if the automatic reinforcement stitch key is selected, reverse stitches (or reinforcement stitches) will be sewn automatically at the start of sewing when pressing the "Start/Stop" button. Press the "Reverse/Reinforcement Stitch" button to sew reverse stitches (or reinforcement stitches) automatically at the finish of the sewing (see page 2-14).

Changing Sewing Direction

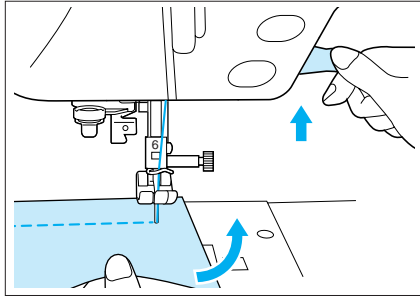

Stop the machine. Leave the needle in the fabric, and raise the presser foot. Using the needle as a pivot, turn the fabric so that you can sew in the new direction. Lower the presser foot lever and start sewing.

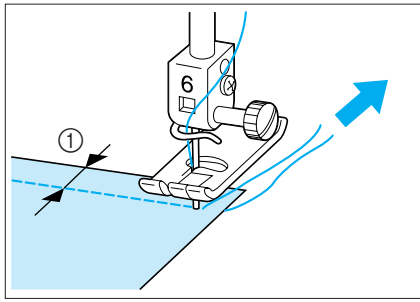

When edge stitching a short stitch length and close to the edge of the fabric, the presser foot may not cover enough fabric for proper feeding. Before you begin to sew, sew a basting thread at the corner point. When you change direction at the corner, start sewing as you pull the basting thread toward the back.

① 5 mm (3/16 inch)

Sewing Curves

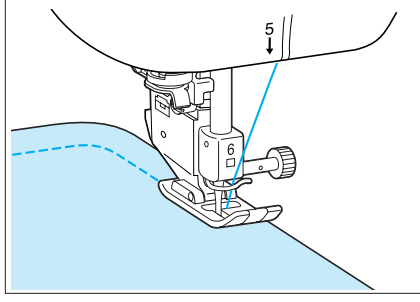

Sew slowly while keeping the seam parallel with the fabric edge as you guide the fabric around the curve.

Sewing Heavyweight Fabrics

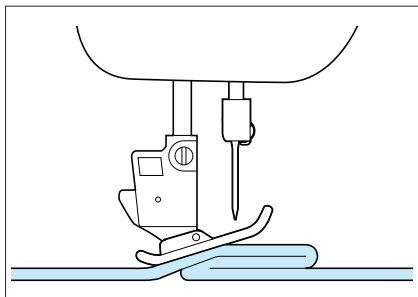

The sewing machine can sew fabrics up to 6 mm (1/4 inch) thick. If the thickness of a seam causes sewing to occur on an angle, help guide the fabric by hand and sew on the downward slope.

⚠ CAUTION

Do not forcefully push fabrics more than 6 mm (1/4 inch) thick through the sewing machine. This may cause the needle to break and cause injury.

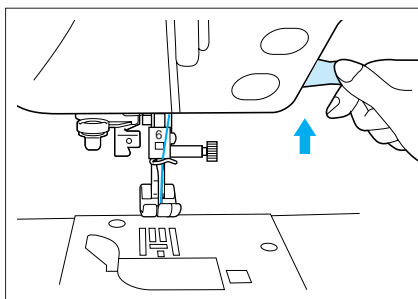

If the presser foot lever is in the up position, and you are sewing heavyweight or multiple layers of fabric which does not fit easily under the presser foot, raise the presser foot lever as high as possible by hand to bring the presser foot to its highest position. The fabric will now fit under the presser foot.

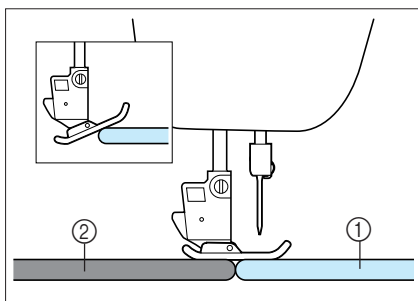

If the presser foot is not level and the fabric does not feed at the beginning of sewing (as shown at left), place a piece of fabric, paper or cardboard of the same thickness as the fabric being sewn under the back of the presser foot. The machine can then sew normally.

- ① Fabric
- ② Thick paper

Sewing Lightweight Fabrics

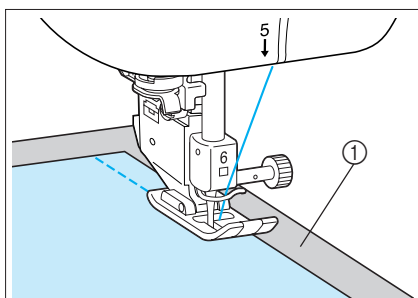

Place thin paper under thin fabrics to make sewing easier. Gently tear off the paper or the stabilizer for embroidery after sewing.

- ① Thin paper

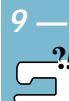

Using the Twin Needle Mode

The twin needle can only be used for patterns that show  after being selected. Before you select a stitch pattern, make sure the stitch can be sewn in the twin needle mode (see page 3-1 “Quick Reference Table”).

▲ CAUTION

- Use only twin needles made for this machine (part code X59296-001). Other needles could break, resulting in damage.
- Be sure to set the twin needle mode when using the twin needle. Using the twin needle while the machine is in single needle mode could cause the needle to break, resulting in damage.
- Do not sew with bent needles. The needle could break and cause injury.
- When using the twin needle, be sure to use presser foot “J” only. Refer to chart on page 3-1 through 3-8 for proper presser foot “J”.

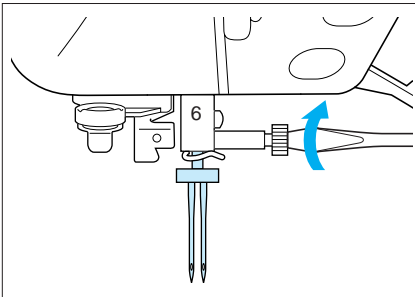

1. Turn the main power switch to OFF, and install the twin needle (see page 1-43 “Changing the Needle”).

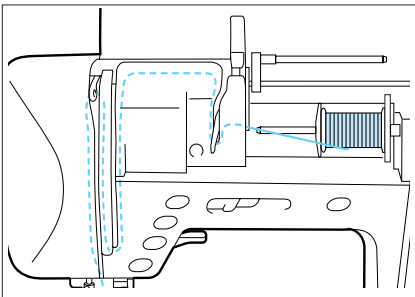

2. Do the upper threading. Follow the steps for threading a single needle for the first threading (see page 1-32 “Upper Threading”).

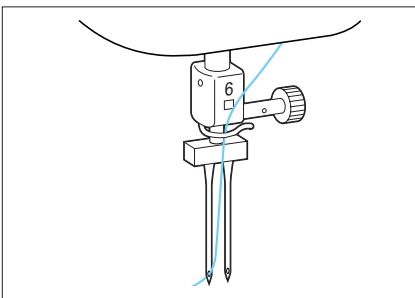

3. Pass the thread through the needle clamp thread guide on the needle bar, then thread the needle on the left side.

CAUTION

The needle threader lever can not be used. Thread the twin needle by hand, from front to back. Using the needle threader lever may result in damage to the machine.

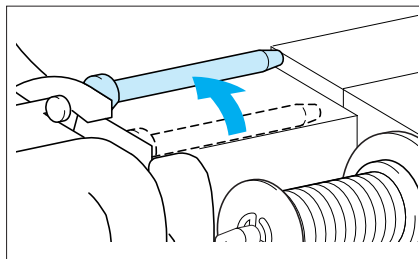

4. Pull up the supplemental spool pin and set it in the up position.

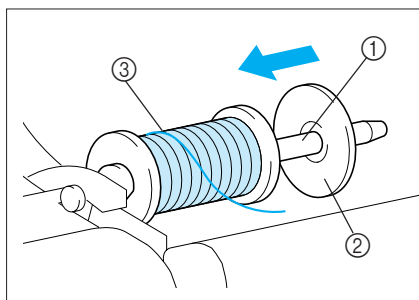

5. Place additional spool of thread on the supplemental spool pin, so that the thread unrolls from the back. Then insert a spool cap onto the spool pin all the way in, to secure the thread spool.

- ① Spool pin
- ② Spool cap
- ③ Additional spool of thread

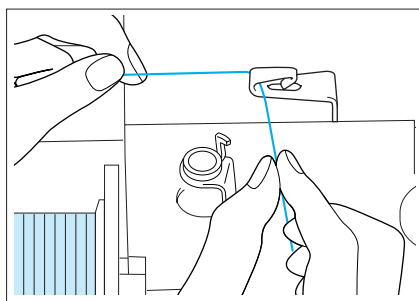

6. Hold the thread from the spool with both hands, and set the thread in the thread guide.

* Do not set the thread in the bobbin winding thread guide.

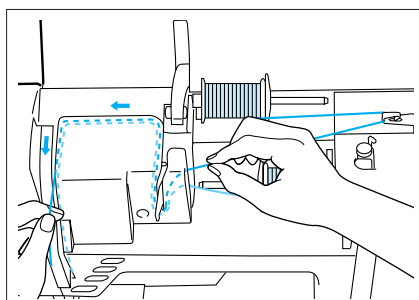

7. Set the thread around the thread guide plate, then pass the thread through the groove according to threading sequence (numbers) indicated on the machine.

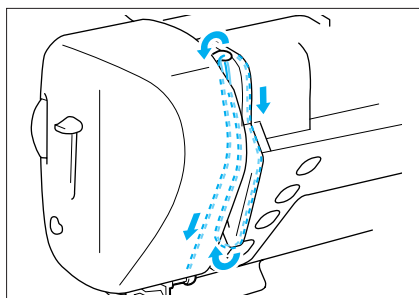

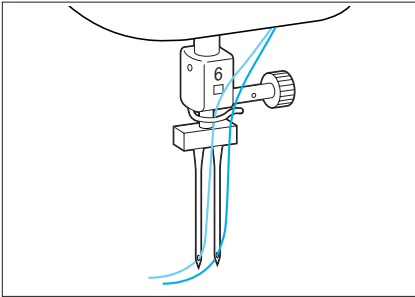

8. Do not set the thread in the needle clamp thread guide on the needle bar. Thread the needle on the right side.

CAUTION

The needle threader can not be used. Thread the twin needle by hand, from front to back. Using the needle threader may result in damage to the machine.

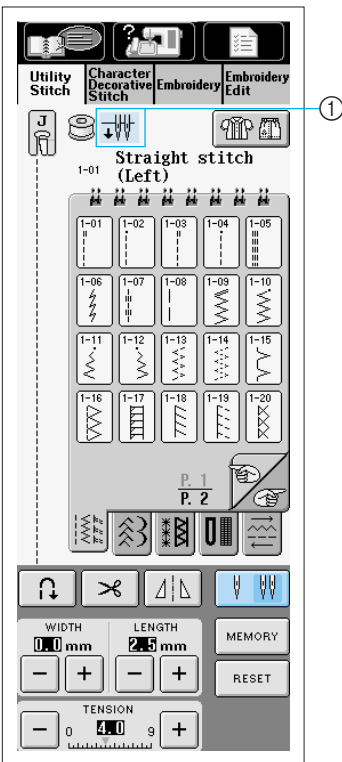

9. Select a stitch pattern. Refer to chart on page 3-1 through 3-8 for proper presser foot "J".

CAUTION

If the key is light gray after selecting the stitch, the selected stitch can not be sewn in twin needle mode.

10. Press to select twin needle mode.

① The appears next to the bobbin thread display.

CAUTION

Be sure to set the twin needle mode when using the twin needle. Using the twin needle while the machine is in single needle mode could cause the needle to break, resulting in damage.

11. Start sewing.

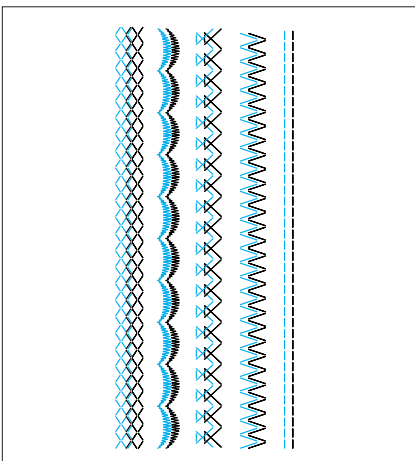

Sample of Twin Needle Sewing

STITCH SETTINGS

Setting Stitch Width for Zigzag Stitch Patterns

You can change the stitch width of each zigzag stitch. Normally, the machine automatically sets an appropriate zigzag stitch pattern width when the stitch pattern is selected. Follow the steps below when you want to change the zigzag stitch pattern width.

Note

It is not possible to change the width of some stitches (see page 2-10 for reference).

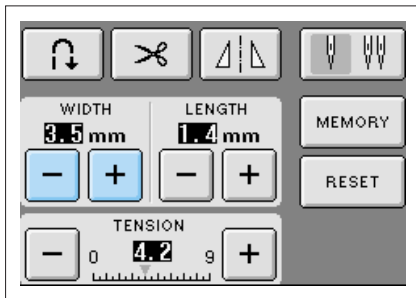

Press **-** to narrow the zigzag stitch pattern width. The value in the display gets smaller.

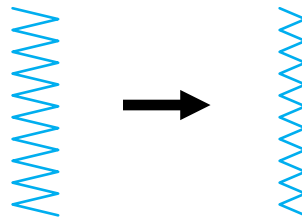

Press **+** to widen the zigzag stitch pattern width. The value in the display gets bigger.

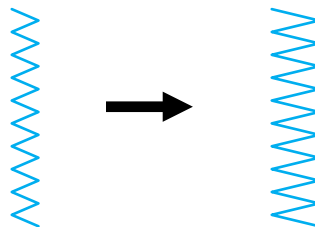

Note

For an alternate method of changing stitch width using the speed controller (see page 3-34).

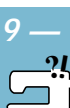

Setting the Stitch Length

Your machine automatically sets the stitch length when you select a stitch. However, there may be times when you want to change the stitch length. With this machine, you can change the length of each individual stitch in a seam.

Note

It is not possible to change the length of some stitches (see page 2-10 for reference).

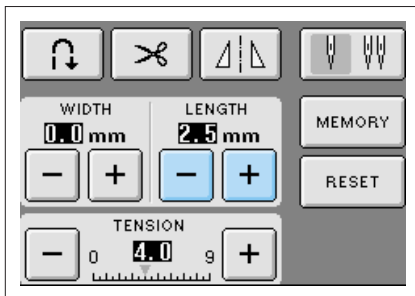

Press **-** to shorten the stitch length. The value in the display gets smaller.

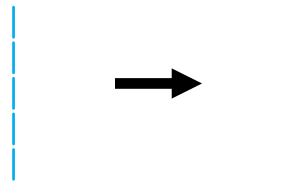



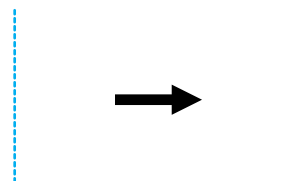





































Press **+** to lengthen the stitch length. The value in the display gets bigger.



⚠ CAUTION

If the stitches get bunched together, lengthen the stitch length and continue sewing. Do not continue sewing without lengthening the stitch length, otherwise the needle may break and cause injury.

■ Stitch Pattern Width/ Stitch Length Settings Table

Pattern	Stitch width [mm (inch.)]		Stitch length [mm (inch.)]		Pattern	Stitch width [mm (inch.)]		Stitch length [mm (inch.)]	
	Auto.	Manual	Auto.	Manual		Auto.	Manual	Auto.	Manual
	0.0 (0)	0.0 - 7.0 (0 - 1/4)	2.5 (3/32)	0.2 - 5.0 (1/64 - 3/16)		5.0 (3/16)	0.0 - 7.0 (0 - 1/4)	4.0 (3/16)	1.0 - 4.0 (1/16 - 3/16)
	0.0 (0)	0.0 - 7.0 (0 - 1/4)	2.5 (3/32)	0.2 - 5.0 (1/64 - 3/16)		6.0 (15/64)	1.0 - 7.0 (1/16 - 1/4)	3.0 (1/8)	1.0 - 4.0 (1/16 - 3/16)
	—	—	2.5 (3/32)	0.2 - 5.0 (1/64 - 3/16)		6.0 (15/64)	1.0 - 7.0 (1/16 - 1/4)	1.8 (1/16)	1.0 - 4.0 (1/16 - 3/16)
	—	—	2.5 (3/32)	0.2 - 5.0 (1/64 - 3/16)		0.0 (0)	0.0 - 2.5 (0 - 3/32)	2.5 (3/32)	0.2 - 5.0 (1/64 - 3/16)
	0.0 (0)	0.0 - 7.0 (0 - 1/4)	2.5 (3/32)	1.5 - 4.0 (1/16 - 3/16)		3.5 (1/8)	3.5 - 5.0 (1/8 - 3/16)	1.4 (1/16)	0.0 - 4.0 (0 - 3/16)
	1.0 (1/16)	1.0 - 3.0 (1/16 - 1/8)	2.5 (3/32)	1.0 - 4.0 (1/16 - 3/16)		3.5 (1/8)	3.5 - 5.0 (1/8 - 3/16)	2.0 (1/16)	1.0 - 4.0 (1/16 - 3/16)
	0.0 (0)	0.0 - 7.0 (0 - 1/4)	2.5 (3/32)	1.0 - 4.0 (1/16 - 3/16)		5.0 (3/16)	3.5 - 5.0 (1/8 - 3/16)	2.5 (3/32)	1.0 - 4.0 (1/16 - 3/16)
	0.0 (0)	0.0 - 7.0 (0 - 1/4)	20.0 (3/4)	5.0 - 30.0 (3/16 - 1-3/16)		5.0 (3/16)	3.5 - 5.0 (1/8 - 3/16)	2.5 (3/32)	1.0 - 4.0 (1/16 - 3/16)
	3.5 (1/8)	0.0 - 7.0 (0 - 1/4)	1.4 (1/16)	0.0 - 4.0 (0 - 3/16)		5.5 (7/32)	0.0 - 7.0 (0 - 1/4)	1.6 (1/16)	0.2 - 5.0 (1/64 - 3/16)
	3.5 (1/8)	0.0 - 7.0 (0 - 1/4)	1.4 (1/16)	0.0 - 4.0 (0 - 3/16)		1.5 (1/16)	0.0 - 7.0 (0 - 1/4)	1.6 (1/16)	0.2 - 5.0 (1/64 - 3/16)
	3.5 (1/8)	2.5 - 5.0 (3/32 - 3/16)	1.4 (1/16)	0.3 - 4.0 (1/64 - 3/16)		0.0 (0)	0.0 - 7.0 (0 - 1/4)	2.5 (3/32)	1.0 - 4.0 (1/16 - 3/16)
	3.5 (1/8)	2.5 - 5.0 (3/32 - 3/16)	1.4 (1/16)	0.3 - 4.0 (1/64 - 3/16)		3.5 (1/8)	0.0 - 7.0 (0 - 1/4)	1.4 (1/16)	0.0 - 4.0 (0 - 3/16)
	5.0 (3/16)	1.5 - 7.0 (1/16 - 1/4)	1.0 (1/16)	0.2 - 4.0 (1/64 - 1/16)		1.5 (1/16)	0.5 - 5.0 (1/64 - 3/16)	1.2 (1/16)	1.0 - 4.0 (1/16 - 3/16)
	5.0 (3/16)	1.5 - 7.0 (1/16 - 1/4)	1.0 (1/16)	0.2 - 4.0 (1/64 - 1/16)		7.0 (1/4)	1.0 - 7.0 (1/16 - 1/4)	1.6 (1/16)	1.0 - 4.0 (1/16 - 3/16)
	3.5 (1/8)	2.5 - 5.0 (3/32 - 3/16)	2.0 (1/16)	1.0 - 4.0 (1/16 - 3/16)		0.0 (0)	+3.0 - -3.0 (+1/8 - -1/8)	2.0 (1/16)	1.0 - 3.5 (1/16 - 1/8)
	5.0 (3/16)	2.5 - 5.0 (3/32 - 3/16)	2.5 (3/32)	1.0 - 4.0 (1/16 - 3/16)		0.0 (0)	+3.0 - -3.0 (+1/8 - -1/8)	2.0 (1/16)	1.0 - 3.5 (1/16 - 1/8)
	5.0 (3/16)	3.5 - 5.0 (1/8 - 3/16)	2.5 (3/32)	1.0 - 4.0 (1/16 - 3/16)		3.5 (1/8)	2.5 - 5.0 (3/32 - 3/16)	2.5 (3/32)	1.6 - 4.0 (1/16 - 3/16)
	5.0 (3/16)	0.0 - 7.0 (0 - 9/32)	2.5 (3/32)	0.5 - 4.0 (1/32 - 3/16)		4.0 (3/16)	0.0 - 7.0 (0 - 1/4)	2.5 (3/32)	0.2 - 4.0 (1/64 - 1/16)
	5.0 (3/16)	0.0 - 7.0 (0 - 9/32)	2.5 (3/32)	0.5 - 4.0 (1/32 - 3/16)		5.0 (3/16)	2.5 - 7.0 (3/32 - 1/4)	0.5 (1/32)	0.1 - 1.0 (1/64 - 1/16)
	4.0 (3/16)	0.0 - 7.0 (0 - 1/4)	4.0 (3/16)	1.0 - 4.0 (1/16 - 3/16)		7.0 (1/4)	0.0 - 7.0 (0 - 1/4)	1.4 (1/16)	1.0 - 4.0 (1/16 - 3/16)

1 —



2 —



3 —



4 —



5 —



6 —



7 —











































8 —



9 —



Pattern	Stitch width [mm (inch.)]		Stitch length [mm (inch.)]		Pattern	Stitch width [mm (inch.)]		Stitch length [mm (inch.)]	
	Auto.	Manual	Auto.	Manual		Auto.	Manual	Auto.	Manual
	4.0 (1/16)	0.0 - 7.0 (0 - 1/4)	1.2 (1/16)	0.2 - 4.0 (1/64 - 1/16)		5.0 (3/16)	1.5 - 7.0 (1/16 - 1/4)	3.5 (1/8)	1.5 - 4.0 (1/16 - 3/16)
	5.0 (3/16)	2.5 - 7.0 (3/32 - 1/4)	2.5 (3/32)	1.0 - 4.0 (1/16 - 3/16)		5.0 (3/16)	1.5 - 7.0 (1/16 - 1/4)	3.5 (1/8)	1.6 - 4.0 (1/16 - 3/16)
	5.0 (3/16)	0.0 - 7.0 (0 - 1/4)	1.2 (1/16)	0.2 - 4.0 (1/64 - 1/16)		5.0 (3/16)	1.5 - 7.0 (1/16 - 1/4)	4.0 (3/16)	1.5 - 4.0 (1/16 - 3/16)
	5.0 (3/16)	0.0 - 7.0 (0 - 1/4)	1.6 (1/16)	1.0 - 4.0 (1/16 - 3/16)		4.0 (3/16)	1.5 - 7.0 (1/16 - 1/4)	2.5 (3/32)	1.5 - 4.0 (1/16 - 3/16)
	5.0 (3/16)	0.0 - 7.0 (0 - 1/4)	2.5 (3/32)	1.0 - 4.0 (1/16 - 3/16)		5.0 (3/16)	1.5 - 7.0 (1/16 - 1/4)	2.5 (3/32)	1.0 - 4.0 (1/16 - 3/16)
	5.0 (3/16)	2.5 - 7.0 (3/32 - 1/4)	2.5 (3/32)	1.0 - 4.0 (1/16 - 3/16)		6.0 (15/64)	1.5 - 7.0 (1/16 - 1/4)	3.5 (1/8)	1.5 - 4.0 (1/16 - 3/16)
	4.0 (3/16)	0.0 - 7.0 (0 - 1/4)	1.0 (1/16)	0.2 - 4.0 (1/61 - 3/16)		6.0 (15/64)	1.5 - 7.0 (1/16 - 1/4)	1.6 (1/16)	1.0 - 4.0 (1/16 - 3/16)
	4.0 (3/16)	0.0 - 7.0 (0 - 1/4)	3.0 (1/8)	2.0 - 4.0 (1/16 - 3/16)		6.0 (15/64)	1.5 - 7.0 (1/16 - 1/4)	3.0 (1/8)	1.5 - 4.0 (1/16 - 3/16)
	4.0 (3/16)	0.0 - 7.0 (0 - 1/4)	2.5 (3/32)	1.0 - 4.0 (1/16 - 3/16)		6.0 (15/64)	1.5 - 7.0 (1/16 - 1/4)	4.0 (3/16)	1.5 - 4.0 (1/16 - 3/16)
	5.5 (3/16)	0.0 - 7.0 (0 - 1/4)	1.6 (1/16)	1.0 - 4.0 (1/16 - 3/16)		4.0 (3/16)	1.5 - 7.0 (1/16 - 1/4)	2.5 (3/32)	1.5 - 4.0 (1/16 - 3/16)
	5.0 (3/16)	1.5 - 7.0 (1/16 - 1/4)	1.0 (1/16)	0.2 - 4.0 (1/64 - 3/16)		5.0 (3/16)	1.5 - 7.0 (1/16 - 1/4)	2.0 (1/16)	1.5 - 4.0 (1/16 - 3/16)
	6.0 (15/64)	1.0 - 7.0 (1/16 - 1/4)	1.0 (1/16)	0.2 - 4.0 (1/64 - 3/16)		6.0 (15/64)	1.5 - 7.0 (1/16 - 1/4)	2.0 (1/16)	1.5 - 4.0 (1/16 - 3/16)
	7.0 (1/4)	1.0 - 7.0 (1/16 - 1/4)	1.6 (1/16)	1.0 - 4.0 (1/16 - 3/16)		5.0 (3/16)	1.5 - 7.0 (1/16 - 1/4)	3.0 (1/8)	1.5 - 4.0 (1/16 - 3/16)
	1.0 (1/16)	1.0 - 7.0 (1/16 - 1/4)	2.5 (3/32)	1.5 - 4.0 (1/16 - 3/16)		6.0 (15/64)	1.5 - 7.0 (1/16 - 1/4)	1.6 (1/16)	1.0 - 4.0 (1/16 - 3/16)
	3.5 (1/8)	1.0 - 7.0 (1/16 - 1/4)	2.5 (3/32)	1.5 - 4.0 (1/16 - 3/16)		5.0 (3/16)	1.5 - 7.0 (1/16 - 1/4)	1.6 (1/16)	1.0 - 4.0 (1/16 - 3/16)
	6.0 (15/64)	1.5 - 7.0 (1/16 - 1/4)	3.0 (1/8)	1.0 - 4.0 (1/16 - 3/16)		5.0 (3/16)	3.0 - 5.0 (1/8 - 3/16)	0.4 (1/64)	0.2 - 1.0 (1/64 - 1/16)
	3.5 (1/8)	1.5 - 7.0 (1/16 - 1/4)	2.5 (3/32)	1.6 - 4.0 (1/16 - 3/16)		5.5 (7/32)	3.5 - 5.5 (1/8 - 7/32)	0.4 (1/64)	0.2 - 1.0 (1/64 - 1/16)
	3.0 (1/8)	1.5 - 7.0 (1/16 - 1/4)	3.5 (1/8)	1.6 - 4.0 (1/16 - 3/16)		5.0 (3/16)	3.0 - 5.0 (1/8 - 3/16)	0.4 (1/64)	0.2 - 1.0 (1/64 - 1/16)
	6.0 (15/64)	1.5 - 7.0 (1/16 - 1/4)	3.0 (1/8)	1.5 - 4.0 (1/16 - 3/16)		5.0 (3/16)	3.0 - 5.0 (1/8 - 3/16)	0.4 (1/64)	0.2 - 1.0 (1/64 - 1/16)
	5.0 (3/16)	1.5 - 7.0 (1/16 - 1/4)	3.5 (1/8)	1.6 - 4.0 (1/16 - 3/16)		5.0 (3/16)	3.0 - 5.0 (1/8 - 3/16)	0.4 (1/64)	0.2 - 1.0 (1/64 - 1/16)

1 —



2 —



3 —



4 —



5 —



6 —



7 —





























8 —



9 —



Pattern	Stitch width [mm (inch.)]		Stitch length [mm (inch.)]		Pattern	Stitch width [mm (inch.)]		Stitch length [mm (inch.)]	
	Auto.	Manual	Auto.	Manual		Auto.	Manual	Auto.	Manual
	5.0 (3/16)	3.0 - 5.0 (1/8 - 3/16)	0.4 (1/64)	0.2 - 1.0 (1/64 - 1/16)		—	—	—	—
	5.0 (3/16)	3.0 - 5.0 (1/8 - 3/16)	0.4 (1/64)	0.2 - 1.0 (1/64 - 1/16)		—	—	—	—
	5.5 (7/32)	3.5 - 5.5 (1/8 - 7/32)	0.4 (1/64)	0.2 - 1.0 (1/64 - 1/16)		—	—	—	—
	5.0 (7/32)	3.0 - 5.0 (1/8 - 7/32)	0.4 (1/64)	0.2 - 1.0 (1/64 - 1/16)		—	—	—	—
	6.0 (15/64)	3.0 - 6.0 (1/8 - 15/64)	1.0 (1/16)	0.5 - 2.0 (1/32 - 1/16)		—	—	—	—
	6.0 (15/64)	3.0 - 6.0 (1/8 - 15/64)	1.5 (1/16)	1.0 - 3.0 (1/1 - 1/8)		—	—	—	—
	5.0 (3/16)	0.0 - 6.0 (0 - 15/64)	2.0 (1/16)	0.2 - 4.0 (1/64 - 3/16)		—	—	—	—
	7.0 (1/4)	3.0 - 7.0 (1/8 - 1/4)	0.5 (1/32)	0.3 - 1.0 (1/64 - 1/16)	* — : Non - adjustable				
	7.0 (1/4)	3.0 - 7.0 (1/8 - 1/4)	0.5 (1/32)	0.3 - 1.0 (1/64 - 1/16)					
	7.0 (1/4)	3.0 - 7.0 (1/8 - 1/4)	0.5 (1/32)	0.3 - 1.0 (1/64 - 1/16)					
	7.0 (1/4)	2.5 - 7.0 (3/32 - 1/4)	2.0 (1/16)	0.4 - 2.5 (1/64 - 1/16)					
	7.0 (1/4)	2.5 - 7.0 (3/32 - 1/4)	2.0 (1/16)	0.4 - 2.5 (1/64 - 1/16)					
	2.0 (1/16)	1.0 - 3.0 (1/16 - 1/8)	0.4 (1/64)	0.3 - 1.0 (1/64 - 1/16)					
	3.5 (1/8)	2.5 - 4.5 (3/32 - 3/16)	—	—					
	7.0 (1/4)	7.0 6.0 5.0 (1/4 15/64 3/16)	7.0 (1/4)	7.0 6.0 5.0 (1/4 15/64 3/16)					
	—	—	—	—					
	—	—	—	—					
	—	—	—	—					
	—	—	—	—					
	—	—	—	—					

1 —



2 —



3 —



4 —



5 —



6 —



7 —



8 —



9 —



Setting the Thread Tension

Your machine will automatically set the thread tension when you select a stitch. However, you may need to change the thread tension, depending on the fabric and thread being used.

■ Proper Thread Tension

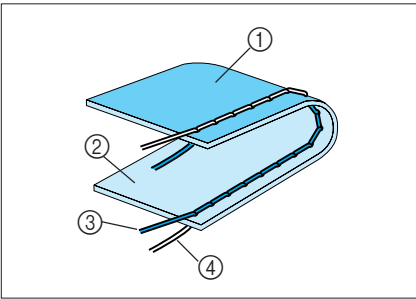

The upper and lower threads should cross near the center of the fabric. If thread tension is not properly set, the seam may have a poor finish or the fabric may pucker.

- ① Reverse side
- ② Surface
- ③ Upper thread
- ④ Bobbin thread

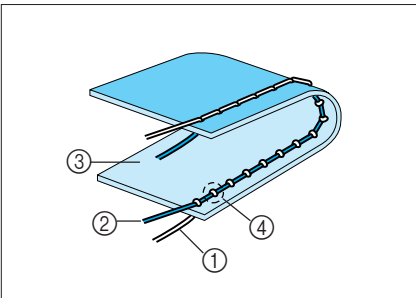
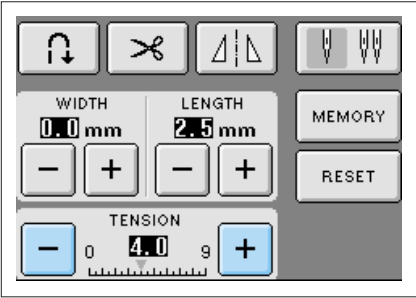

If the upper thread tension is too strong (the bobbin thread can be seen on the top side of the fabric), press the key.

- ① Bobbin thread
- ② Upper thread
- ③ Surface
- ④ Locks appear on surface of fabric

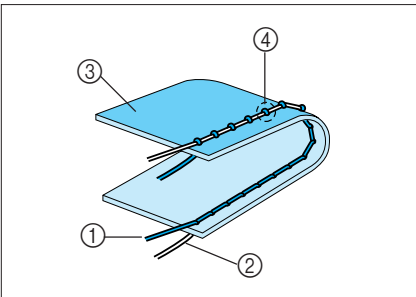

If the upper thread tension is too weak (the upper thread can be seen on the bottom side of the fabric), press the key.

- ① Upper thread
- ② Bobbin thread
- ③ Reverse side
- ④ Locks appear on reverse side of fabric

Note _____



If you change the thread tension setting, but turn off the power or select another stitch afterwards, the thread tension will return to the default setting.

MACHINE FUNCTION SETTINGS

Automatic Reinforcement Stitching

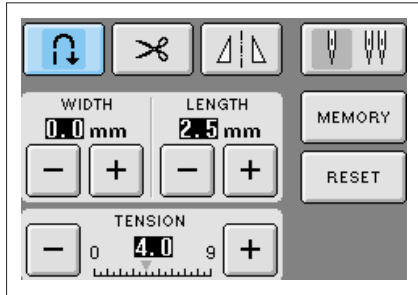
After selecting a stitch pattern, turn on the automatic reinforcement stitching function before sewing, and the machine will automatically sew reinforcement stitches (or reverse stitches, depending on the stitch pattern) at the beginning and end of sewing.



1. Select a stitch pattern.
2. Press  to set the automatic reinforcement stitching function. The key will display as .

Note *Some stitches, such as buttonholes and bar tacks, require reinforcement stitches at the beginning of sewing. If you select one of these stitches, the machine will automatically turn on this function (the key appears as  when the stitch is selected).*

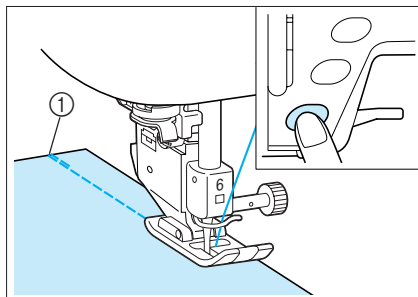

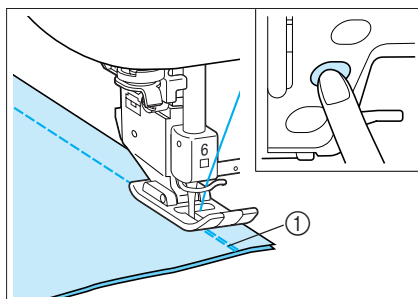

3. Set the fabric in the start position and start sewing. The machine will automatically sew reverse stitches (or reinforcement stitches) and then continue sewing.
 - ① Reverse stitches (or reinforcement stitches)

Note *If you press the "Start/Stop" button to pause sewing, press it again to continue. The machine will not sew reverse reinforcement stitches again.*



4. Press the "Reverse/Reinforcement Stitch" button. The machine will sew reverse stitches (or reinforcement stitches) and stop.

To turn off the automatic reinforcement stitching function, press  again, so it appears as .



- ① Reverse stitches (or reinforcement stitches)

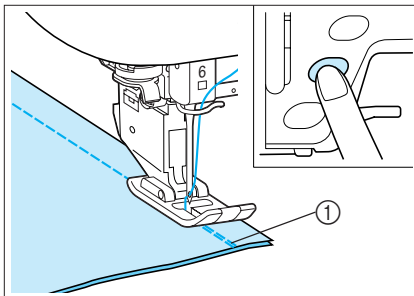
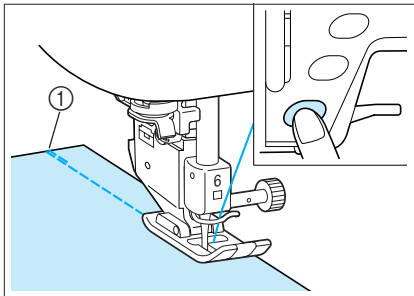
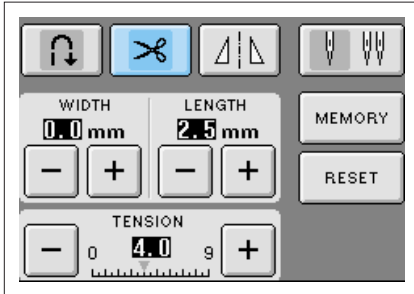

Using the Automatic Thread Cutter

After selecting a stitch pattern, turn on the automatic thread cutting function before sewing, and the machine will automatically sew reinforcement stitches (or reverse stitches, depending on the stitch pattern) at the beginning and end of sewing, and trim the threads at the end of sewing. This function is useful when sewing buttonholes and bar tacks.



1. Select a stitch pattern.
2. Press  to set the automatic thread cutting function. The key will display as .



Note

This function is set automatically when sewing embroidery.

3. Set the fabric in the start position and start sewing. The machine will automatically sew reverse stitches (or reinforcement stitches) and then continue sewing.
 - ① Reverse stitches (or reinforcement stitches)

Note

If you use the "Start/Stop" button to pause sewing, press the same button again to continue. The beginning reverse/reinforcement stitches will not be sewn again.

4. Press the "Reverse/Reinforcement Stitching" button. The machine will sew reverse stitches (or reinforcement stitches), then trim the thread. To turn off the automatic thread cutting function, press the  again, so it appears as .
 - ① Sews reverse stitches (or reinforcement stitches) and automatically trims the thread.



1 —



2 —



3 —



4 —



5 —



6 —



7 —



8 —































































9 —

































Chapter 3 Sewing Utility Stitches

QUICK REFERENCE TABLE

Pattern	Name of pattern	Type of presser foot	Use	Twin needle possibility
	Straight stitch (Left)		General sewing, gather, pintuck, etc. Reverse stitch is sewn while pressing "Reverse/Reinforcement Stitch" button.	OK (J)
	Straight stitch (Left)		General sewing, gather, pintuck, etc. Reinforcement stitch is sewn while pressing "Reverse/Reinforcement Stitch" button.	OK (J)
	Straight stitch (Middle)		General sewing, gather, pintuck, etc. Reverse stitch is sewn while pressing "Reverse/Reinforcement Stitch" button.	OK (J)
	Straight stitch (Middle)		General sewing, gather, pintuck, etc. Reinforcement stitch is sewn while pressing "Reverse/Reinforcement Stitch" button.	OK (J)
	Triple stretch stitch		General sewing for reinforcement and decorative topstitching	OK (J)
	Stem stitch		Reinforced stitching, sewing and decorative applications	OK (J)
	Decorative stitch		Decorative stitching, top stitching	OK (J)
	Basting stitch		Basting	NO
	Zigzag stitch		For overcasting, mending. Reverse stitch is sewn while pressing "Reverse/Reinforcement Stitch" button.	OK (J)
	Zigzag stitch		For overcasting, mending. Reinforcement stitch is sewn while pressing "Reverse/Reinforcement Stitch" button.	OK (J)
	Zigzag stitch (right)		Start from right needle position, zigzag sew at left.	OK (J)
	Zigzag stitch (left)		Start from left needle position, zigzag sew at right.	OK (J)
	2 step elastic zigzag		Overcasting (medium weight and stretch fabrics), tape and elastic	OK (J)
	3 step elastic zigzag		Overcasting (medium, heavyweight and stretch fabrics), tape and elastic	OK (J)
	Overcasting stitch		Reinforcing of light and medium weight fabrics	NO

Pattern	Name of pattern	Type of presser foot	Use	Twin needle possibility
	Overcasting stitch		Reinforcing of heavyweight fabric	NO
	Overcasting stitch		Reinforcing of medium, heavyweight and easily frayable fabrics or decorative stitching.	NO
	Overcasting stitch		Reinforced seaming of stretch fabric	OK (J)
	Overcasting stitch		Reinforcing of medium stretch fabric and heavyweight fabric, decorative stitching	OK (J)
	Overcasting stitch		Reinforcement of stretch fabric or decorative stitching	OK (J)
	Overcasting stitch		Stretch knit seam	NO
	Single diamond overcast		Reinforcement and seaming stretch fabric	OK (J)
	Single diamond overcast		Reinforcement of stretch fabric	OK (J)
	With side cutter		Straight stitch while cutting fabrics	NO
	With side cutter		Zigzag stitch while cutting fabrics	NO
	With side cutter		Overcasting stitch while cutting fabrics	NO
	With side cutter		Overcasting stitch while cutting fabrics	NO
	With side cutter		Overcasting stitch while cutting fabrics	NO
	Piecing stitch (right)		Piecework/patchwork 6.5 mm (1/4 inch) right seam allowance	NO
	Piecing stitch (left)		Piecework/patchwork 6.5 mm (1/4 inch) left seam allowance	NO

































Pattern	Name of pattern	Type of presser foot	Use	Twin needle possibility
	Hand-look quilting		Quilting stitch made to look like hand quilting stitch	NO
	Quilting appliqué zigzag stitch		Zigzag stitch for quilting and sewing on appliqué quilt pieces	NO
	Quilting appliqué stitch		Quilting stitch for invisible appliqué or attaching binding	NO
	Quilting stippling		Background quilting	NO
	Blind hem stitch		Hemming woven fabrics	NO
	Blind hem stitch stretch		Hemming stretch fabric	NO
	Blanket stitch		Appliqués, decorative blanket stitch	OK (J)
	Shell tuck edge		Shell tuck edge finish on fabrics	OK (J)
	Satin scallop stitch		Decorating collar of blouse, edge of handkerchief	OK (J)
	Scallop stitch		Decorating collar of blouse, edge of handkerchief	NO
	Patchwork join stitch		Patchwork stitches, decorative stitching	OK (J)
	Patchwork double overlock stitch		Patchwork stitches, decorative stitching	OK (J)
	Couching stitch		Decorative stitching attaching cord and couching	OK (J)
	Smocking stitch		Smocking, decorative stitching	OK (J)
	Feather stitch		Fagoting, decorative stitching	OK (J)

































Pattern	Name of pattern	Type of presser foot	Use	Twin needle possibility
	Fagoting cross stitch		Fagoting, bridging and decorative stitching	OK (J)
	Tape attaching		Attaching tape to seam in stretch fabric	OK (J)
	Ladder stitch		Decorative stitching	NO
	Rick-rack stitch		Decorative top stitching	OK (J)
	Decorative stitch		Decorative stitching	OK (J)
	Serpentine stitch		Decorative stitching and attaching elastic	OK (J)
	Decorative stitch		Decorative stitching and appliqué	OK (J)
	Decorative stippling stitch		Decorative stitching	NO
	Hemstitching		Decorative hems, triple straight at left	OK (J)
	Hemstitching		Decorative hems, triple straight at center	OK (J)
	Hemstitching zigzag		Decorative hems, top stitching	OK (J)
	Hemstitching		Decorative hems, lace attaching pin stitch	NO
	Hemstitching		Decorative hems	NO
	Hemstitching		Decorative hems daisy stitch	NO
	Hemstitching		Heirloom, decorative hems	NO



Pattern	Name of pattern	Type of presser foot	Use	Twin needle possibility
	Hemstitching		Heirloom, decorative hems	NO
	Hemstitching		Heirloom, decorative hems	OK (J)
	Hemstitching		Heirloom, decorative hems	OK (J)
	Hemstitching		Heirloom, decorative hems	OK (J)
	Honeycomb stitch		Heirloom, decorative hems	OK (J)
	Honeycomb stitch		Heirloom, decorative hems	OK (J)
	Hemstitching		Heirloom, decorative hems	OK (J)
	Hemstitching		Heirloom, decorative hems	NO
	Hemstitching		Heirloom, decorative hems	OK (J)
	Hemstitching		Heirloom, decorative hems	NO
	Hemstitching		Heirloom, decorative hems	OK (J)
	Hemstitching		Decorative hems and bridging stitch	OK (J)
	Hemstitching		Decorative hems. Fagoting attaching ribbon	OK (J)
	Hemstitching		Decorative hems, smocking	NO
	Hemstitching		Decorative hems, smocking	NO





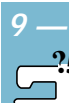

Pattern	Name of pattern	Type of presser foot	Use	Twin needle possibility
	Narrow rounded buttonhole		Buttonhole on light to medium weight fabrics	NO
	Wide round ended buttonhole		Buttonholes with extra space for larger buttons	NO
	Tapered round ended buttonhole		Reinforced waist tapered buttonholes	NO
	Round ended buttonhole		Buttonholes with vertical bar tack in heavyweight fabrics	NO
	Round ended buttonhole		Buttonholes with bar tack	NO
	Round double ended buttonhole		Buttonhole for fine, medium to heavyweight fabrics	NO
	Narrow squared buttonhole		Buttonholes for light to medium weight fabrics	NO
	Wide squared buttonhole		Buttonholes with extra space for larger decorative buttons	NO
	Squared buttonhole		Heavy-duty buttonholes with vertical bar tacks	NO
	Stretch buttonhole		Buttonholes for stretch or woven fabrics	NO
	Heirloom buttonhole		Buttonholes for heirloom and stretch fabrics	NO
	Bound buttonhole		The first step in making bound buttonholes	NO
	Keyhole buttonhole		Buttonholes in heavyweight or thick fabrics for larger flat buttons	NO
	Tapered keyhole buttonhole		Buttonholes in medium to heavy weight fabrics for larger flat buttons	NO
	Keyhole buttonhole		Buttonholes with vertical bar tack for reinforcement in heavyweight or thick fabrics	NO



Pattern	Name of pattern	Type of presser foot	Use	Twin needle possibility
	Darning		Darning of medium weight fabric	NO
	Darning		Darning of heavyweight fabric	NO
	Bar tack		Reinforcement at opening of pocket, etc.	NO
	Button sewing		Attaching buttons	NO
	Eyelet		For making eyelet, holes on belt, etc.	NO
	Diagonally left up (Straight)		For attaching appliqué on tubular pieces of fabric and mitering corners	NO
	Reverse (Straight)		For attaching appliqué on tubular pieces of fabric and mitering corners	NO
	Diagonally right up (Straight)		For attaching appliqué on tubular pieces of fabric and mitering corners	NO
	Sideways to left (Straight)		For attaching appliqué on tubular pieces of fabric	NO
	Sideways to right (Straight)		For attaching appliqué on tubular pieces of fabric	NO
	Diagonally left down (Straight)		For attaching appliqué on tubular pieces of fabric and mitering corners	NO
	Forward (Straight)		For attaching appliqué on tubular pieces of fabric and mitering corners	NO
	Diagonally right down (Straight)		For attaching appliqué on tubular pieces of fabric and mitering corners	NO
	Sideways to left (Zigzag)		For attaching appliqué on tubular pieces of fabric	NO
	Sideways to right (Zigzag)		For attaching appliqué on tubular pieces of fabric	NO



Pattern	Name of pattern	Type of presser foot	Use	Twin needle possibility
	Forward (Zigzag)		For attaching appliqué on tubular pieces of fabric and mitering corners	NO
	Reverse (Zigzag)		For attaching appliqué on tubular pieces of fabric and mitering corners	NO

▲ CAUTION

Make sure to use the correct presser foot for each stitch pattern. Otherwise, the needle may strike the presser foot and bend or break, causing injury.

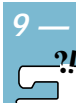

SELECTING UTILITY STITCHES

Selecting a Stitch Pattern

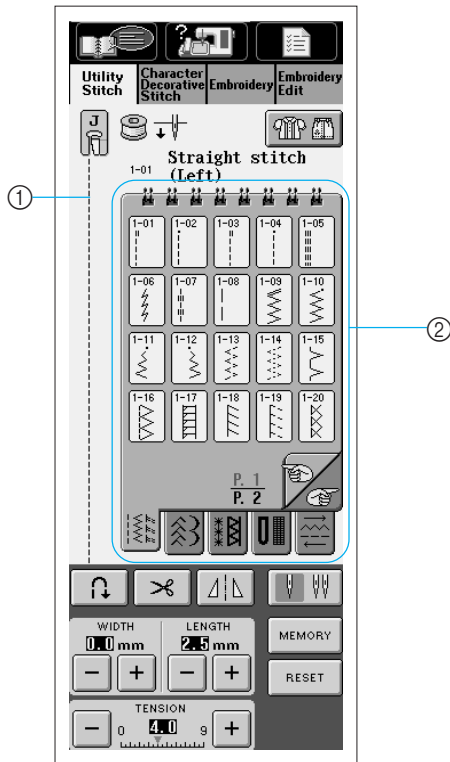

1. Turn the main power switch to ON. The screen shown at left is displayed. The often-used "1-01 Straight (left)" stitch pattern is automatically selected.

* Press **Utility Stitch** to view this screen if another screen displays.

2. Use  to find the stitch pattern you want.

- ① Preview of the selected stitch
- ② Stitch selection screen

3. Touch the key of the stitch pattern you want to sew to select it.

■ **Stitch Selection Screens**

Straight/Overcasting/Quilting Stitches

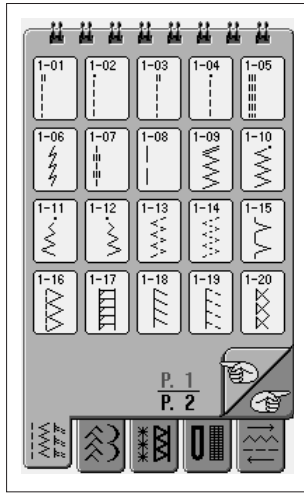

Decorative Stitches

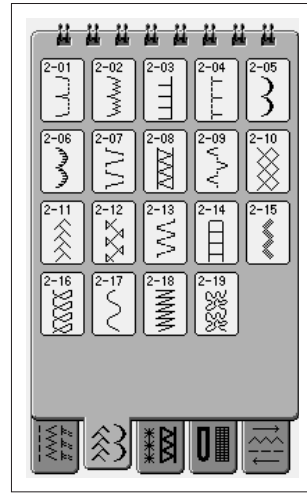

Press  to go to the next page.

Heirloom Stitches

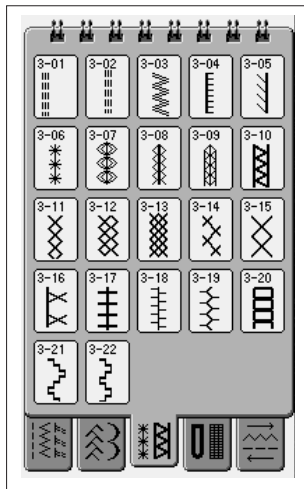

Buttonholes/Bar tacks

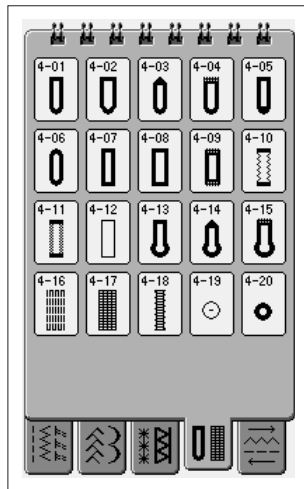

Multi-directional Sewing

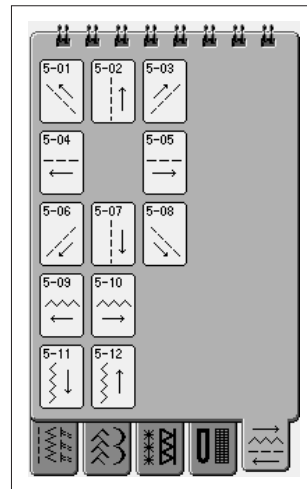

■ Using the Mirror Image Key

Depending on the type of utility stitch you select, you may be able to sew a horizontal mirror image of the stitch pattern.

If is lit when you select a pattern, it will be possible to make a mirror image of the pattern.

CAUTION

If is light gray after you select a stitch pattern, you can not create a horizontal mirror image of the selected stitch pattern (this is true of buttonholes, multi-directional sewing, and others).

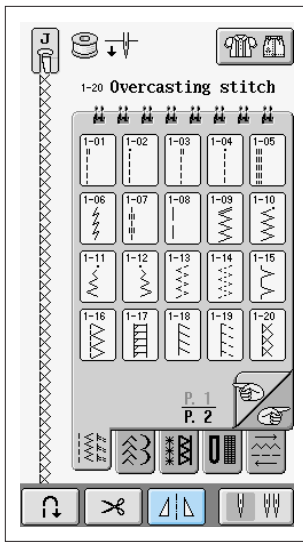

Press so it appears as to create a horizontal mirror image of the selected stitch pattern.

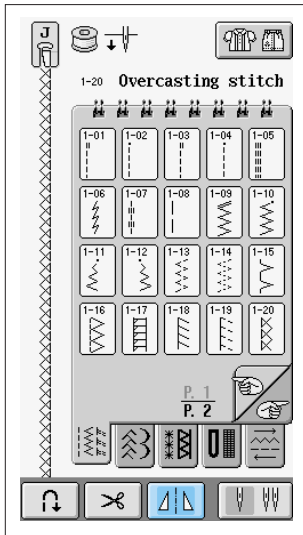
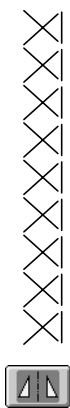
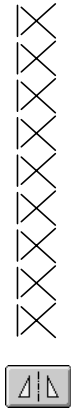

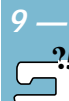

■ Saving Your Preferred Stitch Settings

The settings for zigzag stitch width, stitch length, thread tension, automatic thread cutting or automatic reinforcement stitching, etc., are preset by the computer for each stitch pattern. If you want to change those settings, input the new settings and press **MEMORY** for each pattern you want to change. The new settings will replace the computer settings.

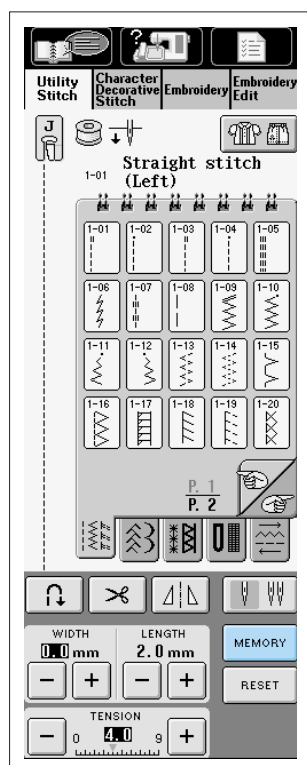

Example: You always use a length setting of 2.0 mm (1/16 inch) for a straight stitch

1. Select the straight stitch.
2. Set the length to 2.0 mm (1/16 inch), and press **MEMORY**.
3. Go back to the original screen, or turn off the machine. The next time you select the same straight stitch, the stitch length setting should be 2.0 mm, as you saved it.

CAUTION

- You can change any of the settings on the

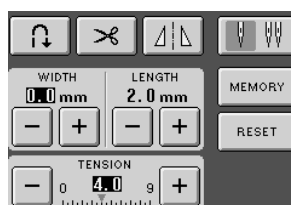

screen in the same manner.

- If you do not press **MEMORY** or **RESET** after saving the new stitch settings, the new stitch settings will be displayed whenever you select that stitch, even after turning off the power.

* Press **RESET** to return to the original machine settings.

Using the Sewing Type Selection Key



You can also select utility stitches using . Use this key when you are not sure which stitch to use for your application, or to get advice about sewing particular stitches. For example, if you want to sew overcasting, but you do not know which stitch to use or how to sew the stitch, you can use this screen to get advice. We recommend that beginners use this method to select patterns.

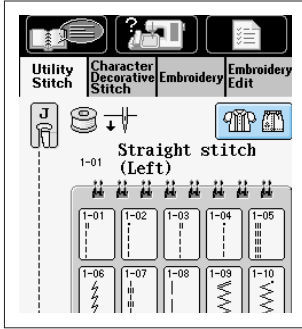

1. Press  to view the advice screen.

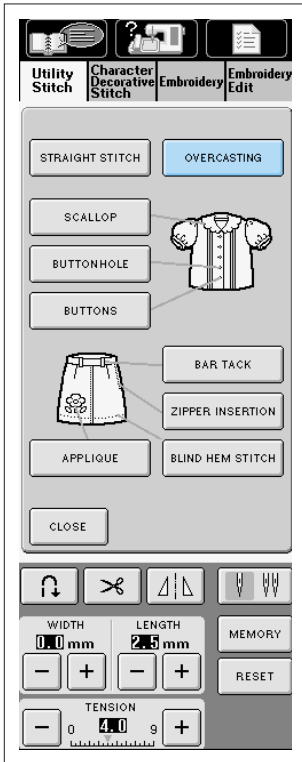

2. Press a key to see advice about that type of stitch or application.

Example: Displaying information about overcasting

* Press  to return to the original screen.



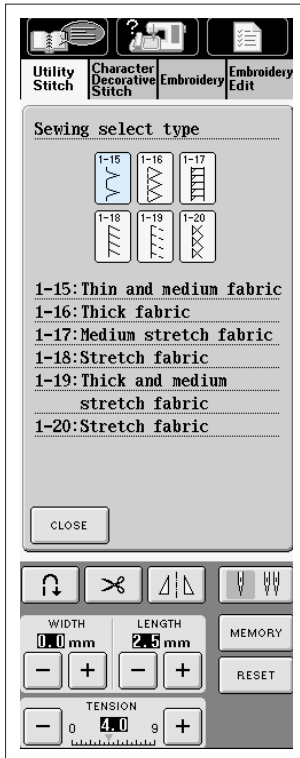

- The upper part of the screen displays a selection of overcasting stitches with explanations. Read the explanations and select the appropriate stitch.

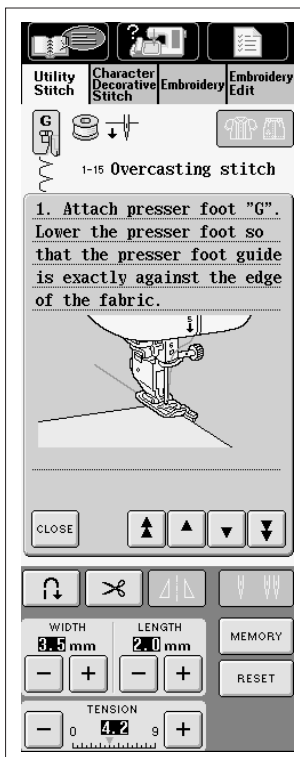

- The screen displays directions for sewing the selected stitch.

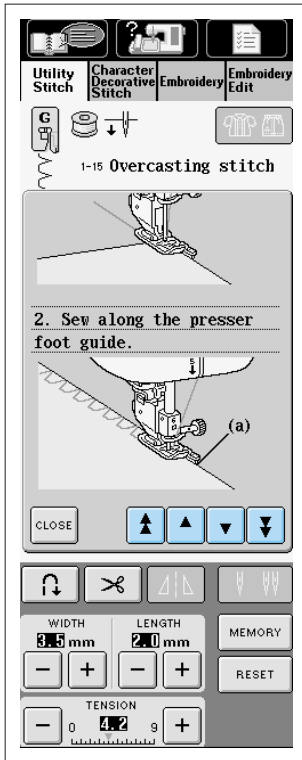

5. Press to scroll the screen in the direction of arrow selected, and see the next part of the instructions.

Press to scroll the screen 1 line at a time, in the direction of the arrow selected.

Press to scroll a larger section of the screen in the direction of the arrow selected.

Follow the directions to sew the stitch.

* Press at any time to return to the selection screen.





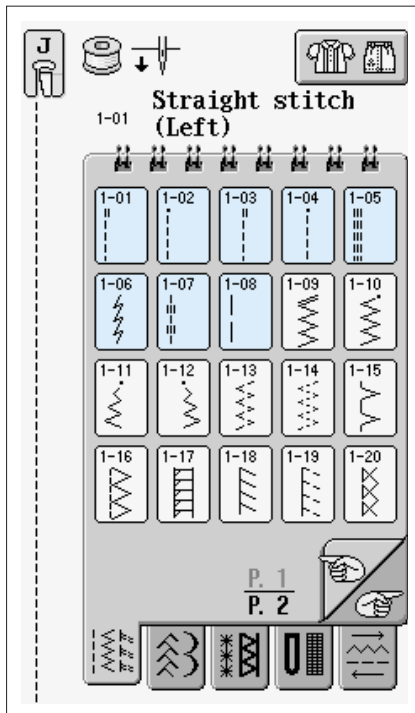





Straight Stitches



1. Select a stitch pattern.

If the stitch which you select has a double mark "II" at the top of the key display, you can sew reverse stitches holding the "Reverse/Reinforcement Stitch" button.

If the stitch which you select has a dot mark "•" at the top of the key display, you can sew reinforcement stitches holding the "Reverse/Reinforcement Stitch" button (see page 2-3).

-  1-01 Straight stitch (left needle position)
-  1-02 Straight stitch (left needle position)
-  1-03 Straight stitch (middle needle position)
-  1-04 Straight stitch (middle needle position)
-  1-05 Triple stretch stitch (left needle position)
-  1-06 Stem stitch for stretch fabrics (middle needle position)
-  1-07 Decorative straight stitch (left needle position)
-  1-08 Basting stitch (left needle position)

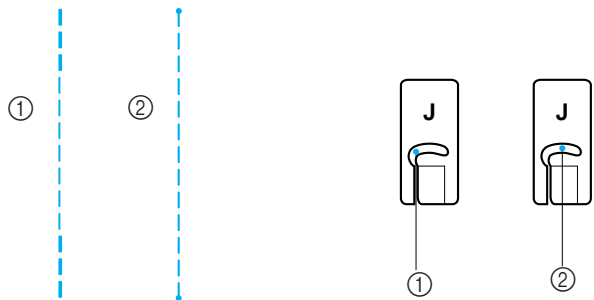

- ① Reverse stitch
- ② Reinforcement stitch
- ① Left needle position
- ② Middle needle position



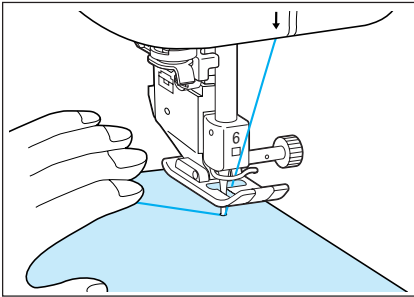

2. Attach presser foot "J". Hold the thread tails and fabric with your left hand, and turn the balance wheel with your right hand to insert the needle into the fabric. This is the sewing start position.

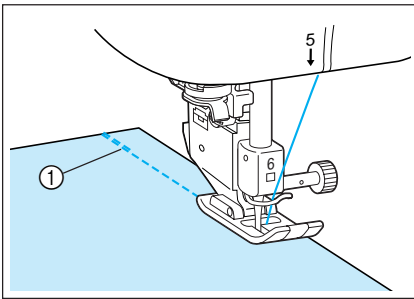

3. Lower the presser foot, and hold the "Reverse/Reinforcement Stitch" button to sew 3-4 stitches. After the machine sews reverse stitches (or reinforcement stitches), press the "Start/Stop" button to sew forward. The machine will begin sewing slowly.

① 3 - 4 reverse stitches

▲ CAUTION

Be sure the needle does not strike a basting pin, or any other objects, during sewing. The thread could tangle or the needle could break, causing injury.

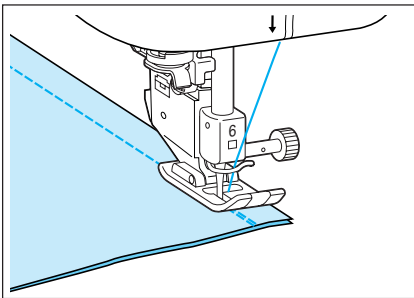

4. When sewing is completed, hold the "Reverse/Reinforcement Stitch" button to sew 3-4 reverse stitches (or reinforcement stitches) at the end of seam.

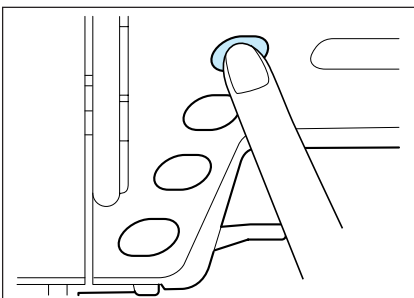

5. After sewing, press the "Thread Cutter" button to trim the threads.

* When the automatic thread cutting and automatic reinforcement stitch keys on the screen are selected, reverse stitches (or reinforcement stitches) will be sewn automatically at the start of sewing when pressing the "Start/Stop" button. Press the "Reverse/Reinforcement Stitch" button to sew reverse stitches (or reinforcement stitches) and trim the thread automatically at the finish of sewing.



■ Changing the Needle Position (Left Needle Position Patterns Only)

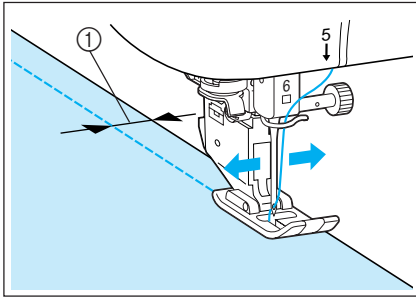

When you select left needle position stitch patterns, you can use **-** and **+** in the Stitch Width display to change the position of the needle. Match the distance from the right edge of the presser foot to the needle with the stitch width, then align the edge of the presser foot with the edge of the fabric during sewing for an attractive finish.

① Stitch width

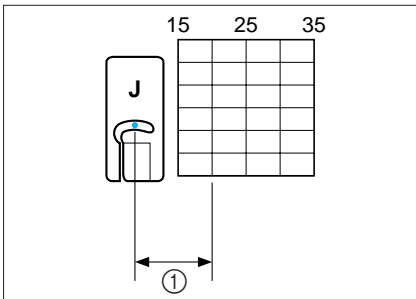
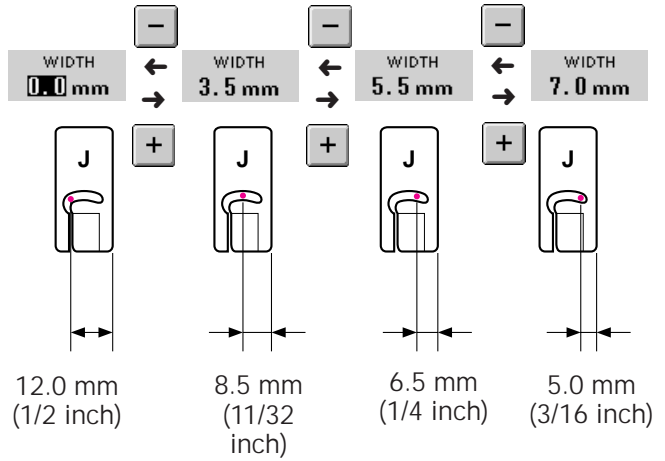

For standard 16 mm (5/8 inch) seam allowance, set **WIDTH 3.5 mm** on LCD.

① 16 mm (5/8 inch)



Basting

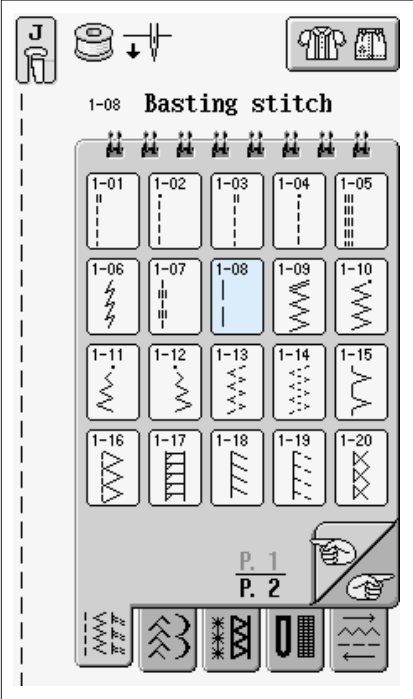

1. Select

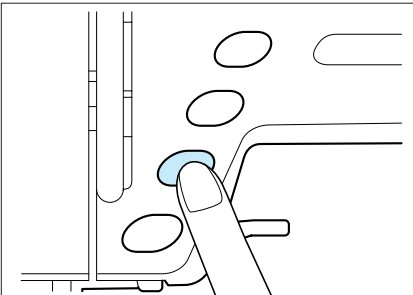

2. Attach presser foot "J". Press the "Reverse/ Reinforcement Stitch" button to sew reinforcement stitches, then continue sewing.

Note

- If you do not want to use a reinforcement stitch at the beginning, you should lift the presser foot, rotate the balance wheel, pull up the bobbin thread and pull a length of top and bobbin thread out from the rear of the machine.
- You can set the stitch length between 5 mm (3/16 inch) and 30 mm (1-3/16 inch)
 - ① Between 5mm (3/16 inch) and 30 mm (1-3/16 inch)

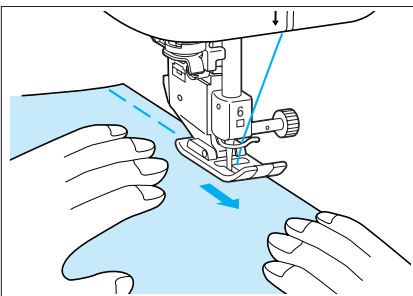
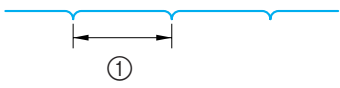

3. Sew while keeping the fabric pulled tight.
4. End the basting with reinforcement stitches.

Zigzag Stitches

Zigzag stitches are useful for overcasting, appliqué, patchwork, and many other applications.

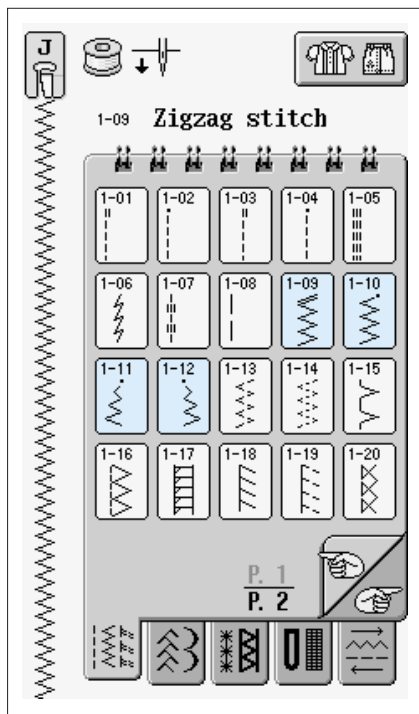

Select a stitch pattern, and attach presser foot "J".

If the stitch which you select has a double mark "II" at the top of the key display, you can sew reverse stitches holding the "Reverse/Reinforcement Stitch" button.

If the stitch which you select has a dot mark "■" at the top of the key display, you can sew reinforcement stitches holding the "Reverse/Reinforcement Stitch" button (see page 2-3).

1-09 Zigzag stitch pattern
To adjust the zigzag width, use the WIDTH key. The size of the width is the same distance on both sides of the center needle position.

1-10 Zigzag stitch pattern
To adjust the zigzag width, use the WIDTH key. The size of the width is the same distance on both sides of the center needle position.

1-11 Zigzag stitch pattern
To adjust the zigzag width, use the WIDTH key. The RIGHT side of the zigzag is stationary. The width change is from right to left.

1-12 Zigzag stitch pattern
To adjust the zigzag width, use the WIDTH key. The LEFT side of the zigzag is stationary. The width change is from left to right.

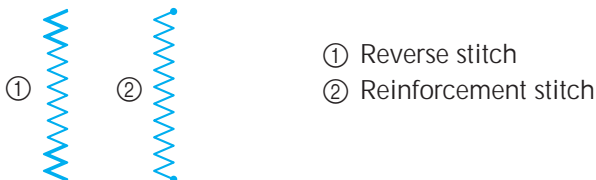

Overcasting (Using a Zigzag Stitch)

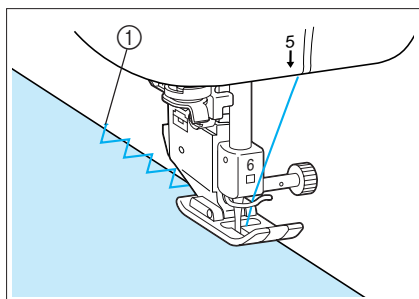

Sew the overcasting along the edge of the fabric so that the right-hand side needle drop point is over the edge of the fabric.

① Needle drop position



■ Appliqué (Using a Zigzag Stitch)

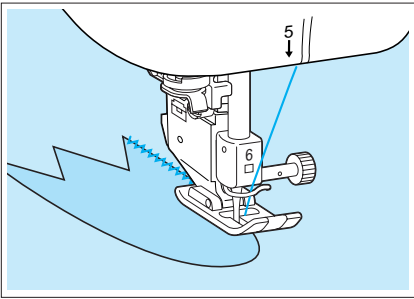

Attach the appliqué using a temporary spray adhesive or basting, then sew it.

* Sew a zigzag stitch while positioning the right hand needle drop point just outside the edge of the fabric.

■ Patchwork (for Crazy Quilt)

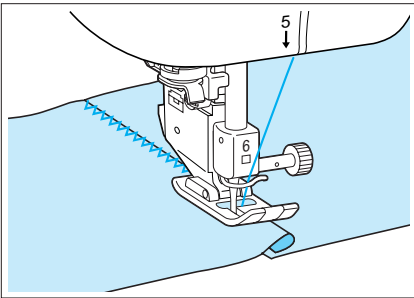

Turn back the desired width of fabric and position it over the lower fabric, then sew so that the stitch bridges both pieces of fabric.

■ Sewing Curves (Using a Zigzag Stitch)

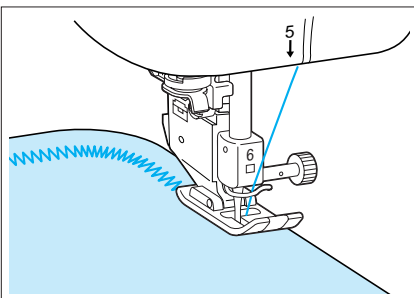

Shorten the stitch length setting to obtain a fine stitch. Sew slowly, keeping the seams parallel with the fabric edge as you guide the fabric around the curve.



Elastic Zigzag Stitches

Use elastic zigzag stitches for tape attaching, overcasting, darning, or a wide variety of other uses.

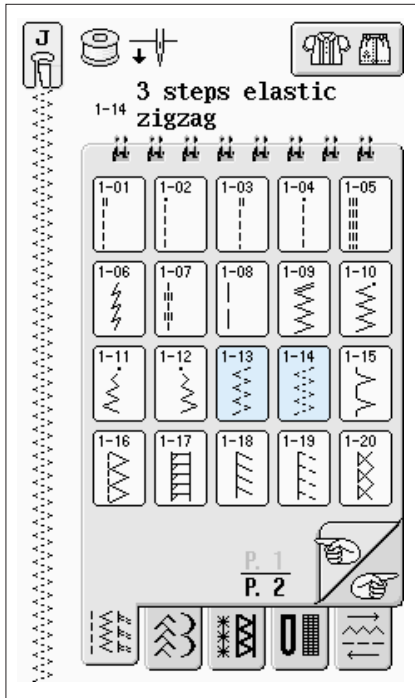

1. Select a stitch pattern, and attach presser foot "J".

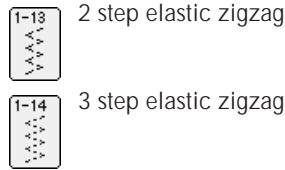

■ Tape Attaching

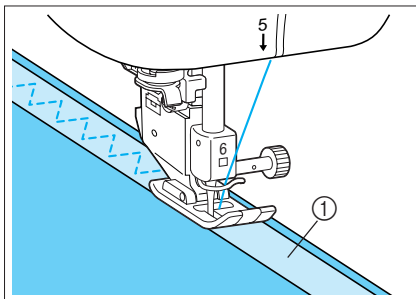

Stretch the tape flat. While stretching the tape flat, sew the tape to the fabric.

① Tape

■ Overcasting

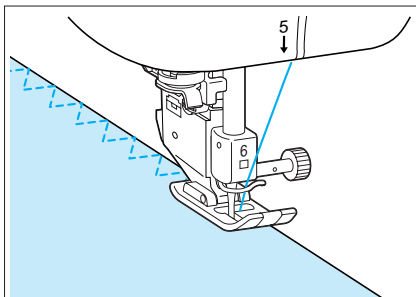

Use this stitch to sew overcasting on the edge of stretch fabrics. Sew the overcasting along the edge of the fabric with the needle dropping off the edge of the fabric at the right.



Overcasting

Use for the beginning and end of seams in skirts or trousers, and the beginning and end of all cuttings. Use presser foot “G”, presser foot “J”, or the side cutter attachment depending on the kind of overcasting stitch you select.

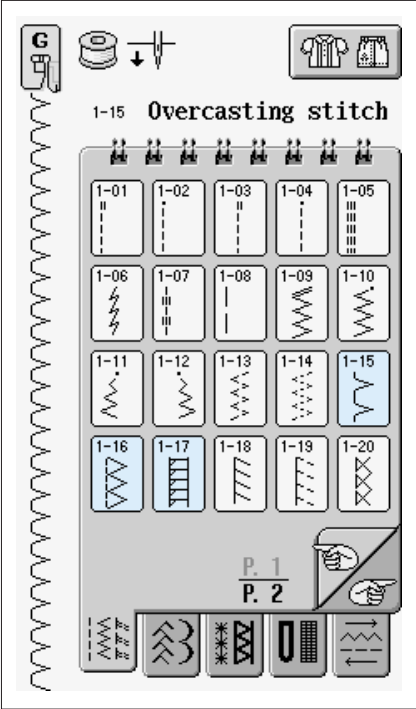
Overcasting Using Presser Foot “G”



1. Select a stitch pattern.

-  1-15 For sewing light and medium weight fabrics
-  1-16 For sewing heavyweight fabrics
-  1-17 For sewing medium or heavyweight and easily-frayable fabric

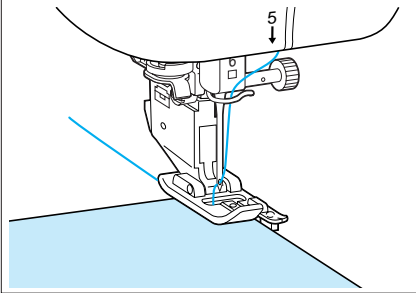

2. Attach presser foot “G”. Lower the presser foot so that the presser foot guide is exactly against the edge of the fabric.

3. Sew along the presser foot guide.

① Guide

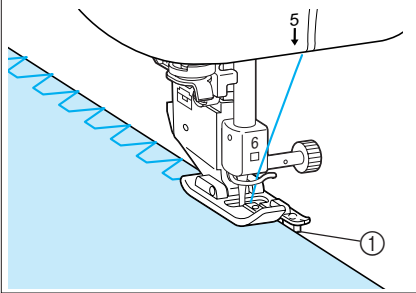

CAUTION

After the stitch width is adjusted, turn the balance wheel toward you by hand and check that the needle does not touch the presser foot. If the needle hits the presser foot the needle may break and cause injury.

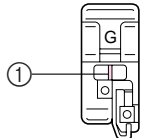

① The needle should not touch

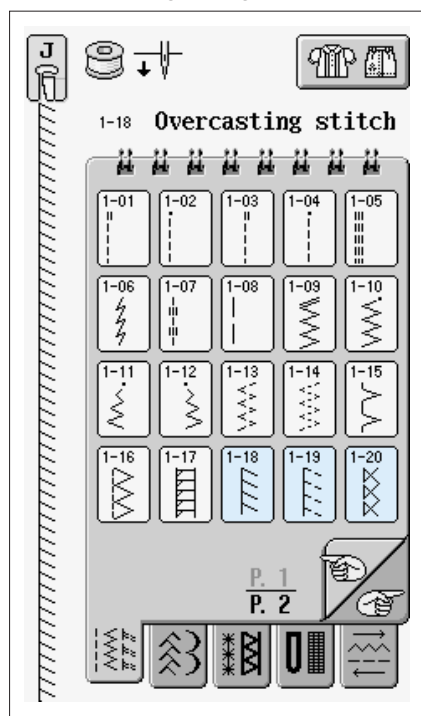

Overcasting Using Presser Foot "J"



1. Select a stitch pattern.

-  1-18 For sewing stretch fabrics
-  1-19 For sewing medium stretch fabrics and heavyweight fabrics
-  1-20 For sewing stretch fabrics
-  1-21 For sewing knit stretch fabrics
-  1-22 For sewing stretch fabrics
-  1-23 For sewing stretch fabrics

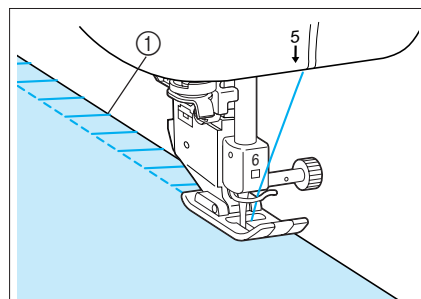

2. Attach presser foot "J". Sew with the needle dropping slightly off the edge of the fabric.

① Needle drop position

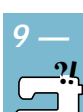

■ Overcasting Using the Side Cutter

By using the side cutter, you can do overcasting while cutting the fabrics.

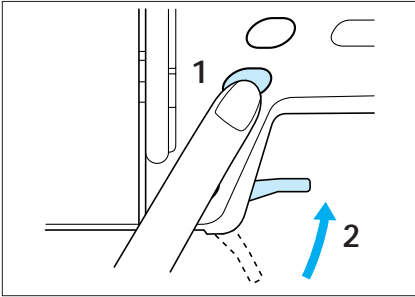

1. Push the "Needle Position" button to raise the needle, then turn off the power.
2. Raise the presser foot lever.

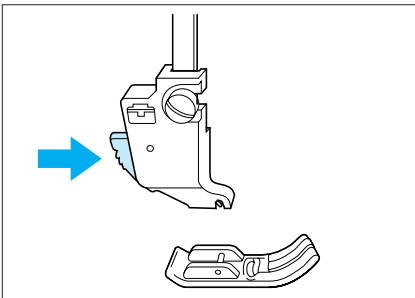

3. Press the black button on the presser foot holder, and remove the presser foot.

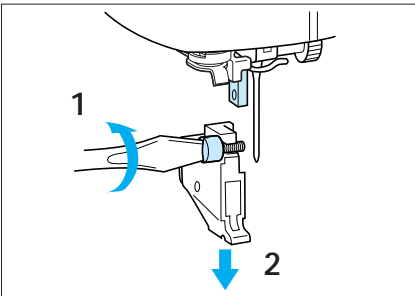

4. Use the included screwdriver to loosen the screw of the presser foot holder, and remove the presser foot holder.

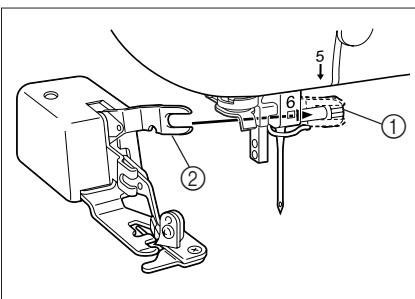

5. Set the fork of the operating lever around the needle clamp screw.
 - ① Needle clamp screw
 - ② Operating lever

* Make sure that the fork of the operating lever is set onto the screw firmly.



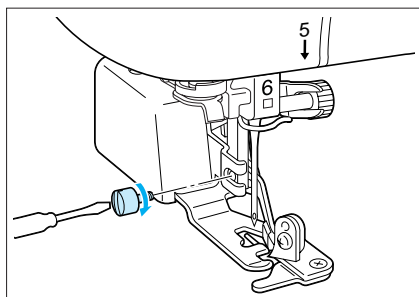

5. With the presser foot raised, align the presser foot holder screw hole directly with the notch in the side cutter, then insert the screw and lightly tighten it. Lower the presser foot lever and firmly tighten the screw.

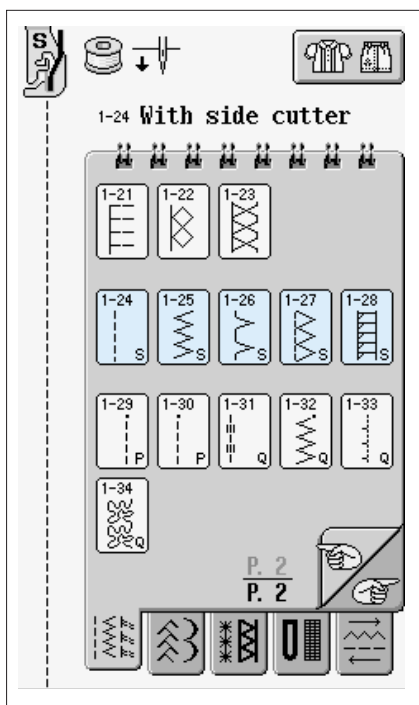

6. Select a stitch pattern. If there is an "S" in the bottom of the key display, the indicated stitch pattern can be sewn with the side cutter.

- 1-24 Normal sewing
- 1-25 Zigzag stitch
- 1-26 Overcasting stitch for light and medium weight fabrics
- 1-27 Overcasting stitch for heavyweight fabrics
- 1-28 Overcasting stitch for medium and heavyweight stretch fabrics

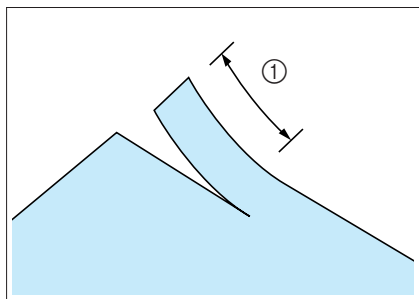

7. Make a cut of about 20 mm (3/4 inch) in the fabric.
① 20 mm (3/4 inch)



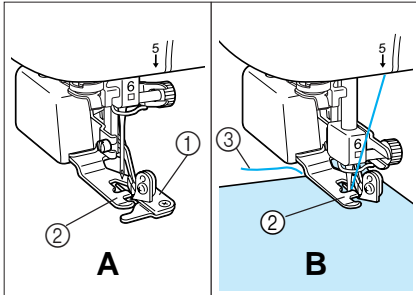

8. Place the fabric as shown left figure B.
- Right side of cut: on top of the guide plate
 - Left side of cut: underneath the presser foot

- ① Guide plate (lower knife)
- ② Presser foot

9. Thread the needle, then pull out a long section of the upper thread, pass it below the presser foot and pull it out in the fabric feed direction (see left figure B).

- ② Presser foot
- ③ Upper thread

10. Lower the presser foot lever.

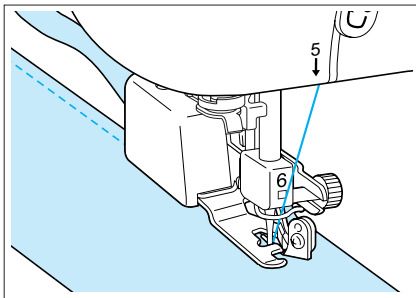

CAUTION

If the width has been adjusted, turn the balance wheel by hand to check that the needle does not touch the side cutter. If the needle touches the side cutter, it may cause the needle to break.

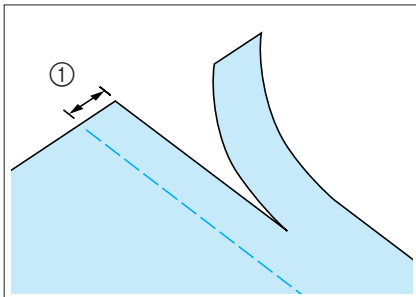

When Sewing Straight Stitches only

The seam margin should be about 5 mm (3/16 inch).

- ① Seam margin

- * Make sure you select a pattern for the side cutter.
- * Clean the side cutter after use, to avoid having dust and scraps of thread build up on it.
- * Add a small amount of oil as required to the cutting edge of the cutter.

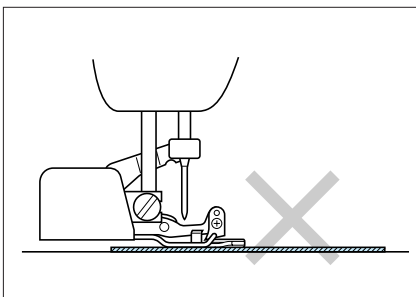

Note

- The fabric will not be cut if the whole fabric is simply spread out underneath the presser foot guide plate. Set the fabric as explained in step 8, and then start sewing.
- Check that the needle is raised when the presser foot lever is raised.
- One layer of 13 oz. denim can be cut.



Quilting

You can make beautiful quilts quickly and easily with this machine. When making a quilt, you will find it convenient to use the knee lifter and foot controller (see pages 1-6, 1-7) to free your hands for other tasks.

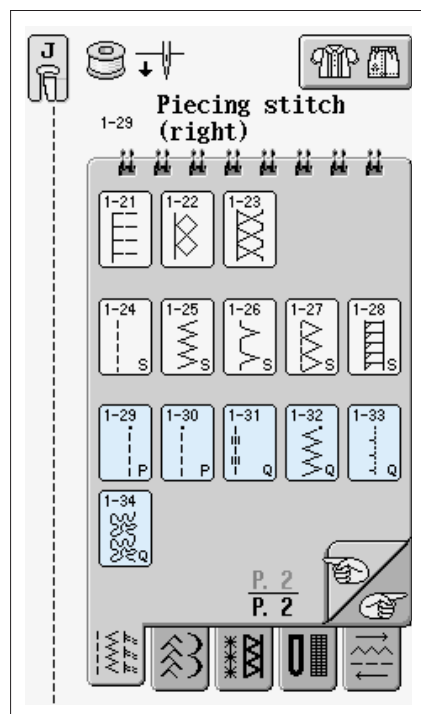

If there is a "P" or "Q" at the bottom of the key display, the indicated stitch pattern is intended for quilting.

1-29 Piecing straight stitch "RIGHT"
Straight stitch for piecing. The default stitch length is 1.6 mm (1/16 inch). Default stitch width (needle position) is 5.5 mm (7/32 inch). The stitch is set short to keep the stitching from coming loose during construction of the quilt block.

This is a 6.5 mm (1/4 inch) seam allowance when placing the edge of the fabric along the right edge of the presser foot (see Illustration Ⓐ on page 3-29).

1-30 Piecing straight stitch "LEFT"
Straight stitch for piecing. The default stitch length is 1.6 mm (1/16 inch). Default stitch width (needle position) is 1.5 mm (1/16 inch). The stitch is set short to keep the stitching from coming loose during construction of the quilt block.

This is a 6.5 mm (1/4 inch) seam allowance when placing the edge of the fabric along the left edge of the presser foot (see Illustration Ⓑ on page 3-29).

1-31 Hand look quilting stitch
You can create the appearance of a hand quilted look by using transparent nylon thread in the needle and bobbin thread matching the color of the quilt. When using with the nylon thread, strengthen the upper thread tension. Use this stitch for quilting small to large projects.

1-32 Quilting appliqué zigzag stitch
Use this stitch to appliqué quilt blocks, garments, etc. Press the "Reverse/Reinforcement Stitch" button to sew reinforcement stitches at the beginning and end of appliqué.

1-33 Quilting appliqué stitch
Use this stitch for "invisible" appliqué or attaching binding.

1-34 Quilting Stippling stitch
Use this stitch to quilt small areas such as vests, jackets, pillows, etc.

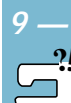

■ Piecing

Sewing two pieces of fabric together is called piecing. When cutting pieces for quilt blocks make sure the seam allowance is 6.5 mm (1/4 inch).

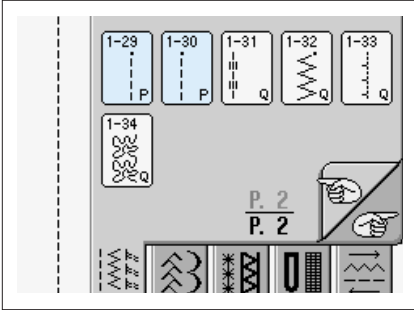

1. Select or , and attach presser foot "J".

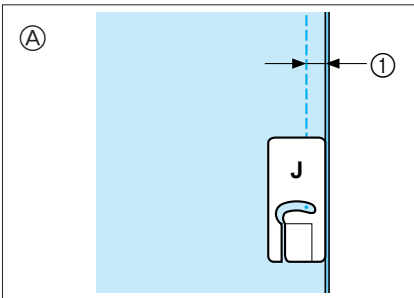

- Ⓐ To align a 6.5 mm (1/4 inch) seam allowance with the right edge of the presser foot.

(Stitch 1-29)



① 6.5 mm (1/4 inch)

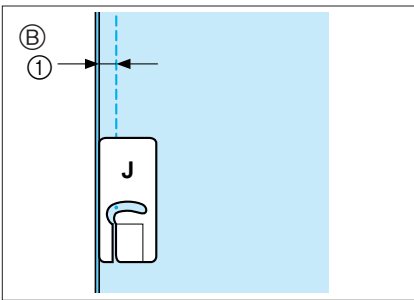

- Ⓑ To align a 6.5 mm (1/4 inch) seam allowance with the left edge of the presser foot.

(Stitch 1-30)



① 6.5 mm (1/4 inch)

2. Align the edge of the fabric with the edge of the presser foot, and start sewing.

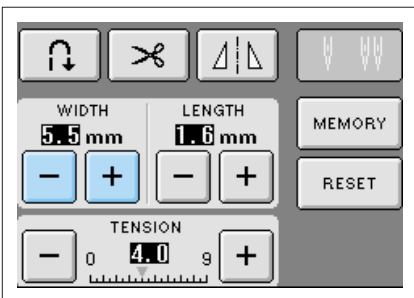

To change the needle position use or in the width display.

■ Quilting

Sewing together the quilt front, batting, and backing is called quilting. You can sew the quilt with the walking foot to keep the quilt front, batting, and backing from sliding. Your walking foot has a set of feed dogs that match the reaction of the feed dogs that rise above the surface of the needle plate as you sew.

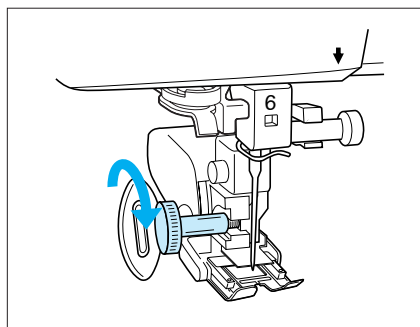

1. Attach the walking foot (see page 1-40).

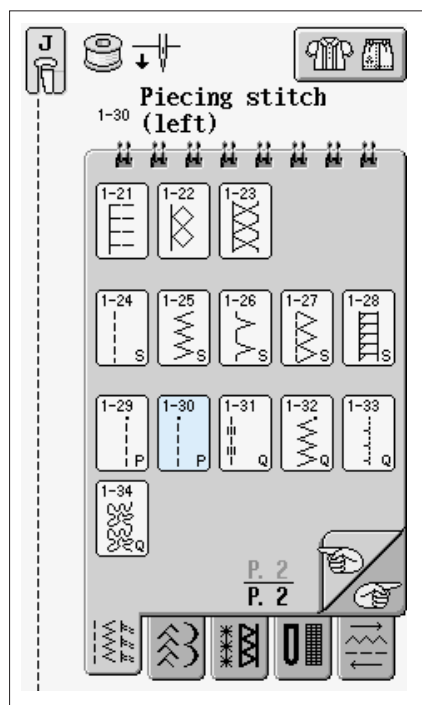

2. Select or .

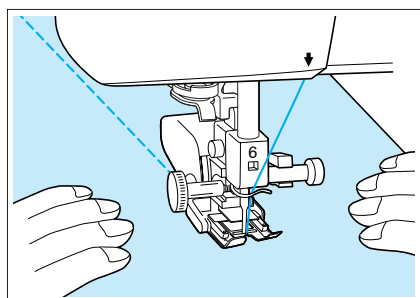

3. Place one hand on each side of the presser foot to hold the fabric securely. Sew while holding the fabric.

Note

- Sew in slow to medium speed.
- Do not sew in reverse or use stitches that require side ways feeding. Always check to be sure that your quilting surface is securely basted before beginning to sew. Machine quilt specialized needles and threads are also available for machine quilting.

■ Appliqué

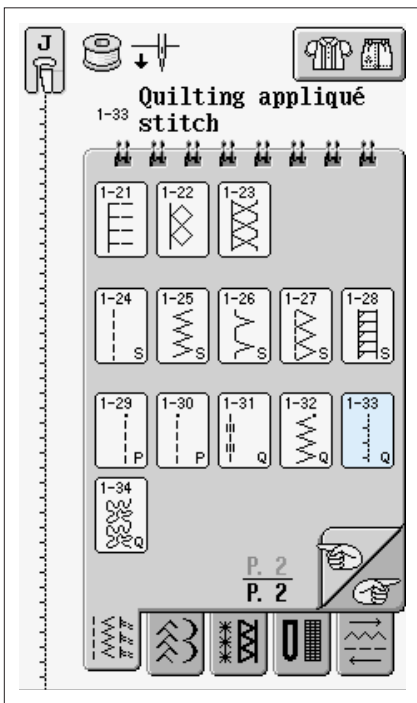
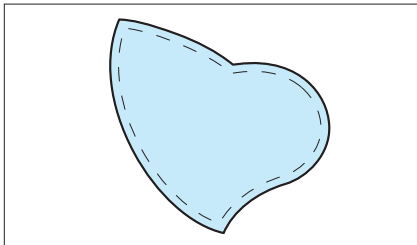
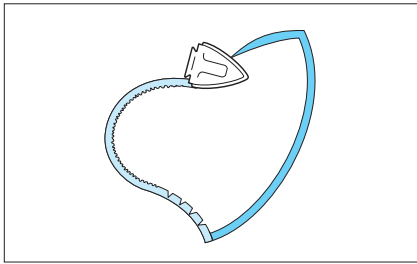
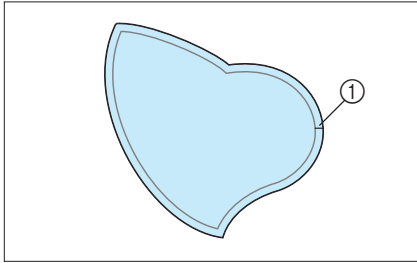

1. Trace the pattern onto the appliqué fabric and then cut around it, leaving 3 to 5 mm (1/8 to 3/16 inch) seam allowance.

① Seam allowance : 3 to 5 mm (1/8 to 3/16 inch)

2. Place a piece of thick paper cut to the finished size of the appliqué design onto the fabric, and then fold over the seam margin using an iron. Clip curves when necessary.

3. Turn the appliqué over, and attach the thick paper with basting pins or a basting stitch.

4. Select , and attach presser foot "J".

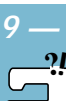

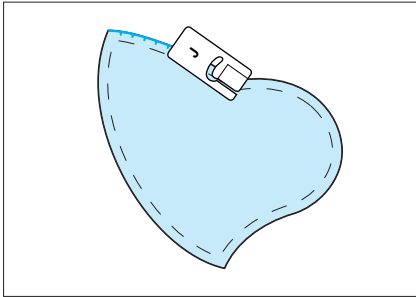

5. Use the quilting appliqué stitch to attach the appliqué. Sew around the edge, while dropping the needle as close to the edge as possible.



⚠ CAUTION
Be careful that the needle does not strike a basting pin during sewing. Striking a pin can cause the needle to break, resulting in injury.

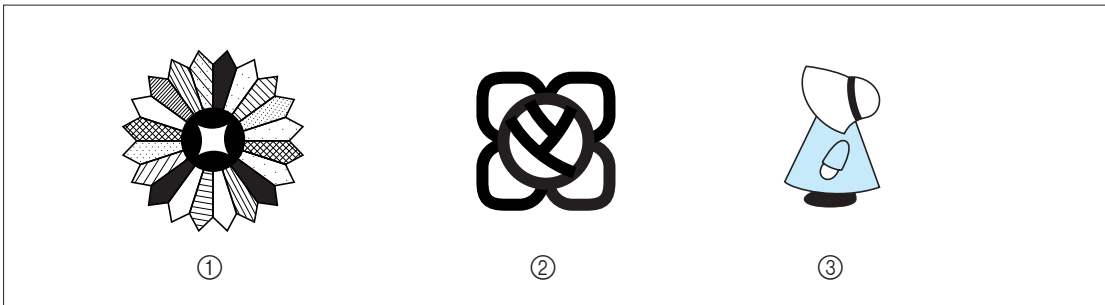

- ① Dresden plate
- ② Stained glass
- ③ Sunbonnet sue



■ Quilting with Satin Stitches

Use the foot controller to sew with satin stitch. If you set the speed control lever to control the stitch width, you can make subtle changes in the stitch width during sewing.

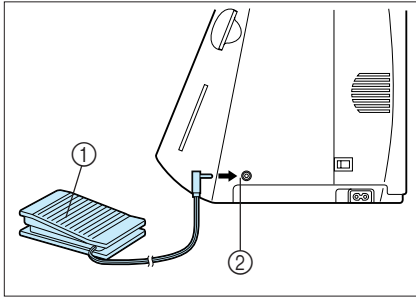

1. Attach the foot controller.

- ① Foot controller
- ② Foot controller jack

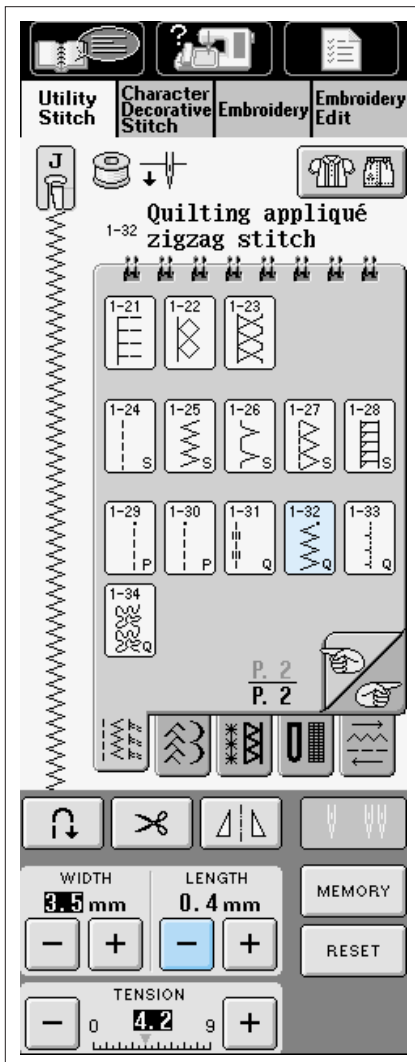



2. Select , and attach presser foot "J".

3. Press  in the LENGTH display to shorten the stitch length.

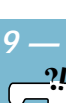
* The setting will vary according to the kind of fabric and the thickness of the thread, but a length of 0.3 to 0.5 mm (1/64 to 1/32 inch) is best for satin stitch patterns.

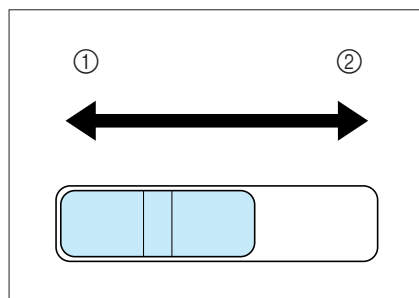
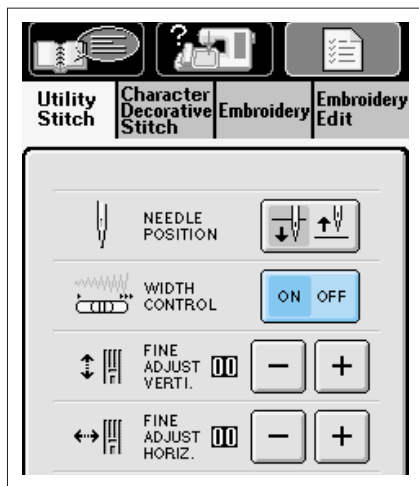



4. Set the speed control slide to control the stitch width. Press .

5. In the  display, change the setting to "ON."

During this process:
 * You can use the speed control slide to adjust the stitch width.
 * Use the foot controller to adjust the sewing speed.

6. Press  to return to the original screen.

7. You can adjust the stitch width during sewing by moving the sewing speed controller. Slide the lever to the left, and the stitch width becomes narrower. Slide it to the right, the stitch width becomes wider. The size of the width changes equally on both sides of the middle needle position.

- ① narrower
- ② wider

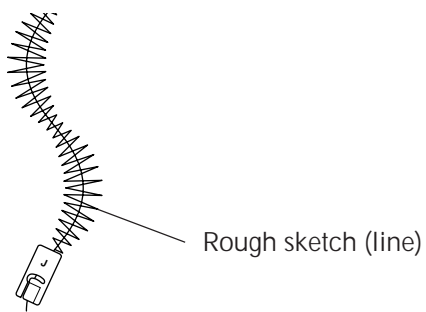

Blind Hem Stitches

Select from these stitches to sew the hems or cuffs of dresses, blouses, pants, or skirts.

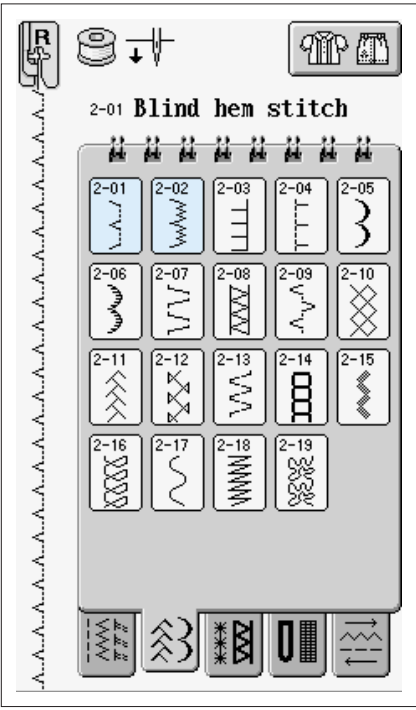

1. Select a stitch pattern.



For woven fabrics



For stretch fabrics (jersey, knit fabrics)

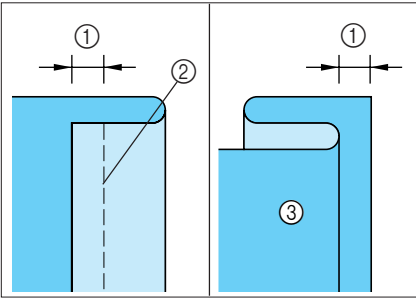

2. Place the fabric wrong side up. Fold and baste the fabric as illustrated.

- ① 5 mm (3/16 inch)
- ② Basting stitches
- ③ Wrong side of the fabric

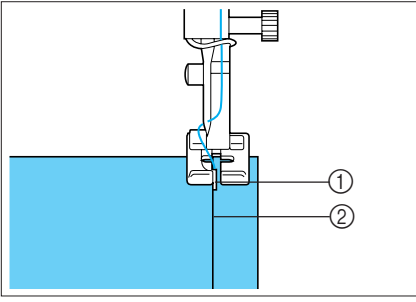

3. Attach blind hem stitch foot "R", and lower the presser foot. Position the fabric so the folded edge touches the guide of the presser foot.

- ① Guide
- ② Fold

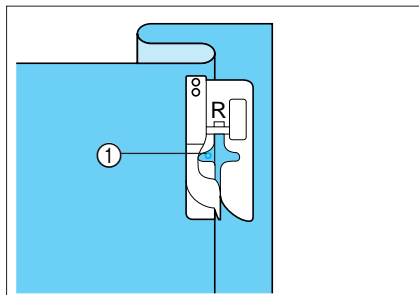

4. Sew the fabric, keeping the folded edge in contact with the presser foot.

① Needle position

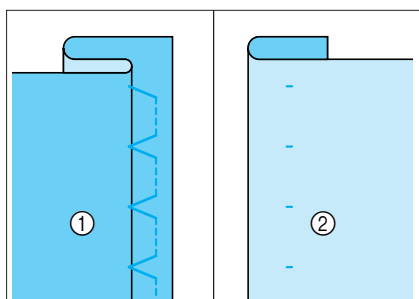

5. Remove the basting stitches and turn over the fabric.

① Wrong side of fabric

② Right side of fabric

Blind hem stitches can not be sewn if the left needle drop point does not catch the fold. If the needle catches too much of the fold, the fabric can not be unfolded and the seam appearing on the right side of the fabric will be very large, leaving an unattractive finish. If you experience either of these cases, follow the instructions below to solve the problem.

■ If the Needle Does not Catch the Fold

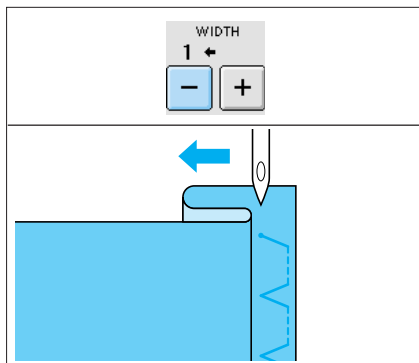

Adjust the width so that the needle slightly catches the fold by pressing **-** in the WIDTH display.

■ If the Needle Catches Too Much of the Fold

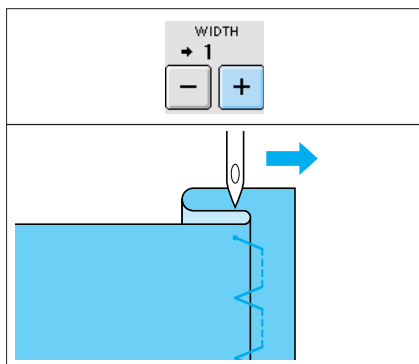

Adjust the width so that the needle slightly catches the fold by pressing **+** in the WIDTH display.

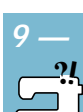

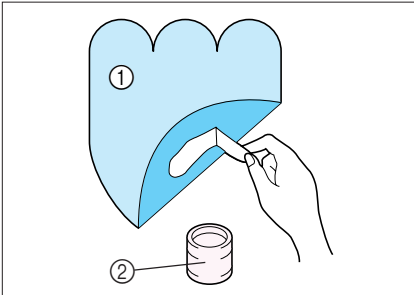

Appliqué

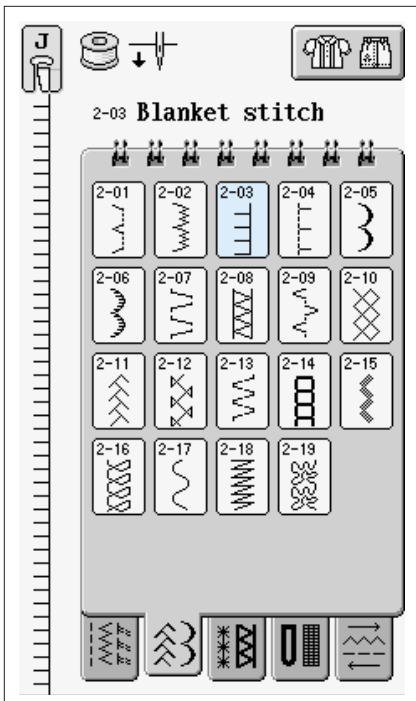

1. Use a temporary spray adhesive, fabric glue or a basting stitch to attach the appliqué to the fabric. This will keep the fabric from moving during sewing.

- ① Appliqué
- ② Fabric glue



2. Select  or .

- * Adjust the stitch length and width to correspond to the appliqué shape, size, and quality of material (see pages 2-8, 2-9).

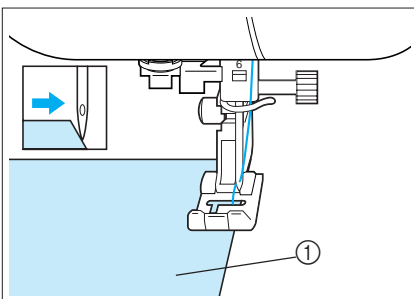

3. Attach presser foot "J". Check that the needle drops slightly off the edge of the appliqué, then begin sewing.

- ① Appliqué material

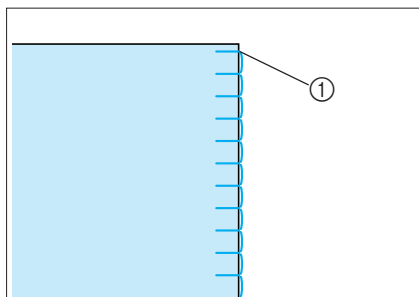

① Needle drop position

■ Sewing Sharp Curves

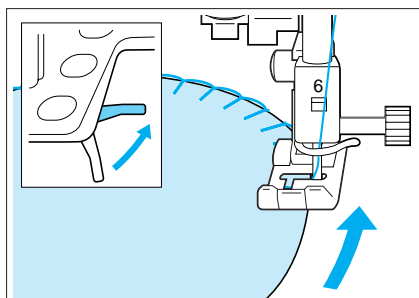

Stop the machine with the needle in the fabric outside the appliqué. Raise the presser foot and turn the fabric a little bit at a time while sewing, for an attractive finish to the seam.

Note

Placing a lightweight tear away stabilizer beneath stitching area will improve the stitch placement along the edge of the appliqué fabric.

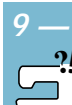

Shelltuck Stitches

Shelltuck stitches give an attractive appearance of shells along the curve of a collar. This stitch pattern can be used for edging the neckline or sleeves of dresses or blouses.

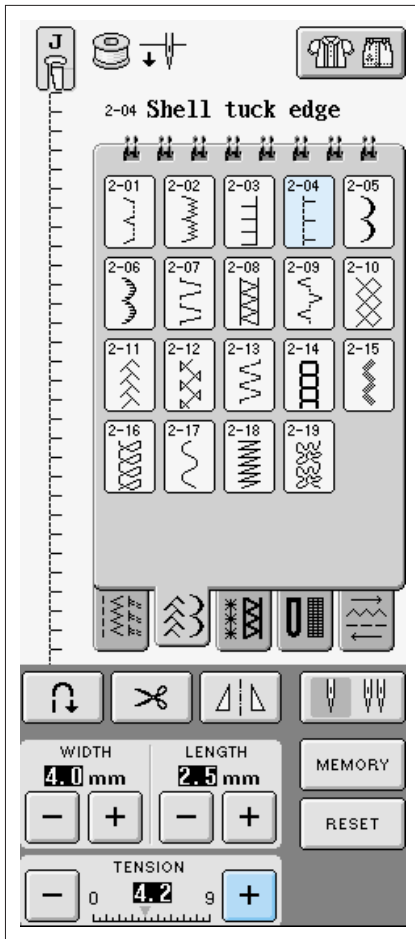

1. Select



2. Increase the upper thread tension for an attractive scallop finish to the shelltuck stitches.

* If the upper thread tension is too weak, the shelltuck stitches will not scallop.

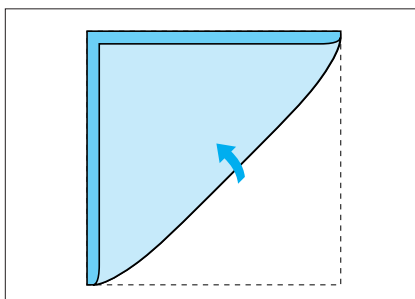

3. To make rows of shell tuck stitches, fold the fabric in half along the bias.

* Use a thin fabric.

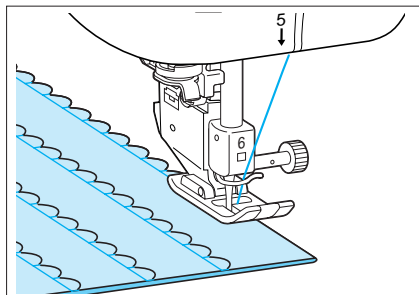

4. Attach presser foot "J". Set the needle drop point slightly off the edge of the fabric, and start sewing.

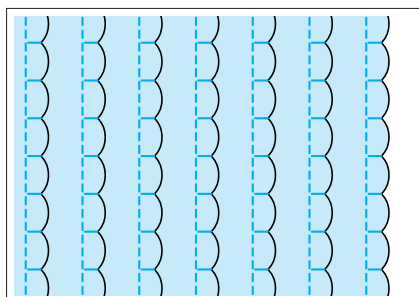
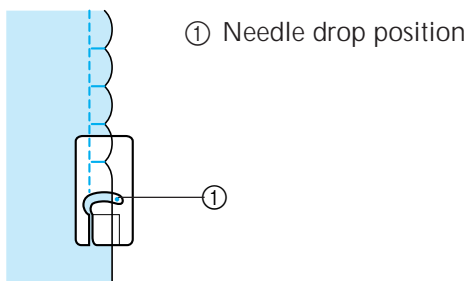

5. Unfold the fabric, and iron the tucks to one side.

Note

To make shell tucks at edge of a collar or neckline follow the pattern's instructions and then use this stitch to make a decorative finish on the collar or neckline.

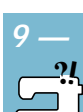

Scallop Stitches

This wave shaped running stitch pattern is called the scallop stitch pattern. Use this stitch pattern to decorate the edges of blouse collars and handkerchiefs or use it as an accent at a hem. A temporary spray adhesive may be necessary for lightweight fabrics. Test sew before sewing on project.

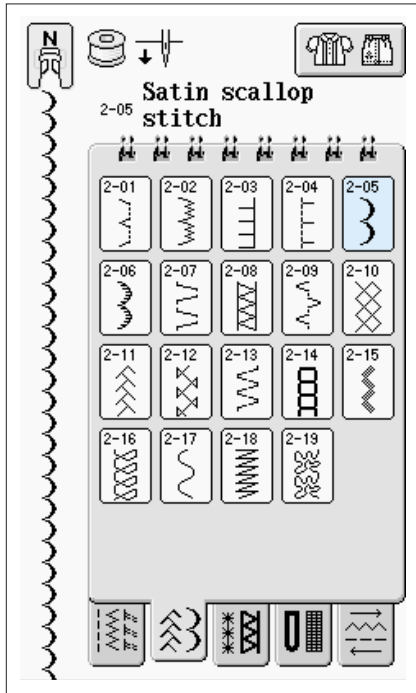

1. Select .

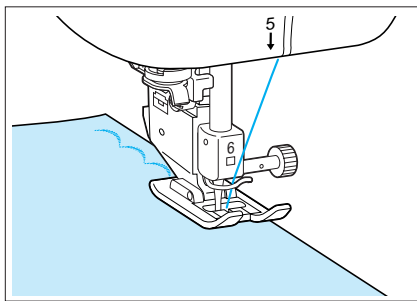

2. Attach presser foot "N". Sew scallop stitches along the edge of the fabric. Do not sew directly on the edge of the fabric.

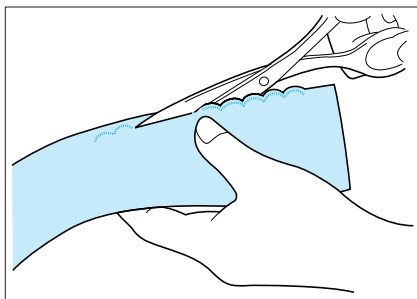



3. Trim along the seam, making sure not to cut the stitches.

Note _____
Use a seam sealant to secure the edges of the scallop stitches.

Patchwork Stitches

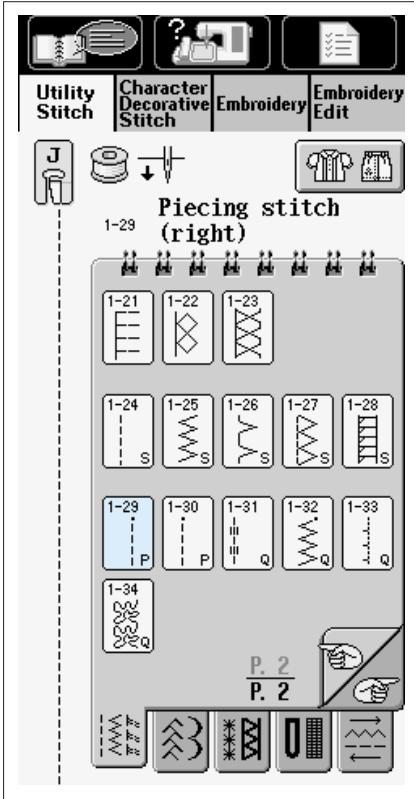
For a decorative look called "Crazy Quilting" the following stitches can be sewn on top of a pressed seam allowance.



1. Select , and attach presser foot "J".

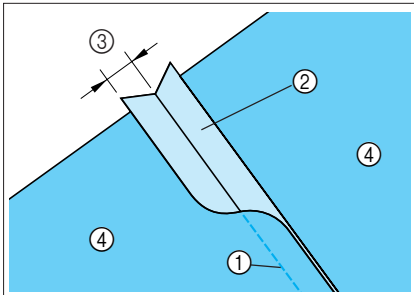

2. Place two pieces of fabric right side together. Sew the fabrics together, then press open the seam allowance.
 - ① Straight stitch
 - ② Seam margins
 - ③ 6.5 mm (1/4 inch)
 - ④ Reverse side



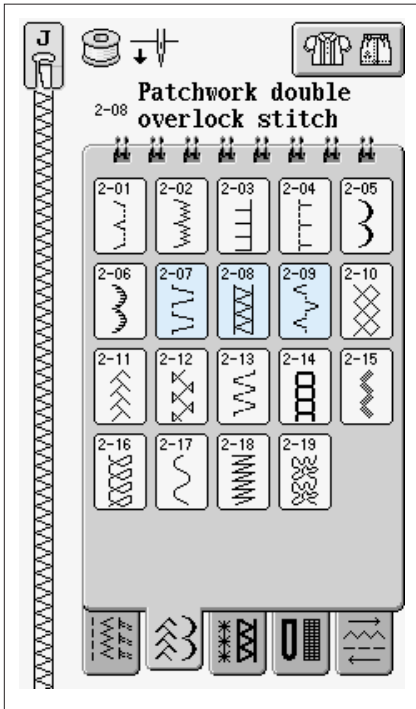

3. Select a stitch pattern.

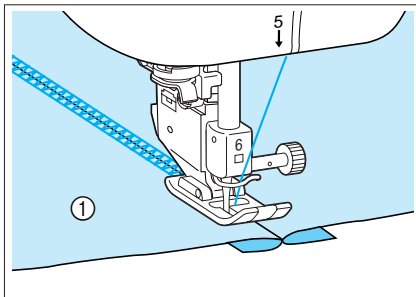

4. Place the fabric right side up in the machine. Center the presser foot over the seam, and sew over the seam.

① Right side of the fabric

Smocking Stitches

Use smocking stitches for decorative sewing on clothes, etc.

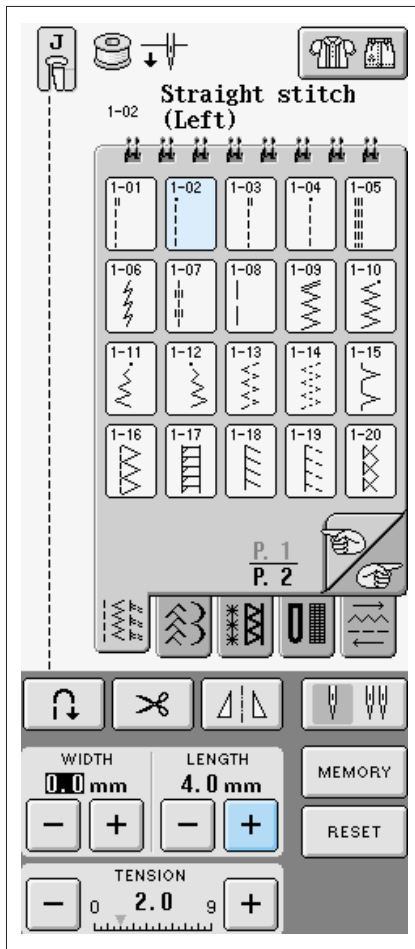

1. Select a straight stitch pattern, and attach presser foot "J".

2. Set the stitch length to 4.0, loosen the upper thread tension, and sew the seams, leaving about 10 mm (3/8 inch) between the seams.

① About 10 mm (3/8 inch)

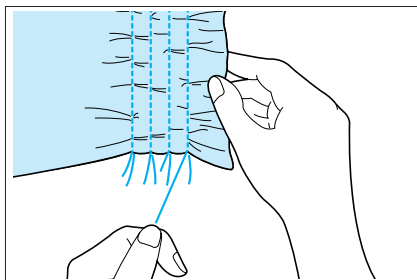
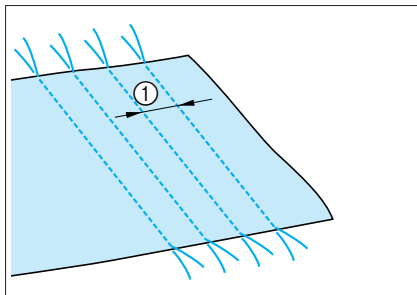

3. Pull the bobbin threads to obtain the desired amount of gather, and then smooth the gathers by ironing them.

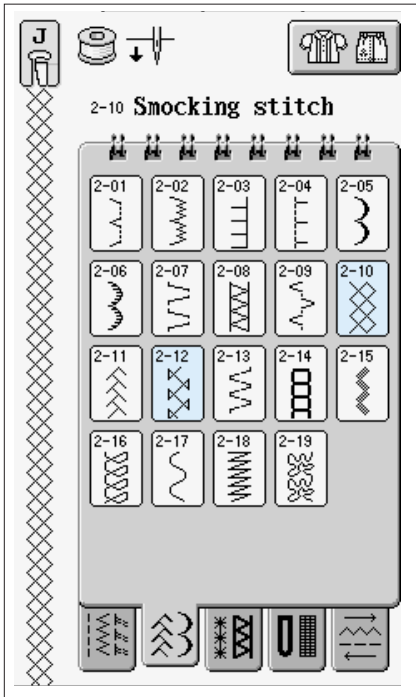

4. Select or .

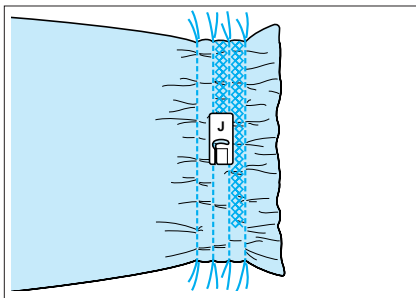

5. Sew the spaces between the straight seams.

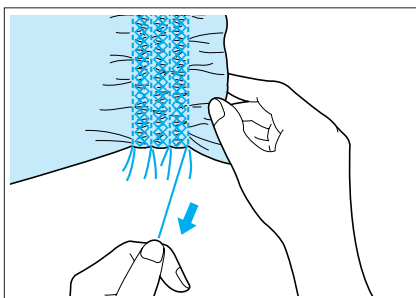

6. Pull out the straight stitch threads.

Fagoting

When there is a space between two fabrics, with thread sewn over the space to join the fabrics together, it is called fagoting. Use this stitch when sewing blouses or children's clothes.

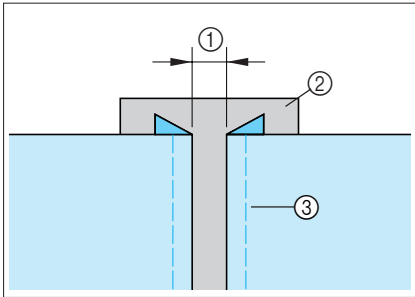

1. Baste two pieces of fabric onto thin paper, leaving a space of 4 mm (3/16 inch) between the fabrics.
 - ① 4 mm (3/16 inch)
 - ② Paper
 - ③ Basting stitches

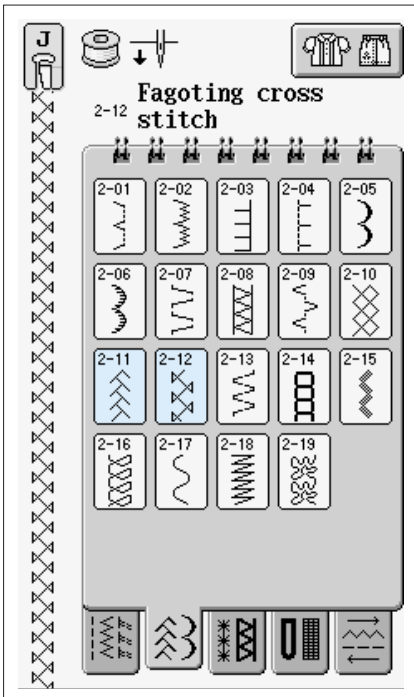

2. Select  or .

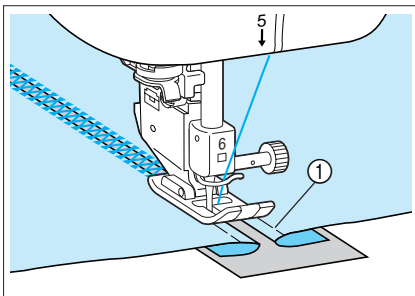

3. Attach presser foot "J". Align the center of the presser foot with the middle of the space between the fabrics and begin sewing. Use a thick thread.
 - ① Basting stitches
4. When sewing is finished, gently tear the paper away.



Tape or Elastic Attaching

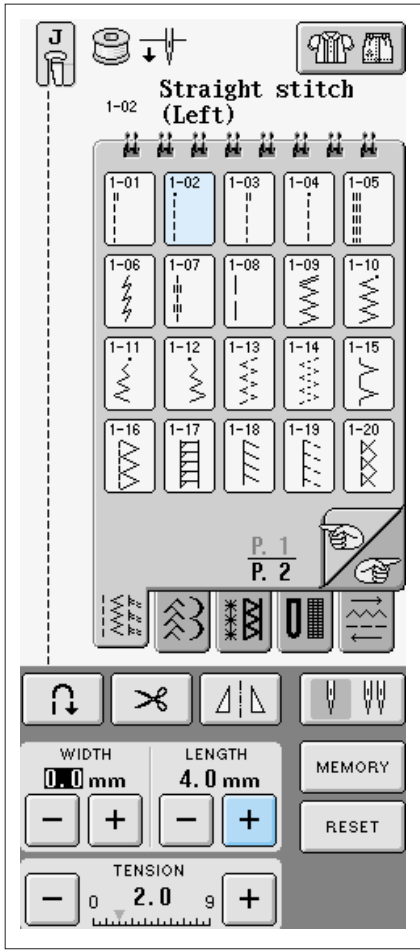

1. Select a straight stitch pattern, and attach presser foot "J".
Set the stitch length to 4.0 mm, and loosen the upper thread tension to 2.0.

Note _____
Be sure that neither the automatic reinforcement nor the automatic thread cutting is selected.

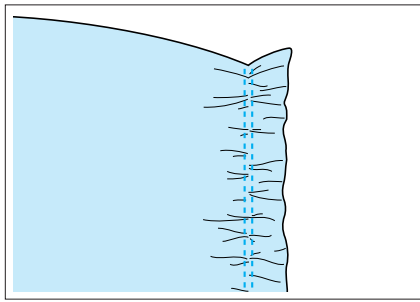

2. Sew 2 rows of straight stitches on the right side of the fabric, then pull the bobbin thread to gain the necessary gather.

Note _____
Before sewing the straight stitch, rotate the balance wheel and pull up the bobbin thread, grasping the top and bobbin thread pull a length of thread out from the rear of the machine. (Be sure that the presser foot is lifted).

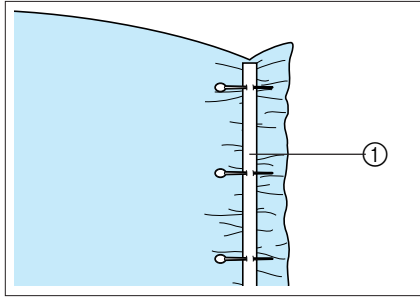

3. Place the tape over the gather, and hold it in place with basting pins.
① Tape

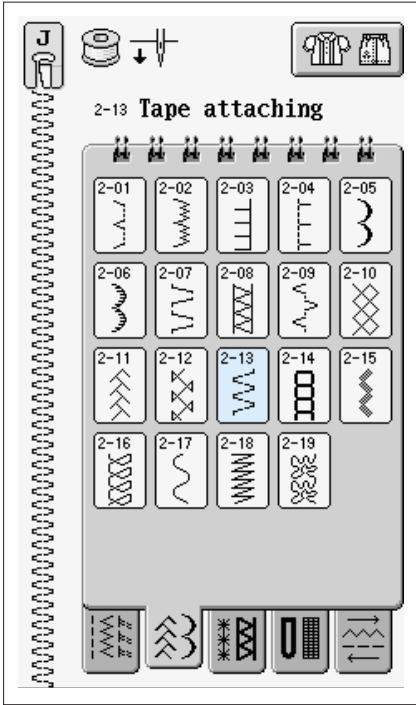

4. Select or .

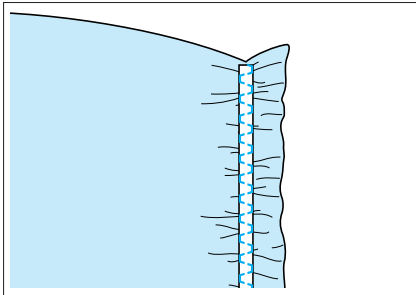

5. Sew over the tape (or elastic).

⚠ CAUTION

Be sure the needle does not strike a basting pin, or any other objects, during sewing. The thread could tangle or the needle could break, causing injury.

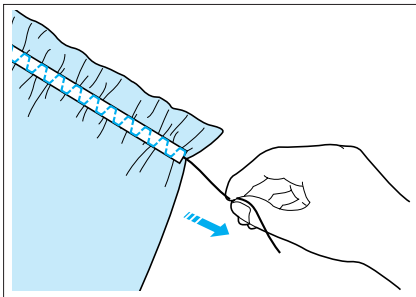

6. Pull out the straight stitch threads.

Heirloom

■ Hemstitching (1) (Daisy stitch)

Use for sewing tablecloths, decorative hems, and decorative stitching on shirt fronts.

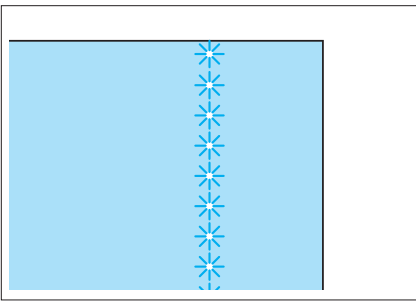
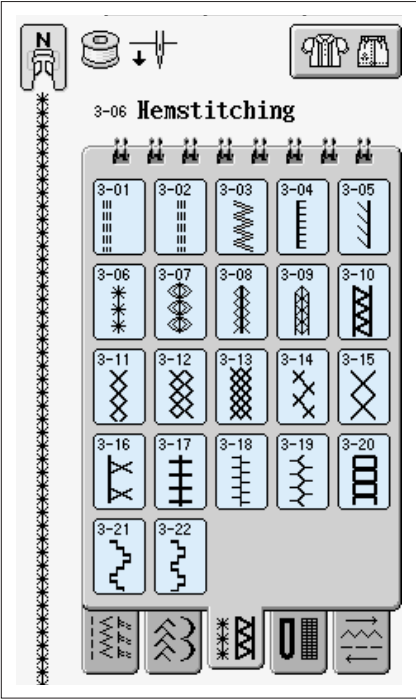

1. Use a light to medium weight homespun fabric with a little stiffness.
2. Insert needle size 130/705H, 100/16 Wing needle.

CAUTION

- The needle threader lever can not be used. Thread the wing needle by hand, from front to back. Using the needle threader lever may result in damage to the machine.
- A more attractive finish can be obtained if you use "130/705H Wing" needle when sewing these patterns. If using a wing needle and the stitch width has been set manually, check that the needle will not touch the presser foot before starting sewing by carefully rotating the balance wheel.

3. Select a stitch pattern, attach presser foot "J", and start sewing.

* Select any pattern between 3-01 and 3-22.

■ Hemstitching (2) (Drawn work)

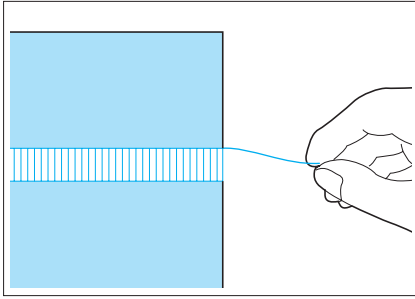

1. Pull out several threads from one area on a piece of fabric to open the area. Pull out 5 or 6 threads to leave a 3 mm (1/8 inch) area open.

Note _____
Loosely woven fabrics work best for this.

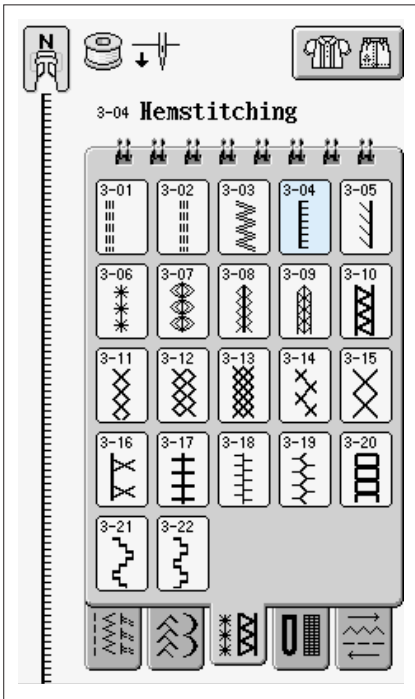

2. Select .

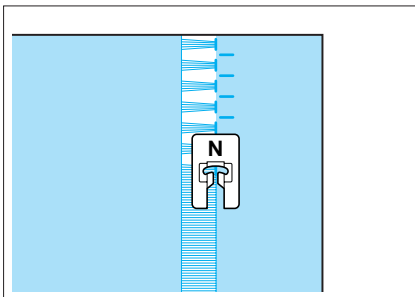

3. Attach presser foot "N". With the right side of the fabric facing up, sew one edge of the open area.



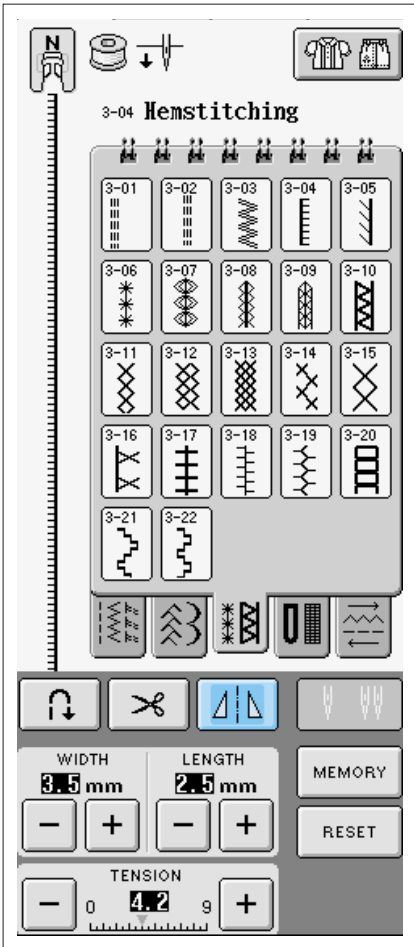

4. Press to create a mirror image of the stitch pattern.

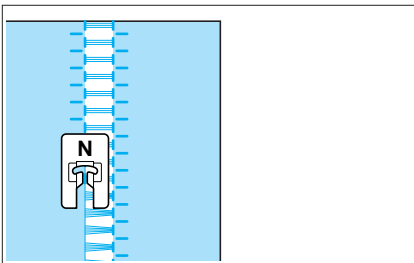

5. Sew the opposite side to keep the pattern symmetrical.

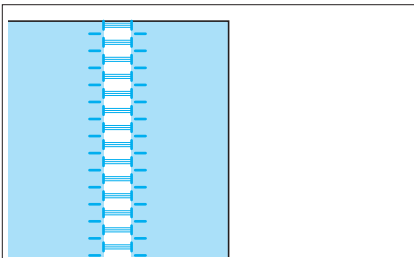

6. Illustration of finished product.

■ Hemstitching (3)

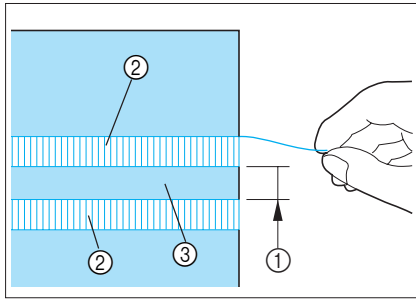

1. Pull out several threads from both sides of the 4 mm (3/16 inch) area which is not yet open. (Pull out four threads, leave five threads and then pull out four threads, the width of five threads is approximately 4 mm (3/16 inch) or less.)

- ① Approx. 4 mm (3/16 inch) or less
- ② Four threads (pull out)
- ③ Five threads (leave)

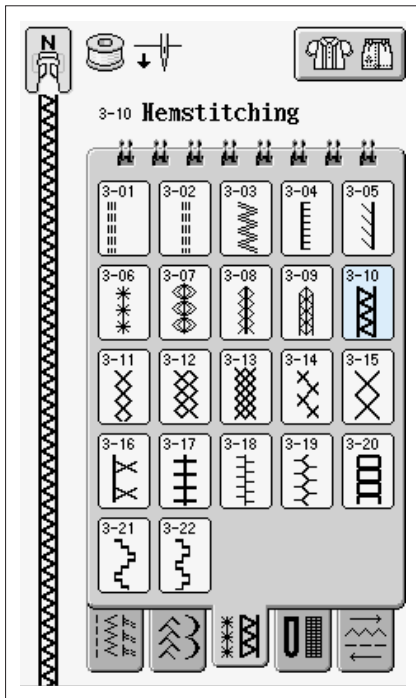

2. Select

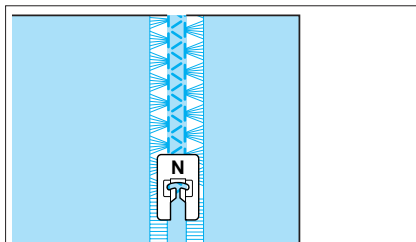

3. Sew the decorative stitch on the center of the five threads created above.

* Using a wing needle is an option.

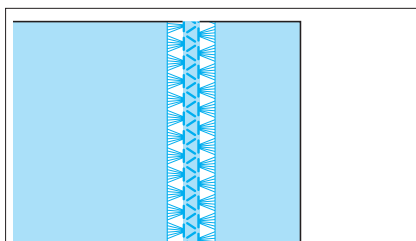

4. Illustration of finished product.

Buttonholes

Buttonholes will sew from the front to back of the buttonhole foot. For best results, place horizontal positioned buttonhole to sew on the garment from the center to the edge of the placket.

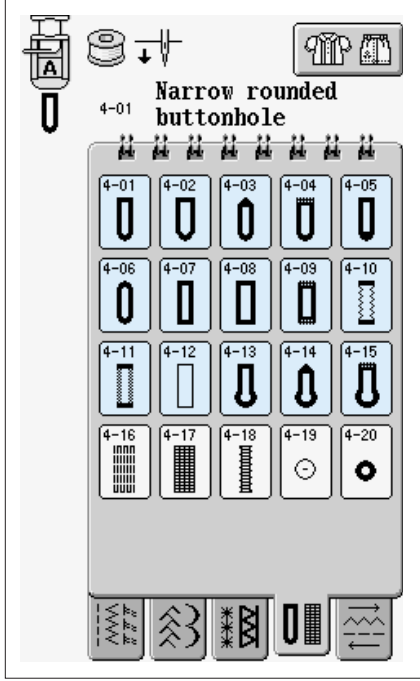

1. Select a stitch pattern, and attach buttonhole foot "A".

4-01 Narrow rounded buttonhole on light to medium weight fabric *2

4-02 Wide round ended buttonhole on medium weight fabric with extra space for larger buttons *2

4-03 Tapered reinforced waist closure buttonhole on medium to heavyweight fabrics*3

4-04 Round ended buttonhole with reinforced bar tack in heavyweight fabrics *3

4-05 Round ended buttonhole with reinforced bar tack in heavyweight fabrics *3

4-06 Round double ended buttonhole for fine medium to heavyweight fabrics *1

4-07 Narrow squared buttonhole for light and medium weight fabrics *1

4-08 Wide squared buttonhole for light to medium weight fabric with extra space for larger decorative buttons*1

4-09 Squared heavy-duty buttonhole with reinforced bar tacks in medium to heavyweight fabrics *3

4-10 Stretch buttonhole with reinforced bar tacks in light to medium weight stretch fabrics, medium to heavyweight tightly woven fabrics, heavyweight fabrics with stretch fabrics *2

4-11 Heirloom buttonhole for light to medium weight stretch fabric. Designed to stretch with and stabilize the base fabric *3

4-12 Bound buttonhole the first step in making bound buttonholes

For tailored and/or decorative front closures

4-13 Keyhole buttonhole in heavyweight fabrics for larger flat buttons *2

4-14 Tapered keyhole buttonhole in medium to heavyweight fabrics for larger flat buttons *2

4-15 Keyhole buttonhole with reinforcement in heavyweight fabrics for larger flat buttons *3

- *1 For use on low stress or decorative applications
- *2 For use on average stress applications
- *3 For use on high stress or utility applications

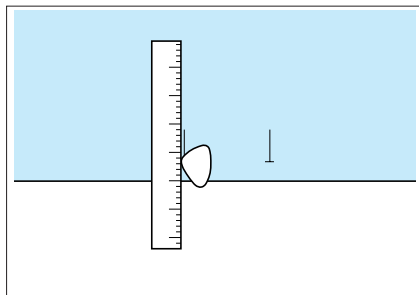

2. Mark the position and length of the buttonhole on the fabric.

Note

The maximum buttonhole length is 30 mm (1-3/16 inch) (diameter + thickness of the button)

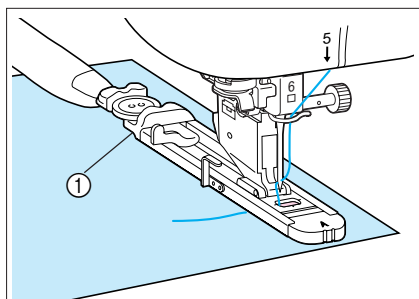

3. Attach buttonhole foot "A". Pull out the button holder plate on the presser foot, and insert the button that will be put through the buttonhole, then tighten the button holder plate around the button.

* The size of the buttonhole is decided by the button holder plate holding the button.

- ① Button holder plate

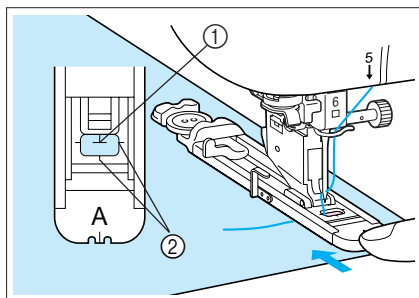

4. Align the presser foot with the mark on the fabric, and lower the presser foot lever.

- ① Mark on the fabric

- ② Mark on the presser foot

CAUTION

- Slide the outside frame of the buttonhole foot backward as far as possible as shown in the illustration, making sure that there is no gap behind the part of the foot marked "A". If the buttonhole foot is not slid back as far as possible, the buttonhole will not be sewn with the correct size.

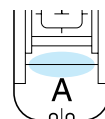

- Pass the thread underneath the presser foot.

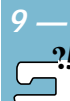

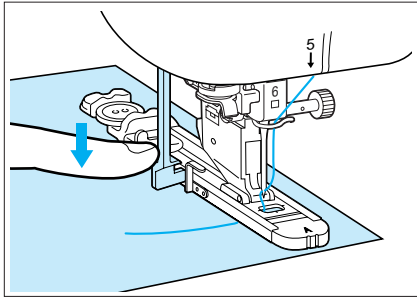

5. Lower the buttonhole lever so that it is positioned behind the metal bracket on the buttonhole foot.

- ① Metal bracket

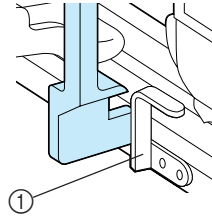

6. Gently hold the end of the upper thread, and then start sewing. Feed the fabric carefully by hand while the buttonhole is sewn. Once sewing is completed, the machine automatically sews reinforcement stitches, and then stops.

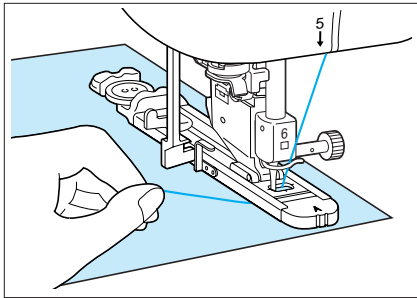

Note

If automatic thread cutting is turned on before you start sewing, both threads are automatically cut after the reinforcement stitches are sewn. If the fabric does not feed (for example, because it is too thick), increase the stitch length setting.

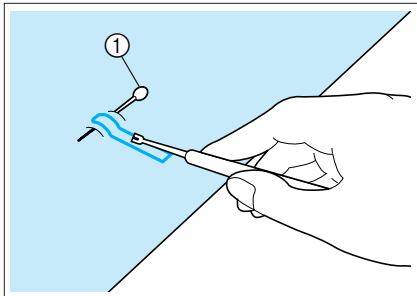

7. Insert a pin along the inside of one of the bar tacks, and then insert the seam ripper into the center of the buttonhole and cut towards the pin.

- ① Basting pin

⚠ CAUTION

When using the seam ripper to open the buttonhole, do not put your hand or finger in the path of the ripper. The ripper may slip and cause injury.

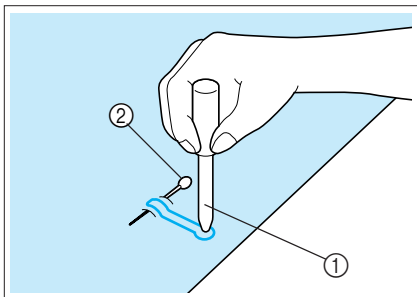

For Keyhole Buttonholes:

Use the eyelet punch to make a hole in the rounded end of the buttonhole. Then insert a pin along the inside of one of the bar tacks, insert a seam ripper into the hole made with the eyelet punch, and cut towards the pin.

- ① Eyelet punch
- ② Basting pin

■ Sewing Stretch Fabrics

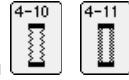
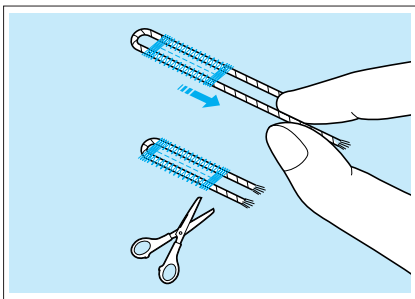
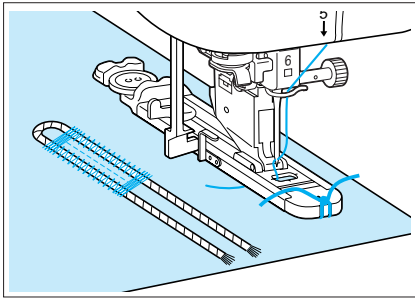
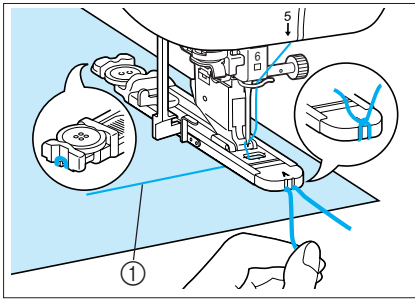

When sewing on stretch fabric with  , sew the buttonhole stitches over a gimp thread.

1. Hook the gimp thread onto the back of presser foot "A". Insert the ends into the grooves at the front of the presser foot, and then temporarily tie it there.

① Upper thread

2. Lower the presser foot lever and start sewing.

Note

Set the stitch width to the width of the gimp thread.

3. Once sewing is completed, gently pull the gimp thread to remove any slack, and trim off any excess.

Note

After using the seam ripper to cut open the threads over the buttonhole, trim off the threads.

■ Odd Shaped Buttons/Buttons that do not Fit into the Button Holder Plate

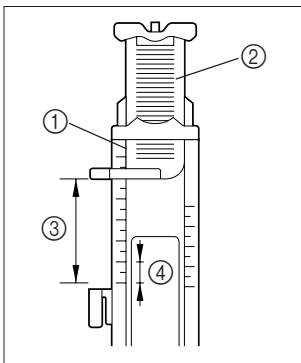

Use the markings on the presser foot scale to set the size of the buttonhole. One mark on the presser foot scale equals 5 mm (3/16 inch).

Add together the button diameter and its thickness, and then set the plate at the calculated value.

① Presser foot scale

② Button holder plate

③ Completed measurement of diameter + thickness

④ 5 mm (3/16 inch)

Example: For a button with a diameter of 15 mm (9/16 inch), a thickness of 10 mm (3/8 inch), the scale should be set at 25 mm (1 inch).

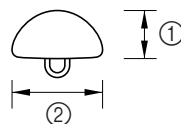

① 10 mm (3/8 inch)

② 15 mm (9/16 inch)



Darning

Use this stitch pattern for mending and other applications.

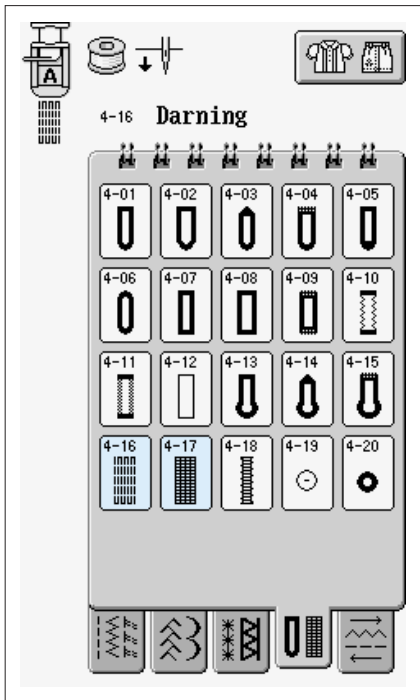

1. Select a stitch pattern.
 - For medium weight fabrics
 - For heavyweight fabrics

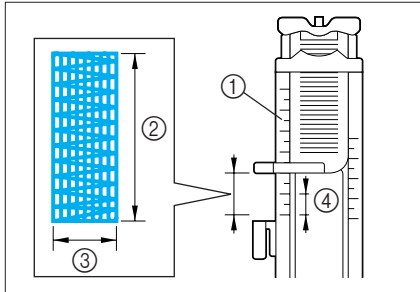

2. Attach buttonhole foot "A" and set the scale to the desired length of the darning.

Note _____
The maximum length of darning is 30 mm (1-3/16 inch).

- ① Presser foot scale
- ② Completed measurement
- ③ Width 7 mm (1/4 inch)
- ④ 5 mm (3/16 inch)

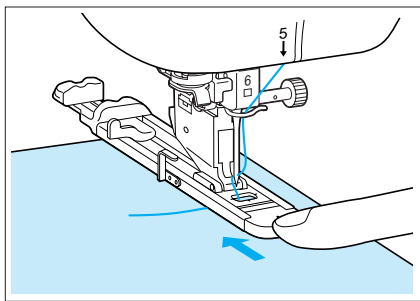

3. Check that the needle drops at the desired position and lower the presser foot lever, making sure the upper thread passes underneath the buttonhole foot.

CAUTION

- Set the presser foot so that there is no gap behind the section marked with an "A" (in the shaded area in the illustration to the right). If there is a gap, the size of the darning will not be correct.
- Pass the thread underneath the presser foot.

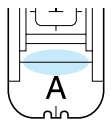

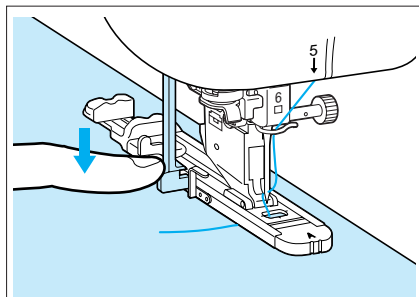

4. Lower the buttonhole lever so that it is positioned behind the metal bracket on the buttonhole foot.

① Metal bracket

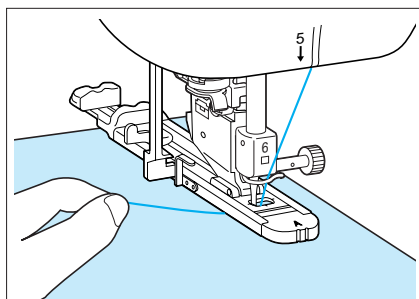
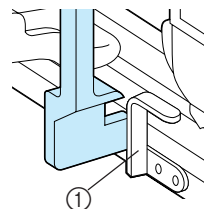

5. Gently hold the end of the upper thread, and then press the "Start/Stop" button to start the machine. Once sewing is completed, the machine automatically sews reinforcement stitches, and then stops.

Note

If automatic thread cutting is turned on before you start sewing, both threads are automatically cut after the reinforcement stitches are sewn. If the fabric does not feed (for example, because it is too thick), increase the stitch length setting.

Darning Stitch Cycle

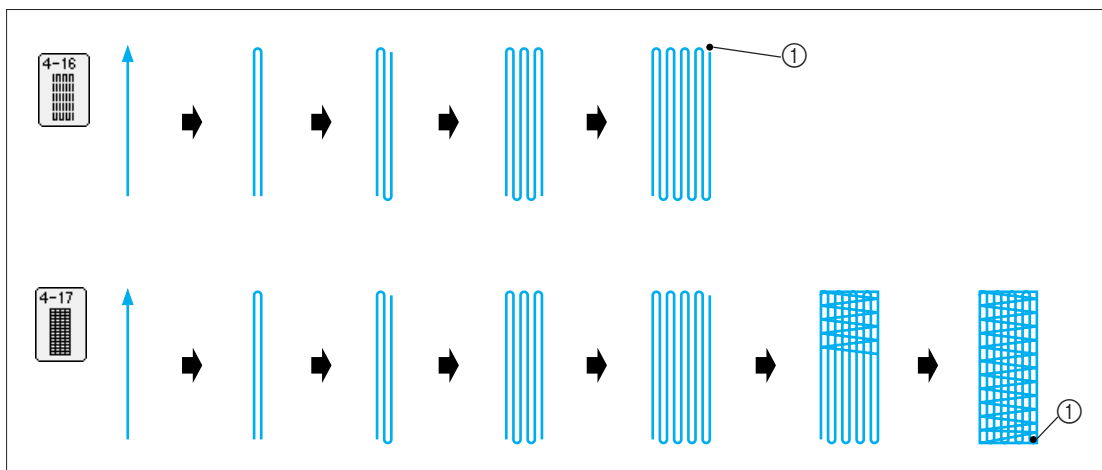

① Cycle of reinforcement stitches

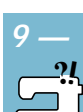

Bar Tacks

Use bar tacks to reinforce areas that will be subject to strain, such as pocket corners.

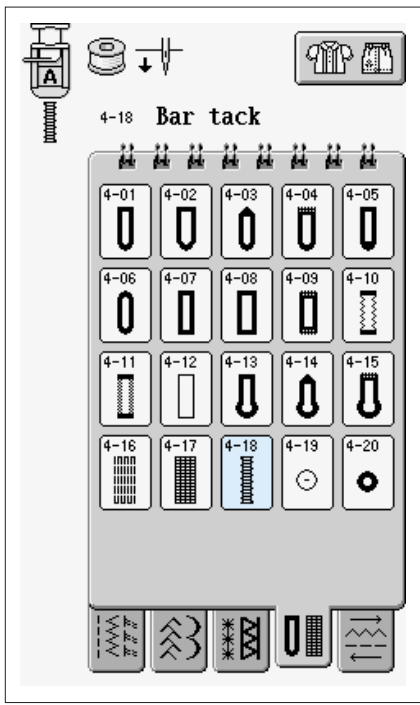

1. Select

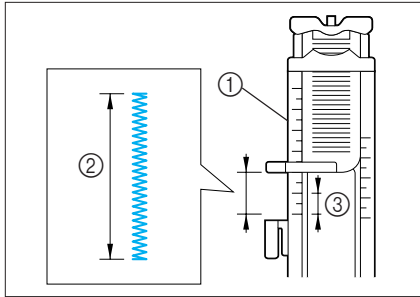

2. Attach buttonhole foot "A" and set the scale to the length of the bar tack you wish to sew.

Note
 Bar tacks can be between 5 mm (3/16 inch) and 30 mm (1-3/16 inch). Bar tacks are usually between 5 mm (3/16 inch) and 10 mm (3/8 inch).

- ① Presser foot scale
- ② Completed measurement
- ③ 5 mm (3/16 inch)

CAUTION
 Be sure the thread passes under the presser foot.

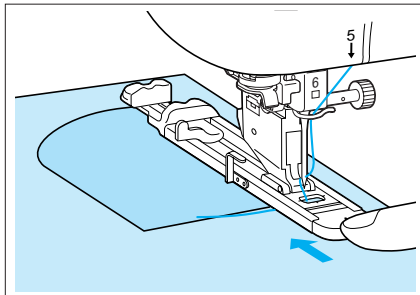

3. Set the fabric so that the pocket moves towards you during sewing.

- CAUTION**
- Slide the outside frame of the buttonhole foot back-ward as far as possible as shown in the illustration, making sure that there is no gap behind the part of the foot marked "A". If the buttonhole foot is not slid back as far as possible, the bar tack will not be sewn to the correct size.
 - Pass the thread underneath the presser foot.

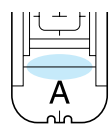

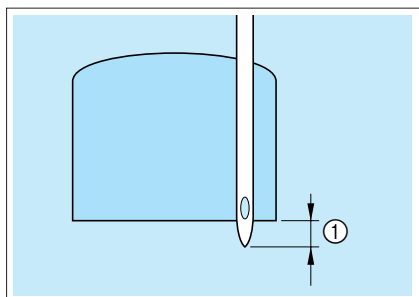

4. Check the first needle drop point and lower the presser foot.

- ① 2 mm (1/16 inch)

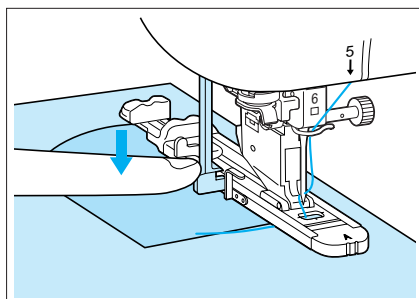

5. Lower the buttonhole lever so that it is positioned behind the metal bracket on the buttonhole foot.

- ① Metal bracket

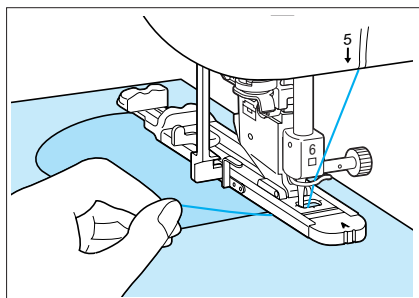
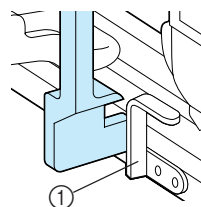

6. Gently hold the end of the upper thread and begin sewing. When sewing is completed, the machine will sew reinforcement stitches and stop automatically.

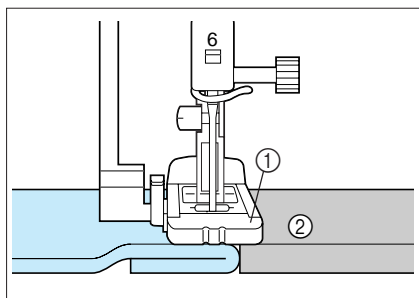

Bar Tacks on Thick Fabrics

Place a piece of folded fabric or cardboard beside the fabric being sewn to level off the buttonhole foot and allow for easier feeding.

Note

If automatic thread cutting is turned on before you start sewing, both threads are automatically cut after the reinforcement stitches are sewn. If the fabric does not feed (for example, because it is too thick), increase the stitch length setting.

- ① Presser foot
- ② Thick paper



Button Sewing

CAUTION

Do not use the automatic thread cutting function when sewing buttons. Otherwise, you will lose the thread ends.

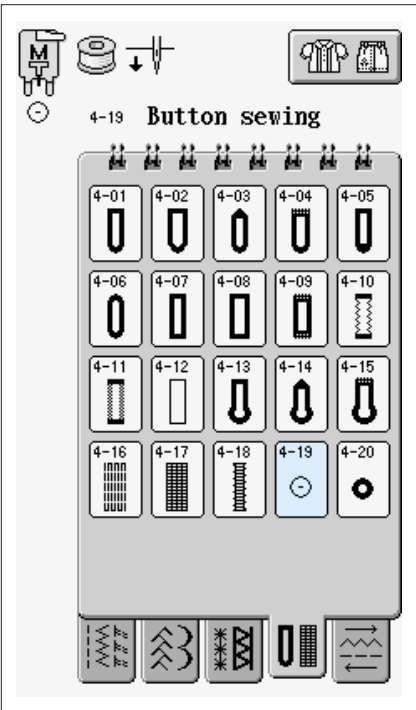

1. Select .

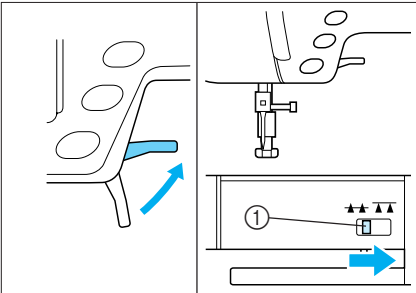

2. Raise the presser foot lever and detach the flat bed table attachment. Move the feed dog position switch to the right to lower the feed dogs.
 ① Feed dog position switch

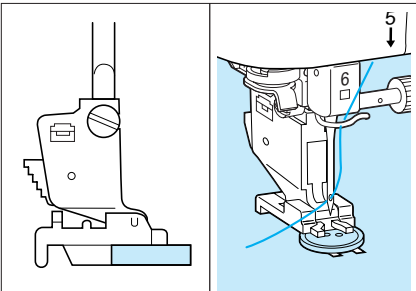

3. Attach button sewing foot "M", place the button in the presser foot, and lower the presser foot lever.

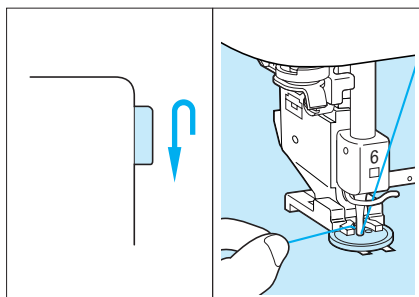

- Turn the balance wheel to check that the needle goes into each hole correctly. Then, gently hold the end of the upper thread and start sewing. The machine stops automatically when sewing is finished.

CAUTION

Make sure the needle does not strike the button during sewing. The needle may break, leading to injury.

Note

- To attach the button more securely, repeat the process.
- If the needle does not reach the holes on the left side, adjust the stitch width.

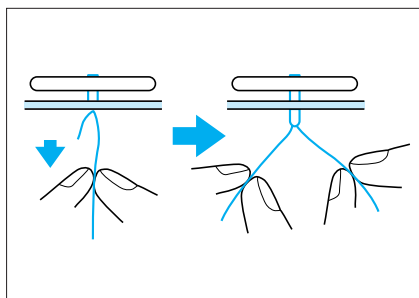

- From the wrong side of the fabric, pull the end of the bobbin thread to pull the upper thread through to the wrong side of the fabric. Tie the two thread ends together and cut the threads.

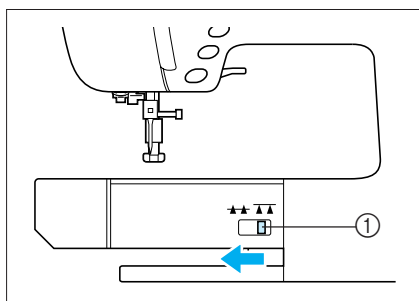

- When sewing is completed, be sure to return the feed dog position switch to its original position.
 - Feed dog position switch

Attaching 4 Hole Buttons

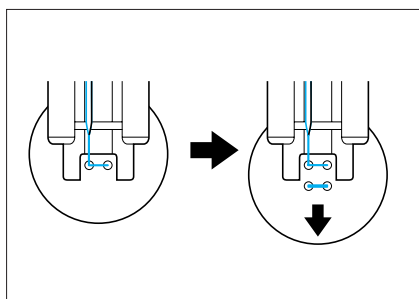

Sew the two holes closest to you. Then raise the presser foot lever and move the fabric so that the needle goes into the next two holes, and sew them in the same way.



■ Attaching a Shank to the Button

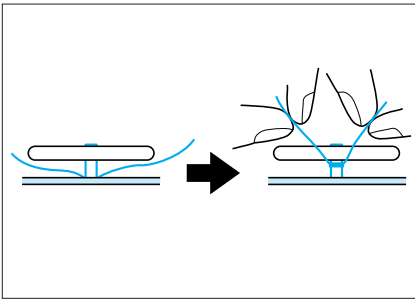
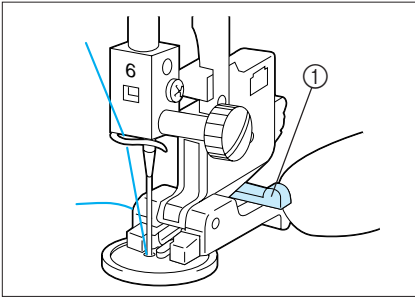

1. Pull the shank lever toward you before sewing.
① Shank lever

2. Pull the two ends of the upper thread between the button and the fabric, wind them around the shank, and then tie them firmly together.
3. Tie the ends of the bobbin thread from the beginning and end of sewing together on the wrong side of the fabric.

Eyelet

Use this stitch pattern for making belt holes and other similar applications.

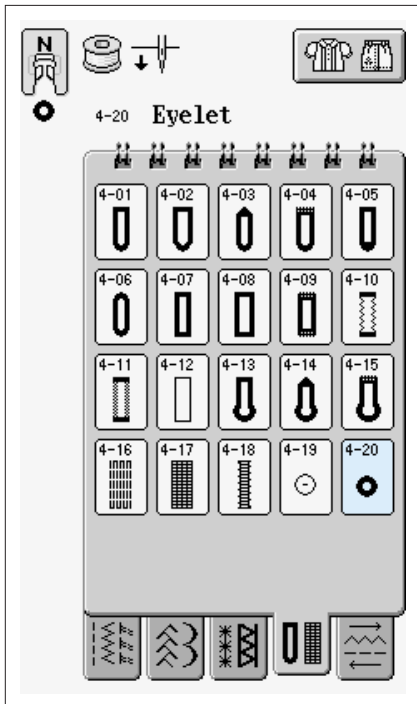

1. Select

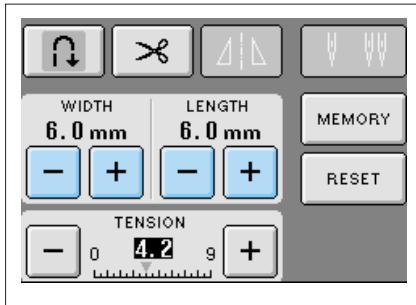

2. Use **-** **+** in either the stitch width display or the stitch length display to choose the size of the eyelet.
 Large 7 mm (1/4 inch), Medium 6 mm (15/64 inch),
 Small 5 mm (3/16 inch) actual size.

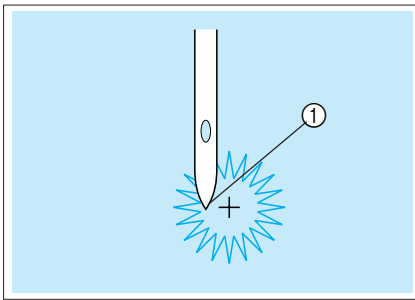
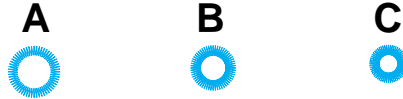

3. Attach monogramming foot "N", then turn the balance wheel to check the needle drop position. Lower the presser foot lever and start sewing. When sewing is finished, the machine sews reinforcement stitches and stops automatically.

① Needle drop position

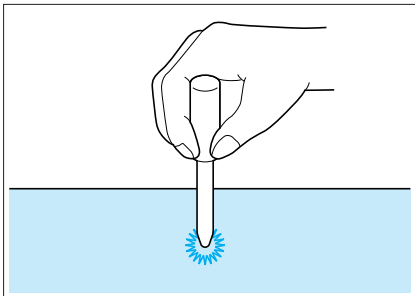

4. Use the eyelet punch to make a hole in the center of the stitching.



Multi-directional Sewing (Straight Stitch and Zigzag Stitch)

To attach patches or emblems to pant legs, shirt sleeves, etc.

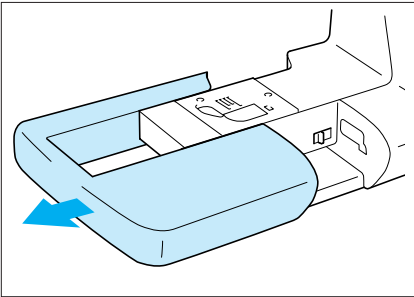

1. Remove the flat bed attachment to create the free arm function.

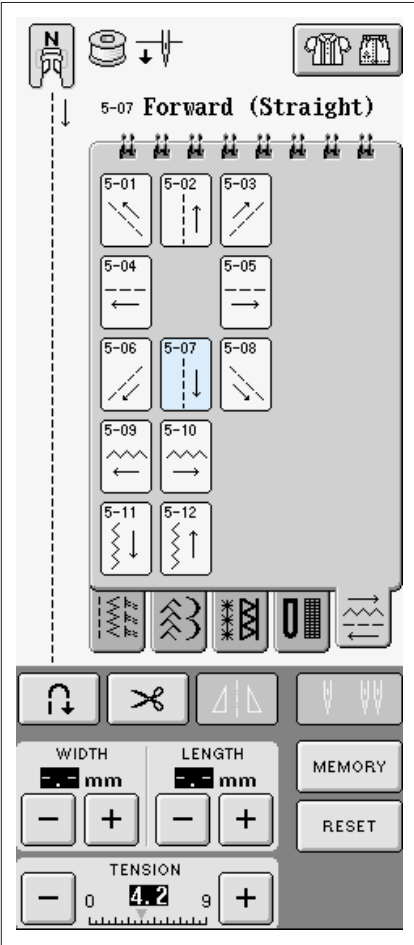
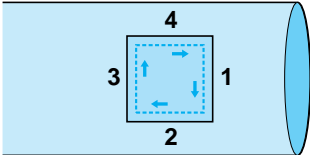

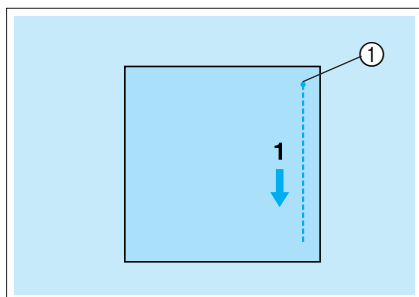

2. Select , and attach monogramming foot "N".

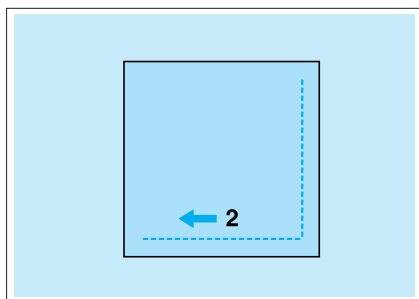

3. Set the needle in the fabric at the sewing start point, and sew seam "1" as shown.

① Start Point



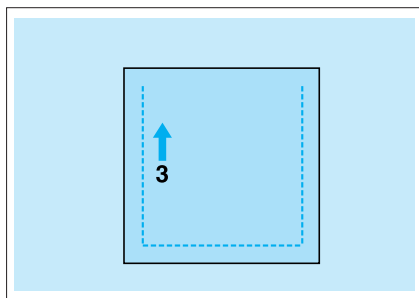

4. Select  and sew seam "2" as shown.

* The fabric will move sideways, so guide the fabric by hand to keep sewing straight.

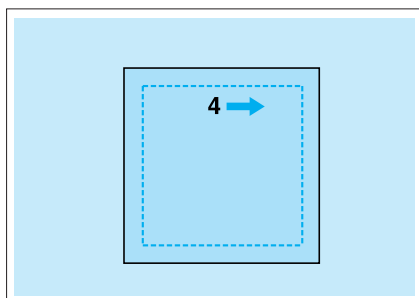

5. Select  and sew seam "3" as shown. The fabric feeds forward while stitching backward.



6. Select  and sew seam "4" as shown, connecting the seam to the starting point of seam 1.

Note

Follow the same steps for multi-directional sewing with zigzag stitches.

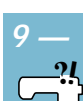



Zipper Insertion

Centered Zipper

Use for bags and other such applications.

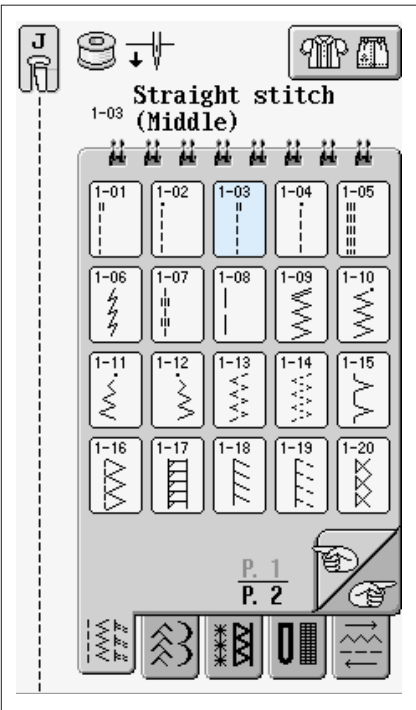

1. Select 

CAUTION
Make sure you sew using the middle needle position.

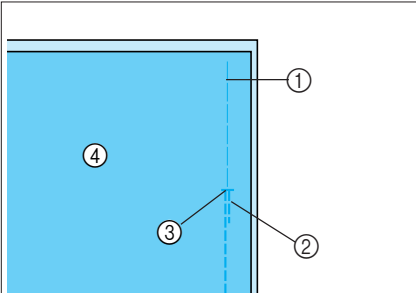

2. Attach presser foot "J" and sew straight stitches up to the zipper opening. Change to a basting stitch and sew to the top of the fabric.

- ① Basting stitches
- ② Reverse stitches
- ③ End of zipper opening
- ④ Reverse side

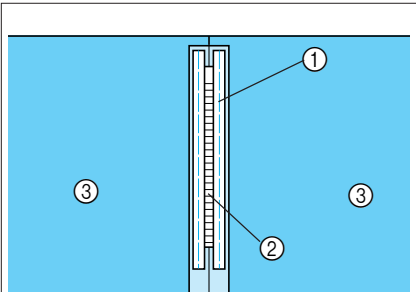

3. Press the seam allowance open and attach the zipper with a basting stitch in the middle.

- ① Basting stitches
- ② Zipper
- ③ Reverse side

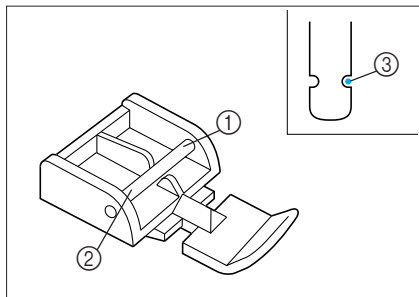

4. Remove presser foot "J". Align the right side of the pin in zipper foot "I" with the presser foot holder, and attach the zipper foot.

- ① Right
- ② Left
- ③ Needle drop position

CAUTION

When using zipper foot "I", make sure the straight stitch, middle needle position is selected. Turn the balance wheel to make sure the needle does not strike the presser foot. If another stitch is selected, the needle will strike the presser foot, causing the needle to break and possible leading to injury.

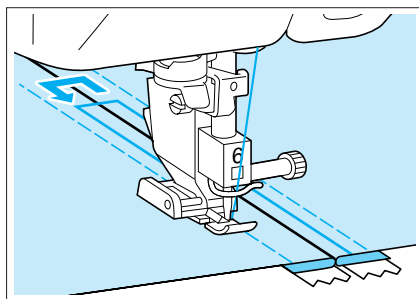

5. Topstitch 7 to 10 mm (1/4 to 3/8 inch) from the seamed edge of the fabric, then remove the basting.

CAUTION

Make sure the needle does not strike the zipper during sewing. If the needle strikes the zipper, the needle may break, leading to injury.

Inserting a Side Zipper

Use for side zippers in skirts or dresses.

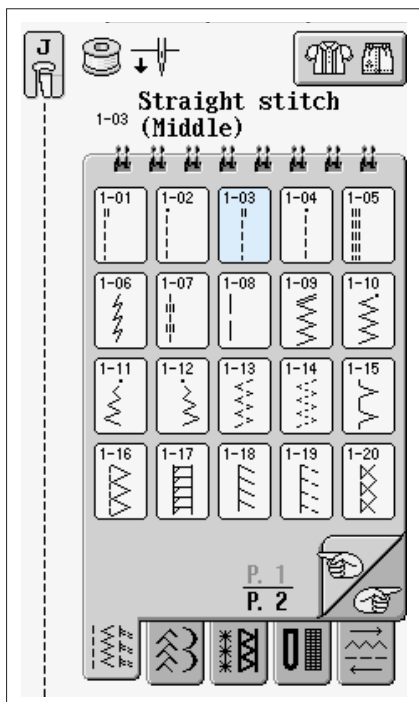

1. Select

CAUTION

Make sure you sew using the middle needle position.



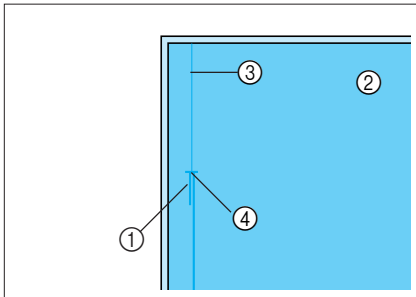

2. Attach presser foot "J" and sew straight stitches up to the zipper opening. Change to a basting stitch and sew to the top of the fabric.

- ① Reverse stitches
- ② Wrong side of fabric
- ③ Basting stitches
- ④ End of zipper opening

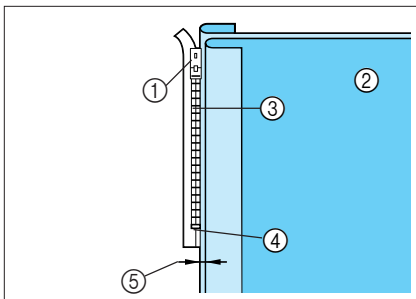

3. Press the seam allowance open and align the folded hem along the teeth of the zipper, while maintaining 3 mm (1/8 inch) for the sewing space.

- ① Zipper pull tab
- ② Wrong side of fabric
- ③ Zipper teeth
- ④ End of zipper opening
- ⑤ 3 mm (1/8 inch)

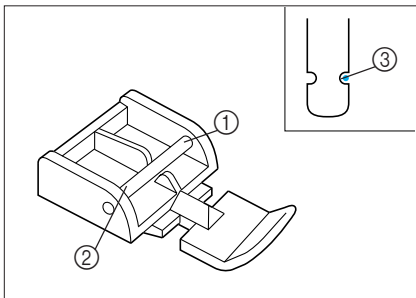

4. Remove presser foot "J". Align the right side of the pin in zipper foot "I" with the presser foot holder, and attach the presser foot.

- ① Right
- ② Left
- ③ Needle drop position

⚠ CAUTION

When using zipper foot "I", make sure the straight stitch, middle needle position is selected. Turn the balance wheel to make sure the needle does not strike the presser foot. If another stitch is selected, the needle will strike the presser foot, causing the needle to break and possible leading to injury.

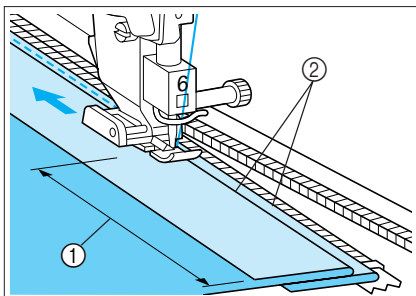

5. Set the presser foot in the 3 mm (1/8 inch) margin. Starting from the end of the zipper opening. Sew to a point about 50 mm (2 inch) from the edge of the fabric, then stop the machine. Pull down the zipper slider, then continue sewing to the edge of the fabric.

- ① 50 mm (2 inch)
- ② 3 mm (1/8 inch)

⚠ CAUTION

Make sure the needle does not strike the zipper during sewing. If the needle strikes the zipper, the needle may break, leading to injury.

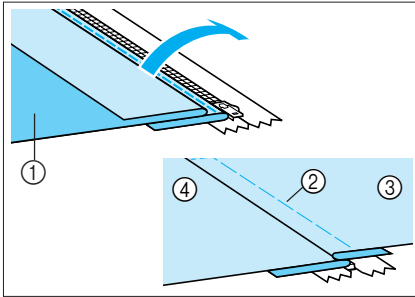

6. Close the zipper, turn the fabric over, and sew a basting stitch.

- ① Front of the skirt (wrong side of fabric)
- ② Basting stitches
- ③ Front of the skirt (right side of fabric)
- ④ Back of the skirt (right side of fabric)

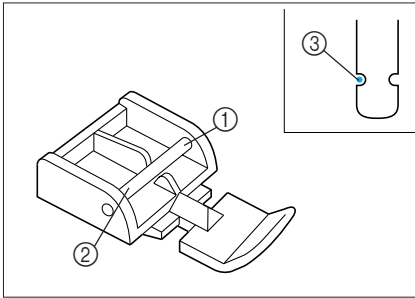

7. Remove the presser foot, and reattach it so that the left side of the pin is attached to the presser foot holder.

* When sewing the left side of the zipper, the needle should drop on the right side of the presser foot. When sewing the right side of the zipper, the needle should drop on the left side of the presser foot.

- ① Right
- ② Left
- ③ Needle drop position

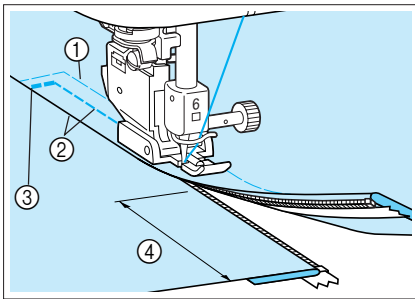

8. Set the fabric so that the left edge of the presser foot touches the edge of the zipper teeth. Sew reverse stitches at the top of the zipper, then continue sewing. Stop sewing about 50 mm (2 inch) from the edge of the fabric, leave the needle in the fabric, and remove the basting stitches. Open the zipper and sew the rest of the seam.

- ① Basting stitches
- ② 7 to 10 mm (1/4 inch to 3/8 inch)
- ③ Reverse stitches
- ④ 50 mm (2 inch)



Chapter 4 Sewing Character/Decorative Stitches

SELECTING A STITCH PATTERN

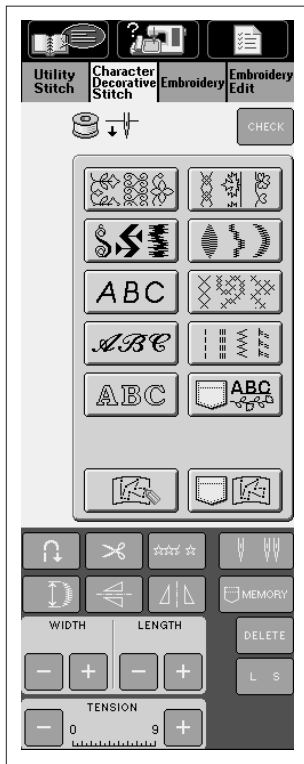



1. Press **Character Decorative Stitch** to display the screen as left.
2. Press the key of the type of pattern you want to sew to select that category.

	Decorative stitch patterns
	Satin stitch
	Alphabetical characters (Gothic Font)
	Alphabetical characters (handwriting font)
	Alphabetical characters (outline)
	7mm decorative stitch. You can set stitch length and width.
	7mm satin stitch. You can set stitch length and width.
	Cross stitch
	Utility decorative stitch Stitch width is less than 7 mm for these patterns. You can set stitch length and width.
	Retrieving saved stitch patterns (see page- 4-31)
	Retrieving "MY CUSTOM STITCH™". Create your own stitches with this function (see page 7-3).
	Retrieving saved "MY CUSTOM STITCH™" patterns (see page 7-13).

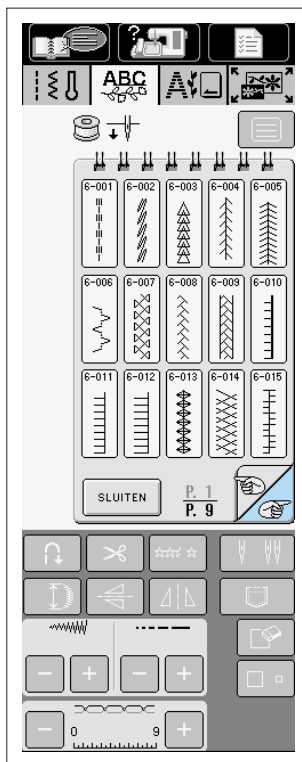
Decorative Stitch Patterns



1. Press **Character Decorative Stitch**, then press  to display the screen at left.

2. Press  to view the next screen.

Press  to view the previous screen.

There are a total of 9 selection screens.

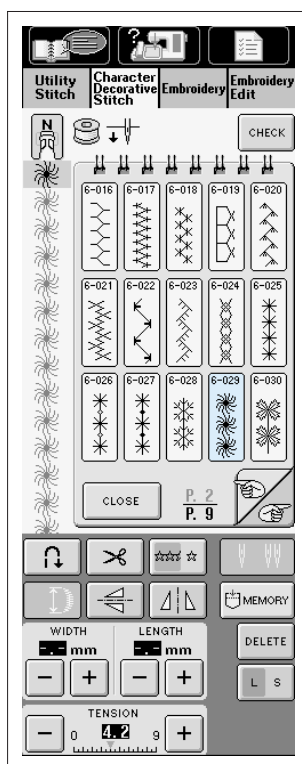

3. Press the key of the stitch pattern you want to sew.

To select a different stitch pattern, press **DELETE**. When the current stitch pattern is erased, select the new stitch pattern.

7mm Decorative Stitch Patterns

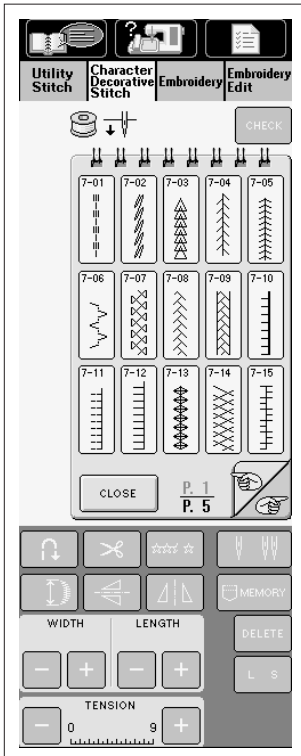

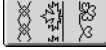
1. Press **Character Decorative Stitch** then press  to display the screen at left.
2. The stitch pattern selection method is the same as for decorative stitch patterns.

Satin Stitch Patterns

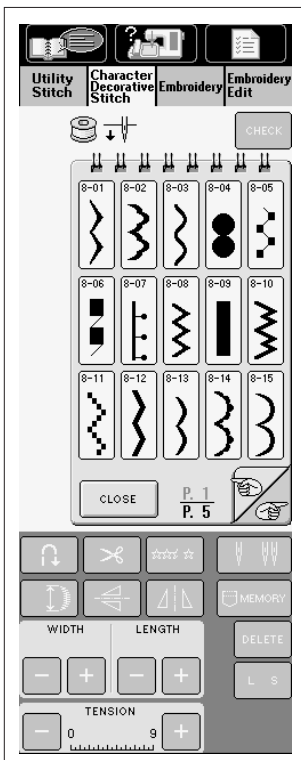

1. Press **Character Decorative Stitch** then press  to display the screen at left.
2. The stitch pattern selection method is the same as for decorative stitch patterns.

7mm Satin Stitch Patterns

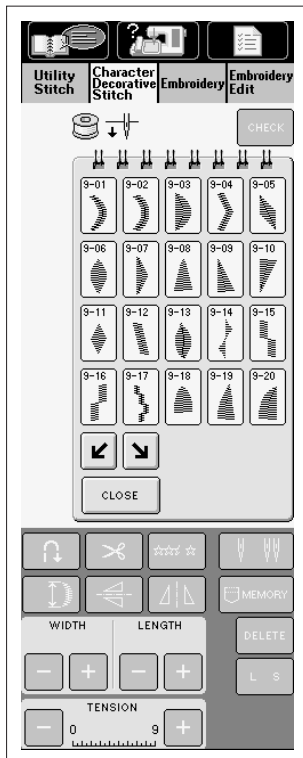

1. Press **Character Decorative Stitch** then press  to display the screen at left.
2. The stitch pattern selection method is the same as for decorative stitch patterns.



Cross Stitch

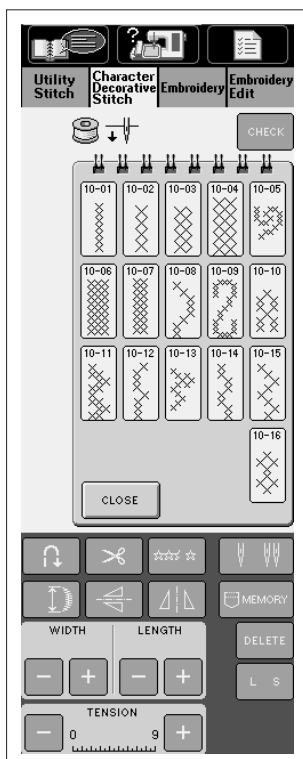

1. Press **Character Decorative Stitch** then press  to display the screen at left.
2. The stitch pattern selection method is the same as for decorative stitch patterns.



Utility Decorative Stitch Patterns

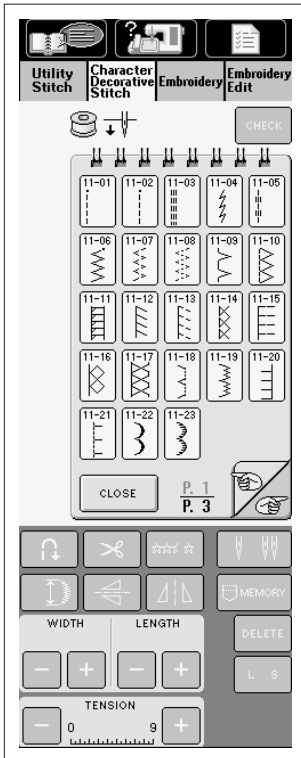

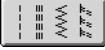
1. Press **Character Decorative Stitch** then press  to display the screen at left.
2. The stitch pattern selection method is the same as for decorative stitch patterns.

Alphabetical Characters

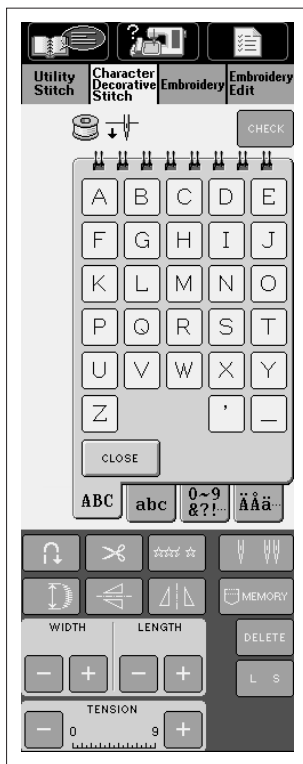

There are three types of fonts for alphabetical character stitches. The selection process is the same for all three fonts. We are using the Gothic font in the example below.

1. Press **Character Decorative Stitch** then press **ABC** to display the screen at left.
2. Press **ABC** **abc** **0~9 &?!...** **ÄÄä...** to change the selection screen.
3. Press the keys to select the letters you want to sew.

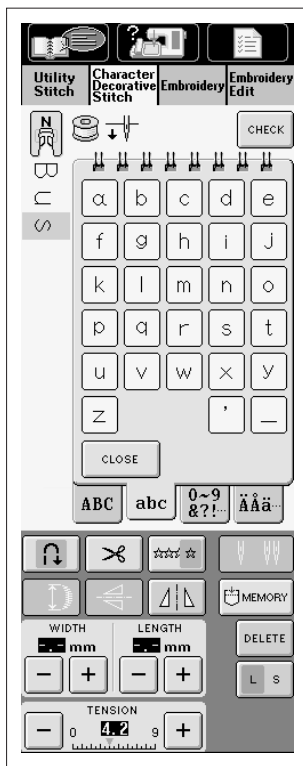

Example: Enter the word "Bus"

1. Press **B**.
2. Press **abc**.
3. Press **u**.
4. Press **s**.

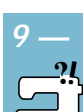

■ If You Make a Mistake Selecting the Character

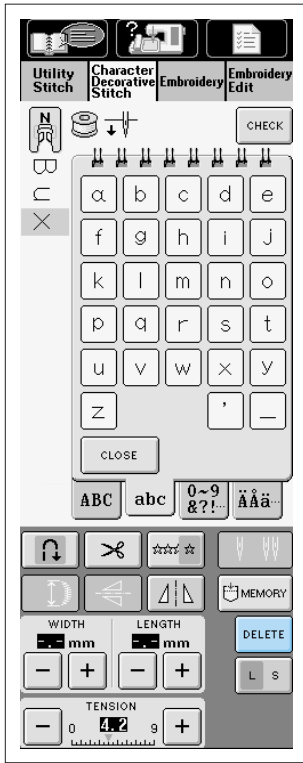

Press **DELETE** to delete the selected character. When you are combining patterns, the patterns are deleted in order, starting from the last selected character entered, each time you press the key.

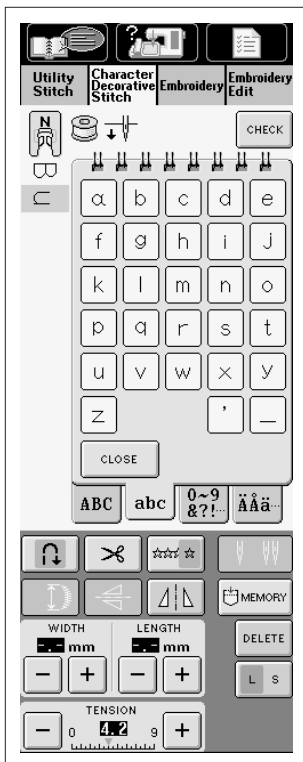

After the mistaken character is erased, select the correct character.

SEWING CHARACTER/DECORATIVE STITCH PATTERNS

Sewing Attractive Finishes

- To achieve attractive results when sewing character/decorative stitches, check the table below for the proper fabric/needle/thread combinations.
- Other factors, such as fabric thickness, stabilizer material, etc., also have an effect on the stitch, so you should always sew a few trial stitches before beginning your project.
- When sewing satin stitch patterns, there may be shrinking or bunching of stitches, so be sure to attach a stabilizer material.

Fabric	<p>When sewing on stretch fabrics, lightweight fabrics, or fabrics with coarse weaves, attach stabilizer material as an option. If you do not wish to do so, place the fabric on a thin paper such as tracing paper.</p> <div style="text-align: center;"> </div> <div style="text-align: right; margin-top: 10px;"> <p>① Fabric ② Stabilizer ③ Thin paper</p> </div>
Thread	#50 - #60
Needle	<p>With lightweight, regular, or stretch fabrics: the Ball point needle (golden colored) With heavyweight fabrics: home sewing machine needle 90/14</p>
Presser foot	<p>Monogramming foot "N". Using another presser foot may give inferior results.</p>



Basic Sewing of Character/Decorative Stitches

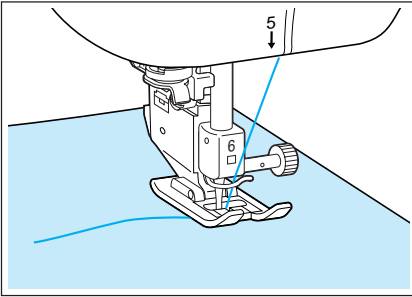

1. Select a stitch pattern.
2. Attach monogramming foot "N".
3. Place the fabric under the presser foot, pull the upper thread out to the side and then lower the presser foot.

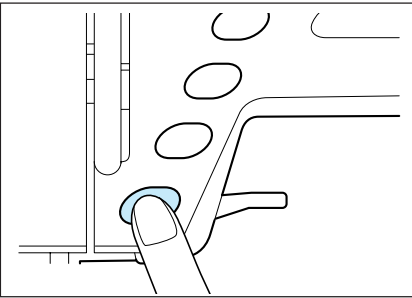

4. Press the "Start/Stop" button to begin sewing.

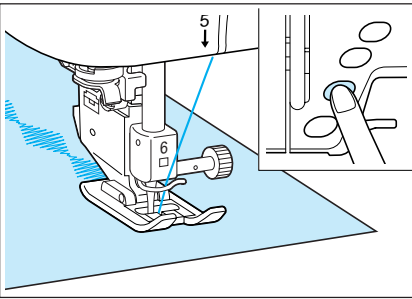

5. Press the "Start/Stop" button to stop sewing, then press the "Reverse/Reinforcement Stitch" button to sew reinforcement stitches.

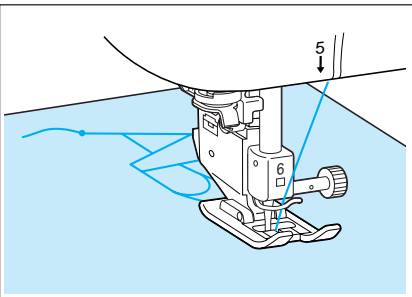

When Sewing Character Stitches

When sewing is finished, the machine will automatically sew reinforcement stitches, then stop.

Note

When sewing character stitches, the machine automatically sews reinforcement stitches at the beginning and end of each character.

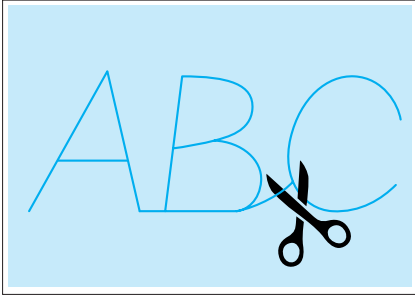

When sewing is completed, trim any excess thread.

CAUTION

When sewing some patterns, the needle will stop in the raised position while the fabric is fed due to the operation of the needle bar separation mechanism, which is used in this machine. At such times, a clicking sound different from the sound generated during sewing will be heard. This sound is normal and is not the sign of a malfunction.



Making Stitch Pattern Adjustments

Your stitch pattern may sometimes turn out poorly, depending on the type or thickness of fabric, the stabilizer material used, sewing speed, etc. If your sewing does not turn out well, sew trial stitches using the same conditions as the real sewing, and adjust the stitch pattern as explained below.

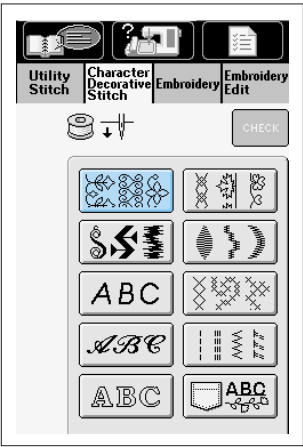

1. Select a stitch pattern to adjust.

① Press **Character Decorative Stitch**, then press

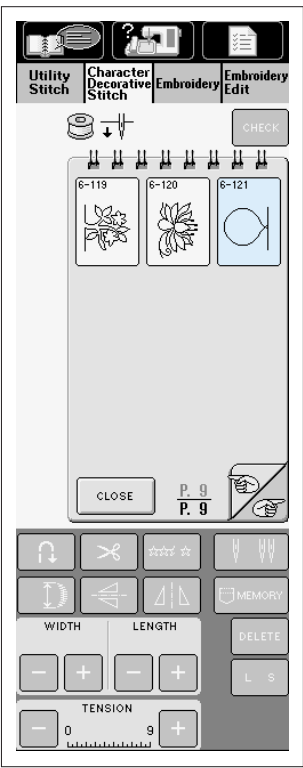

② Select on P.9 of this stitch pattern menu.

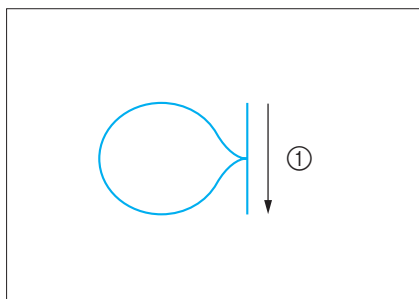
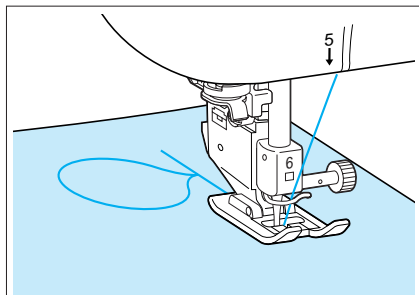

2. Attach monogramming foot “N” and start sewing. You can sew the pattern for adjusting.



Example: Correct pattern

① Sewing direction

3. Look at the finished stitch pattern, then make the necessary adjustments. Press  to call the screen at left.



4. If the stitches are bunched vertically :

Press  in the  display.



If the stitches have gaps between them vertically :

Press  in the  display.



If the stitches are bunched horizontally :

Press  in the  display.



If the stitches have gaps horizontally :

Press  in the  display.



5. Sew the stitch pattern again.



CAUTION

You can sew while the Settings screen is displayed.

6. If the pattern still comes out poorly, do the adjustments again. When the stitch pattern is sewn correctly, stop adjusting.

Press  to return to the original screen.

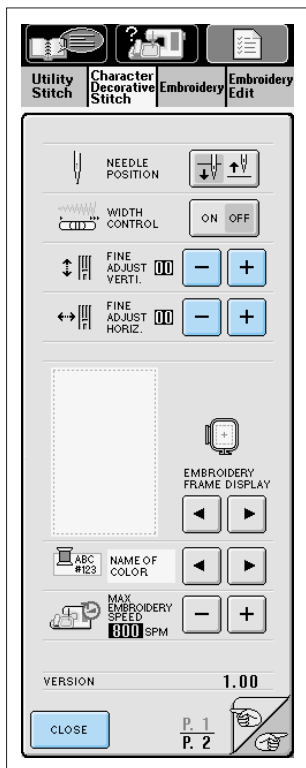

EDITING CHARACTER/DECORATIVE STITCH PATTERNS

You can create just the finish you want using the editing functions. Make patterns larger or smaller, make mirror images, etc.

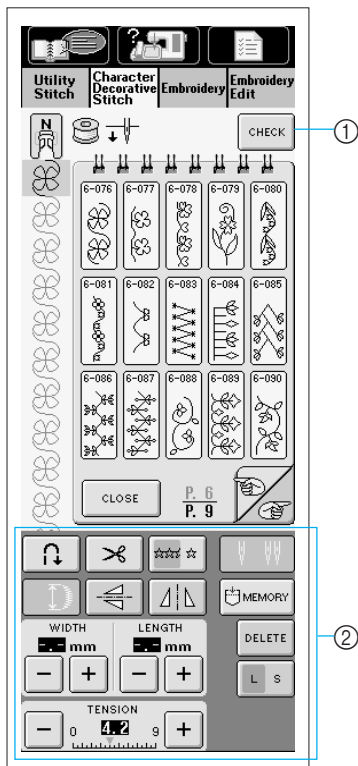













- ① Use this key to check large combination patterns.
- ② Stitch editing keys:
Use the pink keys to edit the pattern when you select it.
Use the green keys to make adjustments when sewing.

CAUTION
Some editing functions can not be used with certain stitch patterns. If the key display is light gray, that function can not be used with the selected stitch pattern.



■ Key Functions

Key or Display	Name	Function of the key or display	Page
	Automatic reinforcement stitch key	Press this key to turn on the automatic reinforcement stitching mode.	2-14
	Automatic thread cutting key	Press this key to turn on the automatic thread cutting mode.	2-15
	Single/Repeat sewing key	Press this key to choose single stitches or continuous stitches.	4-17
	Needle mode selection key (Single/Double)	Press this key to choose single needle sewing or twin needle sewing.	2-5
	Elongation key	When 7mm satin stitch patterns are selected, press this key to choose from 5 automatic length settings, without changing the stitch zigzag width or stitch length settings.	4-16
	Vertical mirror image key	After selecting the stitch pattern, use this key to create a vertical mirror image of the stitch pattern.	4-16
	Horizontal mirror image key	After selecting the stitch pattern, use this key to create a horizontal mirror image of the stitch pattern.	4-16
	Size selection key	Use this key to select the size of the stitch pattern (large, medium, small).	4-15
	Delete key	When you make a mistake selecting a stitch pattern, use this key to erase the mistake. When you make a mistake in combining stitch patterns, use this key to delete stitch patterns in order from back to front.	4-2, 4-7
	Memory key	Use this key to save stitch pattern combinations.	4-27
	Stitch width and stitch length key	Shows the stitch width and stitch length of the selected stitch pattern. The machine has default settings.	2-8, 2-9
	Thread tension key	Shows the thread tension setting for the selected stitch pattern. The machine has default settings.	2-13



Changing the Size of the Stitch Patterns

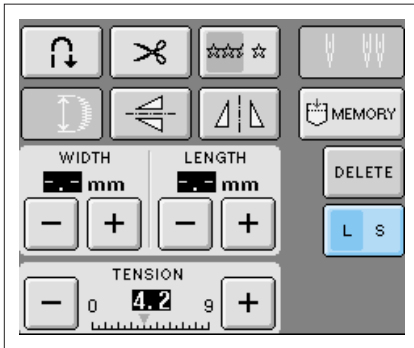

Select a stitch pattern, then press **L S** to change the size of the stitch pattern. The stitch pattern will be sewn in the size highlighted on the key. If you continue entering stitch patterns after changing the size, those patterns will also be sewn in that size.

Note

You can not change the size of combined stitch patterns once the stitch pattern is entered.

Actual Stitch Pattern Size



Changing the Stitch Pattern Length (for 7mm Satin Stitch Patterns Only)

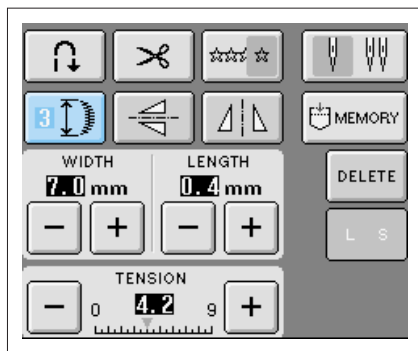

When stitch patterns are selected, press  to choose from 5 automatic length settings, without changing the stitch zigzag width or stitch length settings.

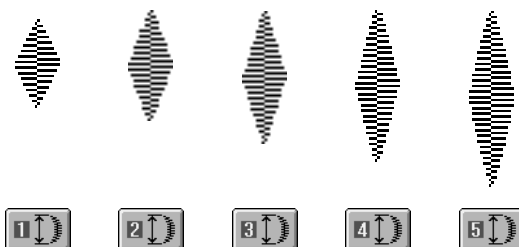

Creating a Vertical Mirror Image

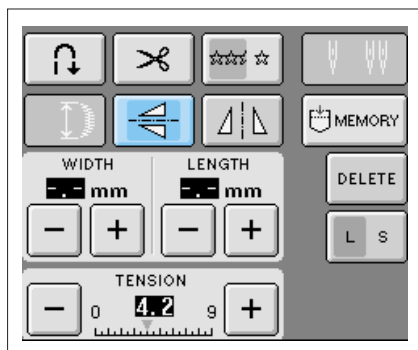

To create a vertical mirror image, select a stitch pattern then press .

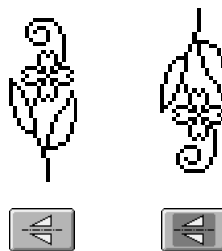

Creating a Horizontal Mirror Image

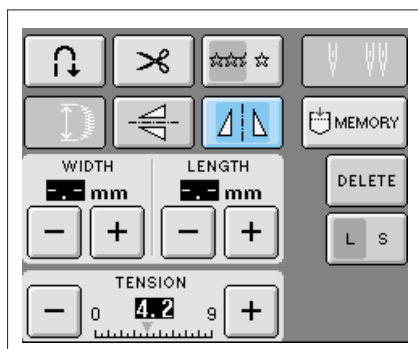

To create a horizontal mirror image, select a stitch pattern then press .

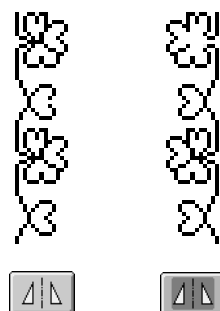

Sewing Pattern Continuously

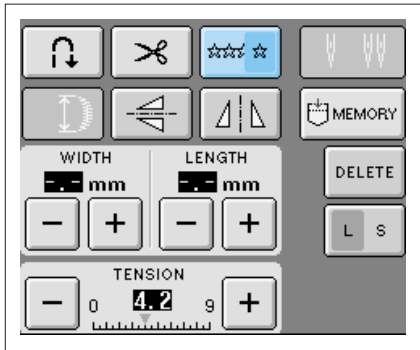

Press  to select continuous sewing or single stitch sewing.

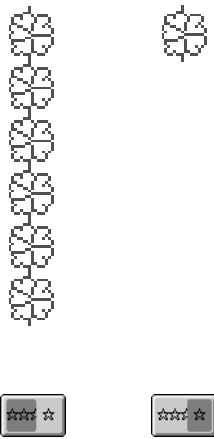

■ When Sewing the Pattern Continuously

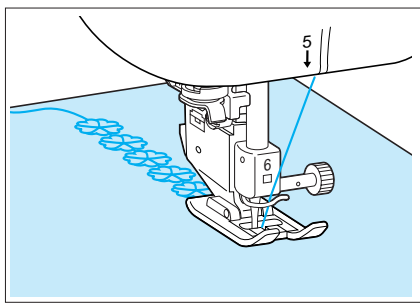

The machine sews the stitch pattern repeatedly. Press the “Start/Stop” button to stop sewing. Press the “Reverse/Reinforcement Stitch” button to sew reinforcement stitches.

Note _____
 To finish a complete motif while sewing the pattern continuously, you can press the  key while sewing. The machine will automatically stop when the motif is finished.

■ When Sewing Single Stitches

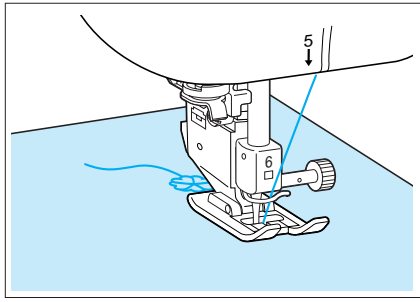

The machine will sew one cycle then stop automatically. Press the “Reverse/Reinforcement Stitch” button to sew reinforcement stitches.

Note _____
 When sewing character stitches, the machine automatically sews reinforcement stitches at the beginning and end of each sewing.

COMBINING STITCH PATTERNS

You can combine many varieties of stitch patterns, such as character stitches, cross stitches, satin stitches, etc. You can also combine stitch patterns of different sizes, mirror image stitch patterns, and others.

Before Combining Stitch Patterns

Single stitch sewing is automatically selected for sewing combined patterns. If you want to sew the pattern continuously, press  after finishing the stitch pattern combination.

When changing sizes, creating mirror images, or making other adjustments to a combined stitch pattern, be sure to edit the selected stitch pattern before selecting the next one. You can not edit a stitch pattern once the next stitch pattern is selected.

Combining Decorative Stitch and Character Stitch Patterns

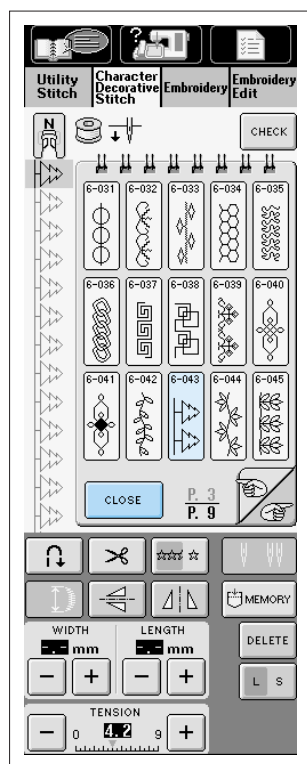

1. Select .

The screen at left will display.

2. Press  after choosing the stitch pattern.

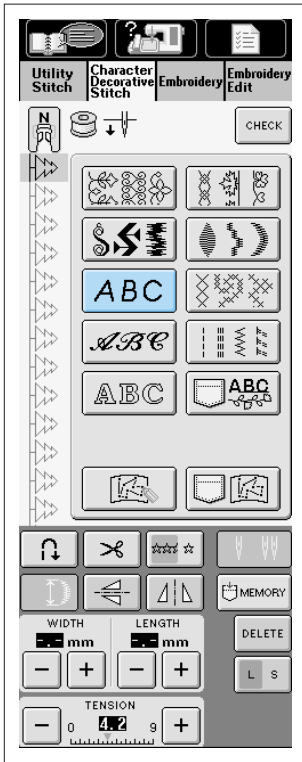

3. Return to the stitch selection screen.

* The screen displays the presser foot for the selected stitch.

4. Select the character stitch design (for example, press).

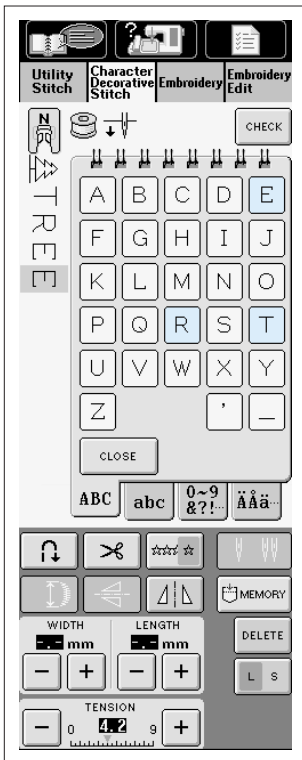

5. Select the characters (example; TREE).

* If you want to sew the pattern continuously, press .

* You can press to view the completed pattern (see page 4-26).

TREE

Combining Large and Small Stitch Patterns

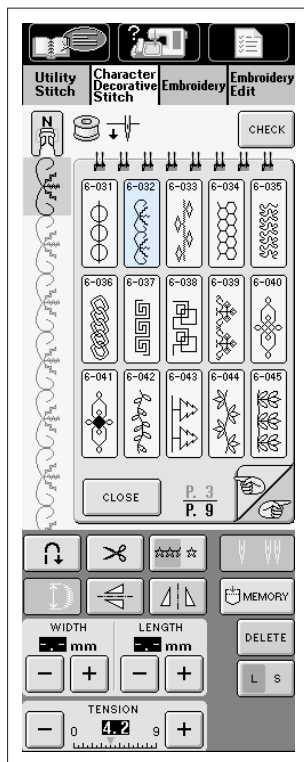

1. Press  to select the stitch pattern (the stitch will be selected in large size).

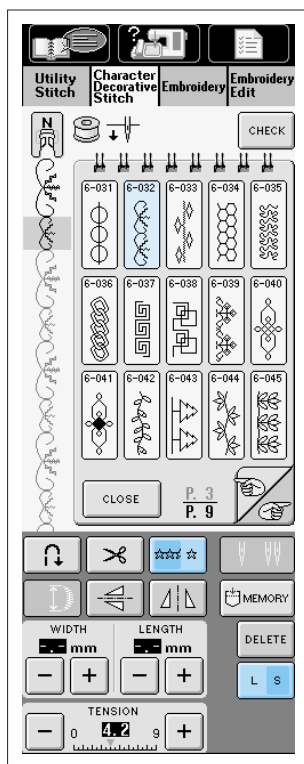

2. Press  again, then press  to select the small size.

* If you want to sew the pattern continuously, press .



Combining Horizontal Mirror Image Stitch Patterns

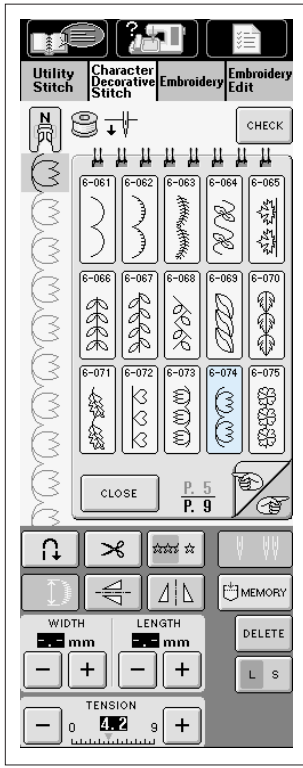

1. Press

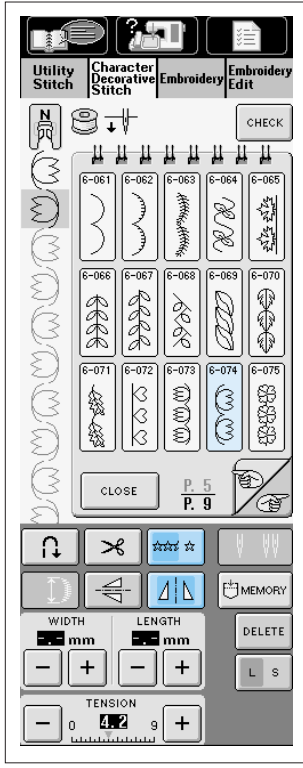

2. Press again, then press to create a horizontal mirror image of the stitch pattern.
 * If you want to sew the pattern continuously, press .



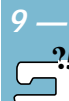

Combining Stitch Patterns of Different Lengths

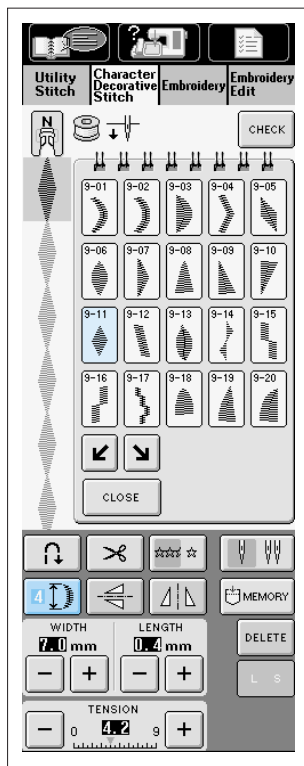

1. Select

2. Press to select a stitch pattern length setting of .

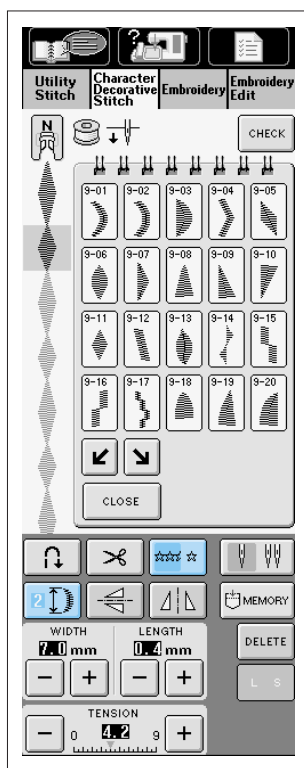

3. Select again.

4. Press 3 times to select a stitch pattern length setting of .

* If you want to sew the pattern continuously, press .



Making Step Stitch Patterns (for 7mm Satin Stitch Patterns Only)

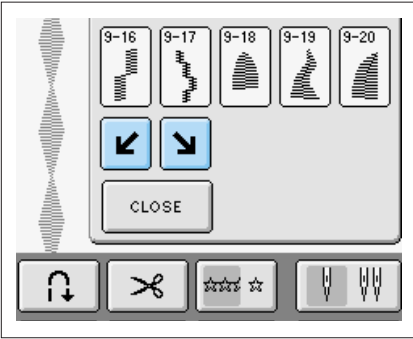

You can use the keys with 7mm satin stitch patterns to create a step effect.

Stitch patterns sewn so that they create a step effect are called step stitch patterns.

Press to move the stitch pattern a distance equal to half of the stitch pattern's size to the left.

Press to move the stitch pattern a distance equal to half of the stitch pattern's size to the right.

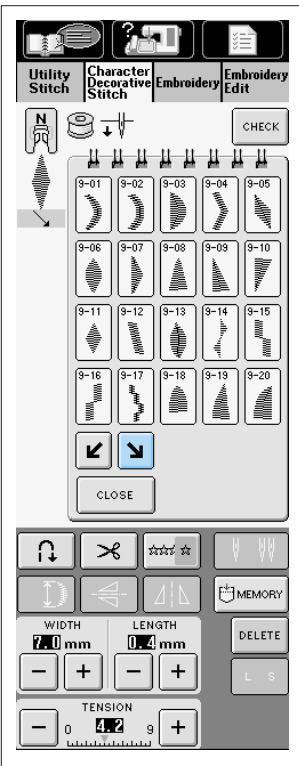

Example: Sewing



1. Press .

2. Press to move the next stitch pattern to the right.

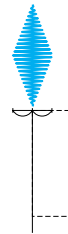

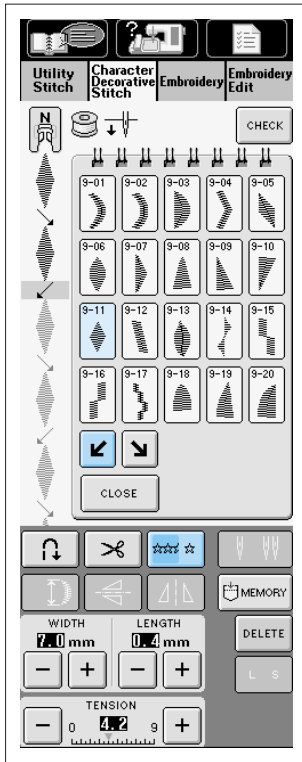

3. Press  again.

4. Press  to move the next stitch pattern to the left.

5. Press  to sew the pattern continuously.



More Examples

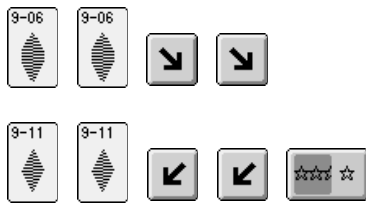
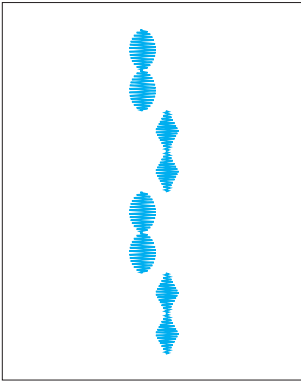
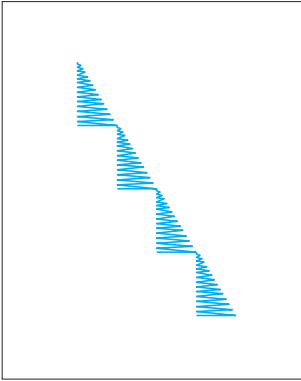
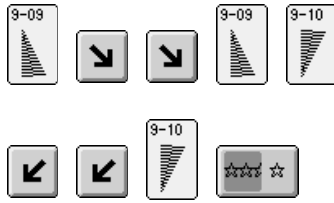
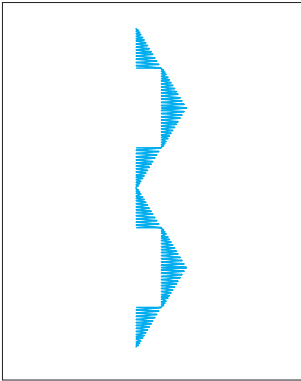
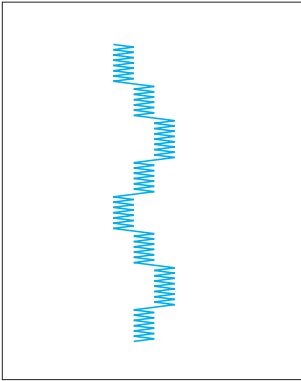



Checking Combined Stitch Patterns

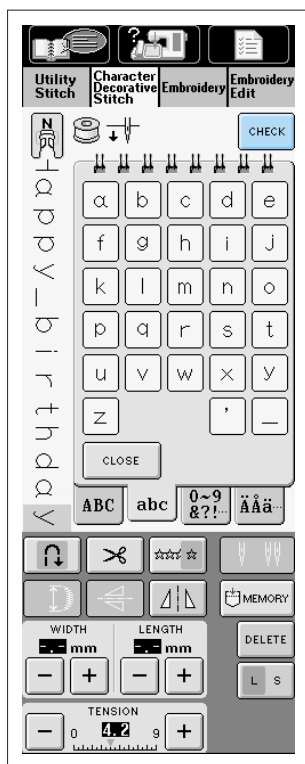

1. Press **CHECK**.

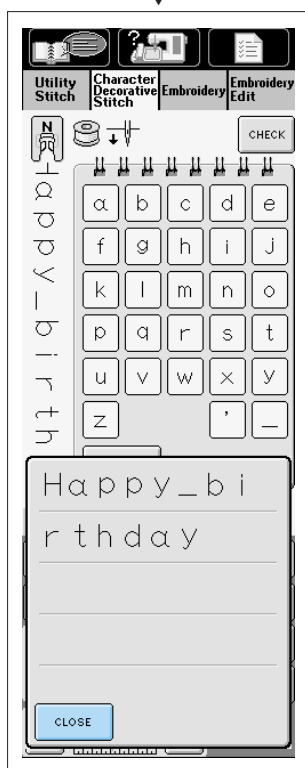

2. The entire selected stitch pattern appears on the LCD.
3. After checking the combined pattern, press **CLOSE** to return to the original screen.

MEMORY FUNCTIONS

Saving Stitch Patterns

You can save often used stitch patterns for easy retrieval. The machine memory can hold up to 20 stitch patterns.

Example: Saving "Happy birthday"

1. Create the pattern combination (see the previous section).

2. Press .

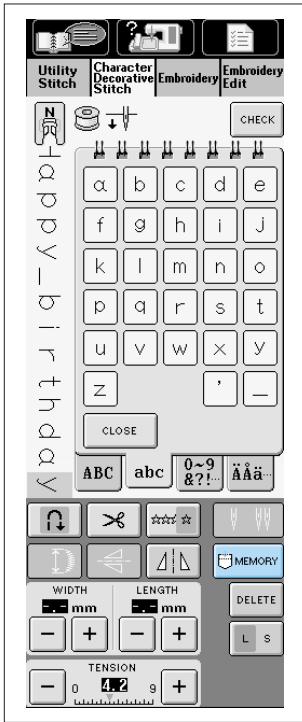

3. The screen at left will display. The machine will automatically save the stitch pattern and return to the original screen.

Note

It takes about 10 seconds to save a stitch pattern.

CAUTION

Do not turn off the machine while the "Saving" screen is showing. You may lose the data.

See page 4-31 for information about how to retrieving a saved stitch pattern.

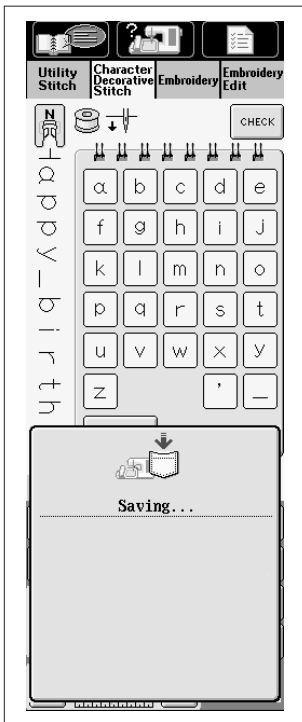



■ If You Can Not Save the Stitch Pattern

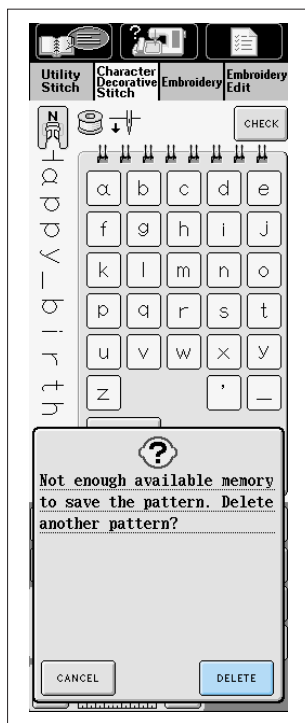

If you see this screen after pressing , the machine's memory is full and can not save the currently selected stitch pattern. To save the stitch pattern in the machine's memory, you have to delete a previously saved stitch pattern.

* If you decide not to save the stitch pattern, press .

Deleting a Previously Saved Pattern

1. Press .

2. The screen at left appears on the LCD.

*  represents a pocket holding a saved stitch pattern.

* Press . The stitch pattern saved in that pocket appears below the presser foot display.

* Press  if you decide not to delete the stitch pattern.

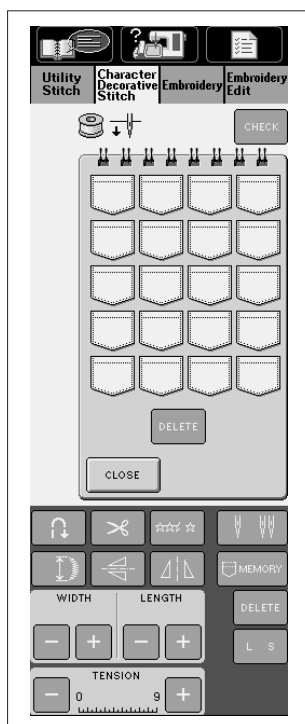

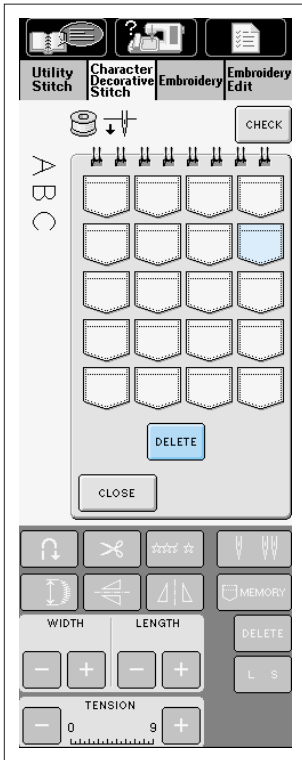

3. Press  to choose a stitch pattern to delete.

* If the entire saved stitch pattern is not displayed by touching

, press  to view the entire stitch pattern.

4. Press .

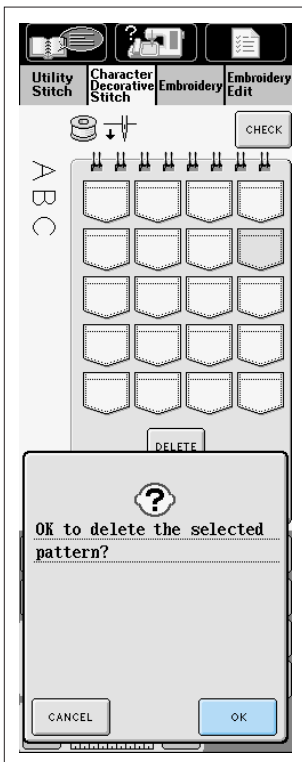

5. Press .

* If you decide not to delete the stitch pattern, press .

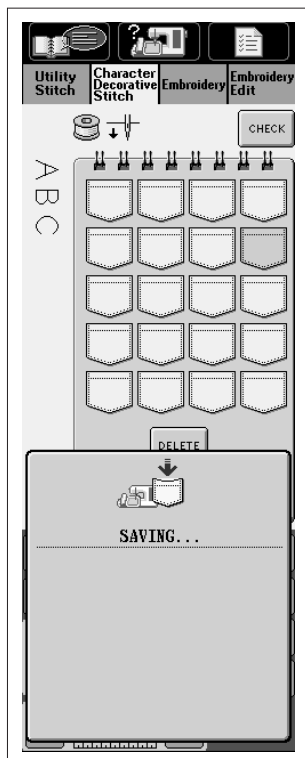

6. The machine deletes the stitch pattern, then automatically saves the new stitch pattern.

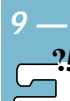

Retrieving Saved Stitch Patterns

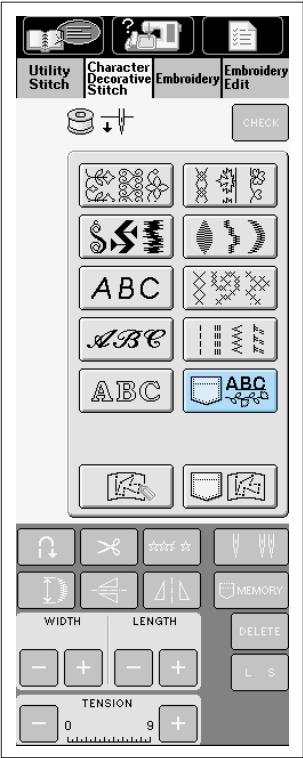

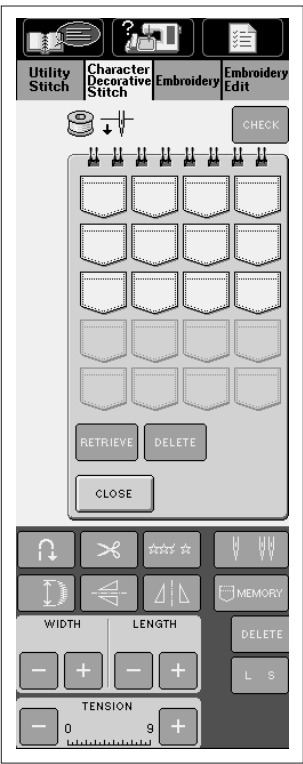

1. Press .

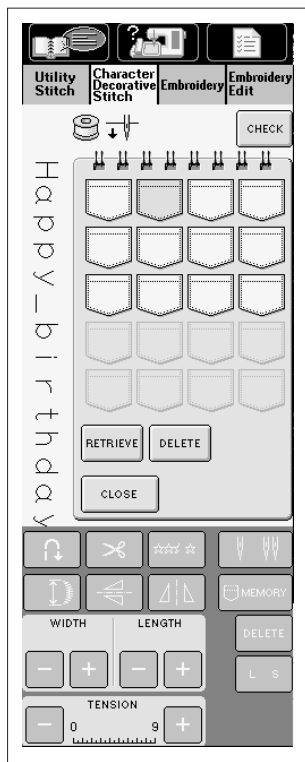

2. The screen at left appears on the LCD.

*  represents a pocket holding a saved stitch pattern.



3. Press  to display the saved stitch pattern, then press **RETRIEVE**.

* If you select a combined character stitch pattern and the entire pattern does not display, press **CHECK** to view an entire pattern.

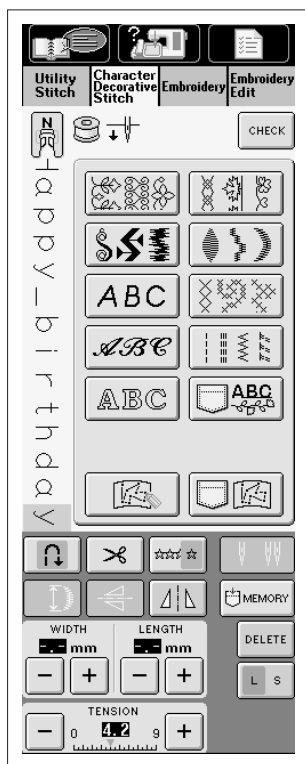

4. The pattern will be recalled, and the sewing screen will be displayed.

Chapter 5 Embroidery

PREPARING TO EMBROIDER

Before Beginning

■ Copyright Information

The patterns stored in the sewing machine and embroidery cards are intended for private use only. Any public or commercial use of copyrighted patterns is an infringement of copyright law and is strictly prohibited.

■ About the Embroidery Unit

▲ CAUTION

- Do not move the machine with the embroidery unit attached. The embroidery unit could fall off and cause injury.
- Keep your hands and foreign objects away from the embroidery carriage and frame when the machine is embroidering. Otherwise, injury may result.

CAUTION

- Do not touch the inner connector of the embroidery unit. The pins on the embroidery unit connection may be damaged.
- Do not apply strong force to the embroidery unit carriage, or pick up the unit by the carriage. Otherwise, the embroidery unit may be damaged.
- Store the embroidery unit in the proper storage case.

■ About Embroidery Cards (Sold Separately)

- Use only embroidery cards manufactured for this machine. Using unauthorized cards may cause your machine to operate incorrectly.
- Embroidery cards sold in foreign countries can not be used with this machine.
- Only insert or remove embroidery cards when  is displayed, or when the main power is off (see page 5-17).
- Store embroidery cards in the hard case.



■ About Floppy Disks

- If your machine did not come furnished with a built-in floppy disk drive, you can receive an upgrade service for your machine, so that it can use floppy disks at your authorized dealer.
- If floppy disks containing data other than that created for this machine, or patterns saved from your machine, are inserted into your machine, the machine may not operate correctly.
- Only insert or remove floppy disks when  is displayed, or when prompted to change disks by the screen (see page 5-18).
- Data saved on floppy disks may be lost or sometimes corrupted. Always make a backup of any important data saved on floppy disks.
- If the head of the floppy disk becomes dirty, the data can not be read normally. Use a cleaning disk for floppy disks regularly to avoid problems (see page 8-4). Be sure to follow the drive cleaning instructions on the package.
- Do not leave floppy disks where bits of thread or lint are likely to collect. These things may damage the disks. Put the disks in the hard case when storing.
- Do not leave floppy disks near the TV, magnets, or other objects with magnetic properties. Otherwise, the data on the disk may become unreadable.
- Floppy disks are 2HD type. Be sure to use formatted disks.
- Move the write protect switch on the floppy disk to the unprotected position before using the disk.
- Only use letters and numbers for the file names of the embroidery data. Using special symbols may prevent the data from being saved.

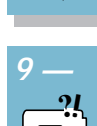

BASIC EMBROIDERY

Attach the presser foot, embroidery unit, and follow the other steps below to prepare the machine for embroidery.

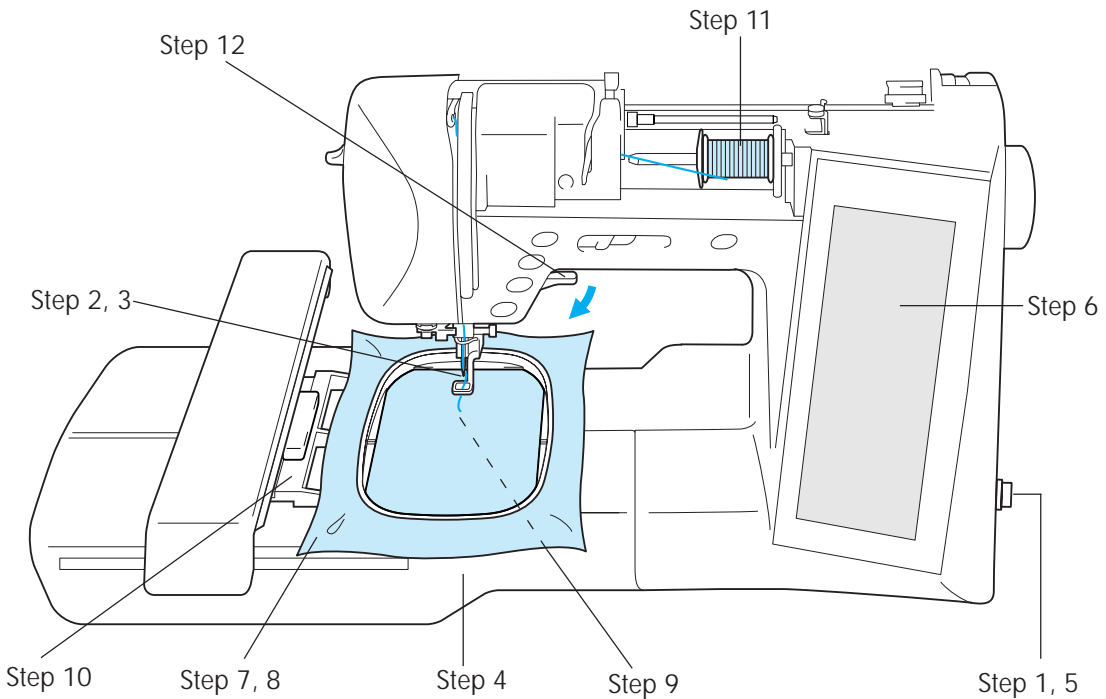

Step #	Action	Page
1	Turn off the power.	1-12
2	Install sewing machine needle 75/11.	1-43
3	Attach embroidery foot "Q".	5-4
4	Attach the embroidery unit.	5-5
5	Turn on the power.	1-12
6	Select an embroidery design.	5-8
7	Attach a stabilizer material to the fabric.	5-20
8	Place the fabric in the embroidery frame.	5-21
9	Place the bobbin, into bobbin case.	1-31
10	Attach the embroidery frame to embroidery unit.	5-24
11	Thread the machine.	1-32
12	Lower the presser foot and start embroidering.	5-30

Attaching Embroidery Foot "Q"

▲ CAUTION

- Always turn off the main power switch when attaching a presser foot. You may accidentally press the "Start/Stop" button, resulting in injury.
- Be sure to use embroidery foot Q when doing embroidery. The needle may strike the presser foot, causing the needle to bend or break and resulting in injury.

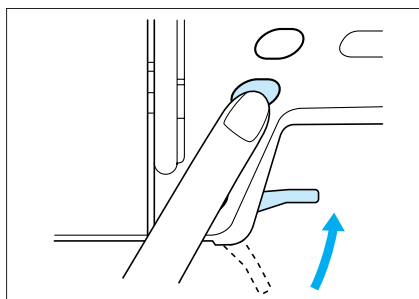

1. Press the "Needle Position" button to raise the needle, and then turn off the power.
2. Raise the presser foot lever.

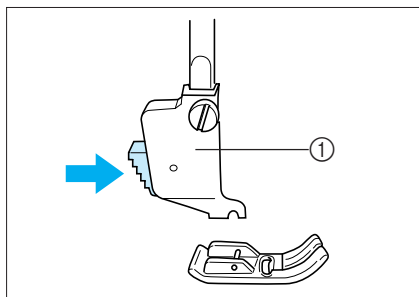

3. Push the black button on the presser foot holder and remove the presser foot.
 - ① Presser foot holder

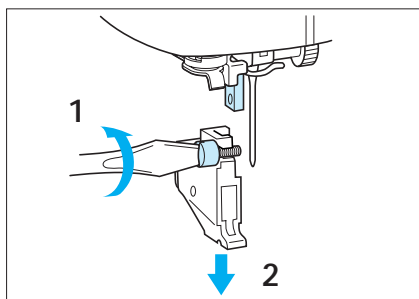

4. Use the included screwdriver to loosen the screw of the presser foot holder, then remove the presser foot holder.

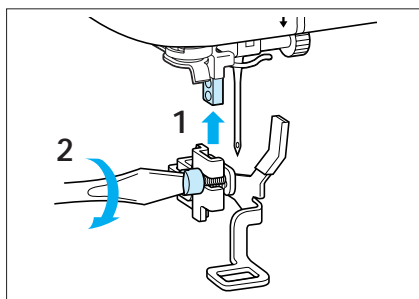

5. Set embroidery foot "Q" on the presser foot bar so that the arm of embroidery foot "Q" is in contact with the back of the needle holder, then use the included screwdriver to firmly tighten the screw.

▲ CAUTION

Use the included screwdriver to firmly tighten the screw of the presser foot holder. If the screw is loose, the needle may strike the presser foot, resulting in injury.

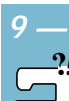

Attaching the Embroidery Unit

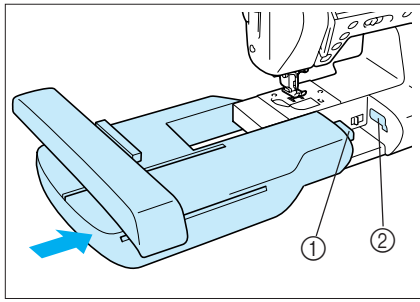
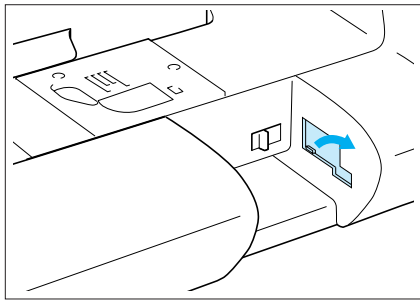
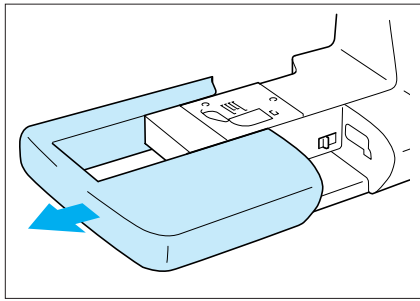

CAUTION

Be sure to turn off the power before installing the embroidery unit, otherwise, the machine may be damaged.

1. Turn off the power, and remove the flat-bed attachment.
2. Open the cover of the connection port, as shown in the illustration.

Note

Be sure to replace the cover when the embroidery unit is not installed.

3. Insert the embroidery unit connection into the machine connection port. Push lightly until the unit clicks into place.

- ① Embroidery unit connection
- ② Machine connection port

CAUTION

- Be sure there is no gap between the embroidery unit and the sewing machine. If there is a gap, the embroidery patterns will not embroider with the correct registration.
- Do not push on the carriage when installing the embroidery unit onto machine. Moving the carriage may damage the embroidery unit.

4. Turn on the main power switch. The screen at left will display.



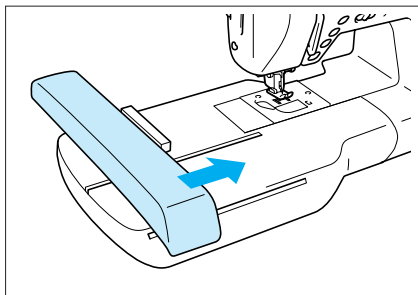

5. Press . The carriage will move to the initialization position.

▲ CAUTION

Keep your hands and foreign objects away from the carriage. Otherwise, injuries may result. Also, if the embroidery unit could not be initialized correctly, a buzzer will sound. If this happens, go through the initialization process again. This is not a malfunction.



■ Removing the Embroidery Unit

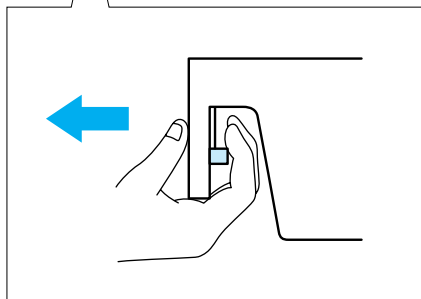
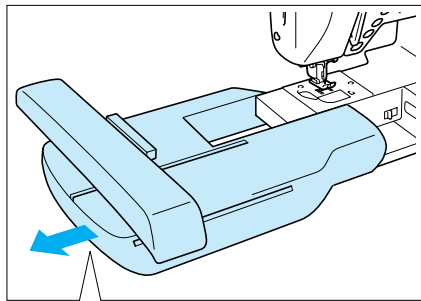
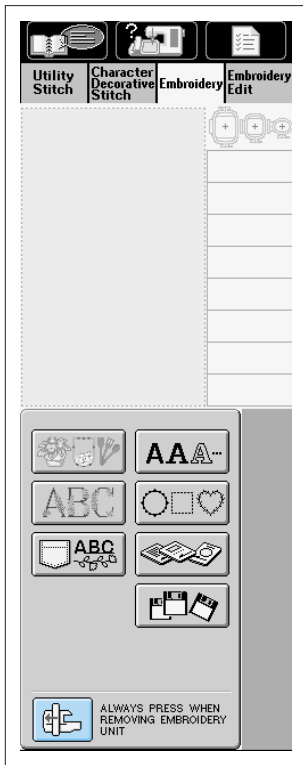

1. Remove the embroidery frame.

Press either **Embroidery** or **Embroidery Edit**, then press



. The carriage will move to the removal position.

▲ CAUTION

Always remove the embroidery frame before pressing . Otherwise, the frame may strike the embroidery foot, resulting in injury.

CAUTION

The embroidery unit will not fit in the storage case if this step is not done.

2. Turn off the main power switch. Hold the back left side of the embroidery unit. Hold down the release button, and pull the embroidery unit away from the machine as shown.

CAUTION

Be sure to turn off the main power switch. Otherwise, the machine may be damaged.

1 —



2 —



3 —



4 —



5 —



6 —



7 —



8 —



9 —







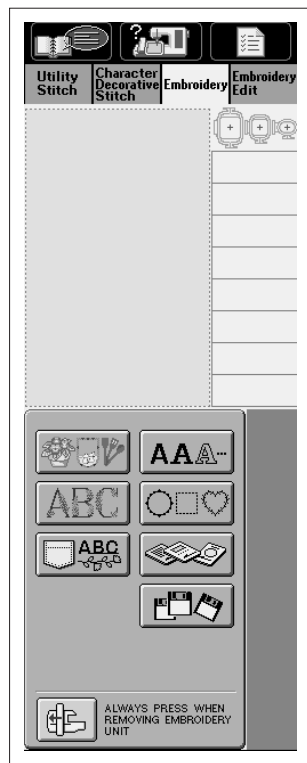

SELECTING PATTERNS

There are many character and decorative embroidery patterns stored in the machine's computer memory. You can also use patterns from the embroidery cards (sold separately).



Once the machine has finished the initialization and the carriage has moved to the start position, the pattern type selection screen will display.

If another screen is displayed, press **Embroidery** to display the screen at left.

	One point patterns		Character patterns
	Floral alphabet patterns		Frame patterns
	Saved patterns		Embroidery card (sold separately)
			Floppy disk



Note

If your machine did not come furnished with a built-in floppy disk drive, you can receive an upgrade service for your machine, so that it can use floppy disks at your authorized dealer.

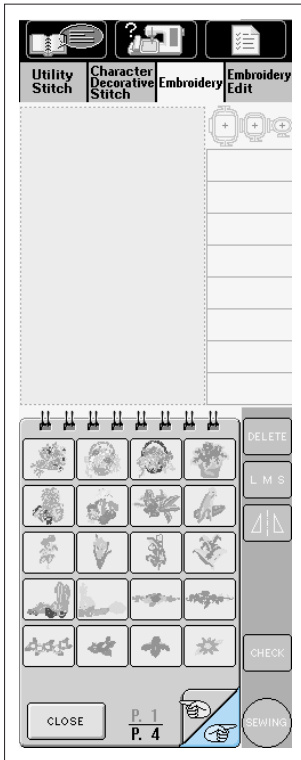
One Point Patterns

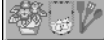

1. Press  to open the screen at left.

2. Press  to see the next screen of pattern selections. Press  to see the previous screen of pattern selections.

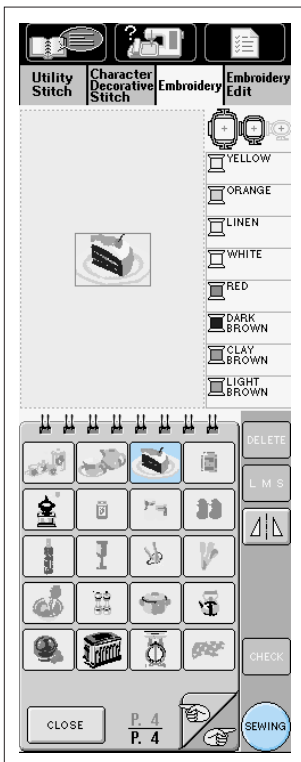

3. Press the key of the pattern you want to embroider.

4. The selected pattern is displayed in the top part of the screen.

* Press  to create a mirror image of the pattern.

* If you make a mistake selecting the pattern, press the key of the pattern you want to sew.

5. After selecting the pattern, press .

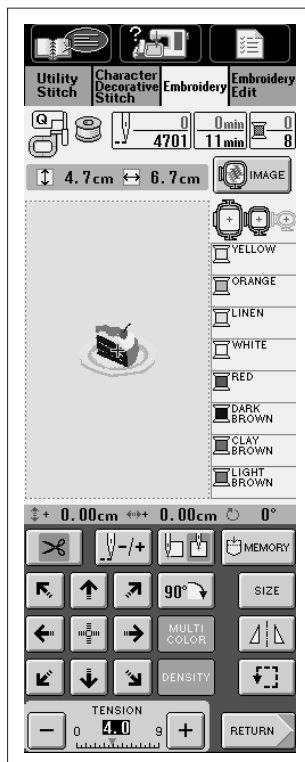

6. The sewing screen is displayed.

* To go to the next step, see page 5-19, "Viewing the Sewing Screen."

* To return to the previous screen to select another pattern, press



1 —



2 —



3 —



4 —



5 —



6 —



7 —



8 —



9 —



Character Patterns

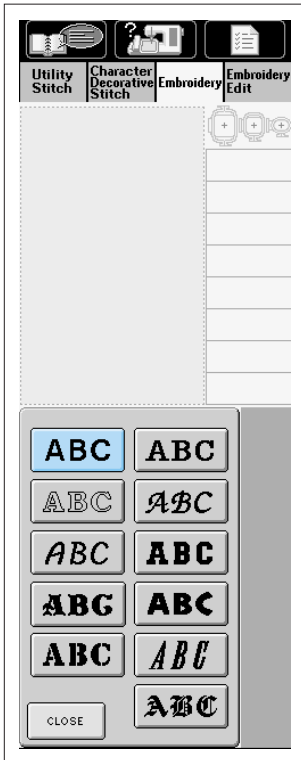

1. Press **AAA** to open the screen at the left.
2. The method for selecting character patterns is the same for each font. Press the key of the font you want to embroider.

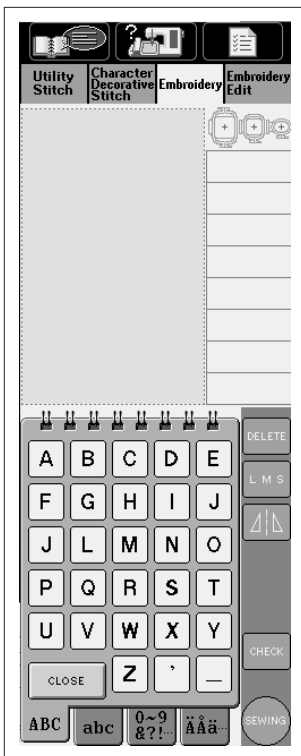

3. Use the tag keys **ABC** **abc** **0~9 &?!...** **AAa** to change the selection screen.
4. Press the key of the characters you want to embroider.

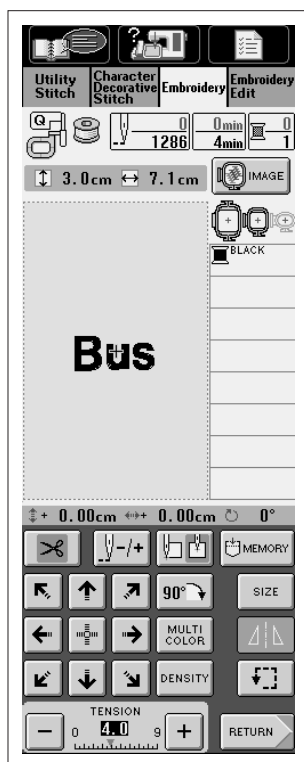
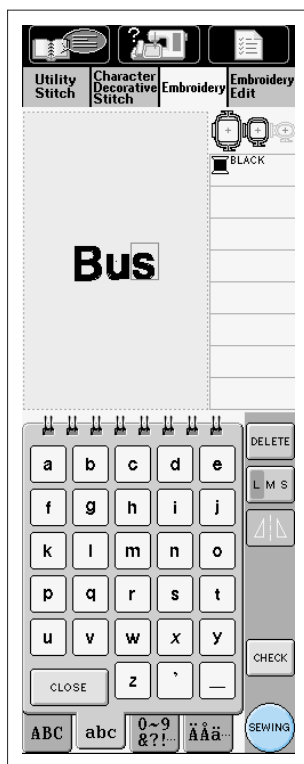

Example: Selecting "Bus"

① Press **B**.

- * If you want to change the size of the characters, select the character and then press **L M S** to change the size. Every time pressing the key, the size changes from large, medium, then small.
- * If you continue adding letters after changing the size, the new letters will be entered in the new size.

CAUTION

You can not change the size of the entered characters after combining a character stitch pattern.

② Press **abc**.

③ Press **u**.

④ Press **s**.



- * If you make a mistake, press **DELETE** to erase the mistake.
 - * If the pattern is too small to see clearly, you can use the **CHECK** key to check it.
6. When you finish selecting the characters, press **SEWING**.
7. The sewing screen is displayed.
- * To go to the next step, see page 5-19, "Viewing the Sewing Screen."
 - * To return to the previous screen to select another pattern, press

RETURN.

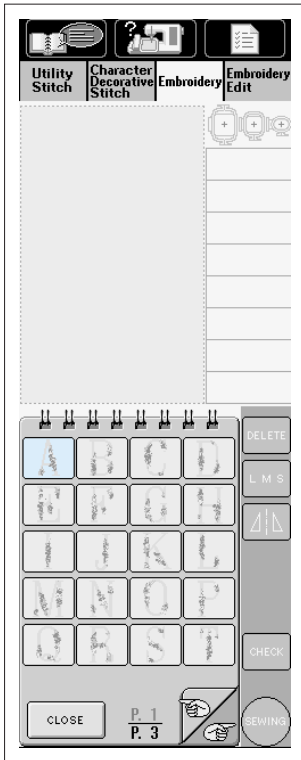
Floral Alphabet Patterns



1. Press  to open the screen at left.

2. Press  to see the next screen of pattern selections. Press  to see the previous screen of pattern selections.

3. Press the key of the pattern you want to embroider.

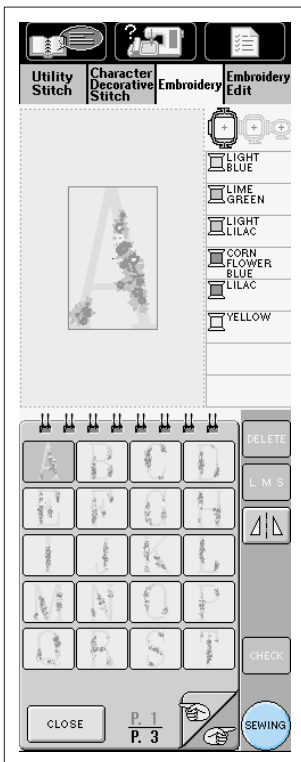

4. The screen displays the pattern.

* Press  to create a mirror image of the pattern.

5. After selecting the pattern, press .

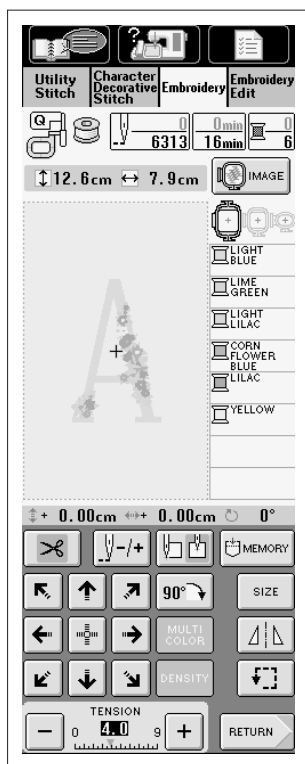

6. The sewing screen is displayed.

* To go to the next step, see page 5-19, "Viewing the Sewing Screen."

* To return to the previous screen to select another pattern, press

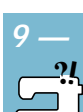

Frame Patterns

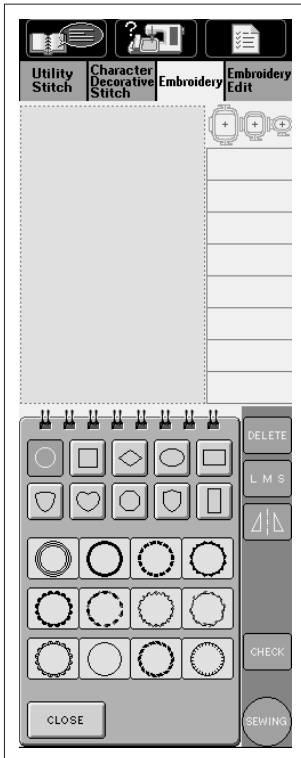

1. Press  to open the screen at left.
2. Press the key of the frame pattern shape you want to sew in the top part of the screen.
3. Various frame patterns display on the bottom part of the screen.
4. In the bottom part of the screen, press the key of the frame you want to sew.

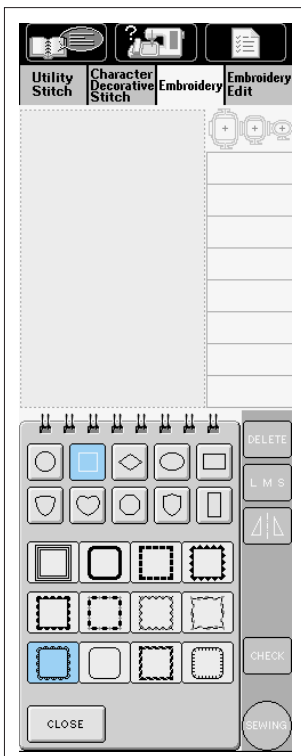

Example: Selecting

- ① Press  to choose the frame's shape. The lower display will show various square frames.

* If you make a mistake selecting the pattern, press the key of the pattern you want to sew.

- ② Press  to select the frame.

1 —



2 —



3 —



4 —



5 —



6 —



7 —



8 —



9 —

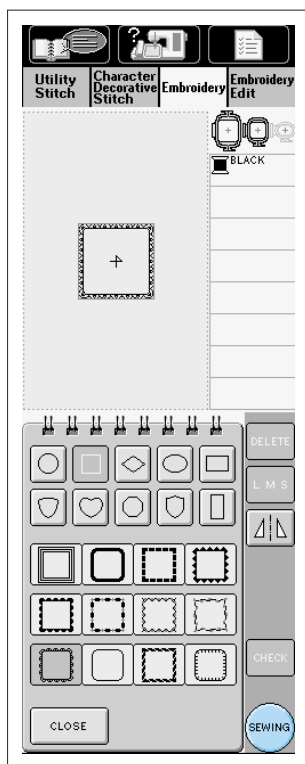

5. The selected pattern is displayed on the screen.

6. After selecting the pattern, press .

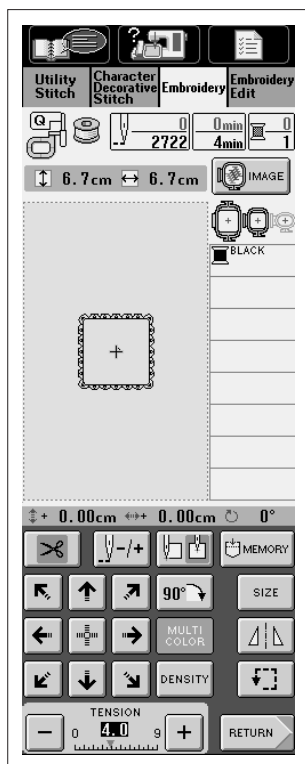

7. The sewing screen is displayed.

* To go to the next step, see page 5-19, "Viewing the Sewing Screen."

* To return to the previous screen to select another pattern, press



Selecting Patterns from an Embroidery Card

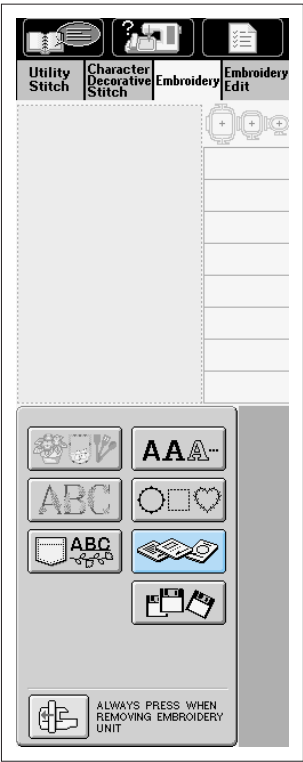

1. When the screen at left is displayed, you can insert the embroidery card.

- * If a different screen is showing, press **Embroidery** to display the screen at left.
- * Insert the card completely into the slot on the right side of the machine. Insert the embroidery card so that the end with a printed arrow is facing the front.

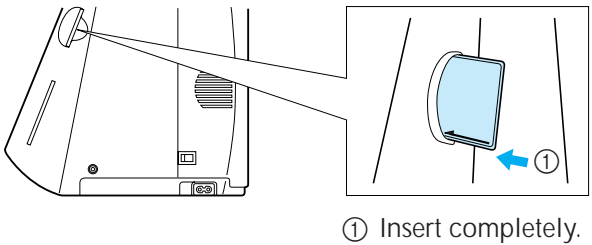

① Insert completely.

CAUTION

- Only insert or remove the embroidery card when  is displayed, or when the machine is turned off.
- Do not insert the card in a direction other than that shown by the arrow on the card, and do not force the card into the slot strongly. Do not put any object except for the embroidery cards into the slot. Otherwise, your machine may be damaged.

2. Press . The patterns on the embroidery card are displayed on the selection screen.

3. The method for selecting patterns is the same as that described on pages 5-8 to 5-16.

CAUTION

Use only embroidery cards intended for use with this machine. Using other cards may cause your machine to operate incorrectly.



Selecting a Pattern from a Floppy Disk (Only for Machines with Floppy Disk Drives)

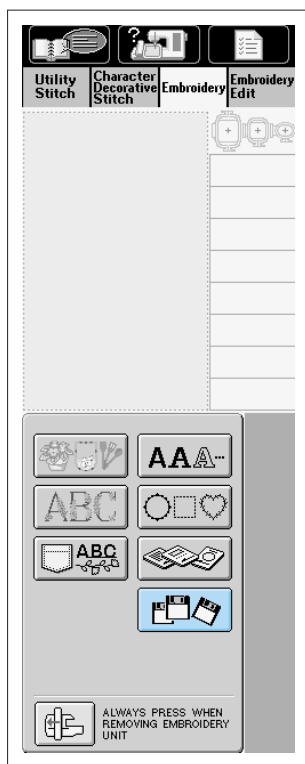

1. When the screen at left is displayed, you can insert the floppy disk.

- * If a different screen is showing, press **Embroidery** to display the screen at left.
- * Insert the floppy disk completely into the slot on the right side of the machine.

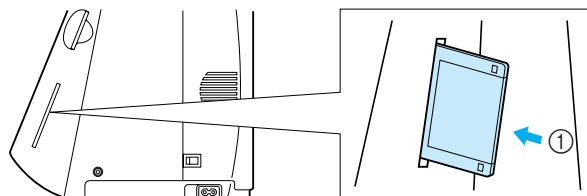

① Insert completely.

CAUTION

- Only insert or remove floppy disks when  is displayed, or when prompted to change disks by the screen.
- Do not put any object except for floppy disks into the floppy disk drive slot. Otherwise, your machine may be damaged.

2. Press .

The patterns on the floppy disk are displayed on the selection screen.

- * The time for loading from the floppy disk depends on a number of patterns. For example, it takes around 30 seconds for 20 patterns to display.

3. The method for selecting patterns is the same as that described on pages 5-8 to 5-16.

CAUTION

Only use floppy disks containing data created by the sewing machine, or equipment intended for this machine. Otherwise, the machine may not operate correctly.

VIEWING THE SEWING SCREEN

Example : One point pattern

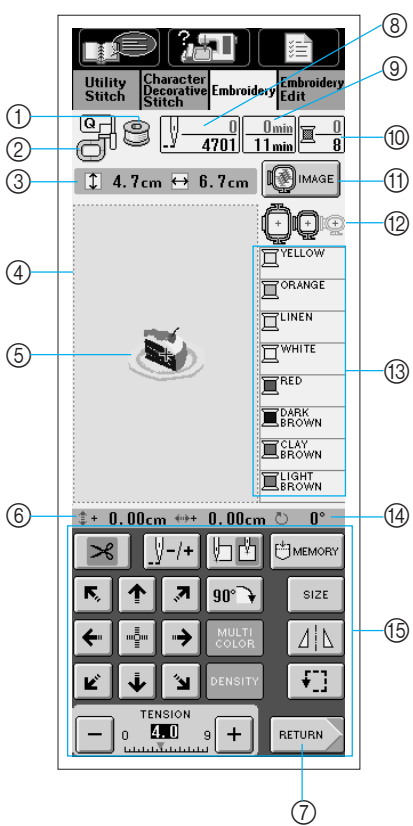

① Bobbin thread sensor: Shows how much thread is left in the bobbin during sewing. The display turns yellow if there is little thread remaining.

CAUTION
The bobbin thread sensor does not operate when the machine is not sewing.

② Presser foot code: Attach embroidery foot “Q” for all embroidery projects.

③ Shows the size of the selected pattern.

④ Shows the boundary for embroidering with the large frame (26 × 16 cm (10-1/4 × 6-1/4 inch)).

⑤ Shows a preview of the selected pattern.

⑥ Shows how far the sewing position is from the center (when you move the default sewing position).

⑦ Press this key to return to the pattern type selection screen.

⑧ Shows how many stitches in the selected pattern and how many stitches sewn so far.

⑨ Shows the time necessary to sew the pattern, and the time already spent sewing the pattern (not including time for changing the thread).

⑩ Shows the number of colors in the selected pattern, and the number of the color currently being sewn.

⑪ Press this key for a preview of the sewn image.

⑫ Shows the embroidery frames that can be used for the selected pattern. Be sure to use the proper frame (see page 5-21).

⑬ Shows the order the colors are sewn in.

⑭ Shows the degree of rotation of the pattern.

⑮ Pattern revision keys (see page 5-44).

CAUTION
Some operations or functions are not available for certain patterns. If the key display is light gray, you can not use that function or operation with the selected pattern.

PREPARING THE EMBROIDERY FRAME

Attaching a Stabilizer Material to the Fabric

▲ CAUTION

Always use stabilizer material for embroidery when sewing embroidery projects, especially when embroidering on lightweight or stretch fabrics. Otherwise, the needle may break and cause injury. Not using a stabilizer material may result in a poor finish to your project.

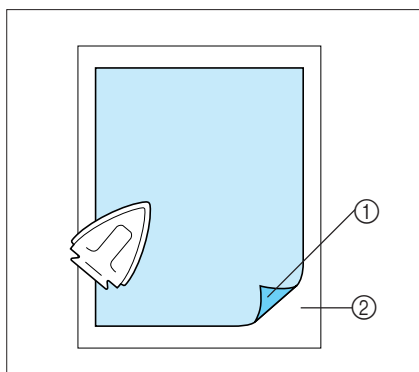

For best results in your embroidery projects, always use stabilizer material for embroidery. To prevent shrinking or other problems, follow the advice below.

1. Always use a stabilizer material for embroidery when sewing stretch fabrics, lightweight fabrics, fabrics with a coarse weave, or fabrics which cause pattern shrinkage. Iron the stabilizer material to the back of the fabric.

* When using fabrics that can not be ironed (such as towel or fabrics that have loops which expand when ironed), or in places where ironing is difficult, place the stabilizer material under the fabric without attaching it, then set the fabric and stabilizer in the embroidery frame, or check with your authorized dealer for the correct selection of stabilizer.

① Attached surface

② Fabric (reverse side)

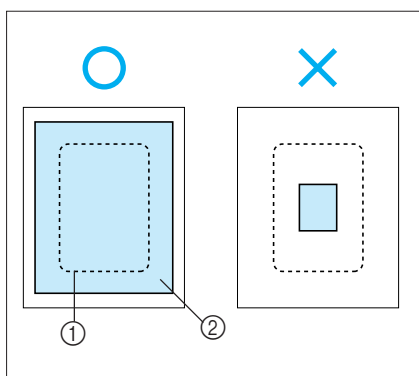

2. Use a piece of stabilizer material which is larger than the embroidery frame. Make sure that the stabilizer material is clamped all the way around the frame to prevent the fabric from loosening.

① Size of the embroidery frame

② Stabilizer material

Note

- For best results, we recommend you use stabilizer material for embroidery. Embroidery stabilizer material removes easily after embroidery. Follow stabilizer package instructions.
- When embroidering on thin fabrics such as organdy or lawn, or on shaggy fabrics such as towel or corduroy, use water soluble stabilizer material (sold separately) for best results. The water soluble stabilizer material will dissolve completely in water, giving the project a more attractive finish.



Setting the Fabric in the Embroidery Frame

Types of Embroidery Frames

Large	Medium	Small
Can embroider an area 26 cm × 16 cm (10-1/4 inch × 6-1/4 inch)	Can embroider an area 10 cm × 10 cm (4 inch × 4 inch)	Can embroider an area 2 cm × 6 cm (1 inch × 2-1/2 inch)
Use when embroidering connected or combined characters or patterns, or when embroidering large patterns.	Use when embroidering normal sized patterns.	Use for embroidering names or very small patterns.

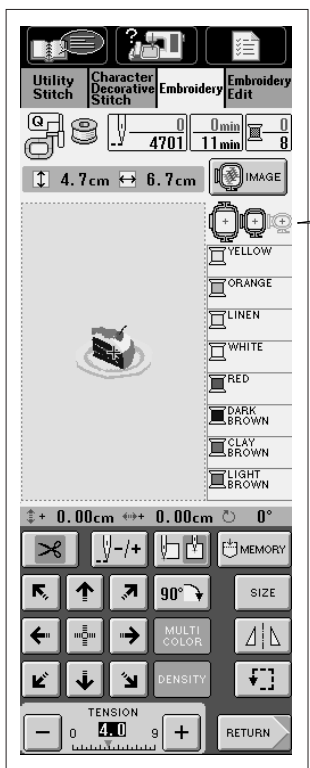

Select a frame that matches the pattern size. Frame options are displayed on the LCD.

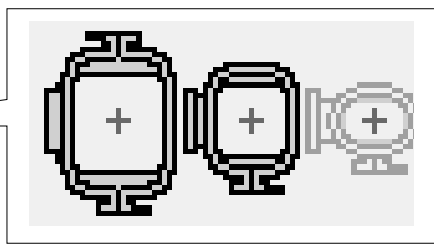

Frames that can be used are highlighted. Frames that can not be used are light gray.

⚠ CAUTION
If you use a frame that is too small, the presser foot may strike the frame during sewing and cause injury.

■ Inserting the Fabric

CAUTION

If the fabric is placed loose in the embroidery frame the embroidery design will sew out poorly. Insert the fabric on a level surface, and gently stretch the fabric tight in the frame. Follow the steps below to insert the fabric correctly.

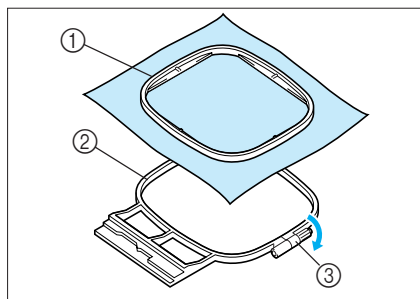

1. Loosen the adjustment screw on the outer embroidery frame. Lay the fabric on the outer frame, then insert the inner frame, clamping the fabric between the frames.

* Be sure to align the inner frame's \triangle with the outer frame's ∇ .

- ① Inner frame
- ② Outer frame
- ③ Adjustment screw

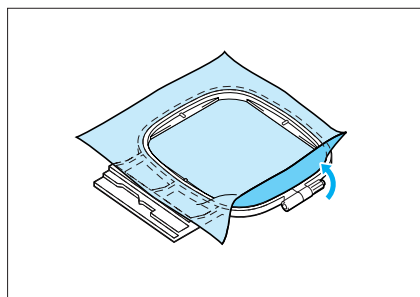

2. Slightly tighten the adjustment screw, then remove the slack of fabric by pulling on edges and corners. Do not loosen the screw.

* When using the large frame, tighten the adjustment screws at the top and bottom of the frame, so that the spaces at the top and bottom of the frame are equal.

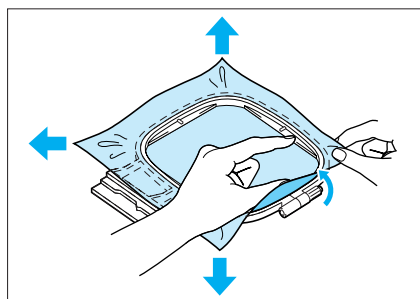
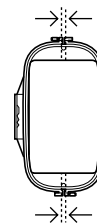

3. Gently stretch the fabric tight, and tighten the frame adjustment screw. This keeps the fabric from loosening after stretching.

* After stretching the fabric, make sure the fabric is taut.

* Make sure the inside and outside frames are even before you start embroidering.

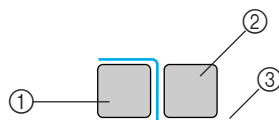

- ① Outer frame
- ② Inner frame
- ③ Surface of fabric

Note

Stretch the fabric by all four corners and all four edges. While stretching the fabric, tighten the frame adjustment screw with a screwdriver.



■ Using the Embroidery Sheet

When you want to embroider the pattern in a particular place, use the embroidery sheet with the frame.

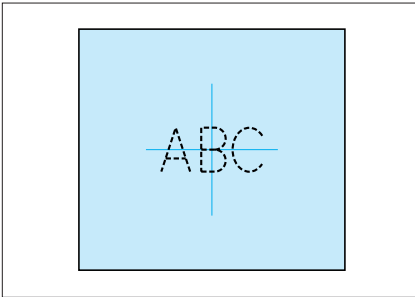

1. With a chalk pen, mark the area of the fabric you want to embroider.

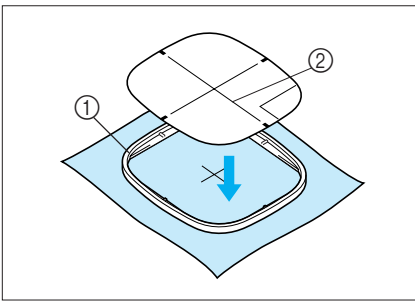

2. Place the embroidery sheet on the inner frame. Align the guide lines on the embroidery sheet with the mark you made on the fabric.
 - ① Inner frame
 - ② Guide line

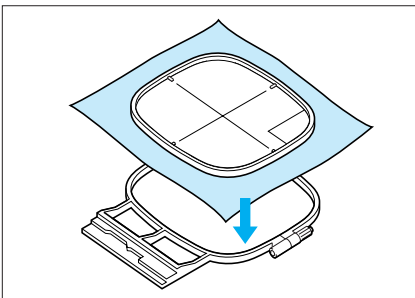

3. Gently stretch the fabric, so there are no folds or wrinkles.

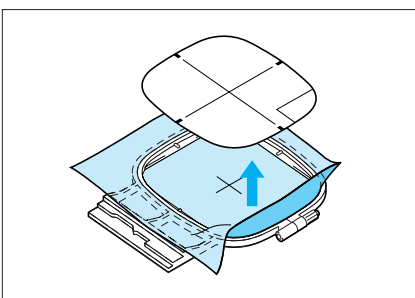

4. Remove the embroidery sheet.



Attaching the Embroidery Frame

CAUTION

Wind and set the bobbin before attaching the embroidery frame. Use embroidery thread in the bobbin.

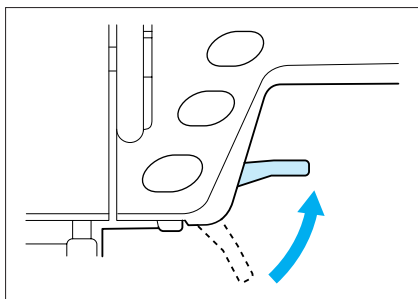

1. Raise the presser foot lever.

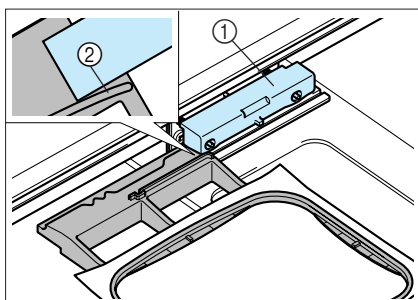

2. Align the embroidery frame guide with the left edge of the embroidery frame holder.

- ① Embroidery frame holder
- ② Embroidery frame guide

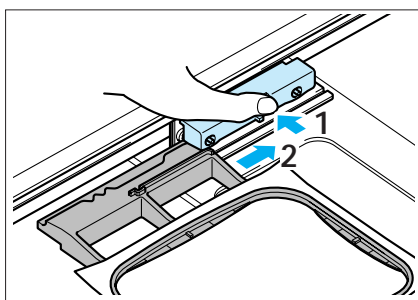

3. While pressing the embroidery frame holder to the left, slide the embroidery frame into the holder.

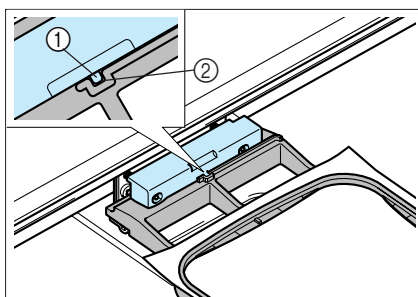

4. Align the projection on the embroidery frame holder with the groove in the embroidery frame, and return the embroidery frame holder to the original position.

- ① Projection
- ② Groove

▲ CAUTION

If the embroidery frame is set in the frame holder incorrectly, the frame may strike the presser foot, resulting in injury.

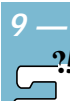

■ Removing the Embroidery Frame

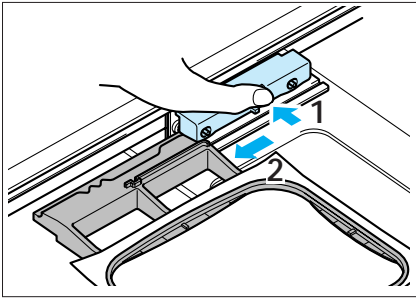



While pressing the embroidery frame holder to the left, pull the embroidery frame toward you.

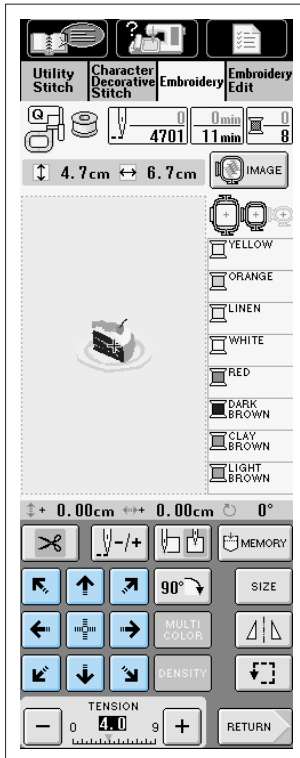

DETERMINING THE PATTERN POSITION

Changing the Pattern Position



Use the arrow keys  to move the pattern in the direction shown by the arrow.

Press  to center the pattern.

⚠ CAUTION

Make sure the needle is up when the embroidery frame is moving. If the needle is down, it could break and result in injury.

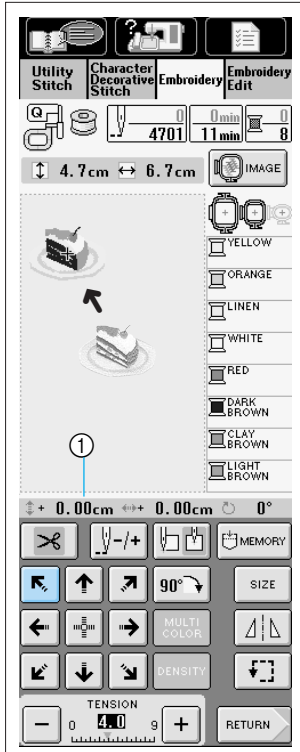

Example : Moving the pattern to the upper left

Press .

⚠ CAUTION

Moving the position of a pattern may affect which embroidery frames can be used to sew the pattern (the pattern may be moved outside the embroidery area of the frame). Always check the display to make sure which frames can be used before sewing the pattern. If you use a frame that is too small, the needle may strike the frame and break, resulting in injury.

① Shows how far the pattern has moved from center.



Checking the Pattern's Position

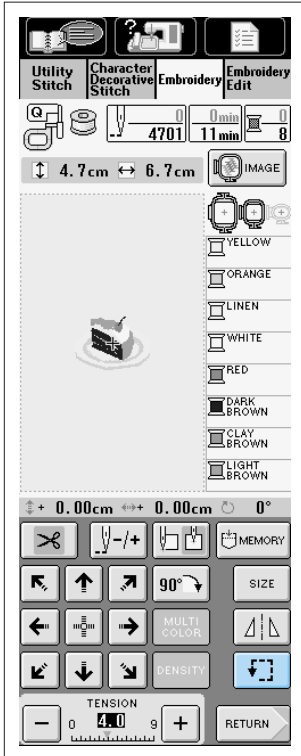

Press . The embroidery frame moves to check the sewing position.

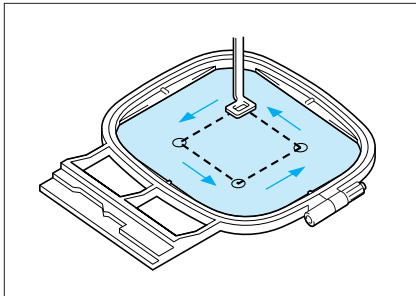

The embroidery frame moves and shows the boundaries of the embroidery. Watch the frame closely to make sure the pattern will be sewn in the right place.

CAUTION

Make sure the needle is up when the embroidery frame is moving. If the needle is down, it could break and result in injury.

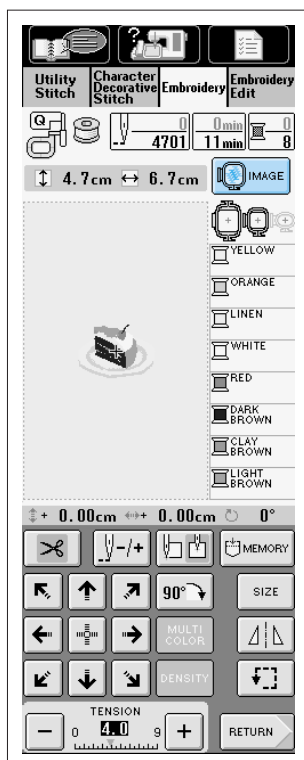

Previewing the Completed Pattern

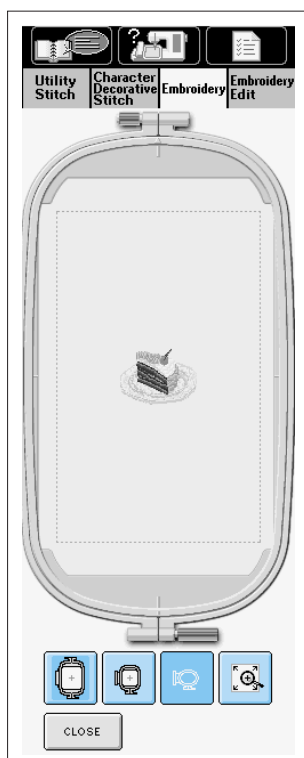

1. Press .



2. You can view an image of the completed pattern within the embroidery frame.

* Press    to select the frame used in the preview. Frames displayed a light gray color can not be selected.

* Press  to see a full screen preview.

3. Press  to return to the original screen.

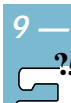

SEWING AN EMBROIDERY PATTERN

Sewing Attractive Finishes

There are many factors that go into sewing beautiful embroidery. Using the appropriate stabilizer fabric (see page 5-20) and setting the fabric in the frame (see page 5-21) are two important factors mentioned earlier. Another important point is the appropriateness of the needle and thread being used. See the explanation of threads below.

Thread	Upper thread	Use embroidery thread, or country embroidery thread intended for use with this machine.
	Bobbin thread	Use embroidery bobbin thread intended for use with this machine.

Note

If you use threads other than those listed above, the embroidery may not sew out correctly.



▲ CAUTION

- Do not embroider fabrics that are too thick. To check the fabric thickness, attach the embroidery frame to the embroidery unit, and use the “Needle Position” button to raise the needle. If there is a space between the presser foot and the fabric, the fabric can be embroidered. If there is no space, do not embroider the fabric. Otherwise, the needle may break, resulting in injury.
- In the case of thick terry cloth towels we recommend that you place a piece of water soluble stabilizer on the top surface of the towel. This will help to reduce the nap of the toweling and result in more attractive embroidery.
- Be careful when sewing overlapping patterns. The needle may not easily pierce the fabric, causing the needle to break.

CAUTION

- Before embroidering, check that there is enough thread in the bobbin. If you continue sewing without enough thread in the bobbin, the thread may tangle.
- Do not leave objects in the range of motion of the embroidery frame. The frame may strike the object and cause a poor finish to the embroidery pattern.
- When embroidering on large garments (especially jackets or other heavy fabrics), do not let the fabric hang over the table. Otherwise, the embroidery unit can not move freely, and the pattern may not turn out as planned.

■ Needle Plate Cover

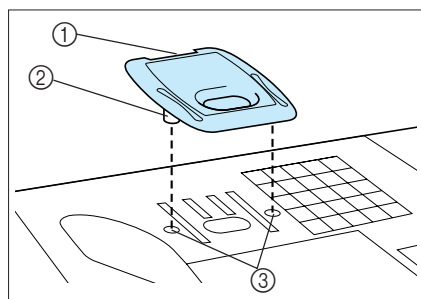

Under some conditions based on the type of fabric, stabilizer or thread being used there may be some looping in the upper thread. In this case, attach the included needle plate cover to the needle plate. To remove the needle plate cover, place your fingernail in the groove and lift the plate out.

- ① Groove
- ② Projection
- ③ Notch

* Do not use the needle plate cover for any applications other than embroidery.

Basic Embroidery Method

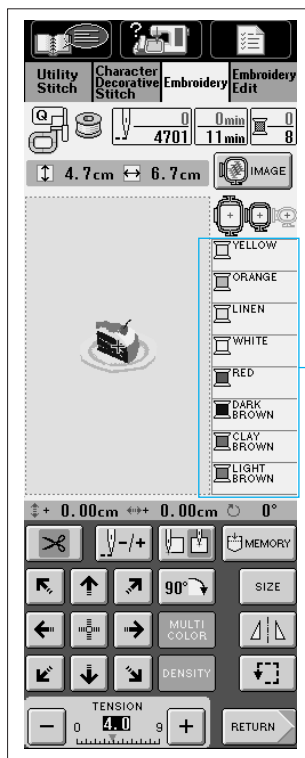

Example: Embroidering



- ① Embroidery color order display.
This display shows the sewing order of the thread colors.

The colors will be sewn in the following order:

yellow → orange → linen → etc.

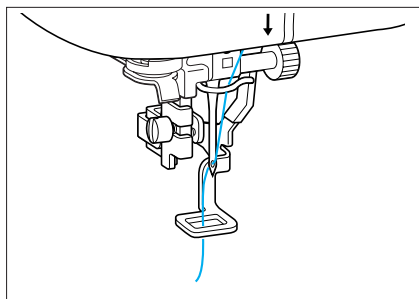

1. Thread the machine with the first color, and pass the end of the thread through the hole in embroidery foot Q.

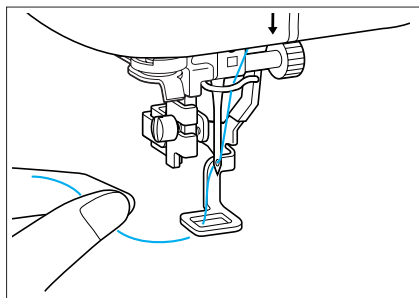

2. Grasp the end of the thread that is passed under the embroidery foot gently in your left hand. Be sure you leave enough slack in the thread.

▲ CAUTION

Pulling the thread too strongly may bend or break the needle, and lead to injury.

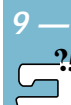

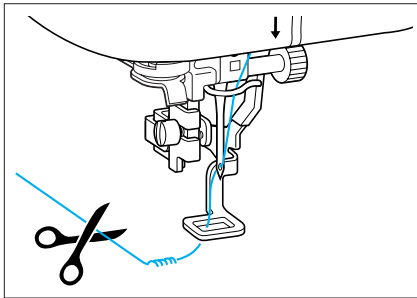
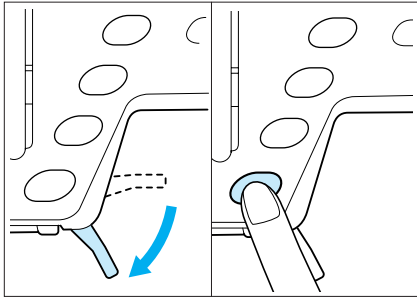

3. Lower the presser foot lever, then press the "Start/Stop" button to start embroidering. After 5-6 stitches, press the "Start/Stop" button again to stop the machine.

4. Trim the excess thread at the end of the seam. If the end of the seam is under the presser foot, raise the presser foot lever, then trim the excess thread.

* If there is thread left over from the beginning of sewing, it may be sewn over as you continue embroidering the pattern, making it very difficult to deal with the thread after the pattern is finished. Trim the threads at the beginning.

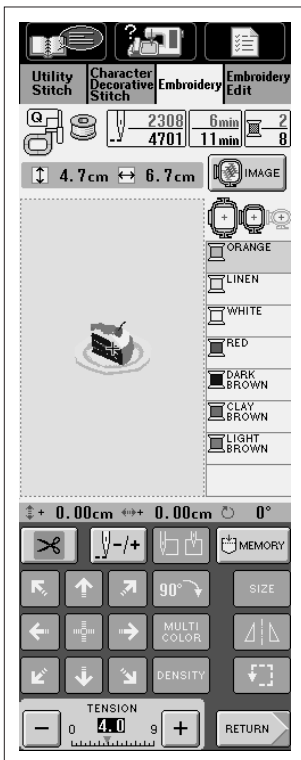

5. Press the "Start/Stop" button again to restart the machine. The [+] cursor moves over the pattern, showing which part of the pattern is being sewn.

6. When the first color is completely sewn, the machine will automatically trim the threads and stop. On the embroidery color order display, the next color will move to the top.

7. Raise the presser foot lever, and remove the first color of thread. Thread the machine with the next color.

8. Follow the same steps for embroidering the second color.



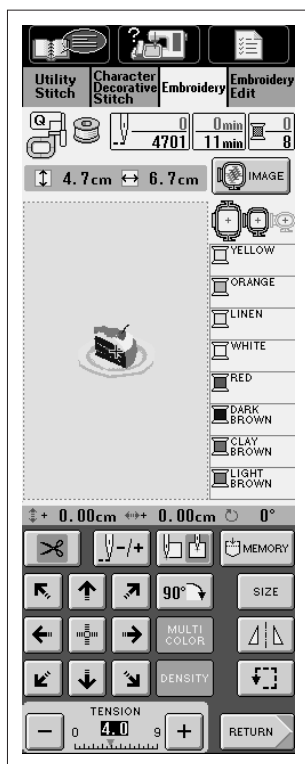
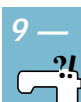

9. Follow the same steps for embroidering the remaining colors.

10. When the last color is sewn, the display returns to the original screen

11. When the pattern is finished, trim the excess thread jumps (thread linking part of the pattern, etc.).

■ Embroidering Order for Pattern Parts

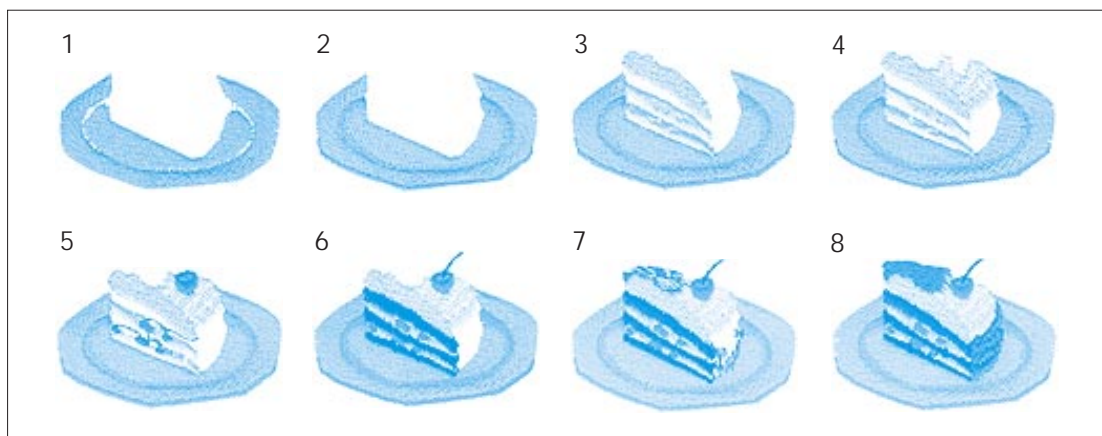

Sewing Embroidery Patterns Which Use Appliqué

There are some patterns which call for an appliqué inside the pattern.

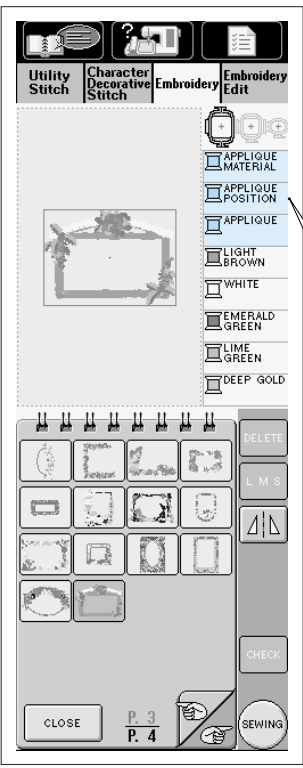

When sewing an embroidery pattern with an appliqué, the color sewing order display shows "Appliqué Material," "Appliqué Position," "Appliqué", and then the sewing order of the colors of the embroidery pattern to be sewn around the appliqué.

* Depending on the thread color display setting, the display may show , , or .

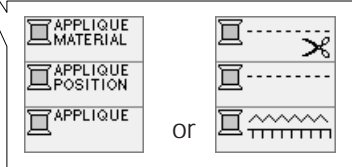

■ Directions for Appliqué

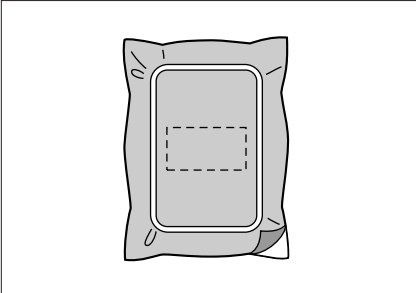

1. Attach a piece of stabilizer material to the back of the fabric you want to use for an appliqué.
2. Insert the fabric prepared in step one into a frame, then sew "Appliqué Material".

* The embroidery procedure is that same as the basic procedure explained on pages 5-30 to 5-32.

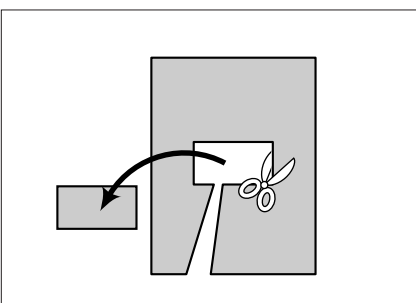

3. When sewing is finished, remove the fabric from the frame, and carefully cut around the pattern you just sewed.

* If you cut inside the stitching, you will be cutting the appliqué pattern and therefore, the thread will not catch the appliqué when sewing the appliqué onto another fabric. Therefore, please be careful when cutting. If this is not done carefully, the appliqué will turn out poorly. Trim the threads carefully.

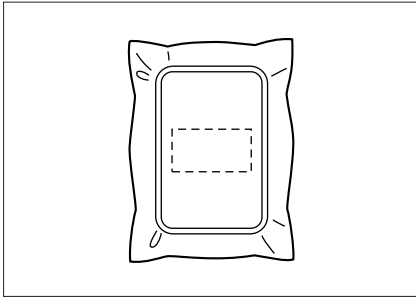

4. Set the base fabric for the appliqué in the embroidery frame, and embroider "Appliqué Position."

* Use the same thread color you plan to use when attaching the appliqué in the next step.

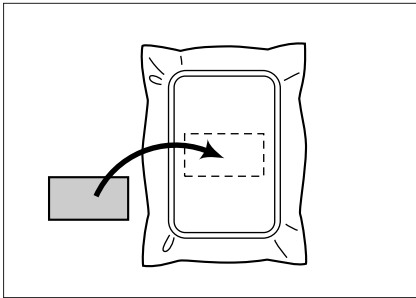

5. Apply a thin layer of fabric glue or temporary spray adhesive to the back of the appliqué material cut out in step 2, and place it on the base fabric, aligning the appliqué with the "Appliqué Position" pattern from step 4.

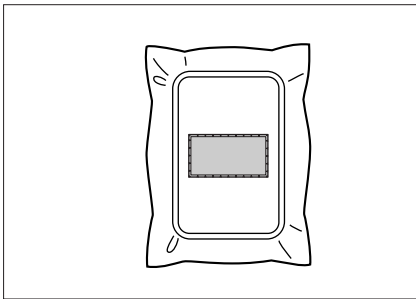

6. After attaching the appliqué material, sew "Appliqué."

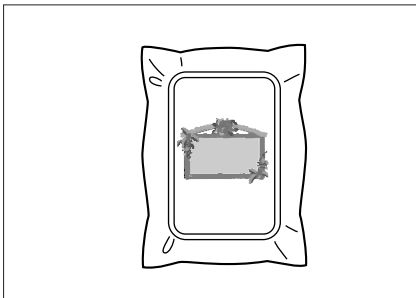

7. To sew the rest of the embroidery pattern, change the thread to the next thread color on the color sewing order display, and begin sewing.



ADJUSTMENTS DURING THE EMBROIDERY PROCESS

CONTENTS



Index

The Bobbin Runs Out of Thread

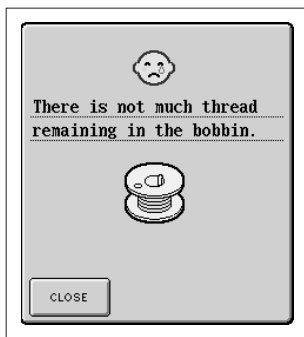

When the bobbin begins to run out of thread during sewing, the message shown at left will display. If the pattern is nearly complete at this time, you can finish the pattern safely without changing the bobbin thread. If there is a large portion of the pattern left to finish, it is recommended to change the bobbin thread before continuing. If the message at left displays, follow the steps below.

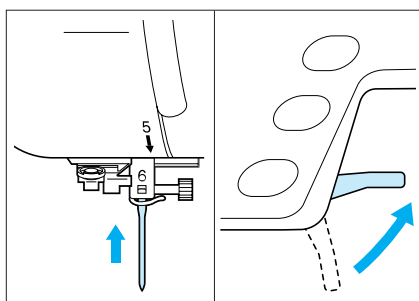

1. Press the "Start/Stop" button to stop the machine.
2. Press the "Needle Position" button to raise the needle, and raise the presser foot lever.

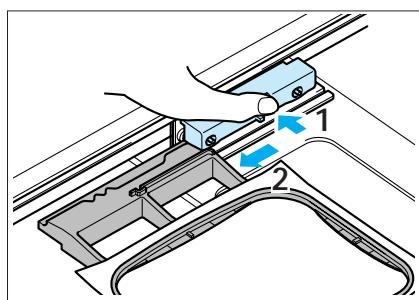

3. Use scissors to cut the upper thread.
4. Remove the embroidery frame.
Be careful not to apply strong force to the fabric at this time. Otherwise, the fabric may loosen in the frame.

CAUTION

Be careful not to bump the embroidery unit carriage or the presser foot when removing or attaching the embroidery frame. Otherwise, the pattern will not embroider correctly.

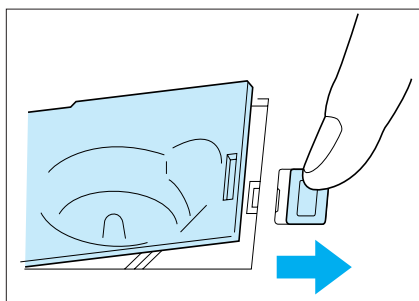

5. Insert a wound bobbin into the machine, then reattach the embroidery frame.
6. To return to the spot in the pattern where you stopped sewing, go to page 5-36 and follow the steps from #4.

The Thread Breaks During Sewing

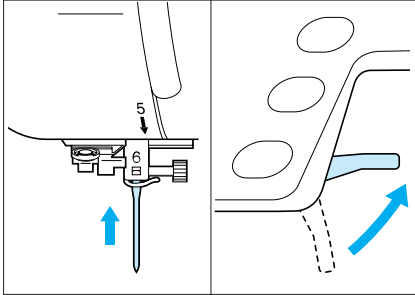

1. Press the "Start/Stop" button to stop the machine.
2. Press the "Needle Position" button to raise the needle, and raise the presser foot lever.
3. If the upper thread is broken, redo the upper threading. If the bobbin thread is broken, follow the directions on page 5-35 to reset the bobbin.

CAUTION

Be careful not to bump the embroidery unit carriage or the presser foot when removing or attaching the embroidery frame. Otherwise, the pattern will not embroider correctly.

4. Press .

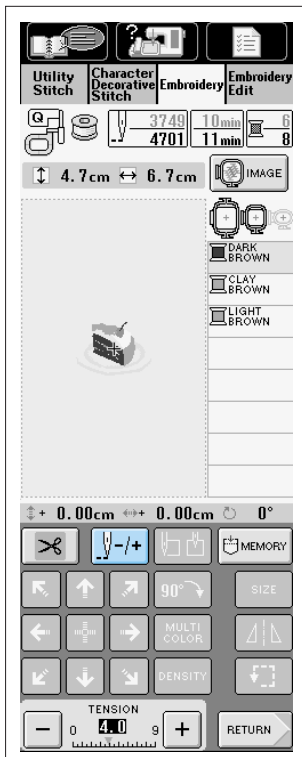

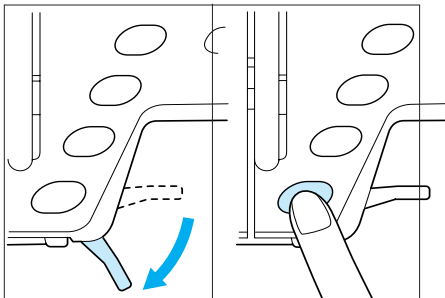
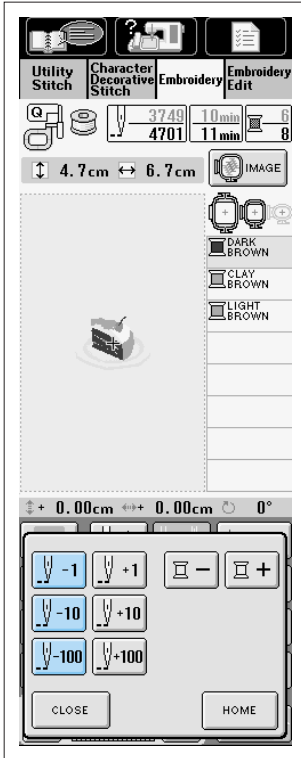

5. Press , , or , to move the needle back 2-3 stitches before the spot where the thread broke.
 - * Press , , or to move the pattern back the number of stitches shown on the key without sewing.
 - * Press , , or to move the pattern forward the number of stitches shown on the key without sewing.
 - * Press to move to the beginning position of the present color (character) without sewing.
 - * Press to move to the beginning position of the next color (character) without sewing.
 - * Press to return to the original screen.

If you can not move back to the spot where the thread broke, press to move to the beginning position of the selected color, then use , , or to move ahead to slightly before where the thread broke.

6. Lower the presser foot lever, and press the "Start/Stop" button to continue sewing.



Sewing Again from the Beginning

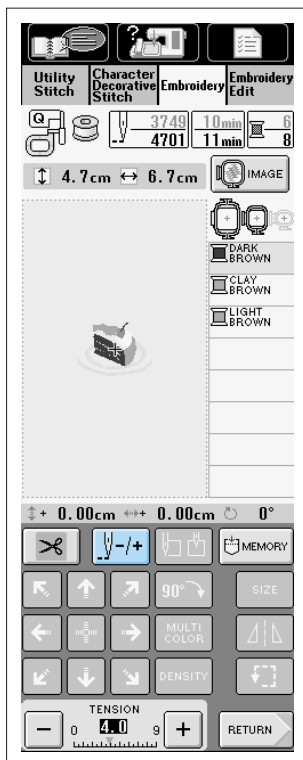

1. Press .

2. Press . The embroidery frame moves, returning the needle to the pattern's beginning position.

3. Lower the presser foot lever and begin sewing.

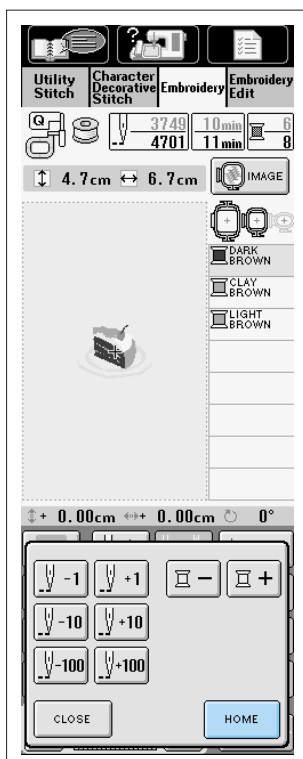

1 —



2 —



3 —



4 —



5 —



6 —



7 —



8 —







9 —

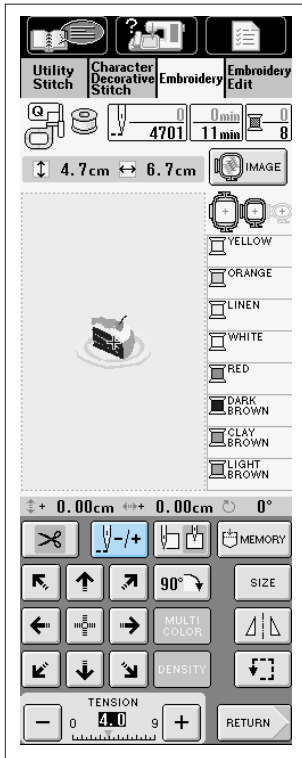

Continuing Embroidery After Turning off the Power







Example: If the power goes off while sewing the second color

1. Select the pattern and press .
2. Press  to move the second color to the first position in the display.
3. Use , , or  to advance the pattern to slightly before where sewing stopped.
4. Lower the presser foot lever and start sewing.

CAUTION

To continue a pattern that has had its position changed (see page 5-26), move the pattern the same amount in the layout display screen, then follow the steps above. In this case, you need to make a note of the pattern's position before turning off the power.

Note

Use the  display to remember the last stitch number sewn before you turn off the power. Then use the , , , or  keys to move the pattern to the same stitch number and continue sewing.

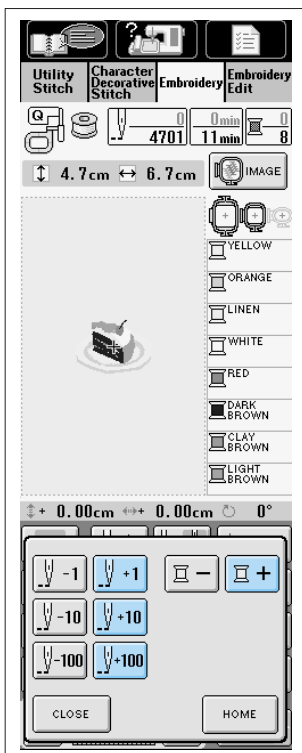

MAKING EMBROIDERY ADJUSTMENTS

Adjusting Thread Tension

When embroidering, the thread tension should be set so that the upper thread can slightly be seen on the wrong side of the fabric.

■ Correct Thread Tension

The pattern can be seen from the wrong side of the fabric.

If the thread tension is not set correctly, the pattern will not finish well. The fabric may pucker or the thread may break.



(right side)



(wrong side)

Follow the operations described below to complete the revisions, according to the situation.

CAUTION

If the thread tension setting is made extremely weak, the machine may stop during sewing. This is not the sign of a malfunction. Increase the thread tension slightly, and begin sewing again.

Note

- If you turn off the power or select a different pattern, the thread tension will reset to the automatic setting.
- When you retrieve a saved pattern, the thread tension setting will be the same as when the pattern was saved.

■ If the Upper Thread Tension is Too Strong

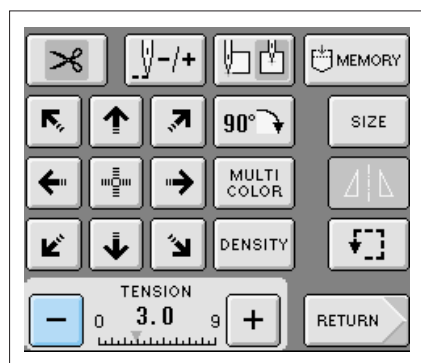

The bobbin thread will show on the right side of the fabric.



(right side)



(wrong side)

Press  to weaken the upper thread tension.



■ If the Upper Thread Tension is Too Weak

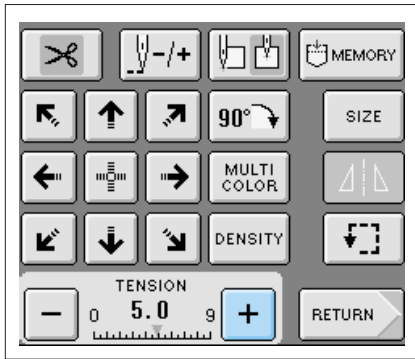

The upper thread will become loose. The embroidery thread on the right side of the fabric will loosen, the thread locks may loosen, or loops may appear on the right side of the fabric.



(right side)





(wrong side)

Press  to increase the thread tension.

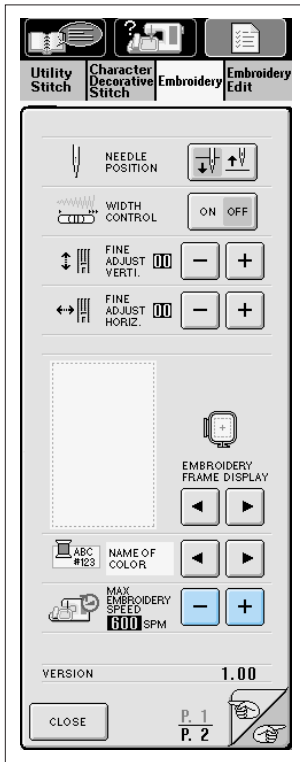
Adjusting the Embroidery Speed



1. Press .

2. In the  display, use the   keys to change the maximum embroidery speed. You can choose from 3 settings.





* SPM is the number of stitches sewn in one minute.

3. When you have selected the speed setting, press

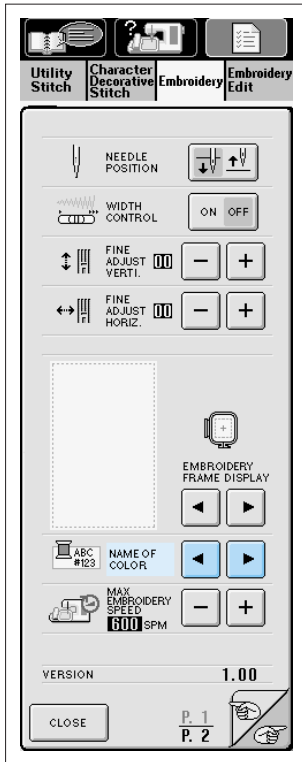
.

Changing the Thread Color Display



1. Press .
2. In the  display, use   to change the thread color display. You can display the name of the thread color, the embroidery thread number, or the time allotted for the embroidery of that thread color.

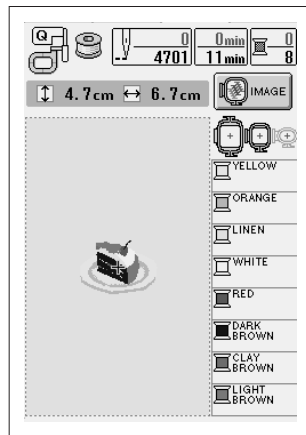

NAME OF COLOR

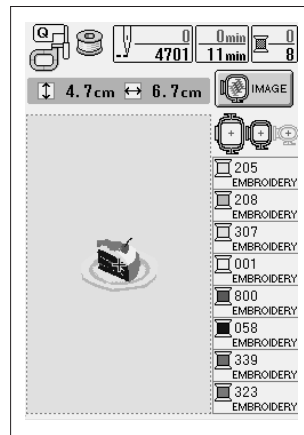

EMBROIDERY THREAD#

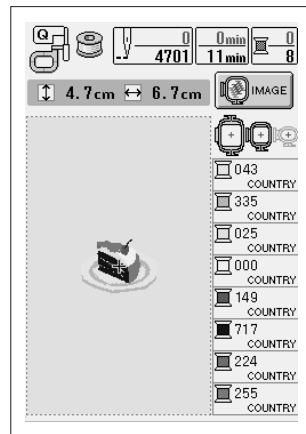

COUNTRY THREAD#

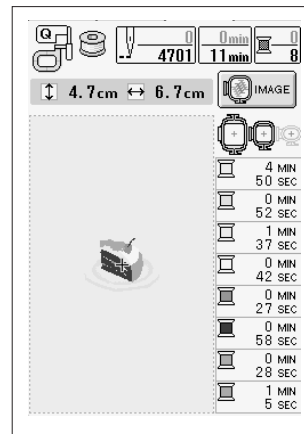

TIME

3. When you have selected the type of display, press .



Changing the Embroidery Frame Display

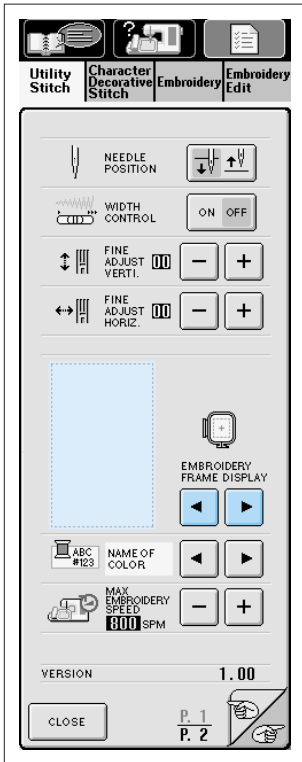

1. Press

2. In the display, use to change the embroidery frame display. You can choose from 8 patterns.

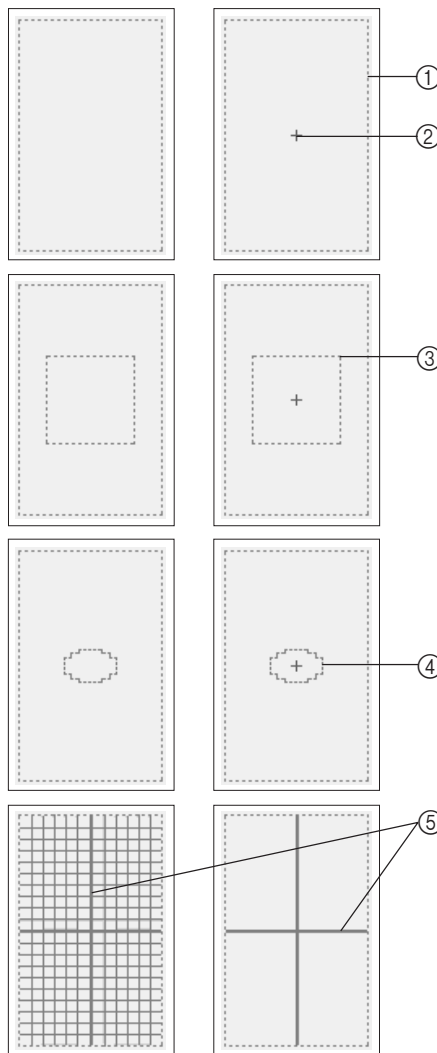

- ① Large frame embroidering area
- ② Center line
- ③ Medium frame embroidering area
- ④ Small frame embroidering area
- ⑤ Grid lines

Example

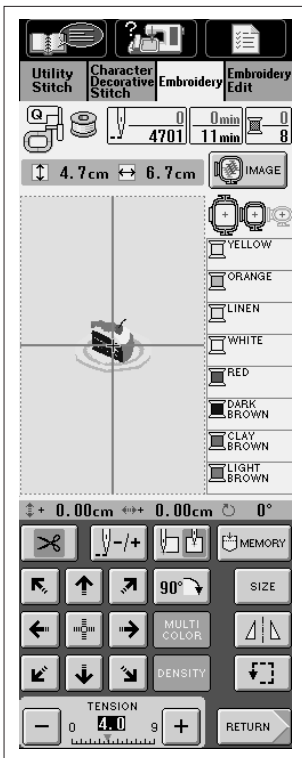

3. When you have finished selecting the embroidery frame display, press .

REVISING THE PATTERN

Using these keys, you can change the size of the pattern, rotate the pattern, etc.

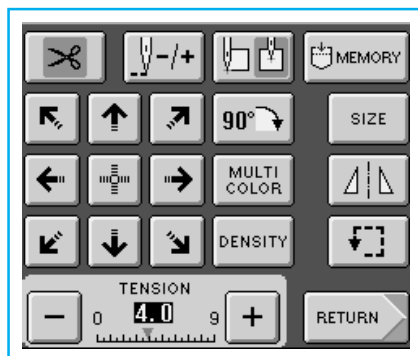

Pattern Revision Keys

CAUTION

If the key display is light gray, that function or operation can not be used with the selected stitch.

■ Key Functions

Key or display	Name	Explanation	Page
	Automatic thread cutting key	For embroidery, the automatic thread cutting function is set automatically. When sewing is finished, the machine will automatically sew reinforcement stitches and trim the threads.	2-15
	Forward/Back key	Moves the needle forward or back in the pattern; useful if the thread breaks while sewing or if you want to start again from the beginning.	5-36
	Starting point key	Moves the needle start position to the bottom left or to the center of the pattern. Use this key to align the needle with the pattern position.	5-55
	Memory key	Saves a pattern in the machine's memory.	5-49
	Arrow keys (Center key)	Press an arrow key to move the pattern in the direction shown by the arrow. (Press the Center key to return the pattern to the center of the embroidery area.)	5-26
	90 degree rotation key	Press this key to rotate the pattern. The pattern rotates 90 degree each time you press the key.	5-46
	Multi color key	Press this key to change the color of each letter when sewing alphabetical character patterns.	5-48
	Density key	Press this key to change the density of character or border patterns.	5-47
	Size key	Press this key to change the size of the pattern.	5-45
	Horizontal mirror image Key	Press this key to create a horizontal mirror image of the pattern.	5-46
	Trial key	Press this key to check the position of the pattern. The embroidery frame moves to check that there is enough space to sew the pattern.	5-27
	Thread tension key	Shows the thread tension for the selected pattern. The tension is normally set automatically.	5-40
	Return key	Press this key to return to the pattern type selection screen.	—

Changing the Size of the Pattern

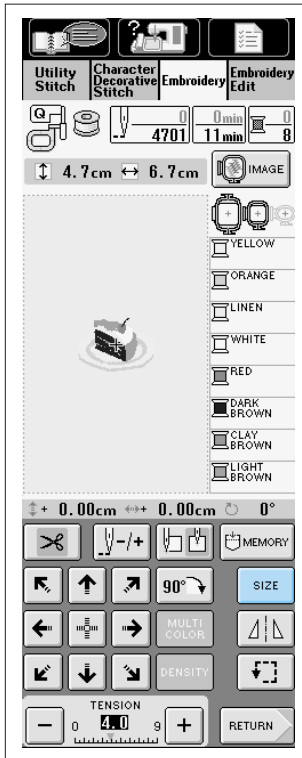

1. Press **SIZE**.

2. The screen at the left is displayed.

Press  to make the pattern smaller.

Press  to make the pattern bigger.

The size changes each time you press the key.

Press **RESET** to return the pattern to the original size.

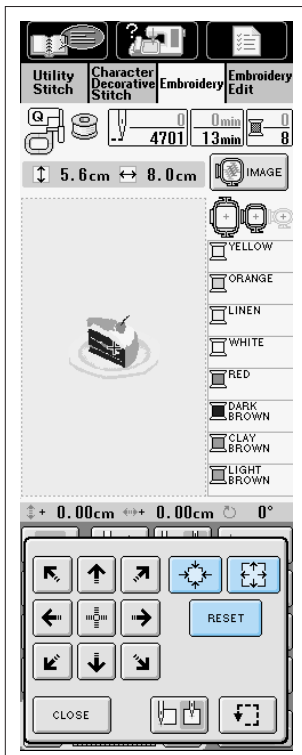

- * Some patterns or characters can be enlarged more than others.
- * Some patterns or characters can be enlarged to a greater degree if they are rotated 90 degrees.

CAUTION

When you have changed the size of the pattern, check the display of available embroidery frames and use an appropriate frame. If you use an embroidery frame not displayed as available for use, the presser foot may strike the frame and cause injury.

3. Press **CLOSE** to return to the original screen.

Rotating the Pattern

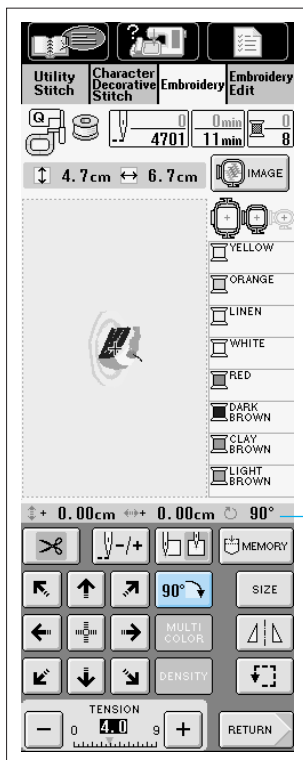

Press to rotate the pattern 90 deg.

① Shows the degree of the pattern's rotation.



0°



90°

⚠ CAUTION

When you have rotated the pattern, check the display of available embroidery frames and use an appropriate frame. If you use an embroidery frame not displayed as available for use, the presser foot may strike the frame and cause injury.

①

Creating a Horizontal Mirror Image

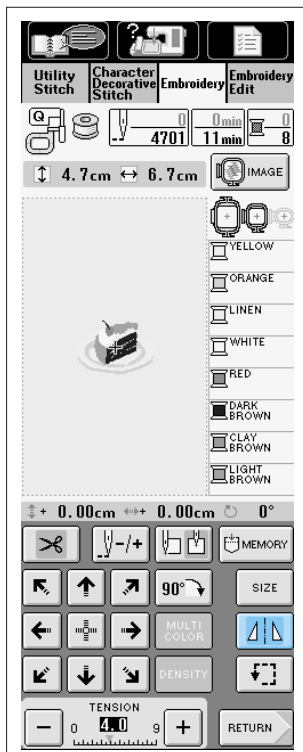

Press so it appears as to create a horizontal mirror image of the selected pattern.

Press again to return the pattern to normal.



Changing the Density of a Pattern (Character and Border Patterns Only)

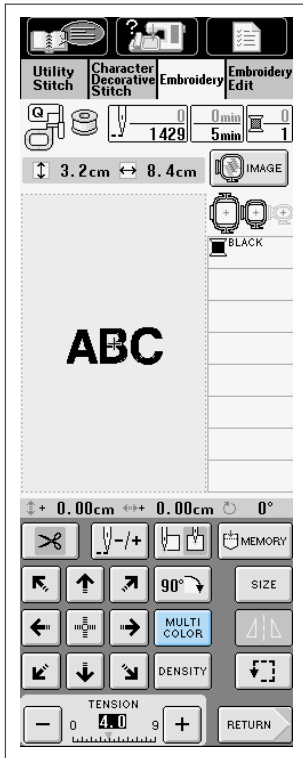

1. Press **DENSITY**.

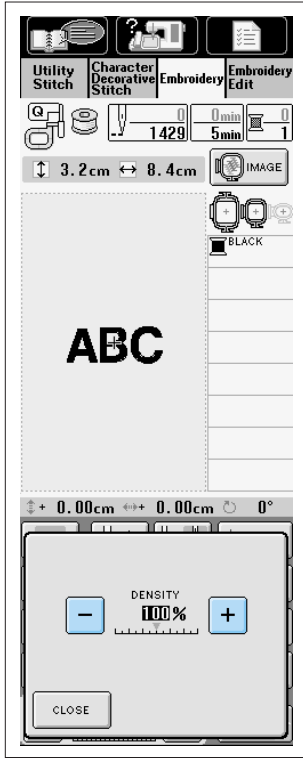

2. The screen at left is displayed.

Press **-** to make the pattern less dense.

Press **+** to make the pattern more dense. The pattern density changes each time you press a button.

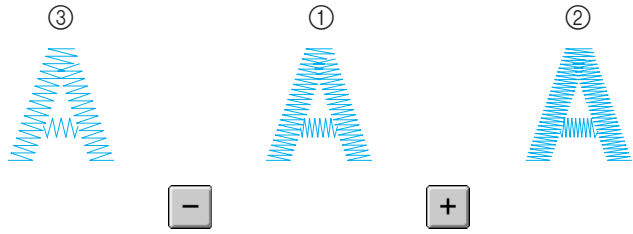

- ① Normal
- ② Fine (stitches closer together). Stitch count is a larger number.
- ③ Coarse (stitches farther apart). Stitch count is a smaller number.

3. Press **CLOSE** to return to the pattern selection screen.

Changing the Colors of Character Patterns

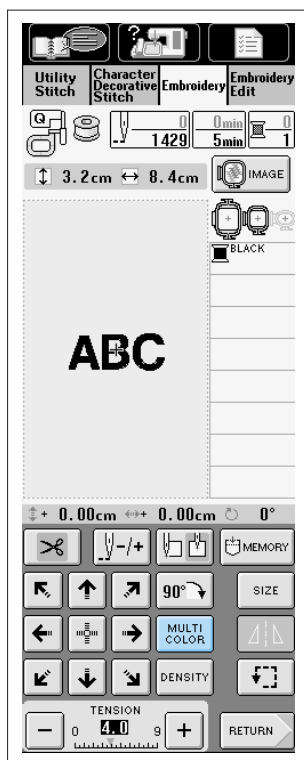

Press **MULTI COLOR** so that it appears as **MULTI COLOR**. The machine will stop after sewing each character, so you can change the color of each character. Press the key again to return to the original setting.

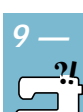
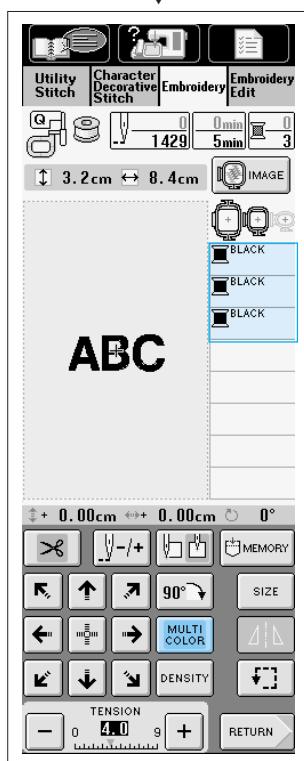

MEMORY FUNCTION

Saving Embroidery Patterns

You can save embroidery patterns that you have customized and will use often; for example, your name or other combined character patterns, patterns that have been rotated or had the size changed, patterns that have had the sewing position changed, etc.

■ Saving a Pattern

1. Press .

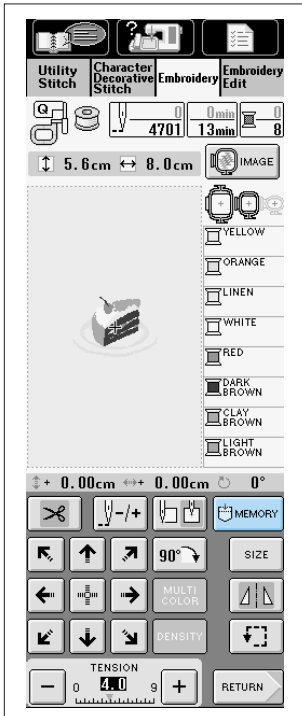

2. Choose where to save the pattern.

Press  to save the pattern in the machine's memory.

If you have the proper floppy disks, after inserting a floppy disk you can press  to save the pattern to a floppy disk.

Note

- If your machine did not come furnished with a built-in floppy disk drive, you can receive an upgrade service for your machine, so that it can use floppy disks at your authorized dealer.
- Floppy disks are 2HD type. Be sure to use formatted disks.
- Move the write protect switch on the floppy disk to the unprotected position before using the disk.
- When you save to a floppy disk the design will be saved in a special sewing machine format. The design will have a ".phc" extension after its name.

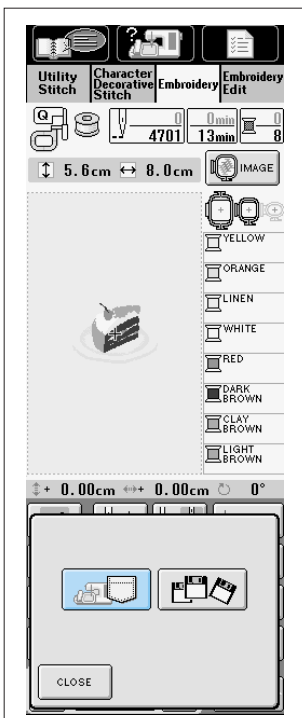

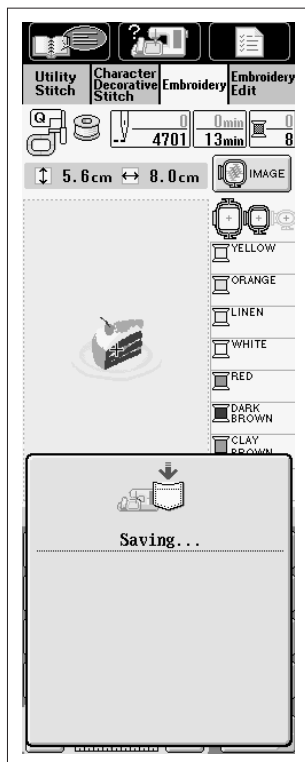

- The "Saving" screen displays. When the pattern is saved, the display returns to the original screen automatically.

CAUTION

Do not turn off the power while the "Saving" screen is displayed. You will lose the pattern you are saving. Also, do not remove the floppy disk while the pattern is being saved. The disk may become unreadable.

Note

It takes about 10 seconds to save a pattern to the machine's memory.

See page 5-53 for information on retrieving a saved pattern.

■ If You Can Not Save the Pattern

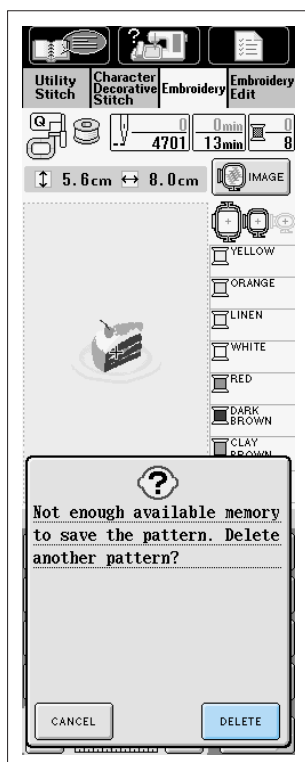

If the screen at left displays, the maximum number of patterns have been saved, or the pattern you want to save takes a lot of memory, and the machine can not save it. If you delete a previously saved pattern, you can save the current pattern.

- * If you decide not to save the current pattern, press .

Deleting a Previously Saved Pattern

- Press .
- The machine displays the patterns currently saved.

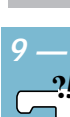

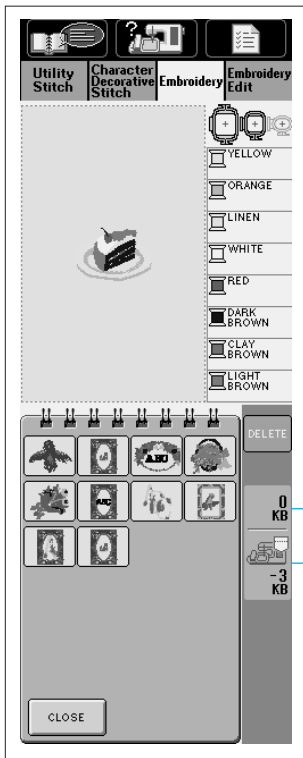

3. Select the pattern you want to delete.

- ① Shows the amount of memory used by the pattern selected to be deleted.
- ② Shows the amount of memory needed to save the current pattern.

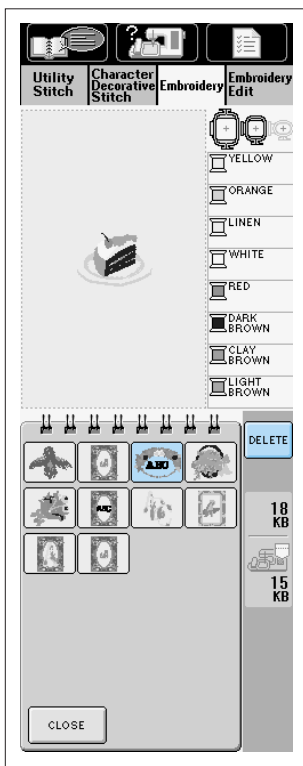

4. Press **DELETE**.

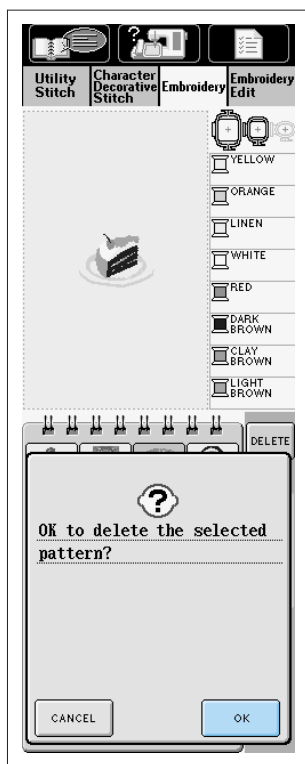

5. Press **OK** to delete the selected pattern.

* If you decide not to delete the pattern, press **CANCEL**.

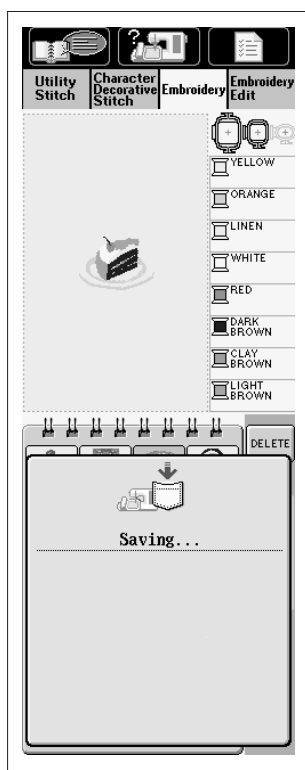

6. If there is enough memory available after deleting the pattern, the pattern you want to save will be saved automatically. If there is not enough memory available after deleting the pattern, repeat the steps above to delete another pattern from the machine's memory.

The display will automatically return to the original screen after saving the pattern.

CAUTION

Do not turn off the power while the "Saving" screen is displayed. You will lose the pattern you are saving.

Note

It takes about 10 seconds to save a pattern.

See page 5-53 for more information about retrieving saved patterns.

Retrieving Patterns from Memory

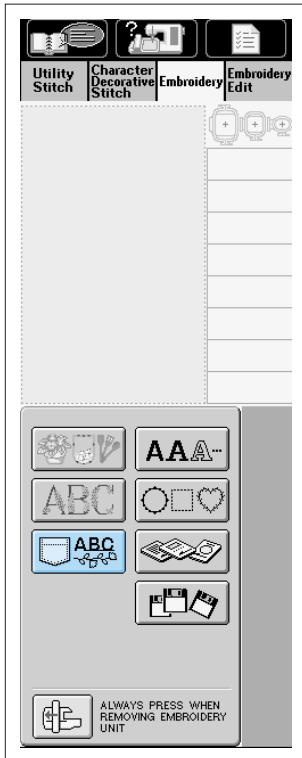

1. Press .

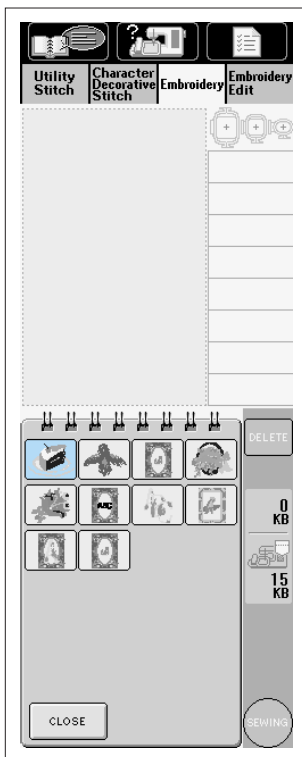

2. The machine displays the patterns currently in the memory. Press the key of the pattern you want to sew.

1 —



2 —



3 —



4 —



5 —



6 —



7 —



8 —



9 —

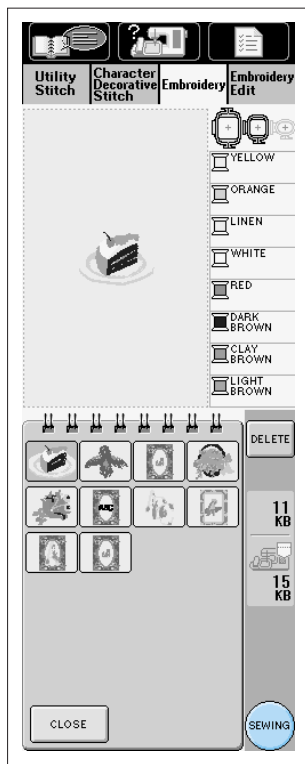

3. Press .

* If you decide not to retrieve the pattern from memory, press . The machine returns to the original screen.

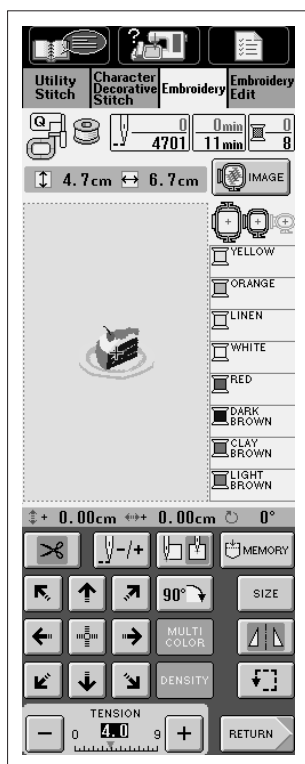

4. The machine retrieves the pattern and prepares to embroider it.

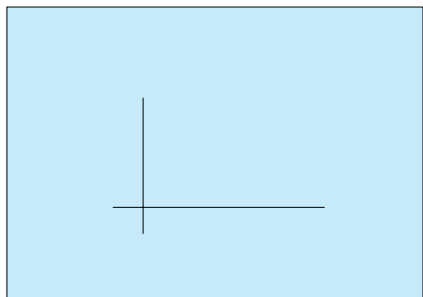

EMBROIDERY APPLICATIONS

Aligning the Left Side of a Pattern and Sewing



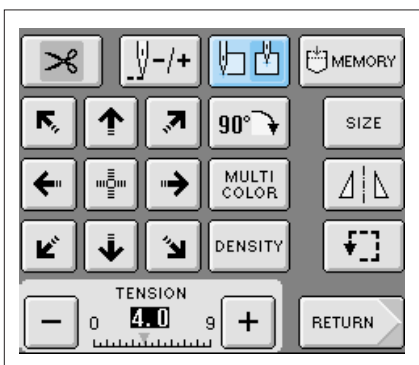

1. Mark the embroidery start position on the fabric, as shown.

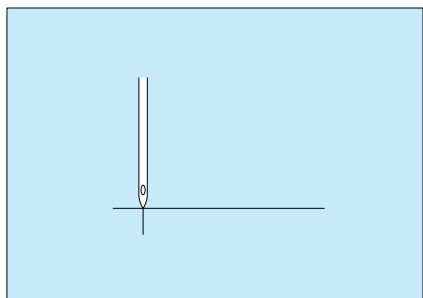

2. Press  so it appears as .

The needle position moves to the bottom left corner of the pattern (the embroidery frame moves so that the needle is positioned correctly).



3. Use  to align the needle and the mark on the fabric, and begin embroidering the pattern.

▲ CAUTION

Do not lower the needle while the embroidery frame is moving. Otherwise, injury may result.

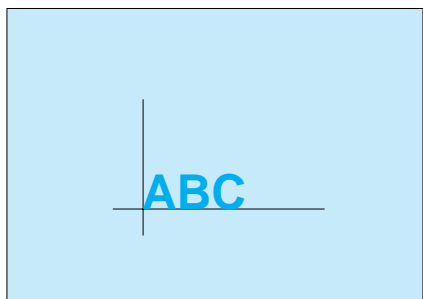

4. View of the finished pattern.







Connecting Characters

Follow the steps below when all the characters in the pattern do not fit in the embroidery frame at once.

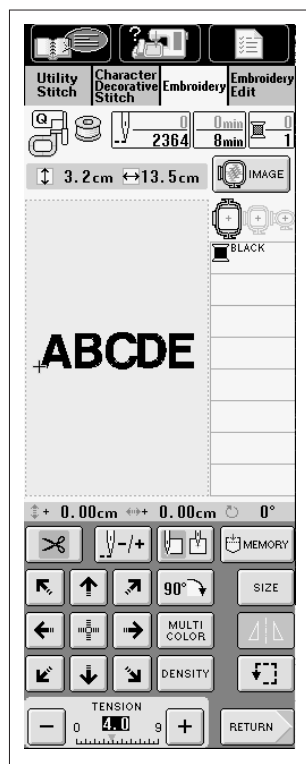
Example: Connecting the letters "ABCDE" with "FGHI"

A B C D E F G H I



1. Enter the letters "ABCDE."
2. Press  to move the needle start position to .
3. Press  to turn off automatic thread cutting.

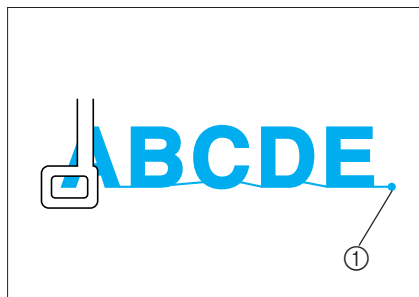

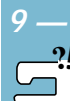

4. Press the "Start/Stop" button to begin sewing.
5. When sewing is finished, trim the thread, leaving a long end. Then re-insert the fabric in the embroidery frame, in a position where you can sew the letters "FGHI."

① The embroidery end position

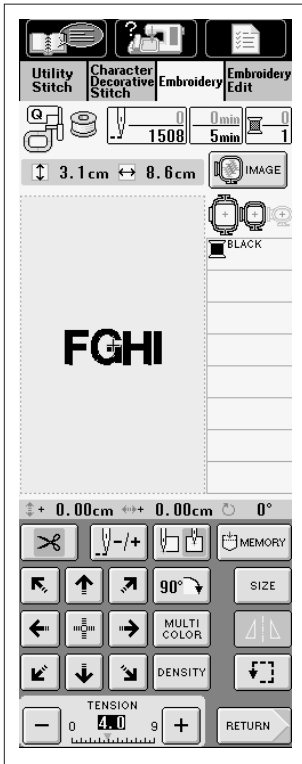



6. Enter the letters "FGHI."

7. Press  to move the needle start position to . The needle start position moves to the bottom left corner of the pattern.

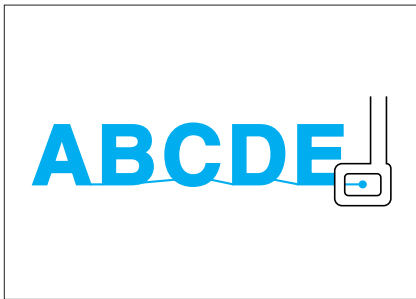

8. Use the arrow keys  to move the needle to the position where the previous pattern stopped.



9. Press the "Start/Stop" button to embroider the remaining letters.

1 —



2 —



3 —



4 —



5 —



6 —



7 —



8 —



9 —



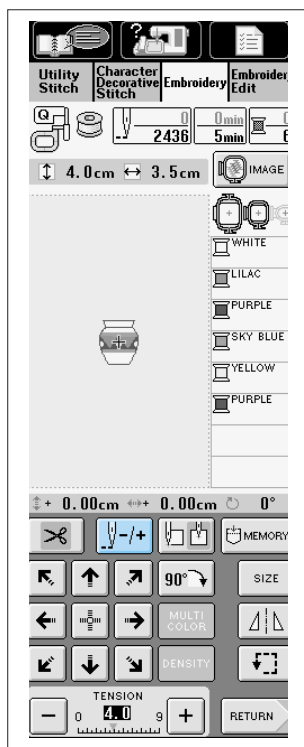

Embroidering an Outline of a Pattern

You can embroider the outline of a pattern to create different finishes.

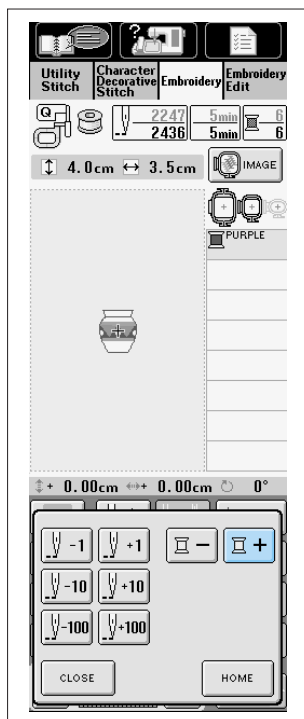

1. Press .



2. Press  to advance the sewing order to the color of the outline.
3. Lower the presser foot and start sewing.

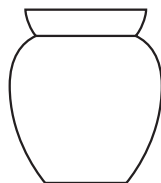

1 —



2 —



3 —



4 —



5 —



6 —



7 —



8 —



9 —



Using a Frame Pattern to Make Appliqué (1)

You can use framed patterns of the same size and shape, to create an appliqué. Embroider one pattern with a straight stitch and one pattern with a satin stitch.

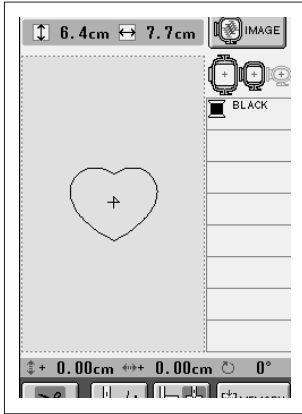

1. Select a straight stitch frame pattern. Embroider the pattern onto the appliqué material, then cut neatly around the outside of the shape.

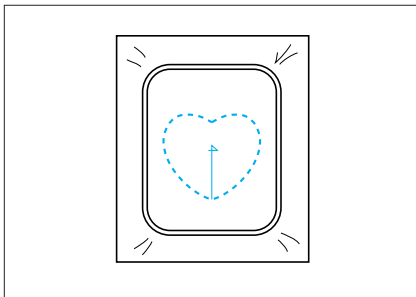
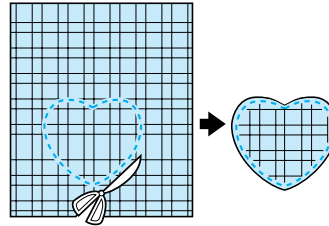

2. Embroider the same pattern from step 1 onto the base fabric.

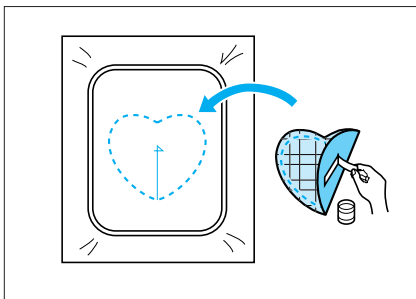

3. Apply a thin layer of fabric glue or a temporary spray adhesive to the rear of the appliqué created in step 1. Attach the appliqué to the base fabric matching the shapes.

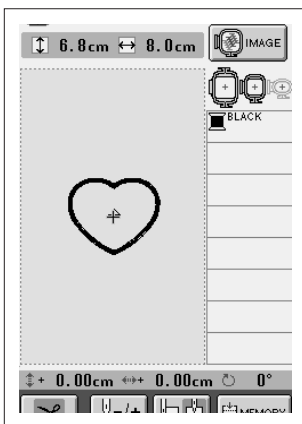

4. Select the satin stitch frame pattern of the same shape as the appliqué. Embroider over the appliqué and base fabric from step 3 to create the appliqué.

CAUTION

If you change the size or position of the patterns when selecting them, make a note of the size and location.

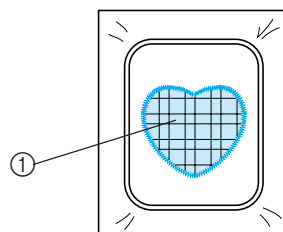

① Appliqué material

Using a Frame Pattern to Make Appliqué (2)

A second method to make appliqué using the embroidery patterns. You do not have to change the fabric in the embroidery frame using this method. Embroider one pattern with a straight stitch and one pattern with a satin stitch.

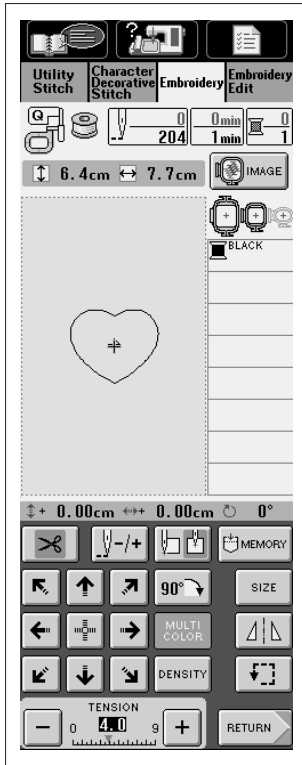

1. Select a straight stitch frame pattern, and embroider the pattern onto the base fabric.

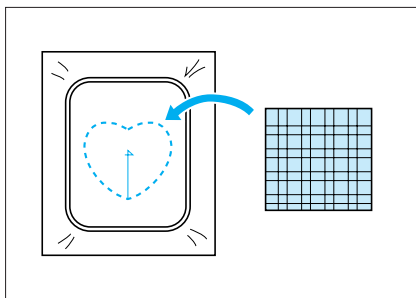
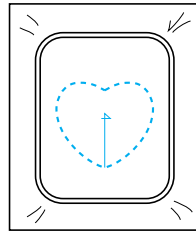

2. Place the appliqué fabric over the pattern embroidered in step 1. Be sure that the appliqué fabric completely covers the seam.

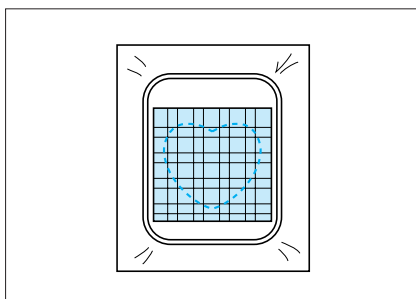

3. Embroider the same pattern on the appliqué fabric.
* Stop the machine before it sews the cross hairs in the middle of the pattern.



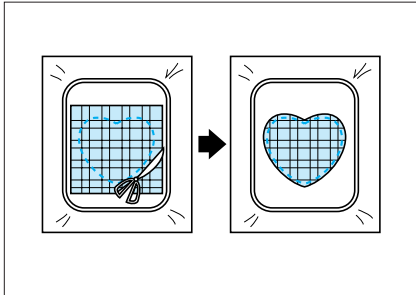

- Remove the embroidery frame from the embroidery unit, and cut around the outside of the stitches.

CAUTION

Do not remove the fabric from the embroidery frame to cut. Also, do not pull strongly on the fabric. Otherwise, the fabric may loosen in the frame.

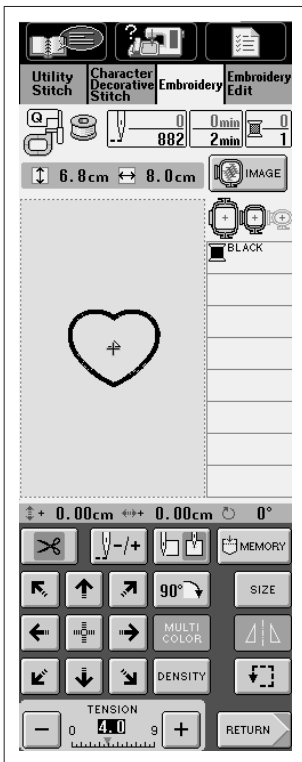

- Select the satin stitch border pattern of the same shape as the appliqué.

CAUTION

Do not change the size or position of the pattern.

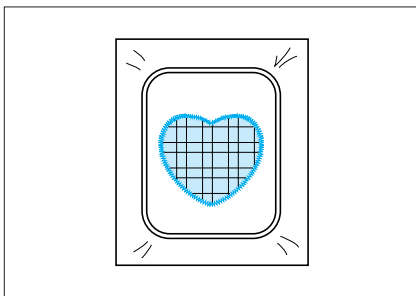

- Reattach the embroidery frame to the embroidery unit, and embroider the satin stitch pattern to create an appliqué.

Embroidering Small Fabrics or Fabric Edges

Use an embroidery stabilizer material to provide extra support. After embroidering, remove the stabilizer fabric carefully. Attach the stabilizer as shown in the examples below. We recommend using a stabilizer material for embroidery.

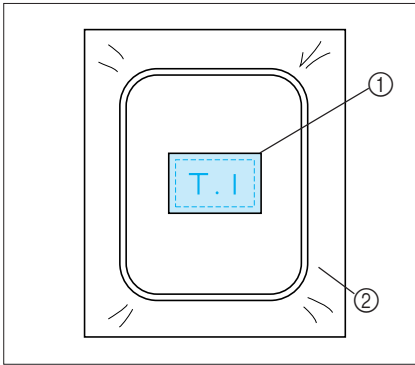

Embroidering Small Fabrics

① Fabric

Use a temporary spray adhesive to adhere the small piece of fabric to the larger piece in the frame.

If you do not wish to use a temporary spray adhesive, attach the stabilizer fabric with a basting stitch.

② Stabilizer

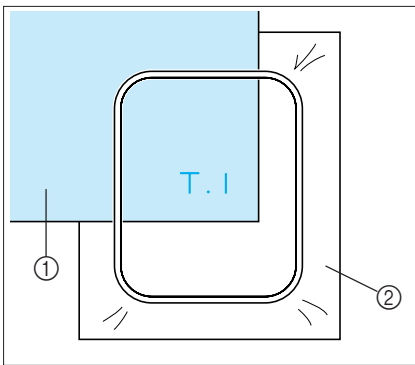

Embroidering Edges or Corners

① Fabric

Use a temporary spray adhesive to adhere the small piece of fabric to the larger piece in the frame.

If you do not wish to use a temporary spray adhesive, attach the stabilizer fabric with a basting stitch.

② Stabilizer

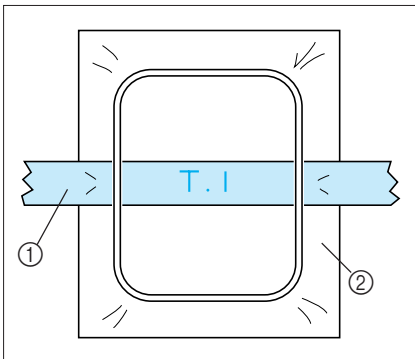

Embroidering Ribbons or Tape

① Ribbon

Secure with double-sided tape or a temporary spray adhesive.

② Stabilizer



Chapter 6 Embroidery Edit Functions

EXPLANATION OF THE EDITING FUNCTIONS

With the Embroidery Edit functions, you can combine embroidery patterns and character patterns, change the size of patterns, rotate patterns, and perform many other editing functions. This machine can perform the 8 functions listed below.

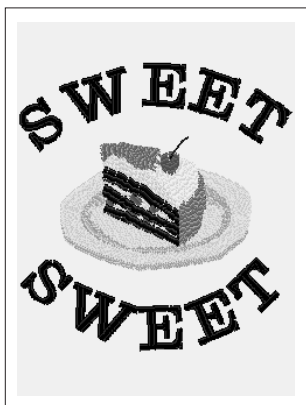
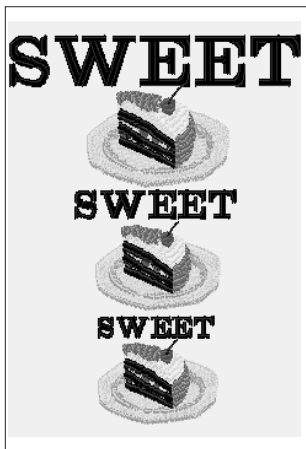

Combine Patterns

You can easily create combinations of one point patterns, frame patterns, character patterns, patterns from the machine memory, patterns from the separately sold embroidery cards, and many other patterns.

Move Patterns

Within the 26 cm × 16 cm (10-1/4 inch × 6-1/4 inch) wide embroidery area, you can change the position of patterns, and check the position on the LCD.

Rotate Patterns

You can rotate patterns one degree or ninety degrees at a time.

Enlarge or Reduce Patterns

You can make patterns larger or smaller. There are approximately 50 sizes to choose from.

* This function is not available for some patterns.

Create Mirror Images

You can create horizontal mirror images.

* This function is not available for some patterns.

Change Character Spacing

You can increase or decrease the space between characters in combined patterns.

Change Character Appearance/Layout

You can change the layout of the characters. Print words on a curved line, diagonal, etc. There are 6 choices total.

Change the Thread Colors of Patterns

You can change the thread colors of the pattern to your favorite colors.



SELECTING PATTERNS TO EDIT

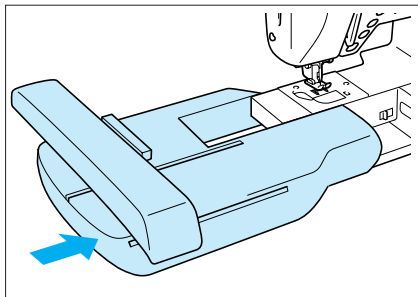

1. Attach the embroidery unit, and prepare the machine for embroidery (see page 5-5).

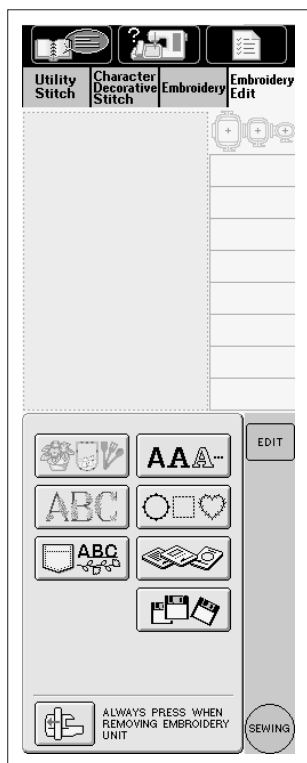

2. Press **Embroidery Edit** to call the screen at the left.

Key Display	Pattern Type
	One point pattern
	Floral alphabet pattern
	Pattern saved in the machine's memory
	Character pattern
	Frame pattern
	Pattern from an embroidery card (sold separately)
	Pattern from a floppy disk

Note

If your machine did not come furnished with a built-in floppy disk drive, you can receive an upgrade service for your machine, so that it can use floppy disk at your authorized dealer.

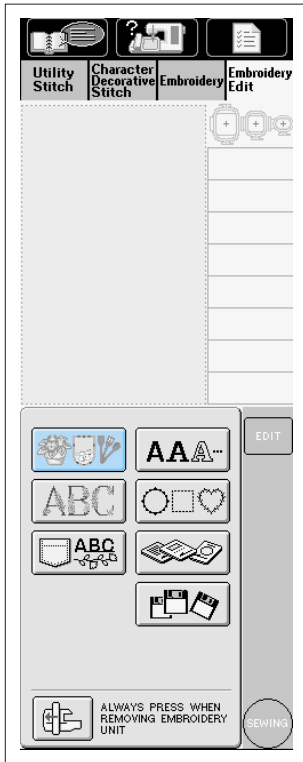

The method of selecting patterns without alphabetical characters is the same as selecting patterns for embroidery.

1. Select the type of pattern you want to sew.

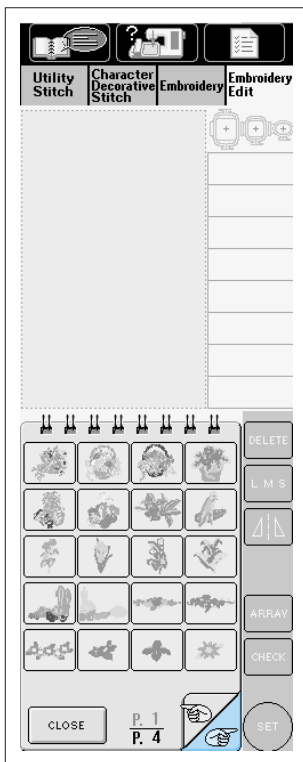

2. Press the key of a pattern to select it.

* See page 5-8 for more information on selecting patterns.

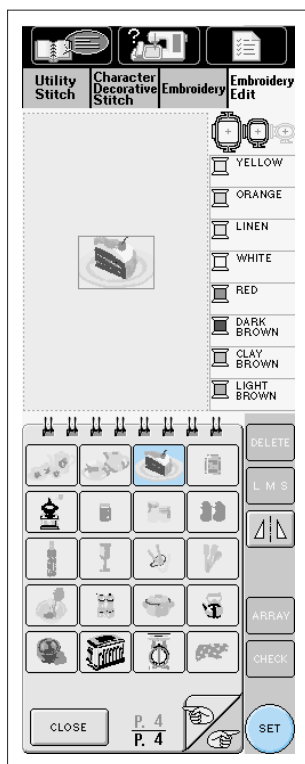

3. The pattern is displayed in the top part of the screen.

4. After the pattern is selected, press .

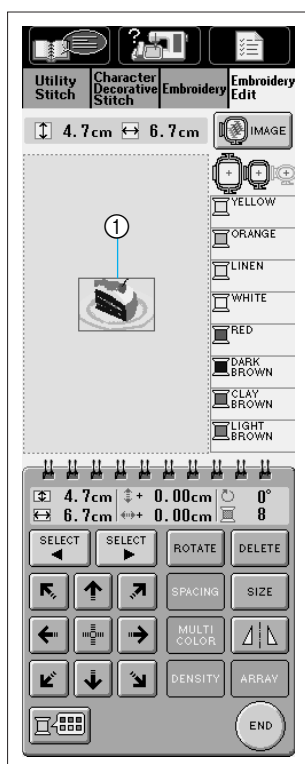

5. The embroidery edit screen (at left) will appear.

* See page 6-8 for more information about editing the pattern.

- ① The pattern selected for editing is outlined in red on the embroidery edit display.

Selecting Character Patterns

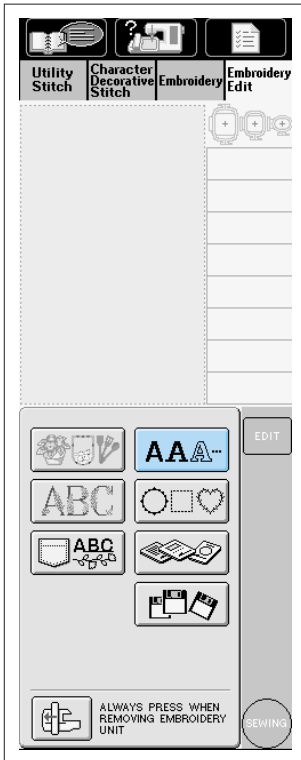

When you select character patterns from the embroidery edit screen, you can edit the appearance of the pattern at the same time.

1. Press **AAA** to select character patterns.

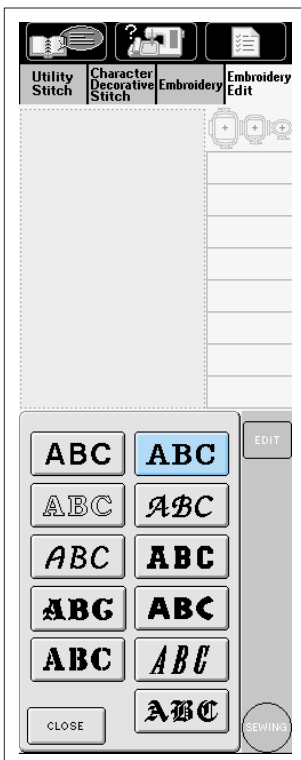

2. Select the font.

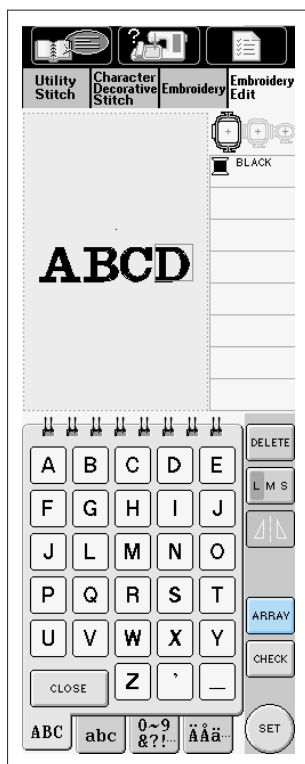

3. Enter the letters (Example: A B C D)

* See page 5-11 for more information about selecting characters

* Press **CHECK** to check the pattern when the selected characters are too small to see clearly.

4. Press **ARRAY** to select the appearance of the pattern.

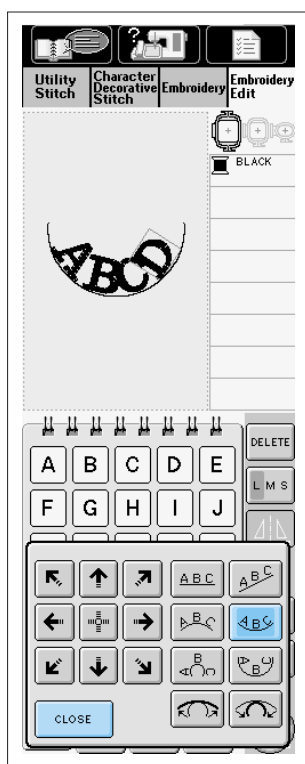

5. The screen at left displays.

Select the appearance you want to use (Example: **ABC**).

After selecting the curve, use  and  to change the degree of the arc.

* Press  to make the arc flatter.

* Press  to make the arc rounder.

6. Press **CLOSE** to return to the original screen.

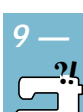

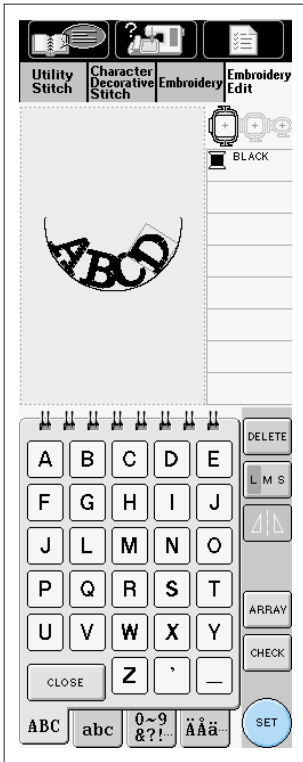

7. After you finish your selections, press .

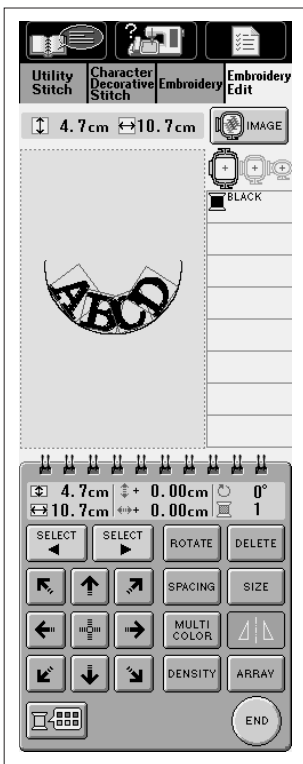

8. The embroidery edit screen will appear. See page 6-8 for more information about editing the patterns.

EDITING EMBROIDERY PATTERNS

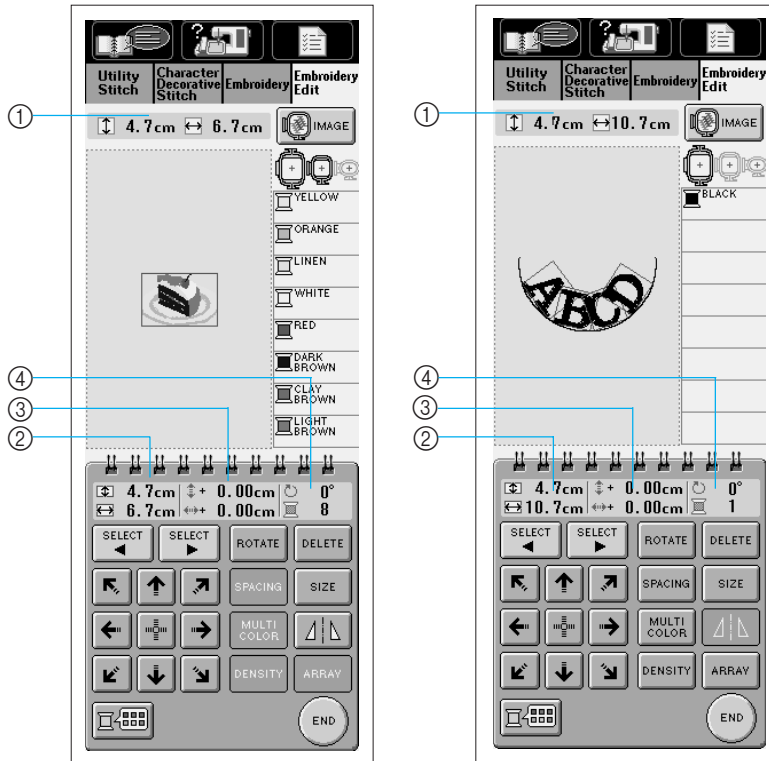

- ① Shows the size of the entire combined pattern.
- ② Shows the size of the pattern currently selected.
- ③ If the pattern location has been moved, this area shows the distance from the center of the frame.
- ④ Shows the degree of rotation for the pattern. Shows the color currently selected, and number of colors in the pattern.

Note
If a key display is light gray, you can not use that function with the selected pattern.

Key Functions

Key or Display	Name	Explanation	Page
	Pattern select key	When a combined pattern is selected, use these keys to select a part of the pattern to edit.	6-26
	Rotate key	Press this key to rotate the pattern. In the embroidery edit screen, you can rotate a pattern one degree or ninety degrees at a time.	6-10
	Delete key	Press this key to delete the selected pattern (the pattern outlined by the red box).	6-12
	Arrow keys (Center key)	Press these keys to move the pattern in the direction indicated by the arrow in the key. (Press to return the pattern to its original position.)	6-9
	Character spacing key	Press this key to change the spacing of character patterns.	6-16
	Size key	Press this key to change the size of the pattern. With the embroidery edit functions, patterns can be enlarged or reduced.	6-11
	Multi color key	Press this key to change the color of individual characters in a pattern.	6-17
	Horizontal mirror image key	Press this key to make a horizontal mirror image of the selected pattern.	5-46
	Density key	Press this key to change the density of frame patterns or character patterns.	5-47
	Array key	Press this key to change the configuration of a character pattern.	6-15
	Thread palette key	Press this key to change the colors of the displayed pattern.	6-13
	End key	Press this key to continue to the next step.	6-18

Moving the Pattern

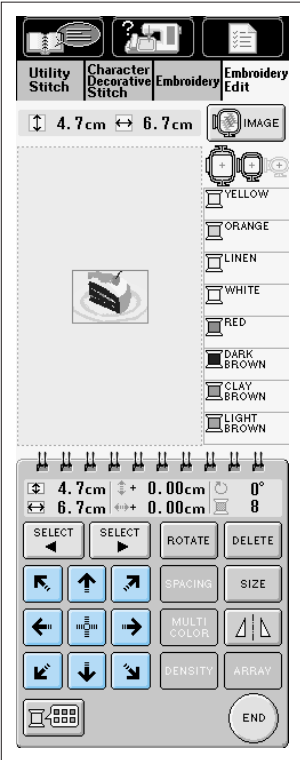

Press to move the pattern in the position shown on the key.

Press to return the pattern to its original position.

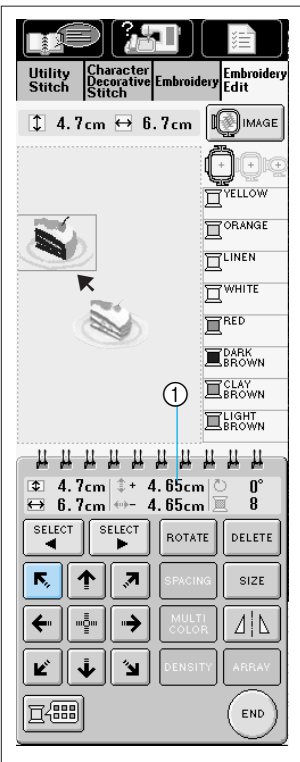

① Shows how far from the original position the pattern is now.



Rotating the Pattern

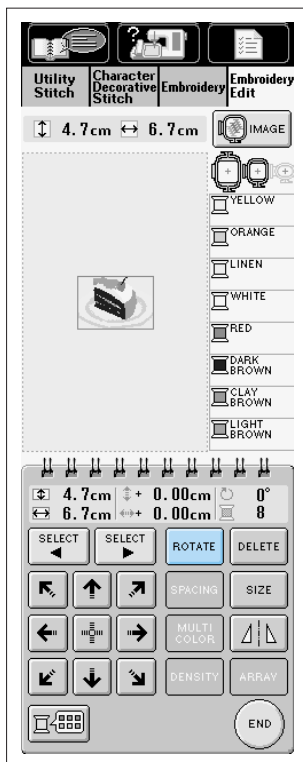

1. Press **ROTATE**.

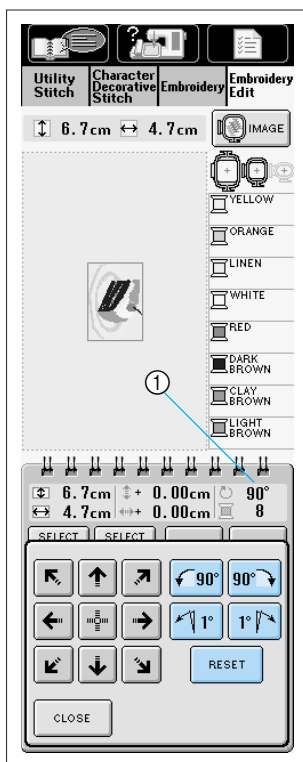

2. Press **90°** to rotate the pattern 90 deg. to the left.

Press **90°** to rotate the pattern 90 deg. to the right.

Press **1°** to rotate the pattern 1 deg. to the left.

Press **1°** to rotate the pattern 1 deg. to the right.

Press **RESET** to return the pattern to its original position.

① Shows the degree of the pattern's rotation

3. After changing the pattern, press **CLOSE**.

Changing the Size of the Pattern

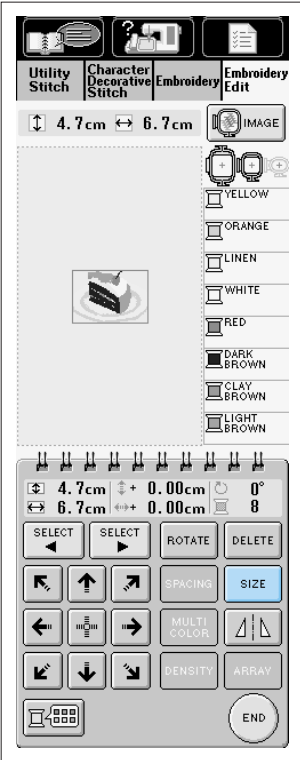

1. Press **SIZE**.

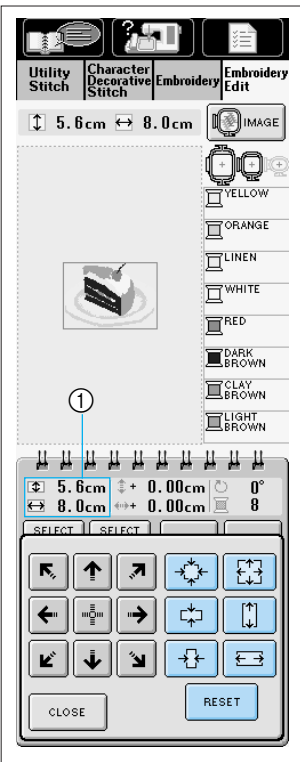

2. Press to enlarge the pattern.

Press to shrink the pattern.

Press to stretch the pattern horizontally.

Press to compact the pattern horizontally.

Press to stretch the pattern vertically.

Press to compact the pattern vertically.

Press **RESET** to return the pattern to its original appearance.

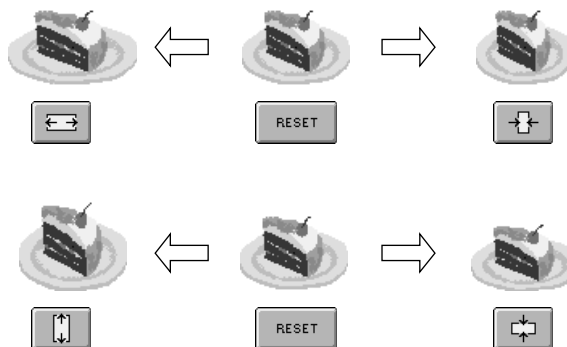

① Shows the size of the pattern being edited.

3. After changing the pattern's size, press **CLOSE**.

Deleting the Pattern

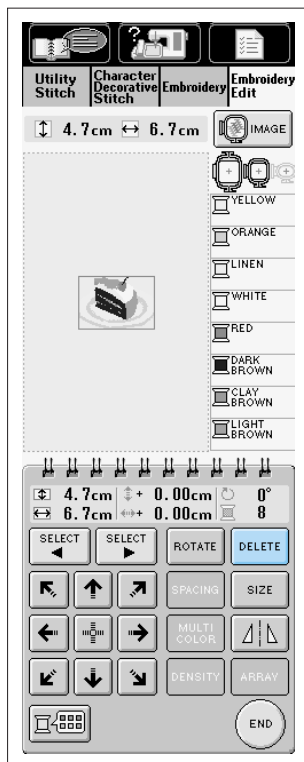

1. Press **DELETE**.

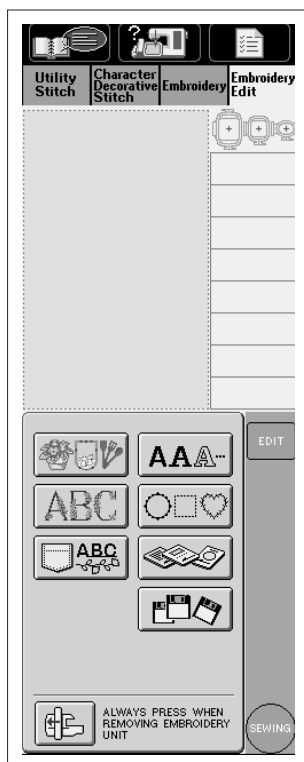

2. The pattern is deleted from the screen.

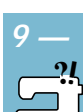

Changing the Thread Color

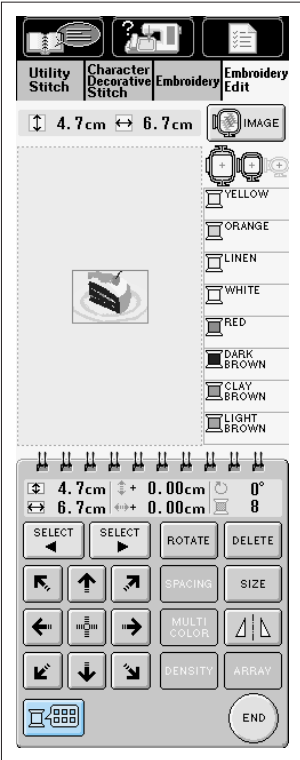

1. Press .

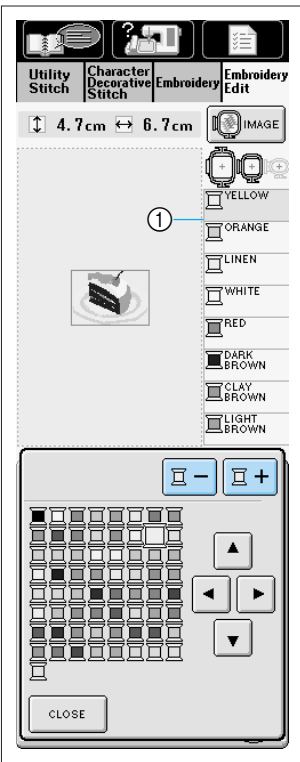

2. The thread color palette screen displays. There are 61 colors to choose from.

3. Press to change the sewing order of the colors. Put the color you want to change at the top of the display.

① You can change the color at the top of the display.

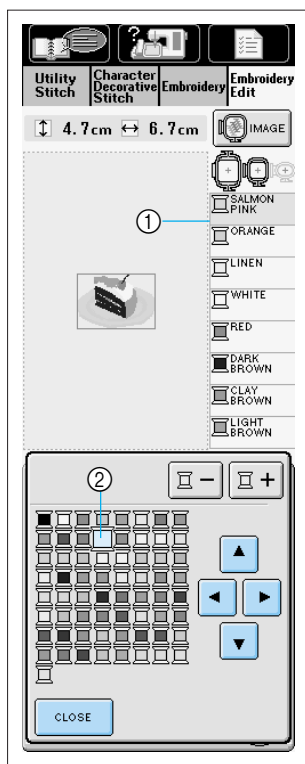
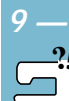

4. Press  to choose a new color on the color palette.

- ① The color on top changes to the selected color.
- ② The thread spool display of the selected color is larger.

5. After changing the colors, press .

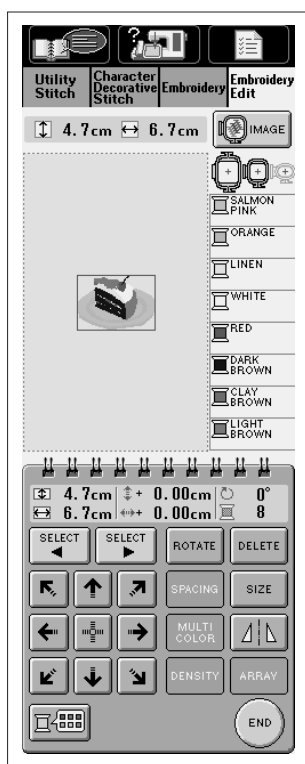

6. The display shows the changed colors.

Changing the Configuration of Character Patterns

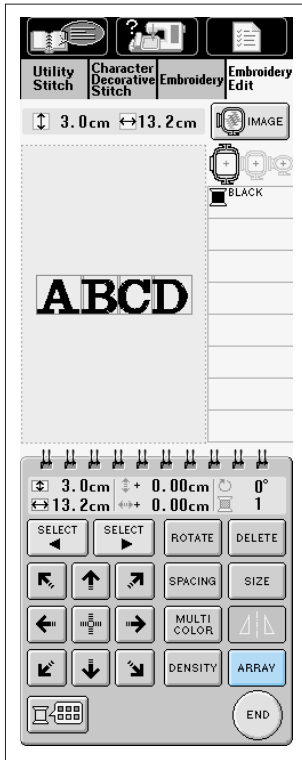

1. Press **ARRAY**.

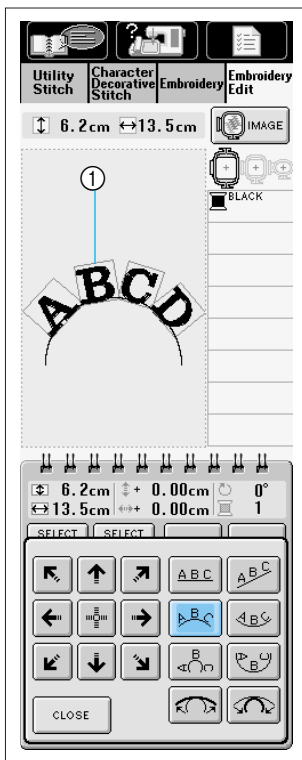

2. Press the key of the layout you want to sew.

① The display will show the selected layout.

3. After making your selections, press **CLOSE**.

Changing Character Spacing

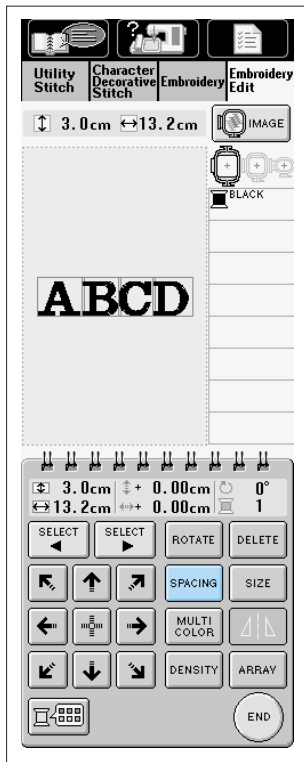

1. Press **SPACING**.

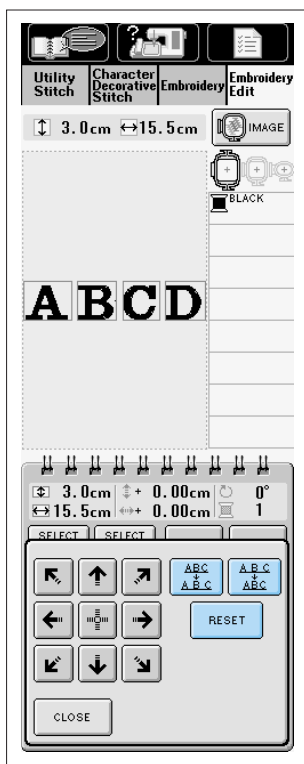

2. Press **ABC / ABC** to widen the character spacing.

Press **ABC / ABC** to compact the character spacing.

Press **RESET** to return the pattern to its original appearance.

A B C D ↔ **ABCD**



3. When finished changing the appearance, press **CLOSE**.

1 —



2 —



3 —



4 —



5 —



6 —



7 —



8 —



9 —



Changing the Color of Each Character in a Pattern

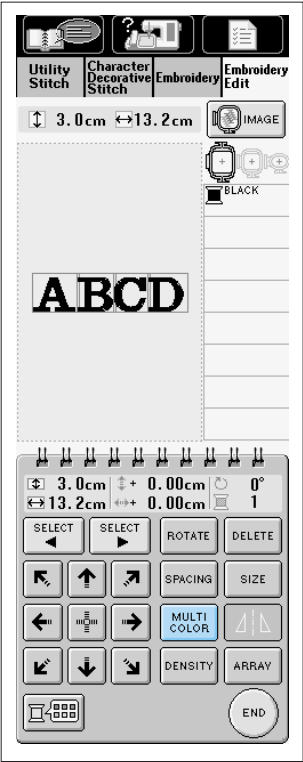

1. Press .

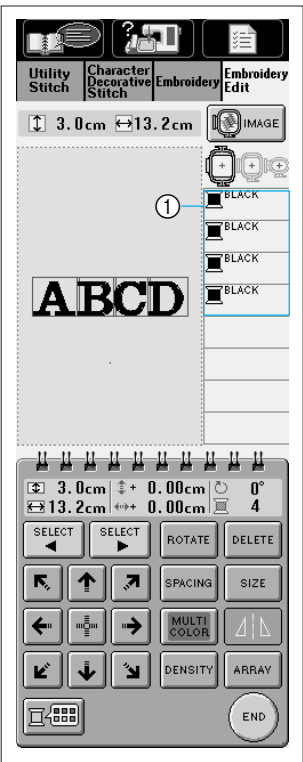

2. You can sew each character in a different color. The screen automatically displays each color as "Black."

* Press to change the color of the pattern (see page 6-13).
 ① The color of each character is displayed.

ADJUSTING PATTERNS AFTER EDITING

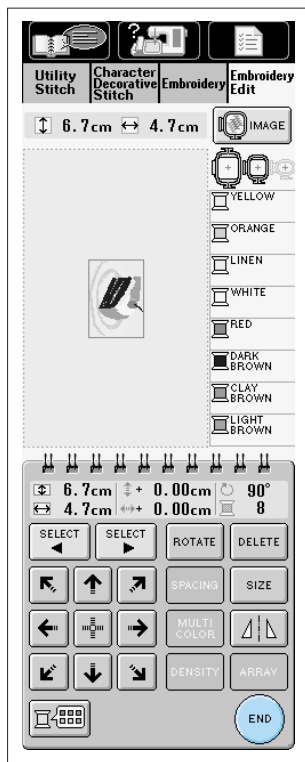
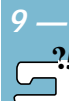

1. Press **END**.

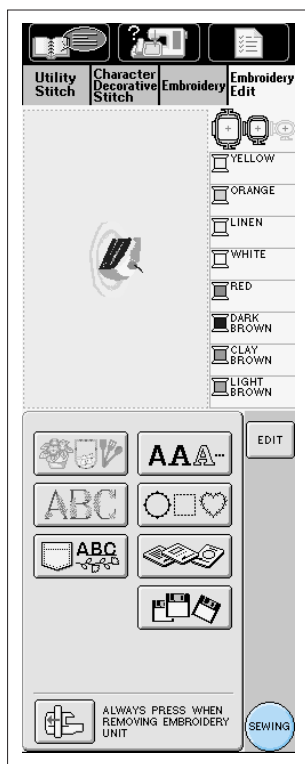

2. If you plan to sew the pattern at that time, press **SEWING** to call the pattern preview screen.

* Press **EDIT** to return to the embroidery edit screen.

* To combine the pattern with other patterns, select the next pattern from this screen (see page 6-20).

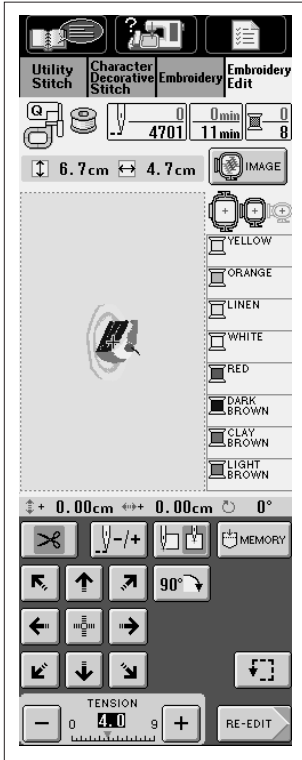

3. See page 5-29 for more information about sewing the patterns.

* When you want to revise edited patterns, see page 6-30.

Example

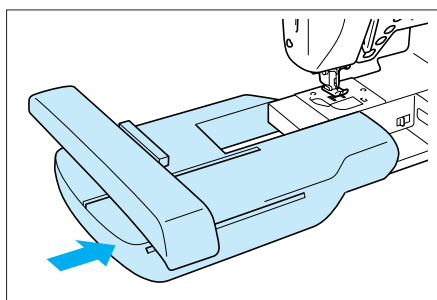

1. Attach the embroidery unit, and prepare the machine for embroidery (see page 5-3).

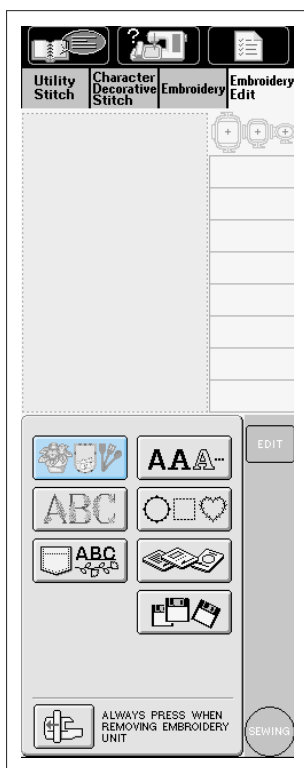



2. Press **Embroidery Edit** to call the screen at left.

3. Select a border.

① Press .

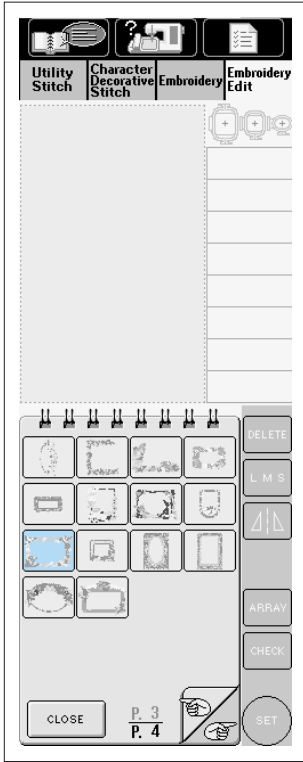



② Press  2 times, then press  to select the border.

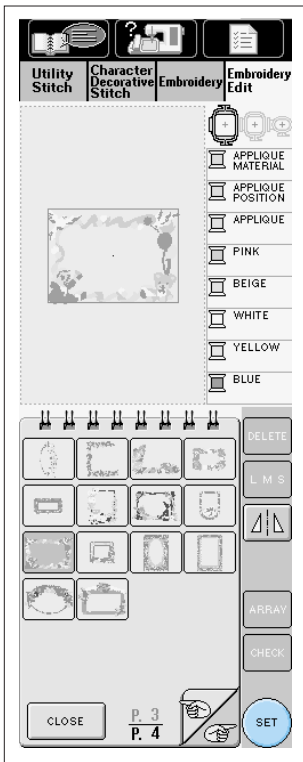

4. Press .

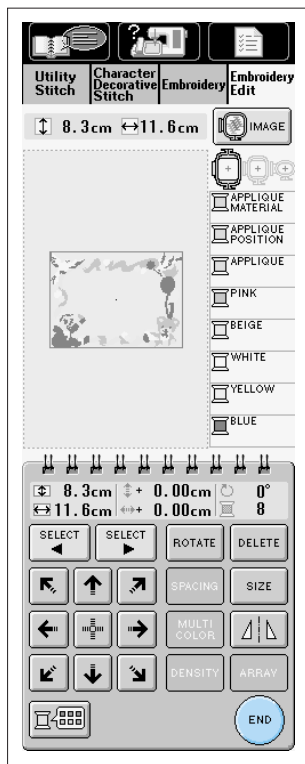

5. Press **END**.

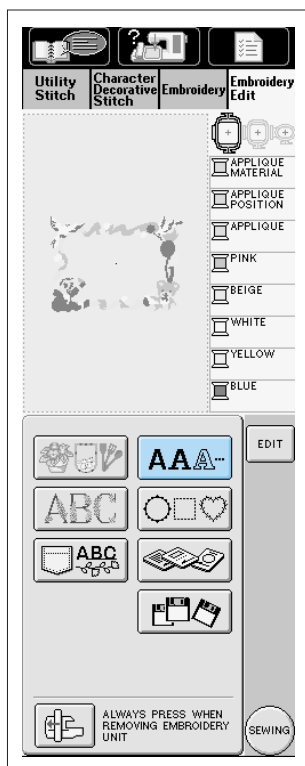

6. Select the characters "Happy."

① Press **AAA**.

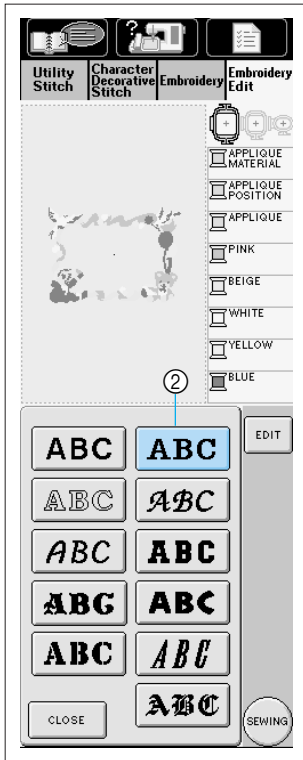

② Press the key of the font you wish to use (Example: **ABC**).



③ Enter "Happy."

The letters you enter will be displayed in the center of the embroidery frame.

- * If you want to change the size, select **H**, then use **LMS** to change the size.
- * If you want to change the appearance of the letter part of the pattern, press **ARRAY**.

7. After selecting the characters, press **SET**.

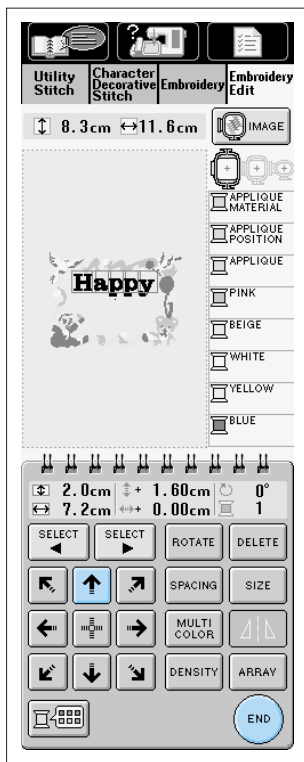

8. Use to move the letters.

9. Press .

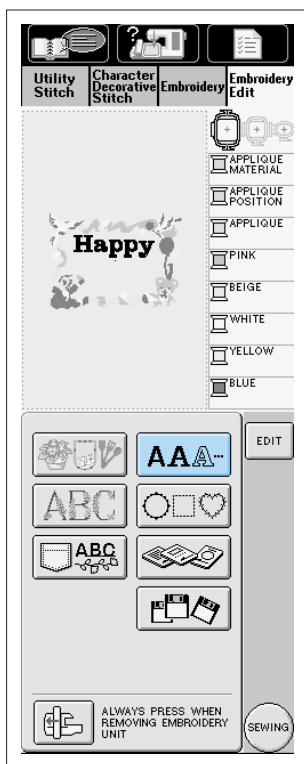

10. Press again.



11. Select the same font, then enter "Birthday". The letters will appear in the middle of the embroidery area display.

12. Press .

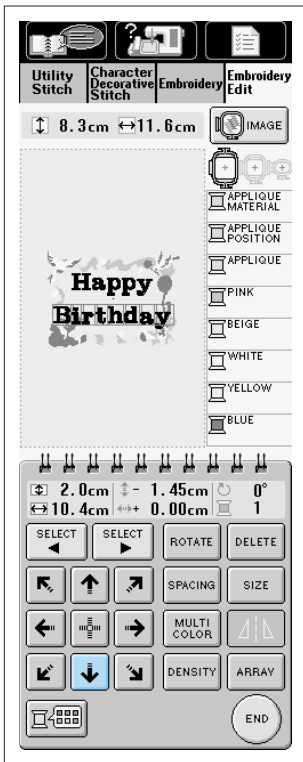

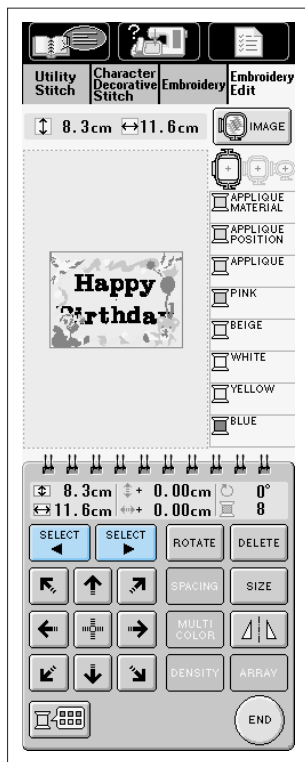

13. Use to move the letters.



14. If you want to alter the combined pattern, use **SELECT** **SELECT** to select the part of the pattern you want to change.

Example: Changing the size of the border ()

- ① Press **SELECT** **SELECT** to move the red outline over .
- ② Press **SIZE** and enlarge the border.
- ③ Press **CLOSE** to return to the Embroidery Edit screen.

* If the characters or the entire pattern can not be seen clearly, press **IMAGE** , then use  to check the pattern. Press **CLOSE** to return to the original screen.

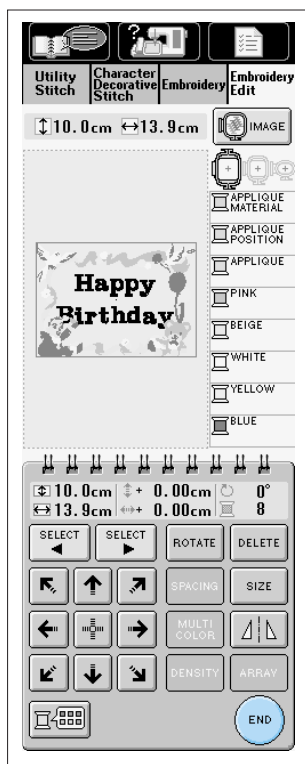

15. When all editing is finished, press **END** .



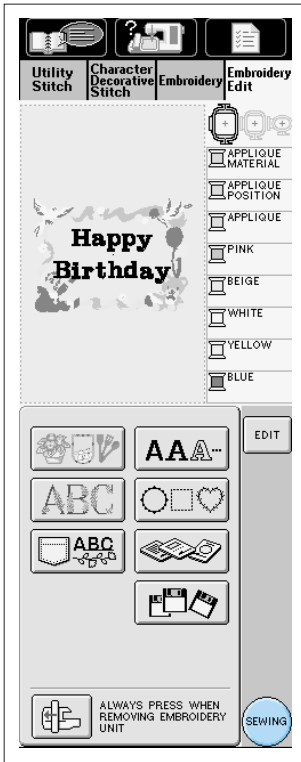

16. If you plan to sew the pattern at that time, press .

- * Press  to re-edit the pattern.
- * To combine the pattern with another pattern, select the new pattern type from this screen.

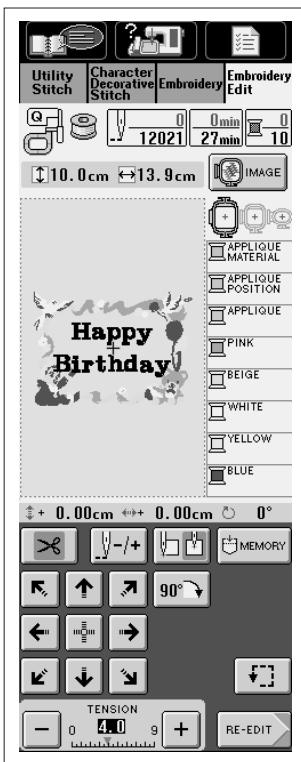

17. The sewing screen appears.

- * When you want to revise edited patterns, see page 6-30.

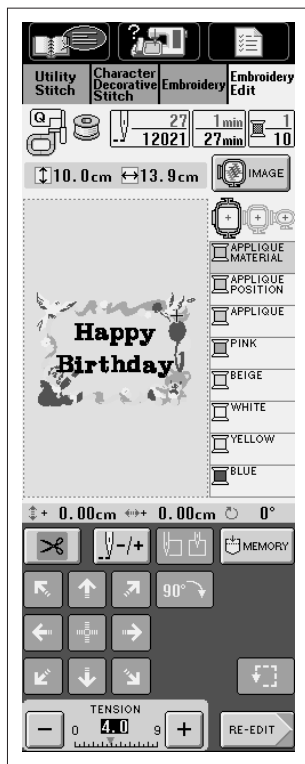

Combined patterns will be embroidered in the order they were entered. In this example, the embroidery order will be as follows:



, "Happy", "Birthday".

CAUTION

Follow the instructions from Chapter 5 for embroidering the pattern.

1. The machine will embroider  first. The embroidery will follow the color order on the right side of the display.

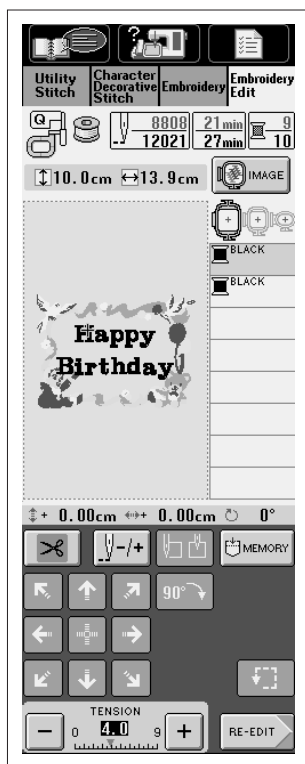

2. When the border is finished, the green "cross" cursor will change to the "Happy" part of the pattern. Sew this part of the pattern next.



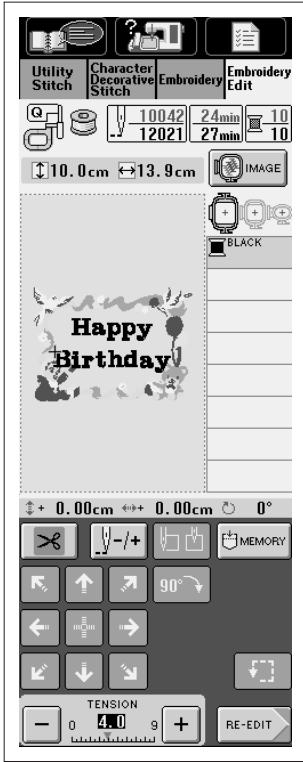

- When "Happy" is embroidered, the green "cross" cursor will change to the "Birthday" part of the pattern. Sew this part of the pattern next.

ADJUSTING EDITED PATTERNS

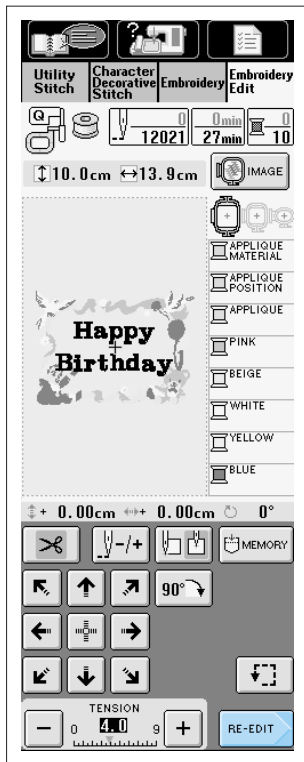

1. Press **RE-EDIT**.



2. Press **EDIT**.

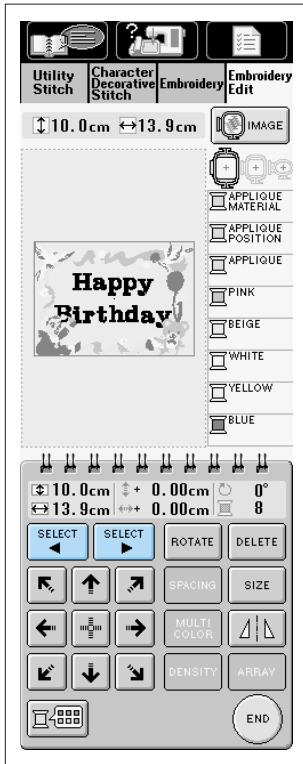

3. The machine will return to the embroidery edit screen.

4. Press **SELECT** **SELECT** to choose the section of the combined pattern to edit, and change the pattern.

MEMORY FUNCTIONS

Saving Edited Patterns

■ Saving a Pattern

You can save edited patterns for later use.

1. Press .

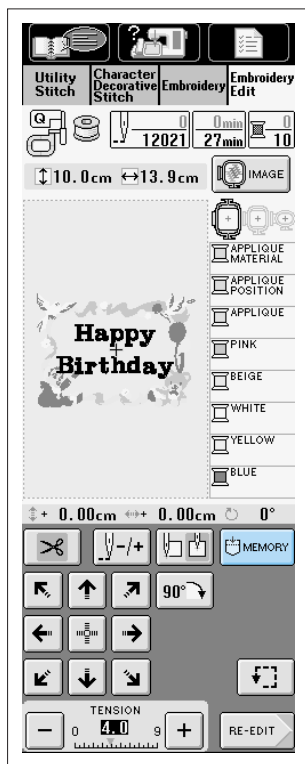

2. Choose where you want to save the pattern.

Press  to save the pattern in the machine memory. If you have the floppy disk drive on your machine, you press

 to save the pattern on a floppy disk.

Note

If your machine did not come furnished with a built-in floppy disk drive, you can receive an upgrade service for your machine, so that it can use floppy disk at your authorized dealer.

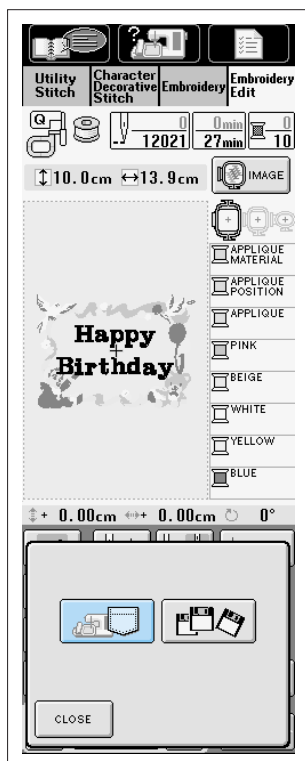

1 —



2 —



3 —



4 —



5 —



6 —



7 —



8 —



9 —



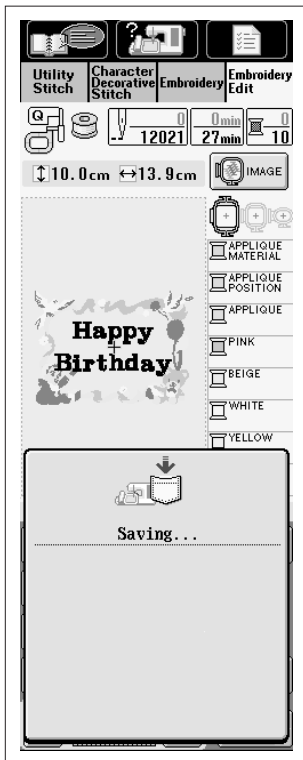

- The "Saving" screen displays. When the pattern is saved, the display returns to the original screen automatically.

CAUTION

Do not turn off the main power switch while the "Saving" screen is displayed. You may lose the pattern you are saving.

Note

It takes about 10 seconds to save a pattern.

See page 6-36 for information about retrieving saved patterns.

■ If You Can Not Save the Pattern

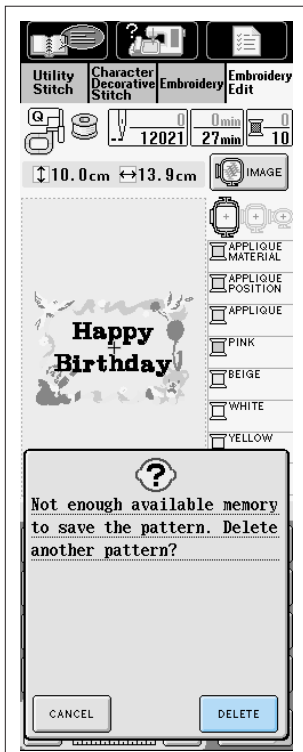

If the screen shown at left displays, the maximum number of patterns have been saved, or the pattern you want to save takes a lot of memory, the machine can not save it. If you delete a previously saved pattern, you can save the current pattern.

- * If you choose not to save the current pattern, press .

To delete a previously saved pattern

- Press .

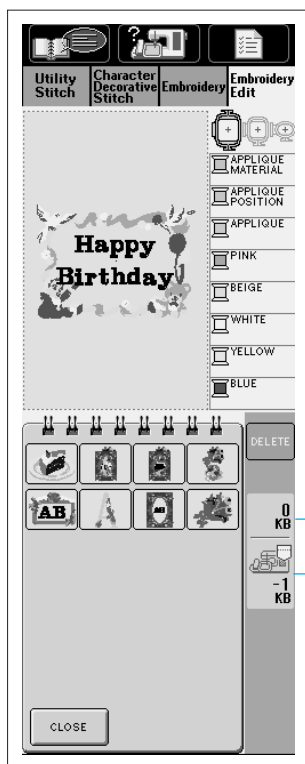

2. Previously saved patterns are displayed.
3. Select the pattern you want to delete.

- ① Shows the amount of memory the selected pattern uses.
- ② Shows how much memory you need to clear to save the current pattern.



4. Press .



5. Press **OK** to delete the pattern. .

* If you decide not to delete the pattern, press **CANCEL** .

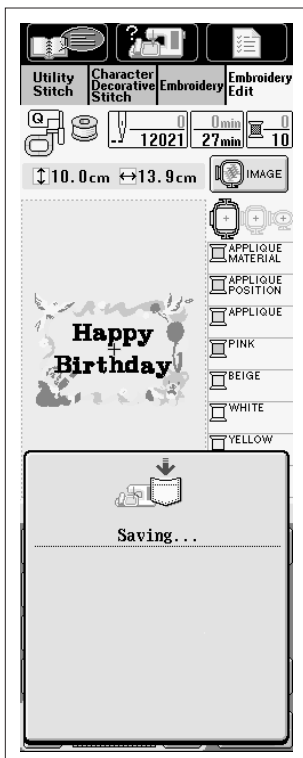

6. If there is enough memory available after deleting the pattern, the pattern you want to save will be saved automatically. If there is not enough memory available after deleting the pattern, repeat the steps above to delete another pattern from the machine's memory.

The display will automatically return to the original screen after saving the pattern.

CAUTION

Do not turn off the main power switch while the "Saving" screen is displayed. You may lose the pattern you are saving.

Note

It will take about 10 seconds to save the pattern.

See page 6-36 for information about retrieving previously saved patterns.



Retrieving Saved Patterns

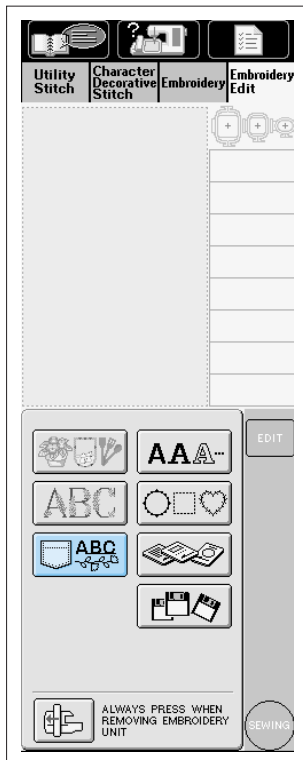

1. Press .

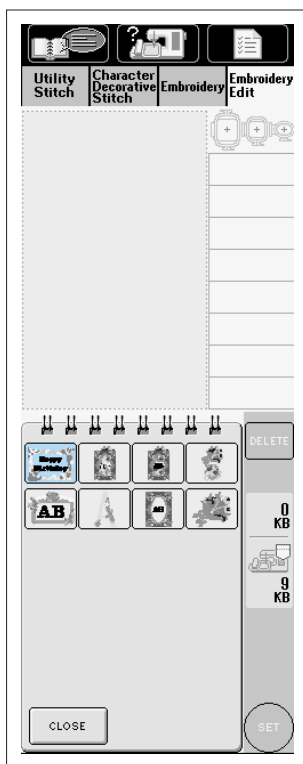

2. The machine displays the patterns saved in the memory. Select a pattern to retrieve.

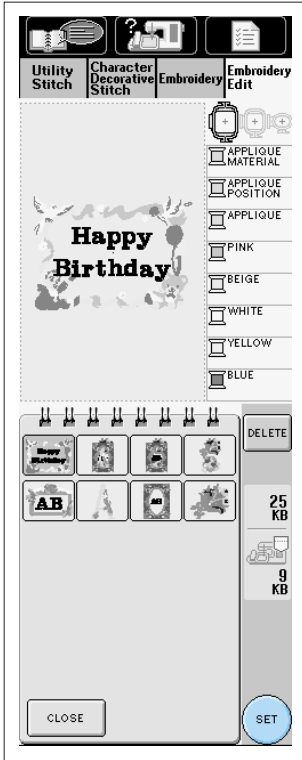

3. Select the pattern you want to retrieve, and press

* If you decide not to retrieve a pattern, press . You will return to the embroidery edit screen.

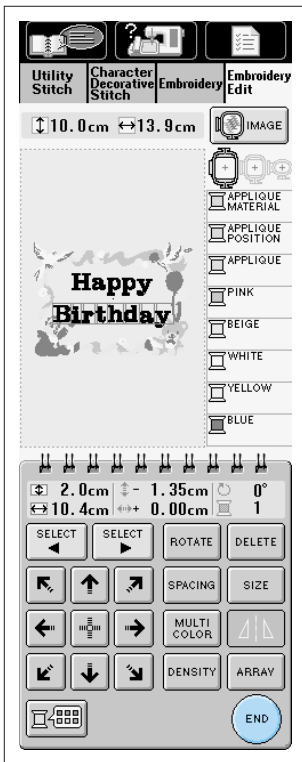

4. Press

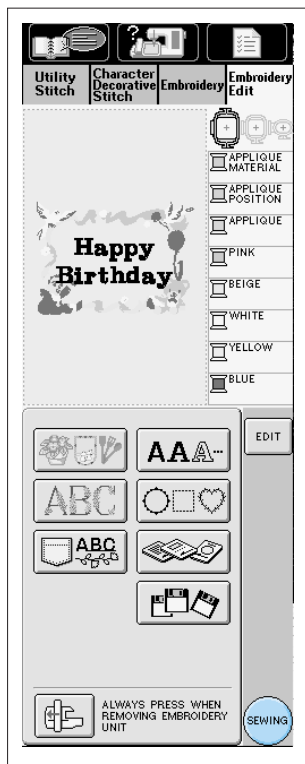

5. Press

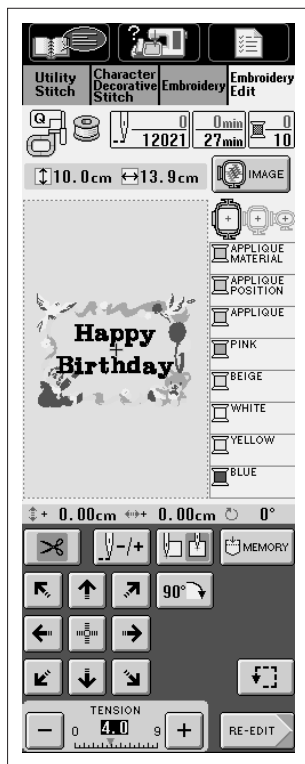

6. The machine retrieves the pattern and prepares to embroider it.

Chapter 7 MY CUSTOM STITCH

DESIGNING THE STITCH

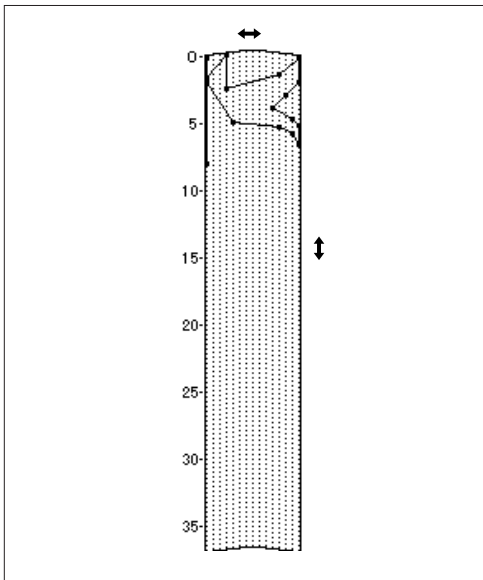
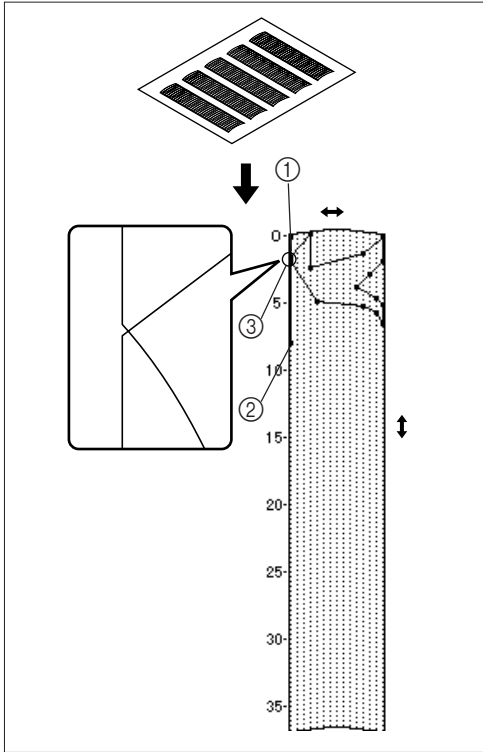

With the MY CUSTOM STITCH™ function, you can sew designs that you create yourself.

Note

- Stitches that you create with MY CUSTOM STITCH™ can be a maximum of 7 mm (9/32 inch) wide and 37 mm (1-1/3 inch) long.
- Stitches can be designed more easily with MY CUSTOM STITCH™ if you draw the stitch on the enclosed grid sheet first.

1. Draw the stitch design on the grid sheet (part code SA507, X81277-001).

- ① Start point
- ② End point
- ③ Intersection

Note

- Simplify the design so that it can be sewn as a continuous line. For a more attractive stitch, close the design by intersecting lines.
- If the design will be repeated and linked, the start point and end point of the design should be at the same height.

2. Mark the points in the design where the direction of the stitching changes.

3. Determine the x and y coordinates of each of the marked points. This will determine the design of the stitching that will be sewn.

	Stitch	1	2	3	4	5	6	7	8	9	10	11	12	13	14	15
	↕	00	12	18	22	23	21	17	14	12	09	06	03	01	03	06
	↔	00	00	03	06	10	13	14	13	11	13	14	13	10	06	03
	Stitch	16	17	18	19	20	21	22	23	24	25	26	27	28	29	30
	↕	12	41	43	40	41	38	35	32	30	32	35	41	45	47	44
	↔	00	00	04	07	11	13	14	13	10	06	03	00	00	04	07
	Stitch	31	32	33	34	35	36	37	38	39	40	41	42	43	44	45
	↕	45	47	50	54	56	55	51	45	70						
	↔	11	13	14	13	10	06	03	00	00						



	Stitch	1	2	3	4	5	6	7	8	9	10	11	12	13	14	15
	↕	00	30	32	32	32	33	35	35	37	35	32	30	30	29	26
	↔	00	00	01	07	10	12	11	08	12	14	14	11	05	03	08
	Stitch	16	17	18	19	20	21	22	23	24	25	26	27	28	29	30
	↕	24	18	13	12	13	10	12	08	12	07	12	06	10	05	10
	↔	10	13	14	14	12	11	10	09	08	06	06	03	02	00	02
	Stitch	31	32	33	34	35	36	37	38	39	40	41	42	43	44	45
	↕	16	19	23	22	17	22	23	19	42						
	↔	01	00	00	06	10	06	00	00	00						



	Stitch	1	2	3	4	5	6	7	8	9	10	11	12	13	14	15
	↕	00	03	05	08	12	17	20	24	27	29	31	32	30	27	24
	↔	00	05	08	11	13	14	14	13	12	11	09	06	03	01	00
	Stitch	16	17	18	19	20	21	22	23	24	25	26	27	28	29	30
	↕	21	18	16	15	15	16	18	21	25	28	33	37	41	43	44
	↔	00	01	03	05	08	10	12	13	14	14	13	11	08	05	00
	Stitch	31	32	33	34	35	36	37	38	39	40	41	42	43	44	45
	↕															
	↔															



	Stitch	1	2	3	4	5	6	7	8	9	10	11	12	13	14	15
	↕	00	05	04	05	08	07	08	11	11	11	16	11	07	04	00
	↔	07	07	03	07	07	00	07	07	03	07	07	03	00	03	07
	Stitch	16	17	18	19	20	21	22	23	24	25	26	27	28	29	30
	↕	04	07	11	16	21	20	21	24	23	24	27	27	27	32	27
	↔	11	14	11	07	07	11	07	07	14	07	07	11	07	07	11
	Stitch	31	32	33	34	35	36	37	38	39	40	41	42	43	44	45
	↕	23	20	16	20	23	27	32								
	↔	14	11	07	03	00	03	07								



ENTERING STITCH DATA

Creating Stitch Data

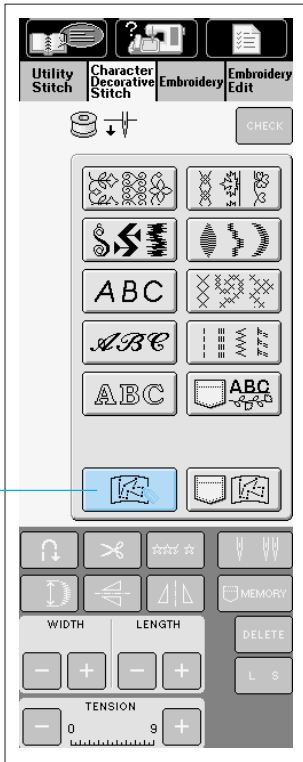





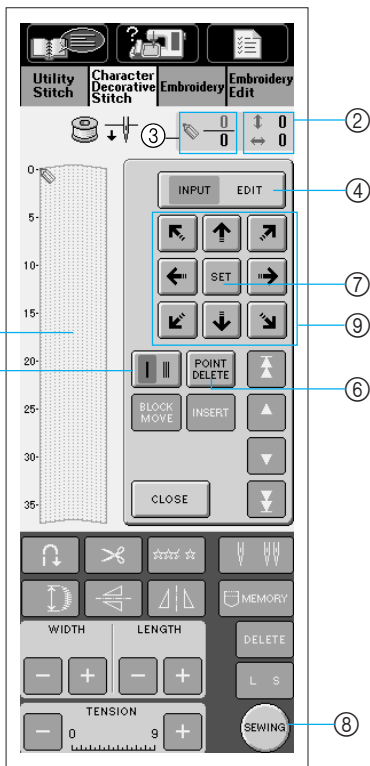

Note

Make sure that the embroidery unit is not attached.

1. Press  to display the screen at left.
2. Press .
 - ① MY CUSTOM STITCH™ key

①



- ① This area displays the stitch that is being created.
- ② The number beside  indicates the y coordinate of the tip of , and the number beside  indicates the x coordinate of the tip of .
- ③ This number indicates the present set point in relation to the entire number of set points in the design.
- ④ Press this key to display a screen that allows you to change a set point. (Refer to page 7-6 for more details).
- ⑤ Press this key to select whether one stitch or three stitches are sewn between two points.
- ⑥ Press this key to erase the last point that has been set.
- ⑦ Press this key to add the point indicated by .
- ⑧ Press this key to finish creating the stitch and display the screen that allows you to see the entered stitch. (Refer to page 7-4.)
- ⑨ Press these keys to move.

①

⑤

⑧

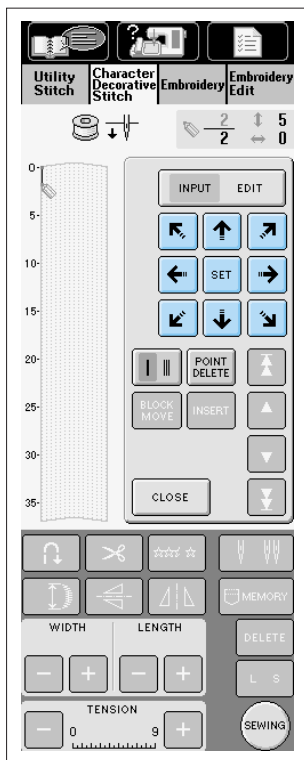

3. Select whether one stitch or three stitches will be sewn between the first two points. To sew one stitch, press so that it appears as ; to sew three stitches, touch the key so that it appears as .

4. Use the keys to move to the coordinates of the first point that was made on the grid sheet (from step 2 on page 7-1).

5. Press to add the point indicated by .

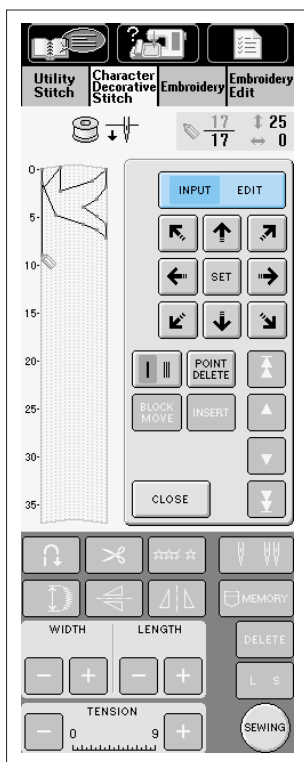



6. Repeat steps 3 through 5 for each point that you have drawn on the grid sheet until the stitch design is drawn on the screen as a continuous line.

Note —
If you make a mistake while setting points, press the key to erase the last point set.

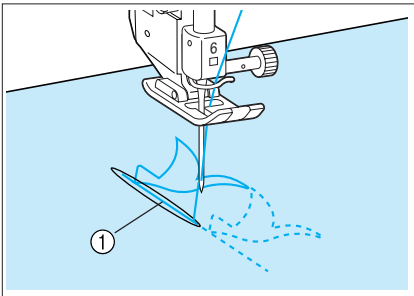
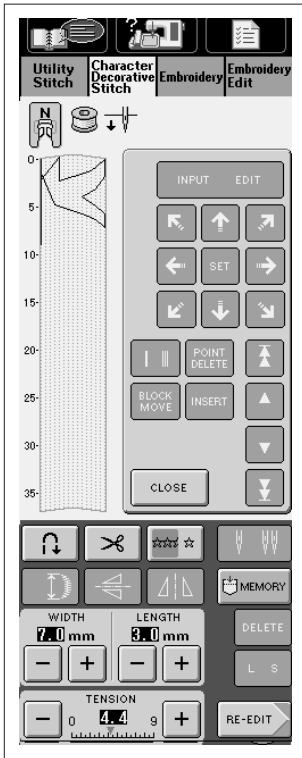
7. Once you have finished entering the stitch data, press the .



A screen that allows you to see the entered stitch design appears.

- * Press this key so that it appears as  to sew the stitch design repeatedly. Press this key so that it appears as  to sew the stitch design only one single time.
- * Press  to return to the screen that allows you make changes to the entered data.
- * If the stitch design will be repeated and linked, make sure that linking stitches are added so that the stitch designs will not overlap.

① Linking stitches

Note

If you have entered points that are too close together, the fabric may not feed properly. Edit the stitch data to leave a larger space between points.

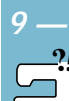

Editing Stitch Data

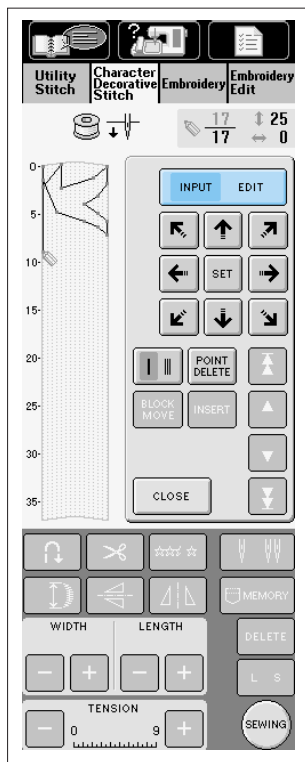

1. Press .

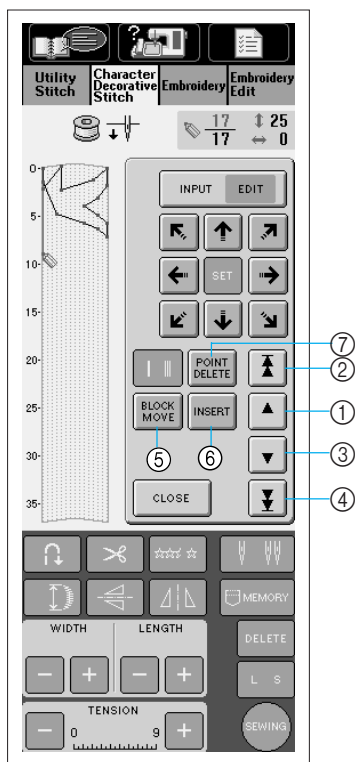

A screen that allows you to edit the entered stitch design appears.

- ① Press this key to move backward one point.
- ② Press this key to move start point.
- ③ Press this key to move forward one point.
- ④ Press this key to move end point.
- ⑤ Press this key to move part of or all of the design. (Refer to page 7-8 for more details.)
- ⑥ Press this key to insert a point. (Refer to page 7-9 for more details.)
- ⑦ Press this key to delete the selected point.

2. Make the desired changes to the stitch design.

■ Moving a Point

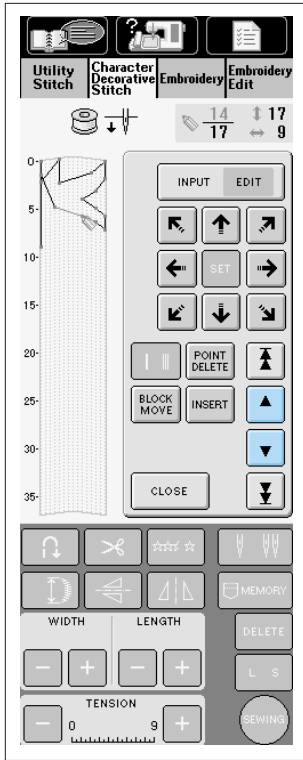

1. Press or to move to the point that you wish to move.

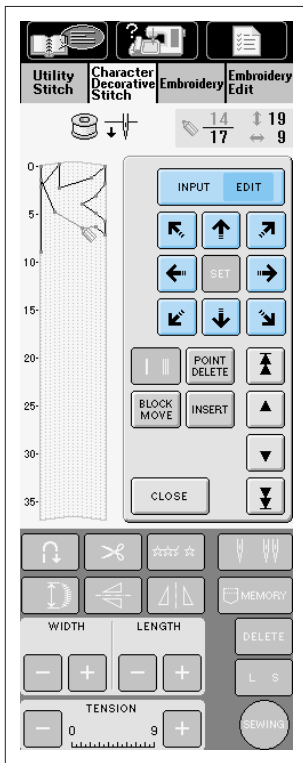

2. Use to move the point to the desired position.

3. When finished revising the pattern, press so it appears as .

4. Press to go to the sewing screen. (See page 4-9 for instructions on sewing the stitch).



■ Moving Part or All of the Design

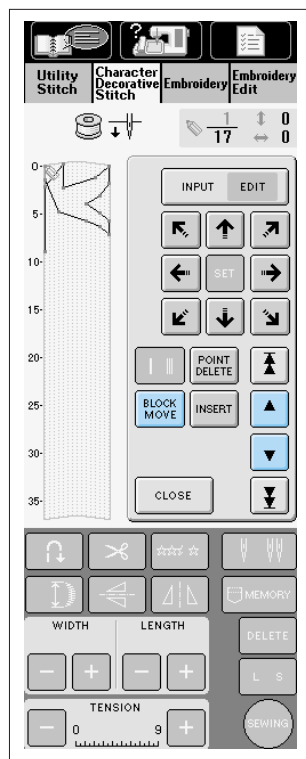

1. Press or to move to the first point of the section that you wish to move.
2. Press . The selected point and all points that come after it are surrounded by a box. (This indicates the area that is to be moved.)

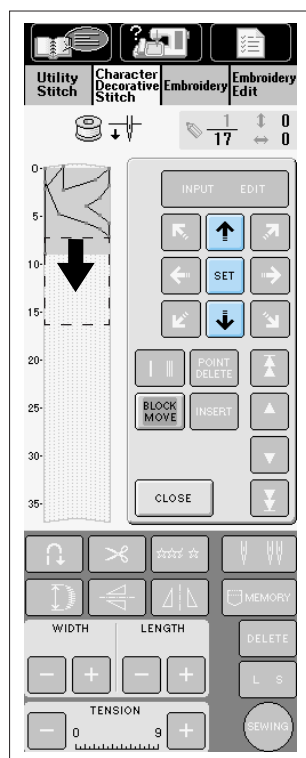

3. Press or to move the selected section to the desired location.
4. Press . The selected section has been moved.

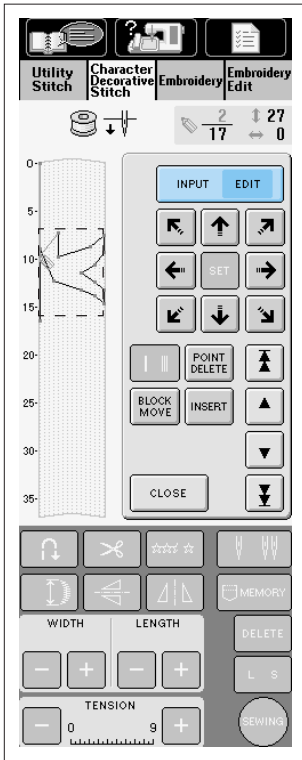

- When finished revising the pattern, press so it appears as .
- Press to go to the sewing screen (see page 4-9 for instructions on sewing the stitch).

■ Inserting New Points

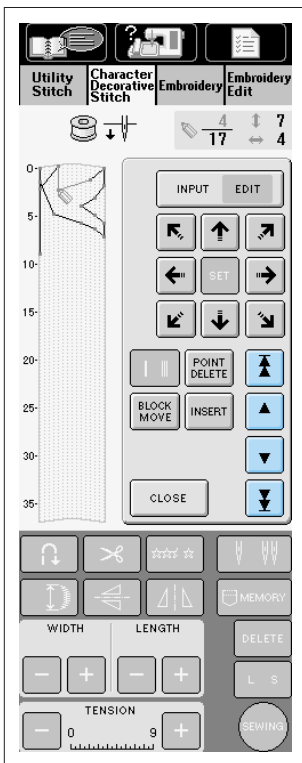

- Press to move to point at the beginning of the line that you wish to add a new point to.

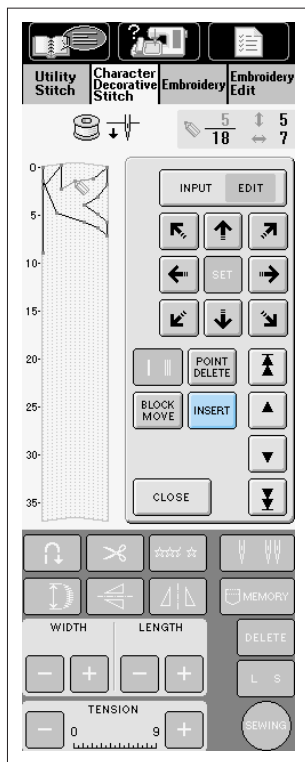
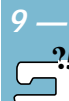

2. Press **INSERT**. A new point is inserted and the moves to it.

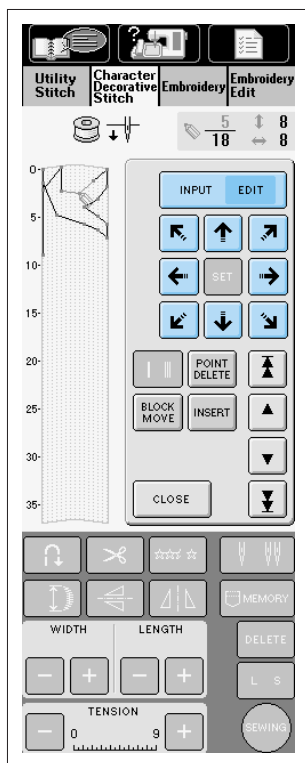

3. Use any of to move the point to the desired position.

4. When finished revising the pattern, press **INPUT EDIT** so it appears as **INPUT EDIT**.

5. Press **SEWING** to go to the sewing screen. (See page 4-9 for instructions on sewing the stitch).

MEMORY FUNCTIONS

Storing the custom design

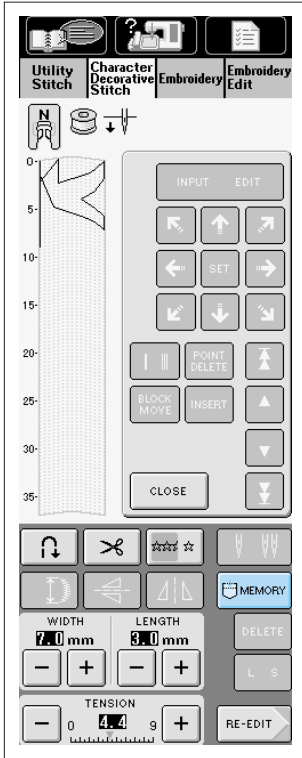

Up to fifteen custom stitch patterns can be stored. Touch  (it will take approximately 10 seconds for the pattern to be saved). Once the pattern has been saved, the display will return to the previous screen.

Refer to the next page for details on how to retrieve a pattern which has been stored.

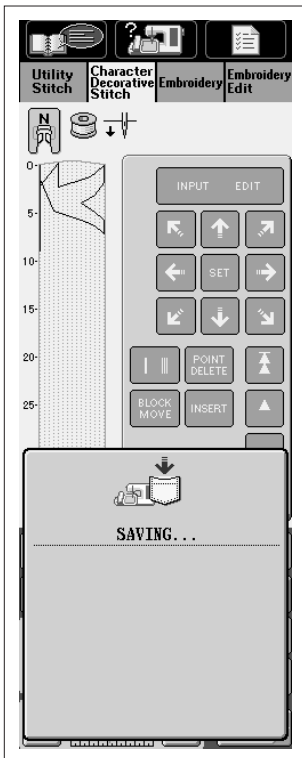

CAUTION

Do not turn off the power while the "Saving" screen is displayed. Otherwise, you may lose the pattern you are saving.



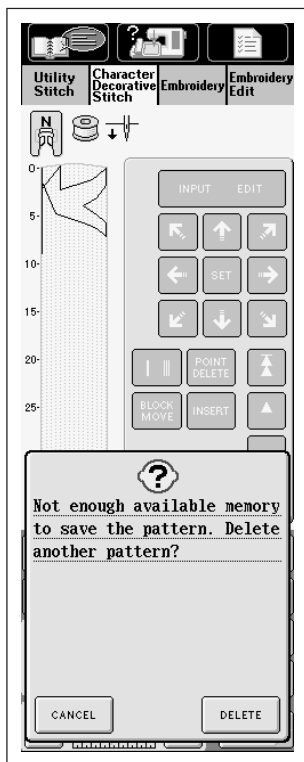

See page 4-27 for details on what to do if the pattern cannot be stored because the memory is already full.



Retrieving a Stitch Design That Has Been Saved

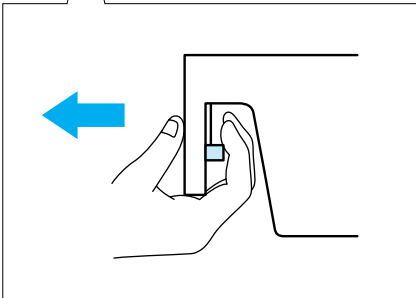
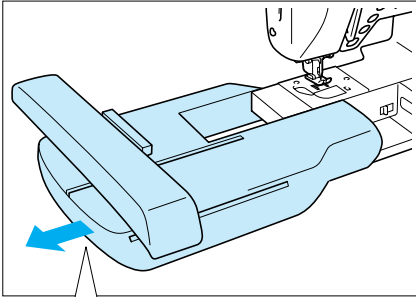



Preparation

If the embroidery unit is attached, remove it.

- ① Release button

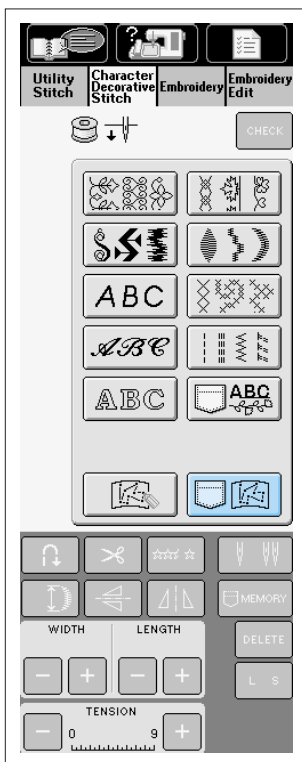
* Turn off the power supply before removing the embroidery unit.



1. Press the .
2. Press .

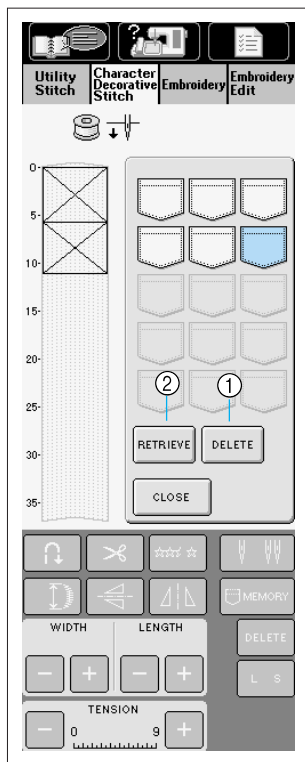

The indicates a pocket which has a pattern saved in it. If you press a , the pattern which is saved in that pocket will be displayed.

3. Press a to select a saved pattern and have it displayed.

- ① Press this key to delete a saved pattern.
- ② Press this key to retrieve a saved pattern.

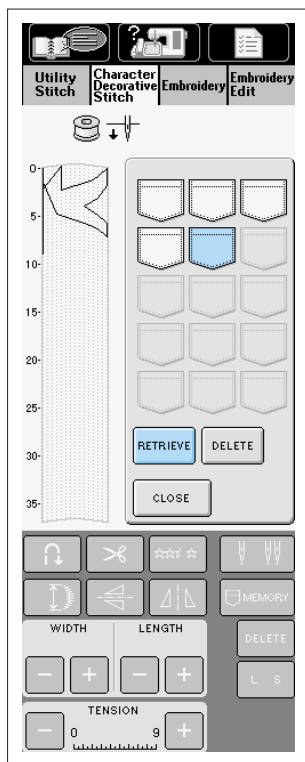

4. Press to make the selected stitch available for sewing.

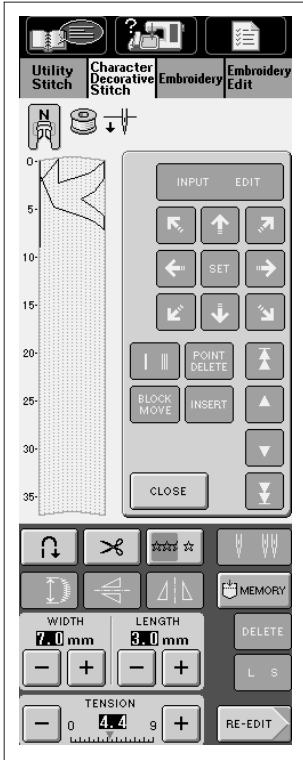

5. The sewing screen for that stitch will then be displayed.

1 —



2 —



3 —



4 —



5 —



6 —



7 —



8 —



9 —



Chapter 8 Care and Maintenance

CHANGING THE LIGHT BULB

▲ CAUTION

- Turn off the main power switch and unplug the machine before changing the light bulb. If the machine is on and the “Start/Stop” button is pressed accidentally, injuries may result.
- To avoid burns, give the light bulb time to cool before changing it.

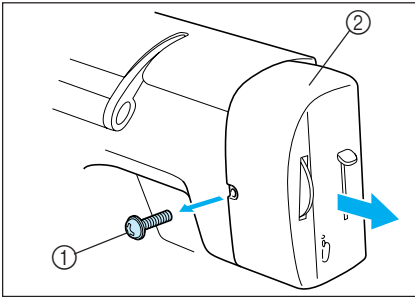

1. Turn off the main power switch.
2. Use a screwdriver to loosen the screw on the back of machine light cover. Then remove the light cover.
 - ① Screw
 - ② Light cover

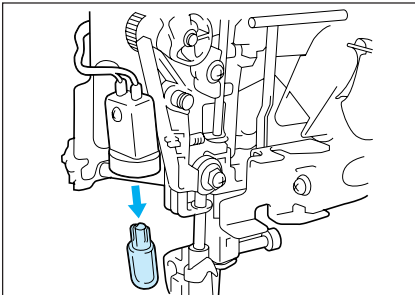

3. Remove the light bulb as shown, and align the projection on the light bulb with the notch in the socket. Replace it with a new light bulb.

CAUTION

Use only light bulbs intended for use with this machine (12V/ 5W: part code XA2037001). You can get the proper light bulb at your authorized dealer.

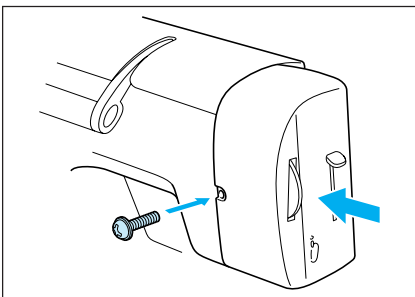

4. Place light cover and tighten the screw on the back of the machine.



CLEANING THE MACHINE

▲ CAUTION

Be sure to unplug the machine before cleaning it. Otherwise, electric shock or injury may result.

■ Cleaning the LCD Screen

If the screen is dirty, gently wipe it with a soft, dry cloth. Do not use organic solvents or detergents.

■ Cleaning the Machine Casing

If the surface of the machine is dirty, lightly soak a cloth in a neutral detergent, squeeze it out firmly and then wipe the surface. Then wipe again with a dry cloth.

■ Cleaning the Race and Shuttle

If dust or bits of dirt collect in the race or shuttle, the machine will not run well, and the bobbin thread detection function may not operate. Keep the machine clean for best results.

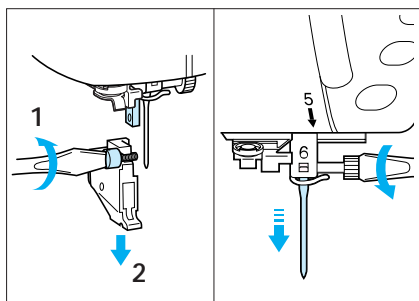

1. Turn off the power. Remove the presser foot holder and the needle.

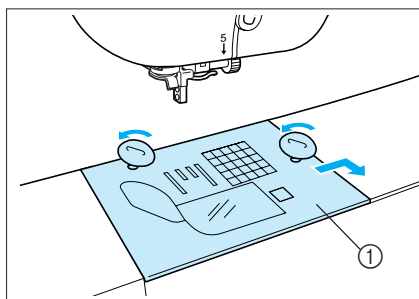

2. Loosen the screws with the disc-shaped screwdriver and remove the needle plate.
 - ① Needle plate

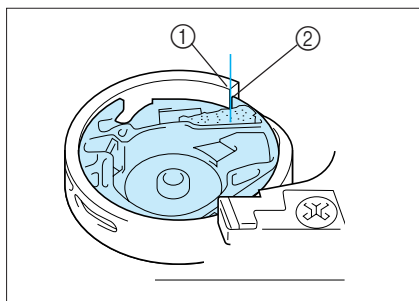

3. Turn the balance wheel, and align the notch of shuttle a little to the left of the shelf of race, as shown.

CAUTION

Be sure to turn the balance wheel towards the front of the machine. Turning the balance wheel in the other direction may damage the machine.

- ① Notch of shuttle
- ② Shelf of race



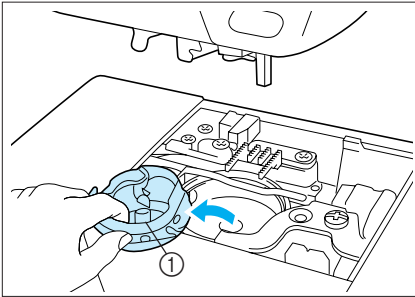

4. Remove the race.

* While pushing the race towards the back of the machine, lift the edge nearest you and remove the race.

① Race

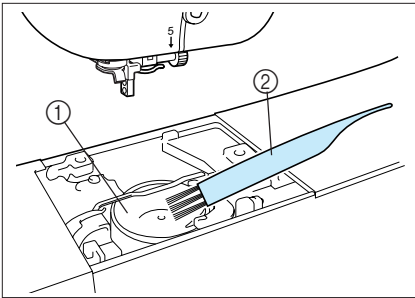

5. Remove accumulated lint and thread from the inner shuttle and race with a brush or vacuum cleaner.

* Do not oil the shuttle or the race.

① Shuttle

② Brush

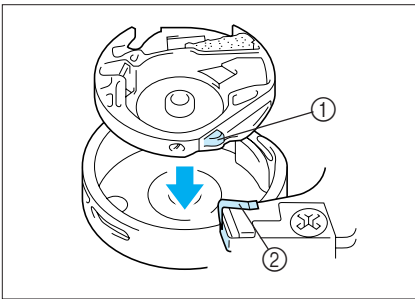

6. Check that the notch on the shuttle is in the same position as when you removed the race. Position the race so that the shelf and spring are aligned, and insert the race.

▲ CAUTION

- Do not use a damaged race or shuttle. Otherwise, the thread may tangle and cause a poor finish, or the needle may break. You can get the proper parts from your authorized dealer.
- Be sure to insert the race in the correct position. Otherwise, the needle may break.

① Shelf

② Spring

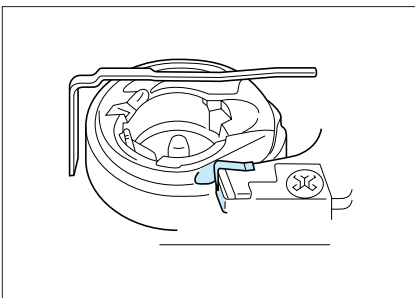

7. Reattach the needle plate.



CLEANING THE FLOPPY DISK DRIVE HEADS

If the heads of the floppy disk drive become dirty, the data on the disks may not be read normally. We suggest that you use a cleaning disk for 3.5 inch floppy disk drives regularly.

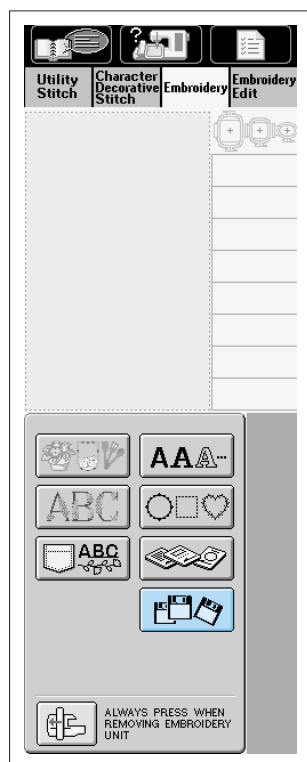

1. Insert the cleaning disk when the screen at left is displayed.

* If a different screen is displayed, press **Embroidery** to display the screen at left.

* Insert the cleaning disk into the floppy disk drive, located on the right side of the machine. Be sure to follow the directions given on the cleaning disk package.

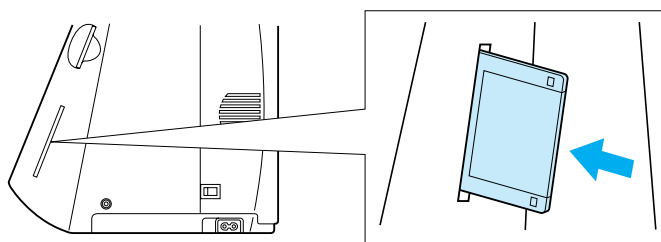

2. Press .

Head cleaning will begin.

3. When cleaning is finished, the screen at left will display.

4. Press **CLOSE**. When the screen display returns to the display in step one, remove the cleaning disk.

Note

If the floppy disk still can not be read correctly after finishing the steps above, repeat the cleaning operation several times.

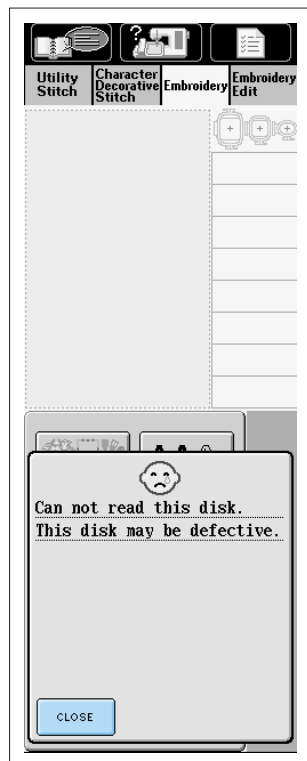

Chapter 9 Troubleshooting

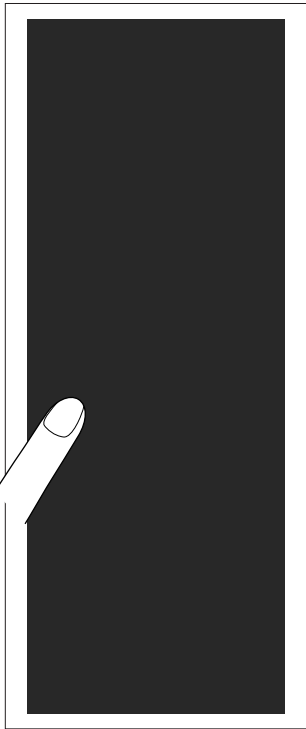

ADJUSTING THE SCREEN

If the screen is difficult to see when you turn on the power, follow the steps below.

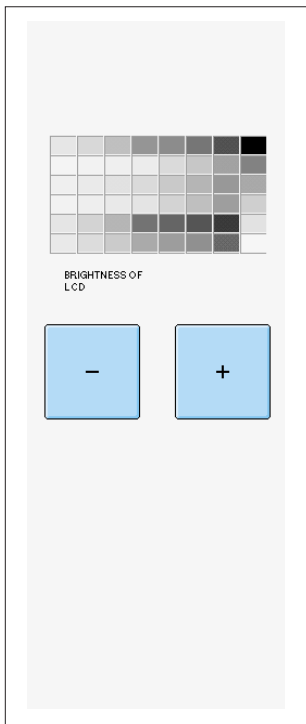

1. Press your finger anywhere on the screen. Holding your finger on the screen, turn the main power switch off and back on.
 - * The "Start/Stop" button does not light up at this time.



2. Go to the Brightness of LCD display. Use the  ,  keys to adjust the screen until you can see it easily.
3. When the adjustment is finished, turn the main power switch off and back on.



ADJUSTING THE TOUCH PANEL

If the screen does not respond correctly when you touch a key (the machine does not perform the operation or performs a different operation), follow the steps below to make the proper adjustments.

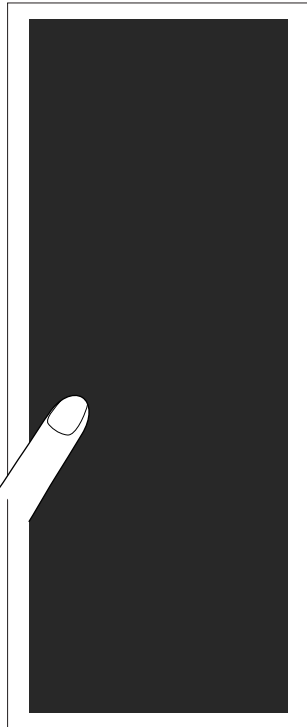

1. Press your finger anywhere on the screen. Holding your finger on the screen, turn the main power switch off and back on.
 - * The "Start/Stop" button does not light up at this time.

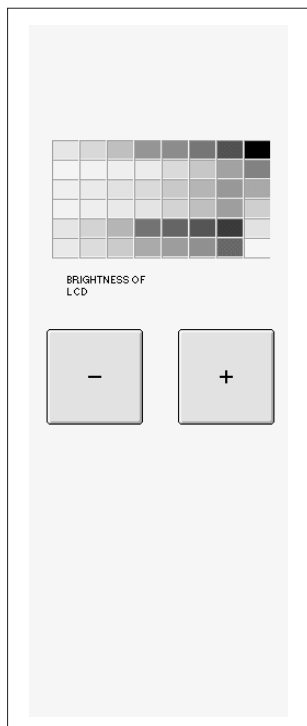

2. The machine displays the screen shown at left.



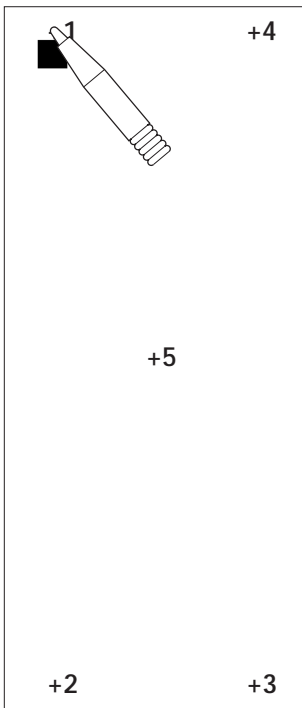
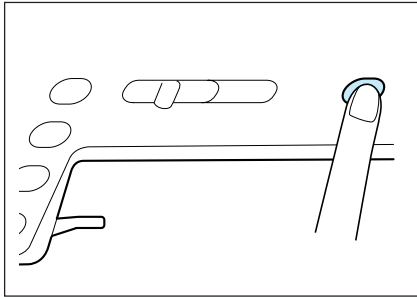

3. Press the "Bobbin Winding" button.

4. The machine displays the screen shown at left.

5. Using the included touch pen, lightly touch the center of the +, in order from 1 to 5.

CAUTION

Only use the included touch pen to touch the screen. Do not use a mechanical pencil, pin, or other sharp object. Do not press strongly on the screen. Otherwise, damage may result.

6. Press the numbers in order 1 - 5. If the buzzer sounds one time after you press number 5, the operation is finished. If the buzzer sounds twice, there was an error. In this case, repeat the steps above.

7. The screen adjustment is finished. Turn off the main power switch, then turn it back on.

CAUTION

If you finish the screen adjustment and the screen still does not respond, or if you can not do the adjustment, contact your authorized dealer.



USING THE "TROUBLESHOOTING" FUNCTION

Use the troubleshooting key for advice about minor sewing problems during sewing.

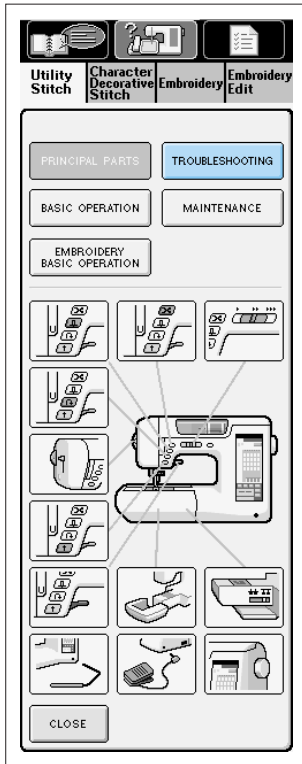

1. Press  to call the screen at left.

2. Press .

* Press  at any time to return to the original screen.

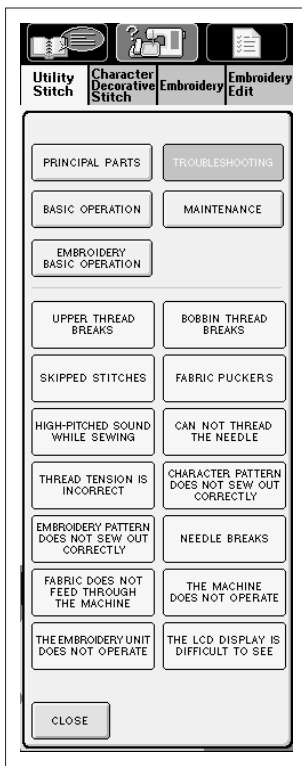

3. Find the category for the problem and press the appropriate key.

MAKING MINOR MACHINE ADJUSTMENTS

If you have a minor problem with your sewing machine, check the following solutions. If the solutions suggested do not correct the problem, contact your authorized dealer.

Problem	Cause	Solution	Page
Upper thread breaks	① Machine is not threaded correctly (used the wrong spool cap, spool cap is loose, the thread did not catch the needle bar threader, etc.)	Rethread the machine correctly.	1-32
	② Thread is knotted or tangled.	Re-thread upper and lower thread.	1-31, 1-32
	③ Thread is too thick for the needle.	Check needle and thread combinations.	1-45
	④ Upper thread tension is too strong.	Adjust the thread tension.	2-13, 5-40
	⑤ Thread is twisted.	Use scissors, etc., to cut the twisted thread and remove it from the race, etc.	7-2
	⑥ Needle is turned, bent or the point is dull.	Replace the needle.	1-43
	⑦ Needle is installed incorrectly.	Reinstall the needle correctly.	1-43
	⑧ There are scratches near the hole of the needle plate.	Replace the needle plate, or consult your authorized dealer.	8-2
	⑨ There are scratches near the hole in the presser foot.	Replace the presser foot, or consult your authorized dealer.	1-39
	⑩ There are scratches on the race.	Replace the race, or consult your authorized dealer.	8-2
Bobbin thread breaks	① Bobbin is set incorrectly.	Reset the bobbin thread correctly.	1-31
	② There are scratches on the bobbin or it doesn't rotate properly.	Replace the bobbin.	1-31
	③ Thread is twisted.	Use scissors, etc. to cut the twisted thread and remove it from the race, etc.	7-2
Skipped stitches	① Machine is threaded incorrectly.	Check the steps for threading the machine and rethread it correctly.	1-32
	② Using improper needle or thread for the selected fabric.	Check the "Fabric/Thread/Needle Combination" chart.	1-45
	③ Needle is turned, bent or the point is dull.	Replace the needle.	1-43
	④ Needle is installed incorrectly.	Reinstall the needle correctly.	1-43
	⑤ Needle is defective.	Replace the needle.	1-43
	⑥ Dust or lint is collected under the needle plate.	Remove the dust or lint with the brush.	8-2



Problem	Cause	Solution	Page
Fabric puckers	① There is a mistake in the upper or bobbin threading.	Check the steps for threading the machine and rethread it correctly.	1-32
	② Spool cap is set incorrectly.	Check the method for attaching the spool cap, then reattach the spool cap.	1-33
	③ Using improper needle or thread for the selected fabric.	Check the "Fabric/Thread/Needle Combination" chart.	1-45
	④ Needle is turned, bent or the point is dull.	Replace the needle.	1-43
	⑤ Stitches are too long when sewing thin fabrics.	Shorten the stitch length.	2-9
	⑥ Thread tension is set incorrectly.	Adjust the thread tension.	2-13, 5-40
	⑦ Wrong presser foot.	Use correct presser foot.	3-1
High-pitched sound while sewing	① Dust or lint is caught in the feed dogs.	Remove the dust or lint.	8-2
	② Pieces of thread are caught in the race.	Clean the race.	8-2
	③ Upper threading is incorrect.	Check the steps for threading the machine and rethread the machine.	1-32
	④ There are scratches on the race.	Replace the race, or consult your authorized dealer.	8-2
Can not thread the needle	① Needle is not in the correct position.	Press the "Needle Position" button to raise the needle.	1-3
	② Threading hook does not pass through the eye of the needle.	Press the "Needle Position" button to raise the needle.	1-3
	③ Needle is installed incorrectly.	Reinstall the needle correctly.	1-43
Thread tension is incorrect	① Upper threading is incorrect.	Check the steps for threading the machine and rethread the machine.	1-32
	② Bobbin is set incorrectly.	Reset the bobbin.	1-31
	③ Using improper needle or thread for the selected fabric.	Check the "Fabric/Thread/Needle Combination" chart.	1-45
	④ Presser foot holder is not attached correctly.	Reattach the presser foot holder correctly.	1-42
	⑤ Thread tension is set incorrectly.	Adjust the thread tension.	2-13, 5-40
Character pattern does not turn out	① Wrong presser foot was used.	Attach the correct presser foot.	3-1
	② Pattern adjustment settings were set incorrectly.	Revise the pattern adjustment settings.	4-11
	③ Did not use a stabilizer material on thin fabrics or stretch fabrics.	Attach a stabilizer material.	4-8
	④ Thread tension is set incorrectly.	Adjust the thread tension.	2-13

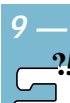

Problem	Cause	Solution	Page
Embroidery pattern does not sew out correctly	① Thread is twisted.	Use scissors, etc., to cut the twisted thread and remove it from the race, etc.	7-2
	② Fabric was not inserted into the frame correctly (fabric was loose, etc.).	If the fabric is not stretched tight in the frame, the pattern may turn out poorly or there may be shrinkage of the pattern. Set the fabric into the frame correctly.	5-21
	③ Stabilizing material was not attached.	Always use stabilizing material, especially with stretch fabrics, lightweight fabrics, fabrics with a coarse weave, or fabrics that often cause pattern shrinkage. See your authorized dealer for the proper stabilizer.	5-20
	④ There was an object placed near the machine, and the carriage or embroidery frame hit the object during sewing.	If the frame bumps something during sewing, the pattern will turn out poorly. Do not place anything in the area where the frame may bump it during sewing.	5-29
	⑤ Fabric outside the frame edges interferes with the sewing arm, so the embroidery unit can not move.	Reinsert the fabric in the embroidery frame so that the excess fabric is away from the sewing arm, and rotate the pattern 180 degrees.	5-46
	⑥ Fabric is too heavy, so the embroidery unit can not move freely.	Place a large thick book or similar object under the arm head to lightly lift the heavy side and keep it level.	—
	⑦ Fabric is hanging off the table.	If the fabric is hanging off the table during embroidery, the embroidery unit will not move freely. Place the fabric so that it does not hang off the table (or, hold fabric to keep from dragging).	5-29
	⑧ Fabric is snagged or caught on something.	Stop the machine and place the fabric so that it does not get caught or snagged.	—
	⑨ Embroidery frame was removed during sewing (for example, to reset the bobbin). The presser foot was bumped or moved while removing or attaching the embroidery frame, or the embroidery unit was moved.	If the presser foot is bumped or the embroidery unit is moved during sewing, the pattern will not turn out. Be careful when removing or reattaching the embroidery frame during sewing.	5-35

1 —



2 —



3 —



4 —



5 —



6 —



7 —



8 —



9 —



Problem	Cause	Solution	Page
Needle breaks	① Needle is installed incorrectly.	Reinstall the needle correctly.	1-43
	② Needle clamp screw is not tightened.	Tighten the needle clamp screw.	1-44
	③ Needle is turned or bent.	Replace the needle.	1-43
	④ Using improper needle or thread for the selected fabric.	Check the "Fabric/Thread/Needle Combination" chart.	1-45
	⑤ Wrong presser foot was used.	Use the recommended presser foot.	3-1
	⑥ Upper thread tension is too strong.	Adjust the thread tension setting.	2-13, 5-40
	⑦ Fabric is pulled during sewing.	Do not pull the fabric during sewing.	—
	⑧ Spool cap is set incorrectly.	Check the method for attaching the spool cap, then reattach the spool cap.	1-33
	⑨ There are scratches around the holes in the needle plate.	Replace the needle plate, or consult your authorized dealer.	8-2
	⑩ There are scratches around the hole(s) in the presser foot.	Replace the presser foot, or consult your authorized dealer.	1-39
	⑪ There are scratches on the race.	Replace the race, or consult your authorized dealer .	8-2
	⑫ Needle is defective.	Replace the needle.	1-43
Fabric does not feed through the machine	① Feed dogs are set in the down position.	Use the feed dog position lever to raise the feed dogs.	1-6
	② Stitches are too close together.	Lengthen the stitch length setting.	2-9
	③ Wrong presser foot was used.	Use the correct presser foot.	3-1
	④ Needle is turned, bent or the point is dull.	Replace the needle.	1-43
	⑤ Thread is entangled.	Cut the entangled thread and remove it from the race.	7-2

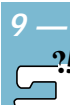

Problem	Cause	Solution	Page
Machine does not operate	① There is no pattern selected.	Select a pattern.	3-9, 4-1 5-8, 6-2
	② "Start/Stop" button was not pushed.	Push the "Start/Stop" button.	1-3
	③ Main power switch is not turned on.	Turn on the main power switch.	1-12
	④ Presser foot is not lowered.	Lower the presser foot.	1-4
	⑤ "Start/Stop" button was pushed with the foot controller attached.	Remove the foot controller, or use the foot controller to operate the machine.	1-7
	⑥ Using the foot controller for embroidery.	Remove the foot controller and use the "Start/Stop" button to operate the machine.	1-7
	⑦ Speed control lever is set to control the zigzag stitch width.	Use the foot controller instead of the "Start/Stop" button to operate the machine.	1-7
Embroidery unit does not operate	① There is no pattern selected.	Select a pattern.	5-8, 6-2
	② Main power switch is not turned on.	Turn on the main power switch.	1-12
	③ Embroidery unit is not attached correctly.	Reattach the embroidery unit correctly.	5-5
	④ Embroidery frame was attached before the unit was initialized.	Perform the initialization process correctly.	5-5
LCD display is difficult to see	① LCD contrast is not properly adjusted.	Adjust the LCD contrast.	1-16, 8-1

CAUTION

- This machine is equipped with a thread detection device. If the "Start/Stop" button is pushed before the upper threading is done, the machine will not operate properly. Also, depending on the pattern selected, the machine may feed the fabric even if the needle is raised. This is due to the needle bar release mechanism. At these times, the machine will make a sound different from that made during normal sewing. This is not the sign of a malfunction.
- If the power is disconnected during sewing:
 - Turn off the main power switch and unplug the machine.
 - If you restart the machine, follow the instructions for operating the machine correctly.



ERROR MESSAGES

If the machine is not properly set and the "Start/Stop" button or the "Reverse/Reinforcement Stitch" button is pressed, or if the operation procedure is incorrect, the machine does not start. An alarm sounds and an error message is displayed on the LCD. If an error message displays, follow the instructions in the message.

Below is an explanation of 49 error messages. Refer to these when necessary (if you press  or do the operation correctly while the error message is displayed, the message disappears).

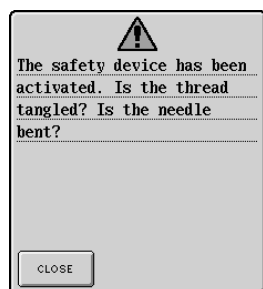

1. This message is displayed when the motor locks due to tangled thread or for other reasons relate to thread delivery.

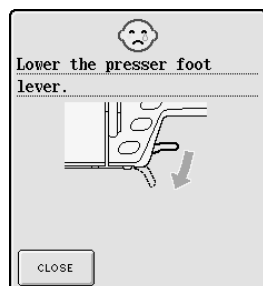

2. This message is displayed when the presser foot is raised and the "Start/Stop" button, "Reverse/Reinforcement Stitch" button, or "Thread Cutter" button pushed.

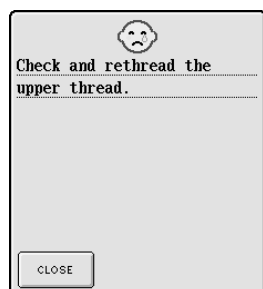

3. This message is displayed when the upper thread is broken or not threaded correctly, and the "Start/Stop" button or the "Reverse/Reinforcement Stitch" button is pressed.

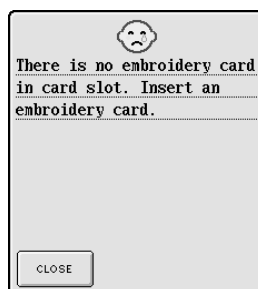

4. This message is displayed when the  is touched without an embroidery card inserted.

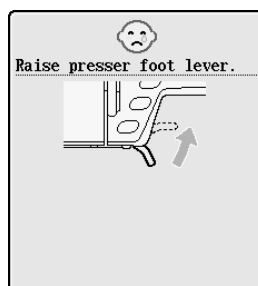

5. This message is displayed when the embroidery unit initialization is started with the presser foot lever down.

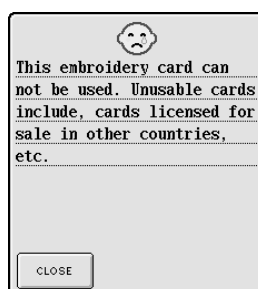

6. This message is displayed if the  is touched when an unusable embroidery card is inserted.

⚠ CAUTION

Be sure to rethread the machine. If you press the "Start/Stop" button without rethreading the machine, the thread tension may be wrong or the needle may break and cause injury.

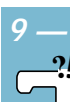

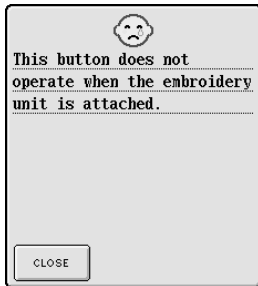
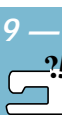

7. This message is displayed when the embroidery unit is attached, and the "Reverse/Reinforcement Stitch" button is pressed.

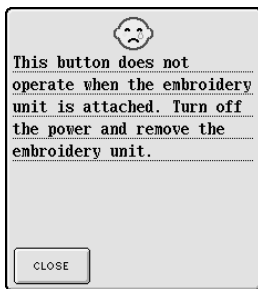

8. This message is displayed when the embroidery unit is attached, and the **Utility Stitch** or **Character Decorative Stitch** is pressed.

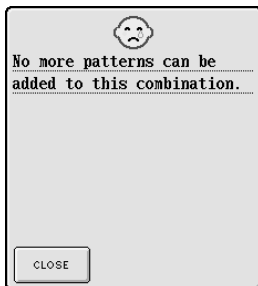

9. This message is displayed when you try to combine more than 71 patterns.

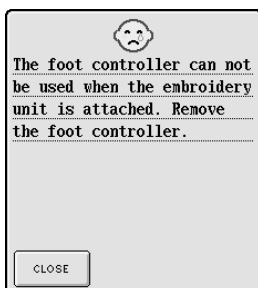

10. This message is displayed when you try to use the foot controller while the machine is in embroidery mode.

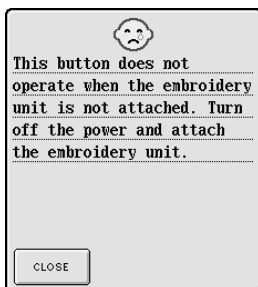

11. This message is displayed when **Embroidery** or **Embroidery Edit** is pressed while the machine is in utility stitch mode.

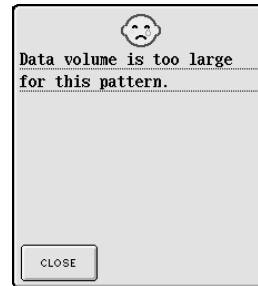

12. This message is displayed when the patterns you are editing take up too much memory, or if you are editing too many patterns for the memory.



13. This message is displayed when the "Start/Stop" button is pushed while the foot controller is installed.



14. This message is displayed when the "Start/Stop" button is pushed while the machine is in embroidery edit mode and a pattern is being edited.

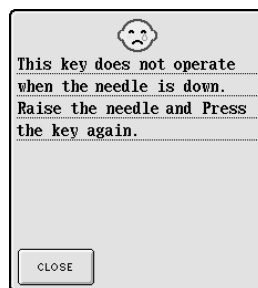

15. This message is displayed when a key on the LCD display is touched while the needle is in the down position.

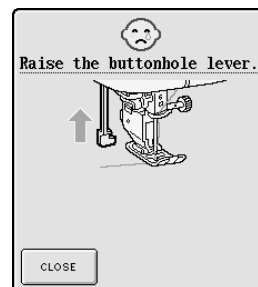

16. This message is displayed when the buttonhole lever is down, a stitch other than a buttonhole is selected, and the "Start/Stop" button or the "Reverse/Reinforcement Stitch" button is pushed.

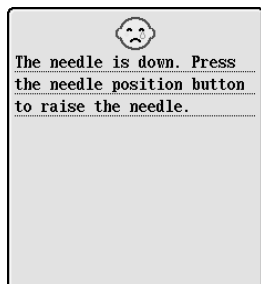

17. This message is displayed when the embroidery unit is attached and the power is turned on with the needle in the down position.

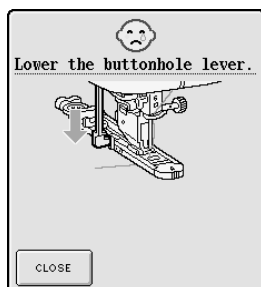

18. This message is displayed when the buttonhole lever is up, a buttonhole stitch is selected, and the "Start/Stop" button or "Reverse/Reinforcement Stitch" button is pushed.

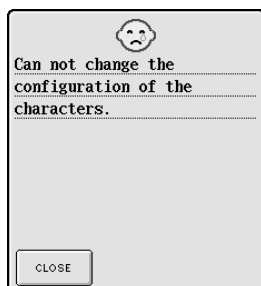

19. This message is displayed when there are too many characters and the curved character configuration is impossible.

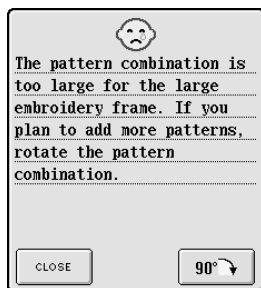

20. This message is displayed when the machine is in embroidery mode and the combined character pattern is too large for the embroidery frame. You can rotate the pattern 90 degrees and continue combining characters.

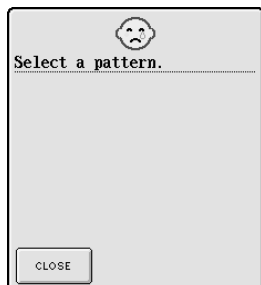

21. This message is displayed when there is no stitch or embroidery pattern selected and the "Start/Stop" button, the "Reverse/Reinforcement Stitch" button, or  is pressed.

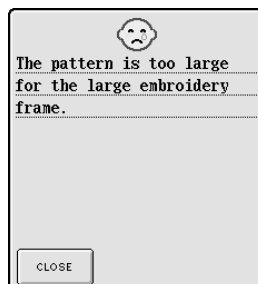

22. This message is displayed when the machine is in embroidery mode, and the character pattern combination is too large to fit in the embroidery frame.

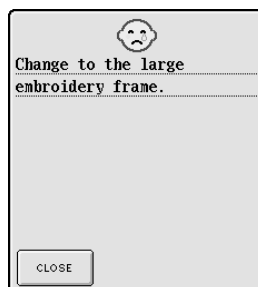

23. This message is displayed when the machine is in embroidery mode and the medium frame is attached, and the selected pattern does not fit in the medium frame.

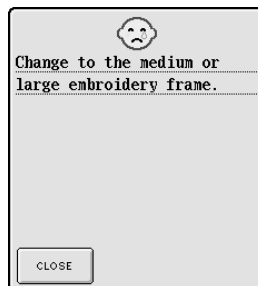

24. This message is displayed when the machine is in embroidery mode and the small frame is attached, and the selected pattern does not fit in the small frame.

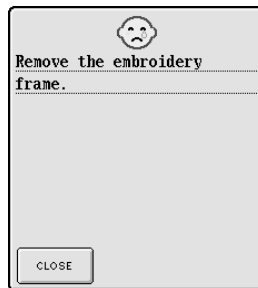

25. This message is displayed when the machine is in embroidery mode and the embroidery unit tries to initialize while the embroidery frame is attached.

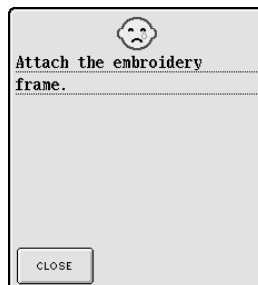

26. This message is displayed when the machine is ready to sew an embroidery pattern, and the "Start/Stop" button is pushed while the embroidery frame is not attached.

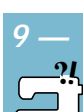

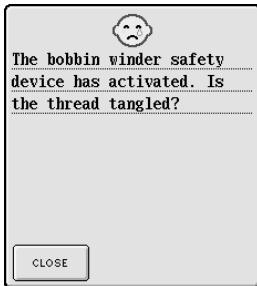

27. This message is displayed when the bobbin is being wound, and the motor locks because the thread is tangled, etc.



28. This message is displayed when the floppy disk is not formatted or is not formatted properly.



29. This message is displayed when the floppy disk can not be formatted.



30. This message is displayed when you try to save a pattern on a floppy disk, and the pattern can not be saved on that disk.



31. This message is displayed when the machine can not read the patterns on the floppy disk.

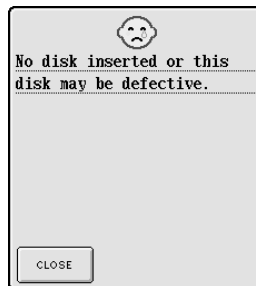

32. This message is displayed when the  is pressed without a floppy disk set in the machine.



33. This message is displayed when you try to save a pattern onto a write-protected floppy disk.

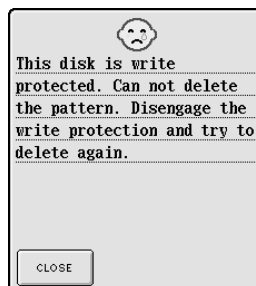

34. This message is displayed when you try to delete a pattern from a write-protected floppy disk.

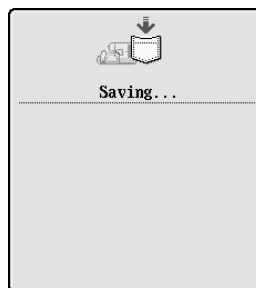

35. This message is displayed when the pattern is being saved.

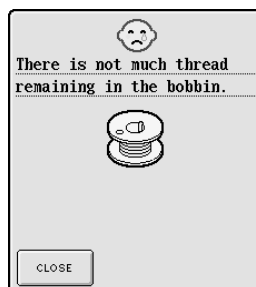

36. This message is displayed when the bobbin thread is running out.

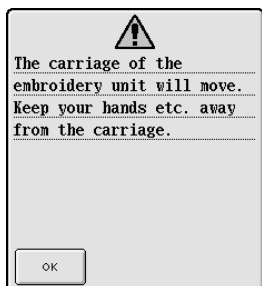
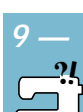

37. This message is displayed when the embroidery unit is initializing.

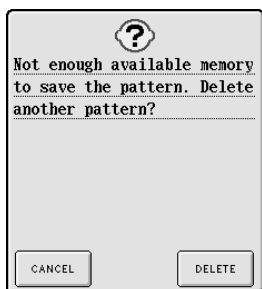

38. This message is displayed when the memory is full and the stitch or pattern can not be saved.



39. This message is displayed when a previously saved pattern is deleted.

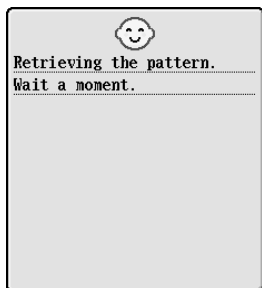

40. This message is displayed when the machine is retrieving a previously saved pattern while in embroidery edit mode.

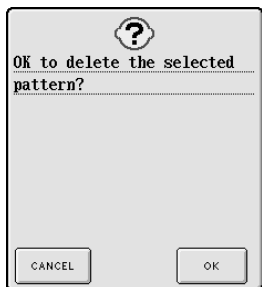

41. This message is displayed when, after selecting a pattern, **Utility Stitch**, **Character Decorative Stitch**, **Embroidery**, or **Embroidery Edit** is pushed and the pattern is about to be deleted.

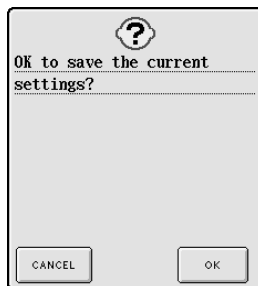

42. This message is displayed when the machine is in utility stitch mode, and **MEMORY** is pushed.

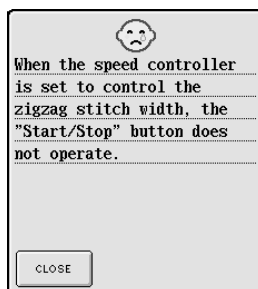

43. This message is displayed when the speed control lever is set to control the zigzag stitch width, and the "Start/Stop" button is pushed. Use the foot controller to operate the machine.

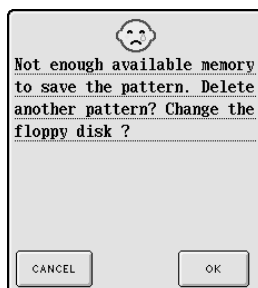

44. This message is displayed when there is not enough space on the floppy disk to save a selected pattern.

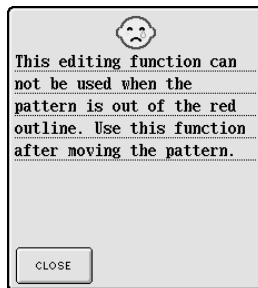

45. This message is displayed when the machine is in embroidery edit mode, and you try to use an editing function when the pattern is not completely within the red outline.

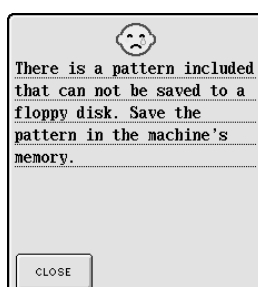

46. This message is displayed when you try to save a copyright protected pattern to a floppy disk. According to copyright laws, patterns that are illegal to reproduce or edit can not be saved to floppy disks. If this message displays, save the pattern in the machine's memory.

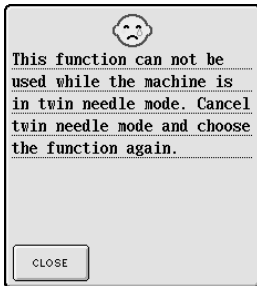

47. This message is displayed when the machine is in twin needle mode and a pattern that can not be sewn with the twin needle is selected.

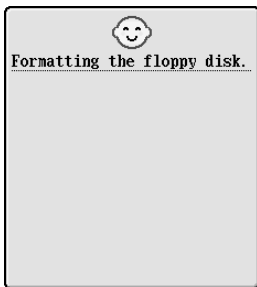

48. This message is displayed when formatting the floppy disk.

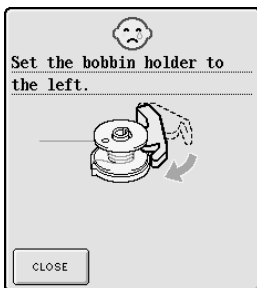

49. This message is displayed when the bobbin holder is at the right (original) position, and you try to press the bobbin winder button.

■ Alarm Sounds

If the operation procedure was correct, the machine will beep once. If the operation procedure was incorrect, the machine will beep twice or four times.

Note

If you want to turn the alarm off, press . See page 1-19 for more details.



1 —



2 —



3 —



4 —



5 —



6 —



7 —



8 —



9 —



Appendix

SPECIFICATIONS

	Item	Specification
Sewing Machine	Dimensions	47.0 cm (W) × 30.8 cm (H) × 25.3 cm (D)
	Case Dimensions	50.0 cm (W) × 31.5 cm (H) × 27.0 cm (D)
	Weight	11 kg (25 lb.) (with case: 12.5 kg (28 lb.))
	Sewing speed	70 to 850 stitches per minute
	Needles	Home sewing machine needles (HA × 130)
	Lamp power usage	12 V/5 W
Embroidery Unit	Dimensions	43.1 cm (W) × 12.2 cm (H) × 40.5 cm (D)
	Dimensions of machine with embroidery unit attached	66.1 cm (W) × 30.8 cm (H) × 40.5 cm (D)
	Weight	3 kg (7 lb.)



1 —



2 —



3 —



4 —



5 —



6 —



7 —



8 —



9 —



Index

4-hole buttons 3-62
7mm decorative stitch patterns 4-3
7mm satin stitch patterns 4-4
90 degree rotation key 5-44, 5-46

A

Accessories 1-8
Adjusting
 character/decorative stitch patterns 4-11
 edited patterns 6-30
 embroidery patterns after editing 6-18
 embroidery speed setting 5-41
 minor machine adjustments 9-5
 screen brightness 1-16, 9-1
 thread tension 2-13, 5-40
 touch panel 9-2
Alarm 1-19, 9-15
Aligning the left side 5-55
Alphabetical characters 4-6
 character/decorative stitches 4-6
 embroidery 5-11
 embroidery edit 6-5
Appliqué 3-37
 embroidery frame patterns 5-59, 5-60
 embroidery patterns 5-33
 quilts 3-31
 zigzag stitch 3-21
Array key 6-8, 6-15
Arrow keys
 for embroidery edit functions 6-8, 6-9
 for embroidery functions 5-26, 5-44
Automatic reinforcement stitching 1-14, 2-14, 4-14
Automatic thread cutting 1-14, 2-15, 4-14

B

Balance wheel 1-4
Ball point needle 1-45
Bar tacks 3-59
Basic embroidery method 5-30
Basic operation key 1-20, 1-22
Basic sewing
 character/decorative stitches 4-9
 utility stitches 2-1
Basting 3-19
Blind hem stitches 3-35
Bobbin
 pulling up bobbin thread 1-38

 runs out of thread 5-35
 setting 1-31
 winding 1-25, 1-29
Bobbin thread sensor 1-13, 5-19
Bobbin winder button 1-4
Button holder plate 3-54
Buttonholes 3-53
Button sewing 3-61
Buzzer 1-19

C

Centered zippers 3-67
Character/Decorative stitches 4-1
 checking combined patterns 4-26
 combining 4-18
 deleting 4-28
 retrieving 4-31
 saving 4-27
 selecting 4-2
Character/Decorative stitches key 1-14, 4-1
Character patterns 5-11
 changing color 5-48, 6-17
 changing configurations 6-15
 changing spacing 6-16
 connecting characters 5-56
 selecting for editing 6-5
Character spacing key 6-8, 6-16
Checking
 combined character/decorative stitch patterns 4-26
 position of embroidery patterns 5-27
Cleaning
 floppy disk drive heads 8-4
 LCD 8-2
 machine casing 8-2
 race and shuttle 8-2
Color
 changing color in character patterns 5-48, 6-17
 changing thread color 6-13
Combining patterns
 character/decorative stitch patterns 4-18
 with embroidery edit functions 6-20
Connecting characters in embroidery 5-56
Continuous sewing 4-17
Copyright information 5-1
Crazy quilt 3-21
Cross stitch 4-4



D

- Daisy stitch 3-49
- Darning 3-57
- Decorative stitch patterns 4-2
- Delete key 4-2, 4-7, 4-14, 6-8, 6-12
- Deleting
 - embroidery edit 6-12
 - mistakes 4-2, 4-7
 - previously saved pattern 4-28, 5-50, 6-33
- Density
 - changing density of a pattern 5-47
- Density key 5-44, 5-47, 6-8
- Display language 1-18
- Drawn work 3-50

E

- Editing
 - character/decorative stitches 4-13
 - embroidery 5-44
 - embroidery edit 6-8
 - MY CUSTOM STITCH™ 7-6
- Elastic attaching see Tape attaching
- Elastic zigzag stitches 3-22
- Elongation key 4-14, 4-16, 4-22
- Embroidery
 - aligning the left side 5-55
 - applications 5-55
 - basic method 5-30
 - basic steps 5-3
 - color order display 5-30
 - connecting characters 5-56
 - combined patterns 6-28
 - edges or corners 5-62
 - maximum speed setting 5-41
 - pattern's outline 5-58
 - revising patterns 5-44
 - ribbons or tape 5-62
 - selecting patterns 5-8
 - small fabrics 5-62
 - using a frame pattern to make appliqué 5-59, 5-60
- Embroidery basic operation key 1-20, 1-22
- Embroidery card 1-11, 5-1, 5-17
- Embroidery color order display 5-30
- Embroidery edit functions
 - changing the pattern's size 6-11
 - changing the thread color 6-13
 - deleting the pattern 6-12
 - embroidery edit screen key functions 6-8

- moving the pattern 6-9
 - rotating the pattern 6-10
- Embroidery edit key 1-14, 6-2
- Embroidery foot Q 1-8
 - attaching 5-4
- Embroidery frame
 - attaching to the embroidery unit 5-24
 - display of available frames 5-19, 5-21
 - removing 5-25
 - setting fabric in 5-22
 - types 1-9, 5-21
- Embroidery frame display 1-19, 5-43
- Embroidery key 1-14, 5-7
- Embroidery patterns
 - adjusting edited patterns 6-30
 - editing 6-8
 - changing a pattern's position 5-26
 - changing a pattern's size 5-45
 - checking the pattern's position 5-27
 - combining patterns 6-20, 6-28
 - patterns that use appliqué 5-33
 - previewing the pattern 5-28
 - revising 5-44
 - retrieving saved patterns 5-53, 6-36
 - saving edited patterns 6-32
 - selecting 5-8
 - selecting for editing 6-2
 - types 5-8
- Embroidery sheet 5-23
- Embroidery unit 1-2, 5-1
 - attaching 5-5
 - removing 5-7
 - storage case 1-2
- End key 6-8, 6-18
- Error messages 9-10
- Eyelet 3-63
 - sizes 3-64

F

- Fabric
 - needle/fabric/thread combinations 1-45
 - setting in an embroidery frame 5-22
- Fagoting 3-46
- Feed dog position switch 1-6
- Feed dogs 1-1
- Flat bed attachment 1-8
- Floppy disks 5-2, 5-18, 5-49, 6-32
 - cleaning 8-4
- Floral alphabet patterns 5-13

1 —



2 —



3 —



4 —



5 —



6 —



7 —



8 —



9 —



Frame patterns 5-15, 5-59, 5-60
 Free arm 1-5
 Foot controller 1-7
 Forward/Back key 5-36, 5-38, 5-44

G

Gimp thread 3-56

H

Hard case 1-2
 Heavyweight fabrics 1-45, 2-4
 Heirloom 3-49
 Hemstitching 3-49
 Horizontal mirror image key
 character/decorative stitches 4-14, 4-16
 embroidery 5-44, 5-46
 embroidery edit 6-8
 utility stitches 3-11

I

Included accessories 1-8

K

Key functions 1-14
 editing character/decorative stitches 4-14
 embroidery edit functions 6-8
 embroidery pattern revision 5-44
 Knee lifter 1-6

L

Lamp 1-19
 LCD 1-16
 adjusting 1-16, 9-1
 choosing display language 1-18
 viewing 1-13, 5-19
 Light bulb 8-1
 Lightweight fabrics 1-45, 2-4
 Lower threading see Bobbin winding
 Low shank adapter 1-9, 1-40

M

Machine operations key 1-20
 Machine settings key 1-19
 Main power switch 1-12
 Maintenance key 1-20, 1-23
 Manual memory key 1-15, 3-12
 Memory key 4-14, 4-27, 5-44, 5-49

Mirror image key 1-14, 3-11, 4-14, 4-16,
 4-21, 5-44, 5-46, 6-8

Moving a pattern 5-26, 6-9
 Multi color key 5-44, 5-48, 6-8
 Multi-directional sewing 3-65
 Multi-thread stand 1-10
 MY CUSTOM STITCH™ 7-1

N

Needle 1-45
 changing 1-43
 changing position 3-18
 checking 1-43
 needle/fabric/thread combinations 1-45
 mode display 1-13
 twin needle 2-5
 Needle clamp screw 1-44
 Needle clamp thread guide 1-34
 Needle mode selection key 1-15, 2-5, 4-14
 Needle plate cover 5-29
 "Needle Position" button 1-3, 1-19
 Needle stopper 1-44
 Needle stop position 1-19
 Needle threader lever 1-35

O

One point patterns 5-9
 Opening screen display 1-19
 Operation buttons 1-3
 Operation guide key 1-20
 Optional accessories 1-10
 Overcasting 3-23
 elastic zigzag stitches 3-22
 zigzag stitches 3-20

P

Patchwork stitches 3-42
 Pattern explanation key 1-24
 Pattern position
 changing 5-26
 checking 5-27
 Pattern select key 6-8, 6-26
 Piecing 3-29
 Power cord 1-12
 Presser foot
 changing 1-39
 code display 1-13, 5-19
 types 1-8
 Presser foot dial 1-6



Presser foot holder 1-42
 Presser foot lever 1-4
 Previewing the completed pattern 5-28
 Principal parts 1-1
 principal parts key 1-20, 1-22

Q

Quilting 3-28

R

Race 8-2
 Reset key 1-15, 3-12
 Retrieving from memory
 character/decorative stitch patterns 4-31
 edited patterns 6-36
 embroidery patterns 5-53
 MY CUSTOM STITCH™ designs 7-13
 Return key 5-44
 “Reverse/Reinforcement Stitch” button 1-3, 2-3
 Revising embroidery patterns 5-44
 colors of character 5-48
 density 5-47
 horizontal mirror image 5-46
 rotating 5-46
 size 5-45
 Rotate key 5-44, 5-46, 6-8, 6-10
 Rotating patterns
 1 degree rotation 6-10
 90 degree rotation 5-46, 6-10

S

Satin stitch patterns 4-3
 Saving
 character/decorative stitch patterns 4-27
 embroidery edited patterns 6-32
 embroidery patterns 5-49
 MY CUSTOM STITCH™ designs 7-11
 utility stitch settings 3-12
 Scallop stitches 3-41
 Screen see LCD
 Selecting
 character/decorative stitches 4-1
 embroidery patterns 5-8
 embroidery patterns to edit 6-2
 utility stitches 3-9, 3-13
 Setting key 1-19
 Sewing
 basic sewing 2-1
 buttons 3-61

character/decorative stitches 4-8
 continuously 4-17
 curves 2-3
 embroidery patterns 5-29
 lightweight fabrics 2-4
 heavyweight fabrics 2-4
 single stitches 4-17
 zippers 3-67, 3-68

Sewing screen (embroidery) 5-19
 Sewing speed controller 1-4, 1-19, 3-34
 Sewing type selection key 1-14, 3-13
 Shelltuck stitches 3-39
 Shuttle 8-2
 Side cutter 1-8, 3-25
 Side zippers 3-68
 Single/repeat sewing key 4-14, 4-17
 Size key 5-44, 5-45, 6-8, 6-11
 Size selection key 4-14, 4-15, 4-20
 Smocking stitches 3-44
 Specifications A-1
 Spool cap 1-9, 1-25, 1-29, 1-33
 Spool net 1-9, 1-37
 Stabilizer material 1-10, 5-20
 “Start/Stop” button 1-3
 Starting point key 5-44, 5-55
 Step stitch patterns 4-23
 Stitch selection display 1-14, 3-10
 Stitch settings
 automatic reinforcement stitching 2-14
 automatic thread cutting 2-15
 saving 3-12
 stitch length 1-15, 2-9
 stitch width 1-15, 1-19, 2-8, 3-34
 stitch width/length settings table 2-10
 thread tension 2-13
 Stitch width and stitch length key 2-8, 4-14
 Straight stitches 3-16, 3-65
 Supplemental spool pin 1-5, 1-29, 2-6

T

Take-up lever 1-34
 Tape attaching 3-22, 3-47
 Thread
 character/decorative stitches 4-8
 embroidery 5-29
 utility stitches 1-45
 Thread color changing 6-13
 Thread color display 5-42
 Thread cutter 1-3, 2-2



“Thread Cutter” button 1-3
Thread palette key 6-8, 6-13
Thread tension
 embroidery 5-40
 utility stitches 2-13
Thread tension key 1-15, 2-13, 4-14, 5-40,
 5-44
Top cover 1-5
Trial key 5-27, 5-44
Troubleshooting 9-1, 9-4, 9-5
Twin needle 2-5

U

Uppercase/lowercase 4-6
Upper threading 1-32
Utility decorative stitch patterns 4-5
Utility stitches
 mirror image 3-11
 quick reference table 3-1
 selecting 3-9, 3-13
 stitch width/length settings table 2-10
Utility stitch key 1-14, 3-9

V

Vertical mirror image key 4-14, 4-16

W

Walking foot 1-8, 1-40

Z

Zigzag stitches 3-20, 3-65
Zipper insertion 3-67, 3-68



ENGLISH
114-200
191200-011
0008
Printed in Japan