



# 5-IN-1 WIRELESS WEATHER STATION WITH WI-FI® AND SOLAR PANEL USER GUIDE

LOWSC510SWB



Thank you for purchasing the **Logia™ 5-in-1 Wireless Weather Station with Wi-Fi® and Solar Panel**. This User Guide is intended to provide you with guidelines to ensure that operation of this product is safe and does not pose risk to the user. Any use that does not conform to the guidelines described in this User Guide may void the limited warranty.

Please read all directions before using the product and retain this guide for reference. This product is intended for household use only. It is not intended for commercial use.

This product is covered by a limited one-year warranty. Coverage is subject to limits and exclusions. See warranty for details.

## ■ TABLE OF CONTENTS

SAFETY PRECAUTIONS .....	3
PRODUCT FEATURES .....	4
PACKAGE CONTENTS .....	5
PRODUCT OVERVIEW .....	6
LCD DISPLAY OVERVIEW .....	7
WIRELESS 5-IN-1 OUTDOOR SENSOR OVERVIEW .....	8
INSTALLATION INSTRUCTIONS .....	9
SETTING UP THE WIRELESS 5-IN-1 OUTDOOR SENSOR .....	10
SETTING UP THE WEATHER CONSOLE .....	12
SETTING UP WI-FI® CONNECTION .....	14
CREATE AND SYNC YOUR WEATHER SERVER ACCOUNT .....	18
UPDATING THE FIRMWARE .....	21
OPERATING INSTRUCTIONS .....	22
TEMPERATURE .....	24
WIND .....	26
WEATHER .....	28
PRESSURE .....	29
RAIN .....	30
MAX/MIN .....	30
HISTORY .....	31
CARE AND MAINTENANCE .....	33
TROUBLESHOOTING .....	34
SPECIFICATIONS .....	35
LIMITED WARRANTY TO ORIGINAL CONSUMER .....	38

## ■ SAFETY PRECAUTIONS

**WARNING! Please read and understand all safety precautions, operating instructions, and care/maintenance instructions before operating this appliance. Keep this manual for future reference.**

- This product is not a toy. Keep out of the reach of children.
- This product is not to be used for medical purposes or for public information.
- Do not clean the unit with abrasive or corrosive materials.
- Do not place the appliance near open flames or heat sources. Fire, electric shock, product damage, or injury might occur.
- Only use fresh batteries in the product. Do not mix new and old batteries together.
- Do not disassemble, alter, or modify the product.
- Only use attachments or accessories specified by the manufacturer with this product.
- Do not submerge the display console in water. Dry the product with a soft cloth if liquid spills on it.
- Do not subject the unit to excessive force, shock, dust, extreme temperature, or humidity.
- Do not cover or block the ventilation holes with any object.
- The console of this product is intended to be used indoors only.
- This product is only suitable for a mounting height that is less than 6.6 ft. (2 m).
- Do not tamper with the unit's internal components. Tampering with the product will void the warranty.
- The indoor sensor of this product should not be placed in direct sunlight, rain, snow, or other weather conditions.

### QUESTIONS OR PROBLEMS? CONTACT US!

Email: [info@supportcbp.com](mailto:info@supportcbp.com) or call: 1-833-815-0568  
[www.logiaweatherstation.com](http://www.logiaweatherstation.com)

## ■ PRODUCT FEATURES

1. Wireless 5-in-1 weather sensor measures wind speed, wind direction, rainfall, temperature, and humidity.
2. No calibration needed! The product is fully pre-calibrated and mostly assembled; all you need to do is install it and sync with the included display console.
3. Provides precise weather and environmental information right in your own backyard.
4. Color LCD display automatically dims to match room lighting.
5. Alerts you to excessively high/low indoor or outdoor temperatures or humidity, high wind speeds, extreme changes in barometric pressure, high heat indexes, low wind chills, and more.
6. Syncs with installed Wi-Fi® and online weather servers (Weather Underground and Weathercloud) to help you store and track weather data in your area.

## PACKAGE CONTENTS

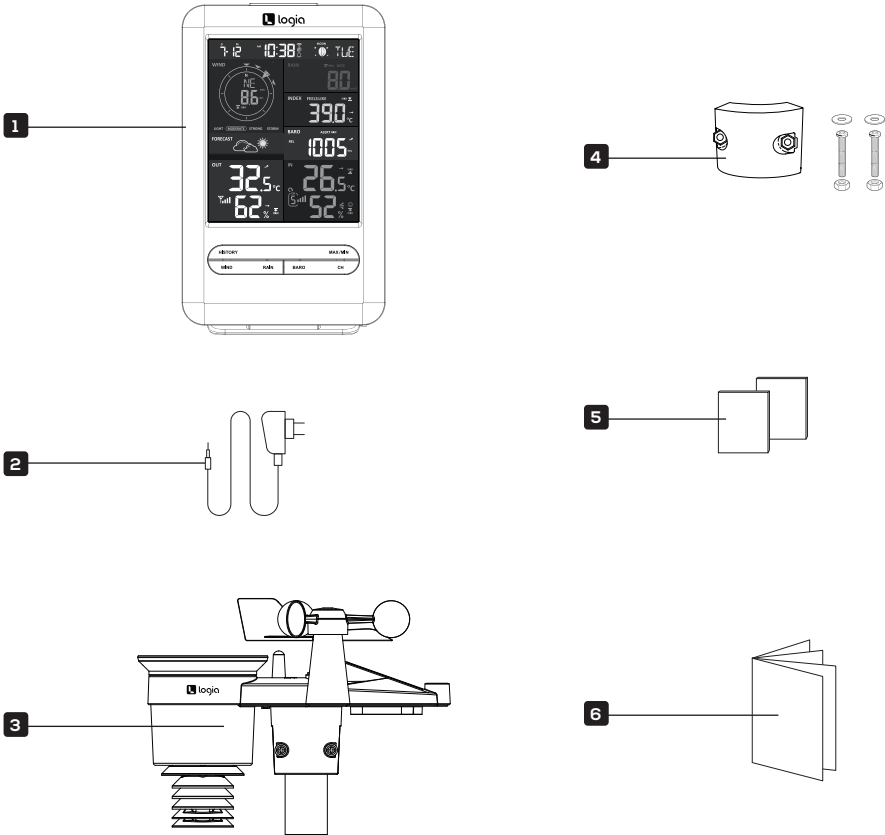

1. Display console
2. Console power cord
3. Wireless 5-in-1 outdoor sensor
4. Mounting clamp with two (2) screws
5. Two (2) rubber pads
6. User guide

# PRODUCT OVERVIEW

## CONSOLE LCD DISPLAY OVERVIEW

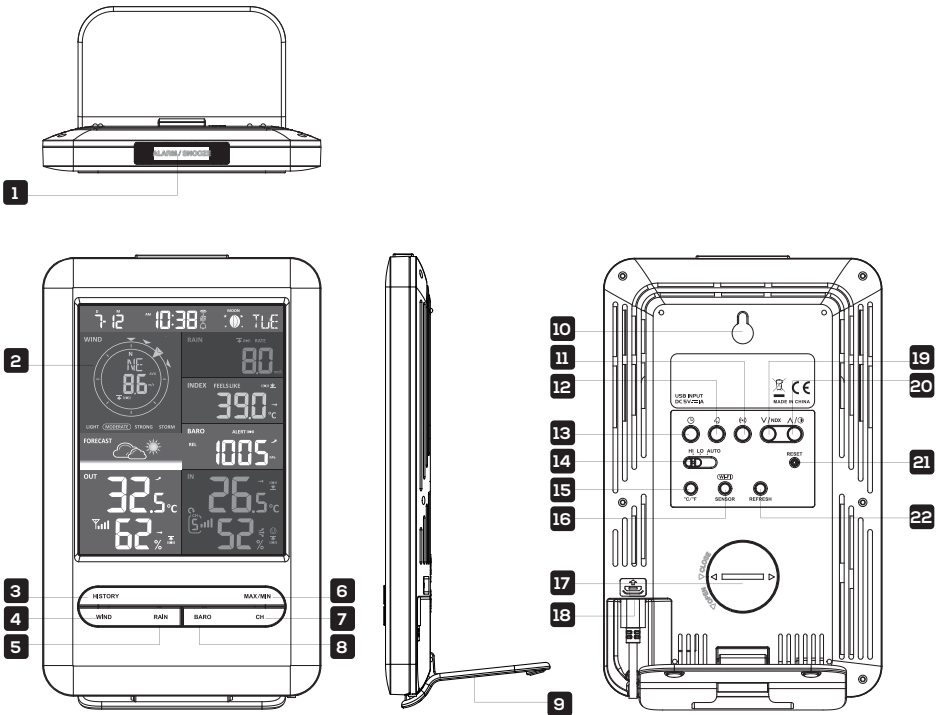

- |                        |                                |                         |
|------------------------|--------------------------------|-------------------------|
| 1. ALARM/SNOOZE button | 8. BARO button                 | 15. °C / °F key         |
| 2. LCD display         | 9. Stand                       | 16. WI-FI/SENSOR button |
| 3. HISTORY button      | 10. Wall mounting holder       | 17. Battery compartment |
| 4. WIND button         | 11. ALERT button               | 18. Power jack          |
| 5. RAIN button         | 12. ALARM button               | 19. DOWN/INDEX button   |
| 6. MAX/MIN button      | 13. CLOCK SET button           | 20. UP/CONTRAST button  |
| 7. CHANNEL button      | 14. Display brightness setting | 21. RESET key           |
|                        |                                | 22. REFRESH button      |

## LCD DISPLAY OVERVIEW

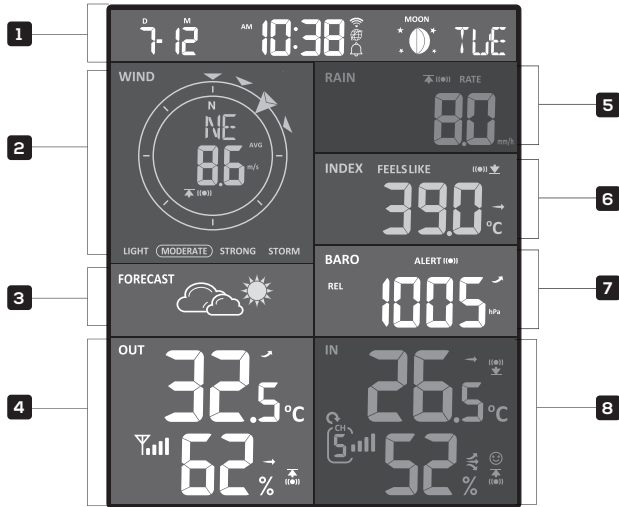

1. Time, date, & moon phase
2. Wind direction & speed
3. Weather forecast
4. Outdoor temperature & humidity
5. Rain data
6. Feels like index
7. Barometric pressure
8. Indoor temperature & humidity (CH)

## ■ WIRELESS 5-IN-1 OUTDOOR SENSOR OVERVIEW

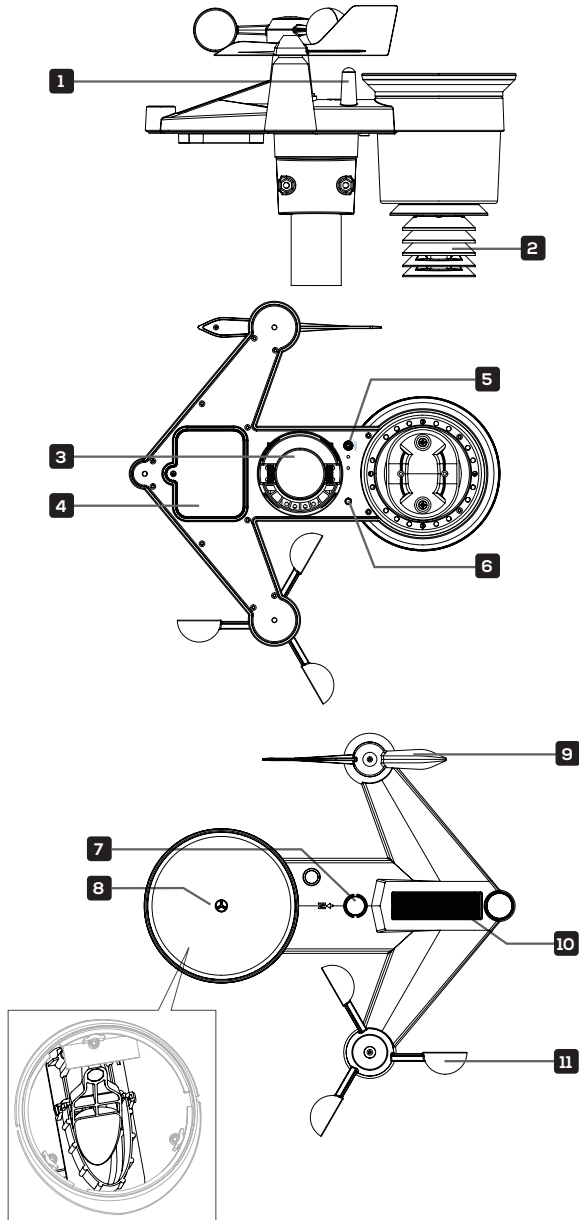



1. Antenna
2. Radiation shield & hygro-thermo sensor
3. Mounting parts
4. Battery door
5. RESET button
6. Transmission status LED
7. Bubble level gradienter
8. Rain collector
9. Wind direction vane
10. Solar panel
11. Wind speed cups

## ■ INSTALLATION INSTRUCTIONS

The display console can pair up with one (1) wireless 5-in-1 outdoor sensor and up to seven (7) wireless indoor sensors. **(NOTE: This product does not include an indoor sensor.)**

### RECOMMENDED TOOL

Screwdriver

## ■ SETTING UP THE WIRELESS 5-IN-1 OUTDOOR SENSOR

The wireless 5-in-1 outdoor sensor measures wind speed, wind direction, rainfall, temperature, and humidity.

### SETTING UP RAIN COLLECTOR

1. Align the notches on the funnel with the lock grooves inside the rain collector.
2. Insert the funnel in the rain collector and screw on tight to lock it in place.

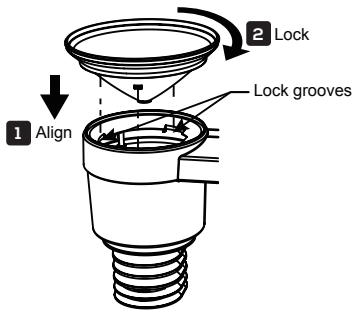

### INSTALLING THE BATTERIES

1. Unscrew the battery door at the bottom of the 5-in-1 outdoor sensor.
2. Insert three (3) AA batteries (not included) according to the +/- polarity labeled in the compartment.
3. Screw the battery door back onto the compartment.

**NOTE:** The LED light will flash red every 12 seconds.

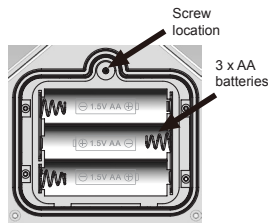

### MOUNTING SENSOR ON POLE

1. Pick a location for the 5-in-1 outdoor sensor that is open with no obstructions.
2. Set the sensor so the rain collector faces north and solar panel faces south.

3. Secure the sensor onto a mounting post or pole (not included) using the mounting clamp (included).
4. Add rubber pads onto mounting clamp before fastening the mounting clamp onto the sensor.
5. Tighten the mounting clamp using included screws onto the bottom of the sensor once it is on a pole.

**NOTE: Place sensor a minimum of 6.6 ft (2 m) off the ground on a steel post or pole with a 1.4" - 1.6" (35 - 40 mm) diameter.**

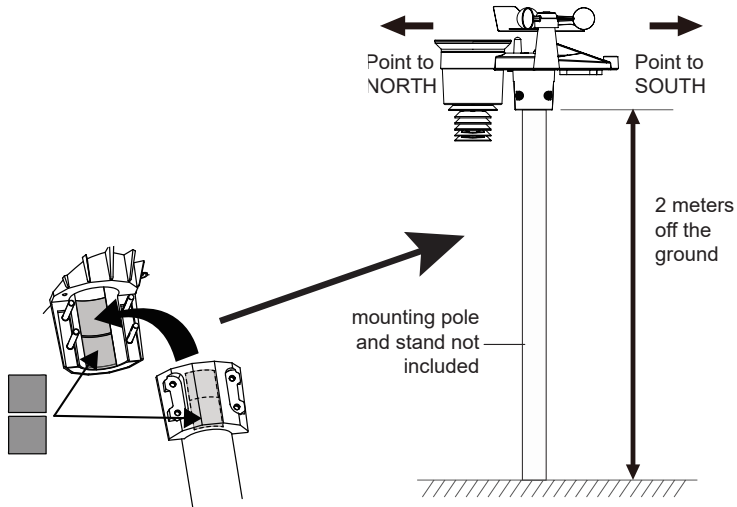

### **POINTING THE WIRELESS 5-IN-1 OUTDOOR SENSOR TO SOUTH (OPTIONAL)**

The outdoor wireless weather sensor is calibrated to be pointed north for maximum accuracy. However, for your convenience, if you are a user located in the Southern Hemisphere, you can use the sensor with the wind vane pointing south.

1. Mount and install the wireless weather sensor with the wind meter end pointed South, instead of North. (Please refer to Mounting Sensor on Pole for mounting instructions.)
2. Select "S" in hemisphere section of the setup UI setup page. (Please refer to Setting Up Weather Server Connection section for setup details)
3. Press the APPLY icon to confirm and exit.

**NOTES: Changing the hemisphere setting will automatically switch the direction of the moon phases on the display.**

**Pointing the wireless weather sensor toward the south will allow maximum sunlight on the solar panel, especially during the winter season in the Southern Hemisphere.**

## ■ SETTING UP THE WEATHER CONSOLE

Your console can pair up with one (1) wireless 5-in-1 outdoor sensor and up to seven (7) wireless indoor sensors. (No indoor sensors included.)

### INSTALLING THE BACKUP BATTERIES

1. Remove the battery door on the rear of the console.
2. Insert a new button battery.
3. Replace the battery door.

**NOTE:** The backup battery can assist with backing up the time & date, MAX/MIN data, weather records from the past 24 hours, alert settings, the offset value of weather data, and the sensor(s) channel history. The built-in memory will backup router and weather server settings.

### POWERING UP THE CONSOLE

1. Plug the power adapter into the power jack located on back of the console.
2. Once the console is turned on, it will automatically enter pairing mode.

**NOTE:** If the LCD display does not turn on, use a pin or other small object to press the RESET button on back of the console.

### ATTACHING THE STAND

**NOTE:** The weather console can be mounted to a wall using a single hook or screw, or can stand on a table, desk, or shelf using the included stand.

1. Line up the stand so that the bottom bracket clips into the bottom mount on the console.
2. Lift the leg of the stand until the top bracket clips into the top mount on the console.

### SETTING THE LCD DISPLAY ANGLE

While in normal operating mode, use the UP or DOWN key to adjust the viewing angle of the LCD display to fit your viewing needs.

### **PAIRING THE WIRELESS 5-IN-1 SENSOR AND INDOOR SENSOR**

1. Once your display console powers on, it should automatically search for and connect to the wireless weather sensors. If the console does not connect within the first 15 minutes, refer to the following section, Changing Batteries and Manual Pairing of Sensor, for instructions on manual pairing.
2. You will see the icon of an antenna blinking in the temperature and humidity (outdoor) section of the display.
3. Once the pairing process completes, the antenna icon will appear solid (not blinking), and the readings for outdoor temperature and humidity, wind speed, wind direction, and rainfall will appear in their designated sections of the LCD display.

### **RESET AND FACTORY HARD RESET**



To reset the console and start again, press the RESET button once. To hard reset the console and revert to factory settings, press and hold the RESET button on the console for six (6) seconds.

### **RE-PAIRING SENSORS**

If the connection fails or the console is reset, press the WI-FI/SENSOR button once for the console to enter pairing mode. The console will re-register all the sensors that have already been registered to it before. (i.e. the console will not lose the connection of the sensors that you have paired up before.)

### **CHANGING BATTERIES AND MANUAL PAIRING OF SENSOR**

Whenever you change the batteries of the wireless indoor or 5-in-1 weather sensor, re-pairing must be done manually.

1. Change all the batteries in the sensor.
2. Press the WI-FI/SENSOR button on the console to enter pairing mode.
3. Press the RESET button on the wireless indoor or 5-in-1 weather sensor.

### **PAIRING ADDITIONAL WIRELESS SENSORS**

1. Press the WI-FI/SENSOR button once on the console to enter pairing mode.
2. Press the RESET button on the new sensor and wait for a few minutes for the new sensor to pair to the console.

**NOTE:** Channel number of an indoor sensor must not be the same as another indoor sensor. Please refer to Setting Up the Wireless Indoor Hygro-thermo Sensor section for details.

## ■ SETUP INSTRUCTIONS

### SETTING UP WI-FI® CONNECTION



When you first power up the console or press and hold the WI-FI/SENSOR button for six (6) seconds, the console LCD display will show the letters “AP” and an  icon to signify that it has entered Access Point (AP) mode. At this time it will be ready for the Wi-Fi® settings to be adjusted.

Use your smartphone, tablet, or computer to connect to the console via Wi-Fi® by following these steps:

1. On PC, open your Wi-Fi® network settings. On Android™ or iOS devices, go to settings menu and then select Connections/WI-FI to open the network settings.
2. Locate the display console’s SSID from the list. It should appear as PWS-XXXXXX (where all the X’s are integers) in the list. Tap on the SSID to connect. This step will take several seconds.
3. Once you are connected to the display console, open up your internet browser, and enter the following address into the address bar: <http://192.168.1.1> (make sure to include the **http://** or else the web browser may interpret the address as a search query). We recommend using the latest version of reputable web browsers.

### WI-FI® CONNECTION STATUS

The following icons on the LCD display screen show the Wi-Fi® status:

		
Solid: the display console is connected to your wireless router	Flashing: the display console is attempting to connect to your wireless router	Flashing: the display console is currently in AP (access point) mode

### SETTING UP WEATHER SERVER CONNECTION

Once you are connected via Wi-Fi® to the display console and have opened the settings page at <http://192.168.1.1>, enter the following information into the web interface setup page. If you have chosen not to use Weather Underground or Weathercloud servers, leave the check boxes unchecked.

SETUP page

SETTINGS

SETUP ADVANCED

Language: English

WiFi Router setup

Search Router: ROUTER\_A

Add Router

Security type: WAP2

Router Password: \*\*\*\*\*

Weather server setup

Wundergruind

Station ID: WDw124

Station key: \*\*\*\*\*

Weathercloud

Station ID: IPACIR23Wc

Station key: \*\*\*\*\*

URL: http://WAC.com

Station ID: IDCR21w1

Station key: \*\*\*\*\*

Mac address 00:0E:C6:00:07:10

Time server setup

Server URL: nist.time.gov

Time Zone: 0:00

Location for sunrise / sunset

\*Latitude: 0.0000 North

\*Longitude: 0.0000 East

Hemisphere: N

Firmware version: 1.00

Apply

Press "ADVANCED" icon to Advanced page

Select setup UI display language

Press to search router

Press to allow add router manually

Select router (SSID) for connection

Manually enter the SSID if not on list

Select router's security type (usually WAP2)

Router's password (leave blank if the Security type is "Open")

Enter new Station ID and Station key that assigned by Wundergruind

Enter new Station ID and Station key that assigned by weathercloud

Reserved for validated weather server, detail please consult with your retailer

Enter new Station ID and Station key that assigned by the corresponding weather server

Select time server

Select time zone of your location

Enter the Latitude value

Enter the Longitude value

Select the direction (e.g. EU countries Longitude is East and US is West)

Select the sensor located hemisphere (e.g. US and EU countries are also "N", Australia is "S")

Press to complete the setting

**NOTES:** When the Wi-Fi® setup is complete, your computer or mobile device will return to the default Wi-Fi® connection. If it does not, simply open your device's wireless network settings and manually reconnect.

While in AP mode, you can press and hold the WI-FI/SENSOR button for six (6) seconds to exit AP mode. The display console will simply restore the previous AP settings.

## TIME ZONE

To automatically set the time display to your time-zone, change the time zone in Time server setup section of the SETUP page from '0:00' (default) to your time zone (e.g.+1:00 for Germany).

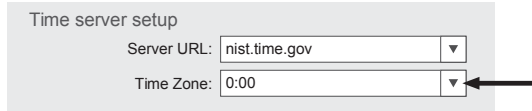

Time server setup

Server URL: nist.time.gov ▼

Time Zone: 0:00 ▼

## TIME SERVER CONNECTION STATUS

Once the display console has connected to the internet, it will attempt to connect to the internet time server to obtain the UTC time. Once the connection is successful and the time has been updated, the  icon will appear below the Wi-Fi® icon on the LCD.

To display the correct time for your specific time zone, you'll need to change the time zone in the CLOCK setting mode from 00 (default) to your specific time zone (e.g. -5 for EST). If you don't know your time zone, you can look it up online.

1. In normal operating mode, press and hold the CLOCK button for two (2) seconds to enter the clock setting menu.
2. Press the UP or DOWN buttons to adjust the time zone, then press and hold the CLOCK button for two (2) seconds to confirm and exit the menu. Please refer to the Setting the Time section of the manual on page 22 for details of other available clock settings.

The time will automatically sync with the internet time server at 12:00AM and 12:00PM per day. Also you can press the REFRESH button to get the internet time manually within one (1) minute.



## ADVANCED SETTINGS VIA WEB INTERFACE

Once you are connected via Wi-Fi® to the display console and have opened the settings page at <http://192.168.1.1>, clicking on the tab that says ADVANCED will open the following page. This page will allow you to set and view specific calibration data of your display console, and also update the firmware if you are on PC.



The screenshot shows the 'ADVANCED' settings page. At the top, there are 'SETUP' and 'ADVANCED' tabs. The main content is divided into several sections:

- Temperature:** Includes 'Indoor', 'Outdoor', and 'CH 1-7' calibration options. Each has a numerical input box and a 'Current offset' value. A unit dropdown is set to '°C'. A range is shown as '-20.0 ~ 20.0°C' and '-36.0 ~ 36.0°F (Default: 0.0)'.
- Humidity %:** Includes 'Outdoor' and 'CH 1-7' calibration options. Each has a numerical input box and a 'Current offset' value. A range is shown as '-20 ~ 20 (Default: 0.0)'.
- Pressure:** Includes 'Absolute Pressure Offset' and 'Relative Pressure Offset' with numerical input boxes and 'Current offset' values. A unit dropdown is set to 'hpa'. A 'Setting Range' is shown as '-560 ~ 560hpa / -16.54 ~ 16.54inHg / -420 ~ 420mmHg'.
- Sensors:** Includes 'Rain gain', 'Wind speed gain', 'Wind direction', 'UV gain', and 'Light gain', each with a numerical input box and 'Current gain' value. Ranges are provided for each.
- Firmware:** Shows 'Firmware version: 1.00' and 'Browse' and 'Upload' buttons.

Annotations on the left side of the image point to specific features:

- 'Press "SETUP" icon to Setup page' points to the SETUP tab.
- 'Select setting unit' points to the Temperature unit dropdown.
- 'Outdoor and Ch 1-7 temperature calibration section' points to the Outdoor and CH 1-7 temperature calibration options.
- 'Pressure calibration section' points to the Absolute and Relative Pressure Offset options.
- 'Current firmware version' points to the Firmware version text.

Annotations on the right side of the image provide additional context:

- 'Outdoor and Ch 1-7 humidity calibration section' points to the Outdoor and CH 1-7 humidity calibration options.
- 'Select setting unit' points to the Pressure unit dropdown.
- 'Current offset value is the value that you set before to offset the pressure reading.' points to the Current offset values for Pressure.
- 'The rain, wind speed, UV and Light calibration use gain method. The wind direction is +/- 10 offset.' points to the gain values for the sensors.
- 'The firmware update function only available in PC web browser' points to the Upload button.

## CALIBRATION

1. You may enter or change the offset and gain values for different measurement parameters while viewing the current offset and gain values next to the corresponding boxes.
2. Once you have completed your calibrations, press the **Apply** button on the SETUP tab.
3. The current offset value will update to show the value that you entered (instead of the default value). If you want to change the value, you can enter a new value in the box beside the number (as in step 1). To update the value, again, press **Apply** in the SETUP tab.

**NOTE:** We do not recommend calibration of most values with the exception of Relative Pressure, which must be correctly calibrated to reflect your distance above sea level to account for altitude effects.

## ■ CREATE AND SYNC YOUR WEATHER SERVER ACCOUNT

Your display console can upload weather data to Weather Underground and/or Weathercloud via your Wi-Fi® router.

**NOTE:** Logia™ does not own Weather Underground or Weathercloud, and these instructions are liable to change without notice due to changes in either website.

### CREATE YOUR WEATHER UNDERGROUND ACCOUNT

1. Make sure your display console is connected to your Wi-Fi® network, as outlined in brief below. Detailed steps are available in the Setting up Wi-Fi® Connection segment on page 14 of this user guide. The display console must be connected to the Wi-Fi® network in order to communicate with Weather Underground.
  - a. Press and hold the WI-FI/SENSOR button for six (6) seconds to put your display console into AP mode.
  - b. Open your phone, tablet, or computer's wireless settings to search for a wireless network.
  - c. Locate the display console's SSID in the list and select it.
  - d. Once connected, open up your device's web browser and enter <https://192.168.1.1>
2. Visit the Weather Underground website at <https://www.wunderground.com> and click the link that says "JOIN". Follow the instructions to create an account.

**NOTE:** Please use a valid email address to register your account.

3. Once you have created your account and completed the email validation process, return to the Weather Underground website. Click the dropdown link at the top of the site that says MORE, and then select Add Weather Station from the dropdown menu.
4. Follow the instructions on screen to enter your weather station information. Step 2 will ask you to enter a name for your weather station (get creative if you want, but don't forget the name you gave it!) and choose your station hardware (choose "other"). Once you complete this section, click Submit to generate your unique Station ID and key.
5. Write down or screenshot your Station ID and Station Key/Password for reference and to complete the setup process.

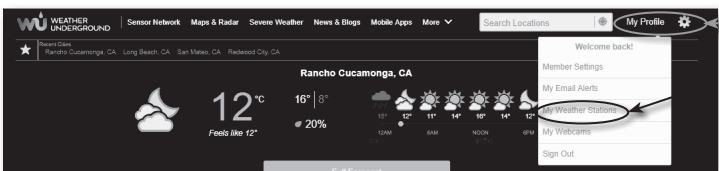
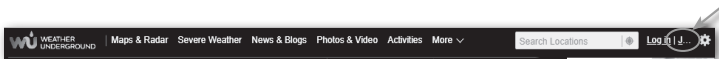

**Add a New pws**

TYPE LOCATION DETAILS DONE

Tell Us More About Your Device 75%

(1) Name (Required)  
 Enter Your Device a Name

(2) Device Hardware (Required)  
 Select device hardware

(2) Surface Type:  
 Select device surface

(2) Associate Webcam:  
 Select Webcam

(2) Height Above Ground:  
 Enter Above Ground

**You Make Our Forecasts More Accurate. We Respect Your Privacy**  
 Contribute to the Weather Underground community by sharing some information about yourself and your sensor. We use this information to manage your account and to improve the experience from the Weather Underground community. We may also share certain data for commercial purposes, such as your sensor location.  
 Learn more about how we take your privacy seriously

(3) (Required)  
 I Accept  I Deny

Email Preferences:  
 I would like to receive PWS notifications

(4) Back Next

**Registration Complete!** 100%

Congratulations! Your personal weather station is now registered with Weather Underground.

Enter the information below to your weather station software.

Your Station ID: **KCOARVAD281**

Your Station Key: **s1kgFvGZ**

Configure Your Software

View Devices

**CREATE YOUR WEATHERCLOUD ACCOUNT**

1. Visit the Weathercloud website at <https://www.weathercloud.net> and enter your information in the box that says Join Us Today. Follow the instructions to create an account.

**NOTE:** Please use a valid email address to register your account.

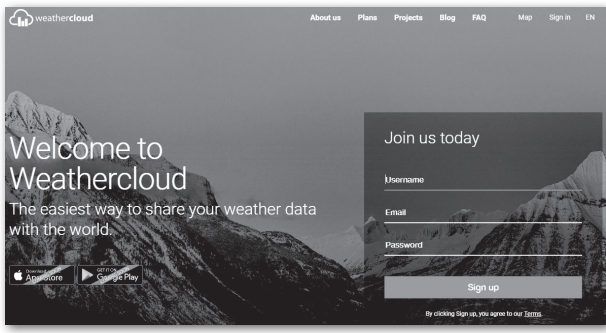

2. Once your account is created, sign into it, and then click +New to add a new device.

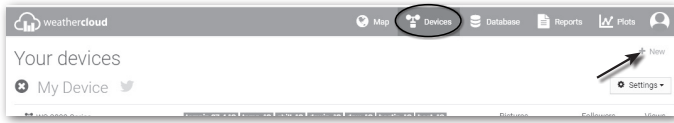

3. Enter all the requested information into the Create New Device page. When presented with the **Model** selection box, choose **LOWSC510SWB** Series under the **Logia** section. When presented with the **Link Type** selection box, choose **Pro Weather Link**. Once you have completed this section, click **Create**.

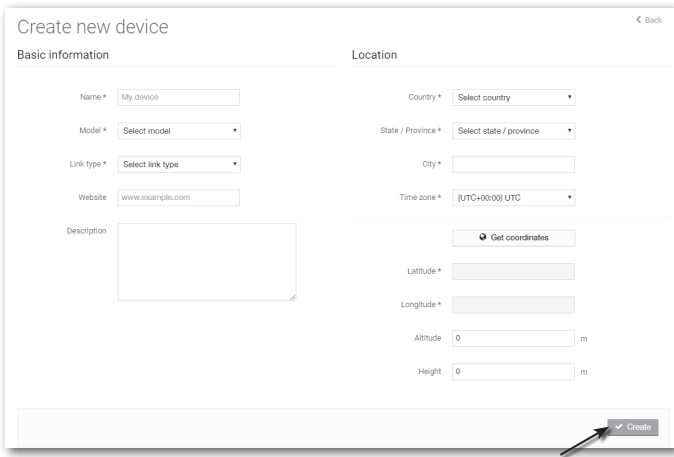

4. Write down or screenshot your Weathercloud ID and Station Key/Password for reference and to complete the setup process.

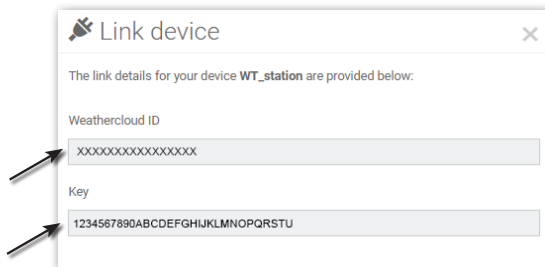

## VIEW YOUR WEATHER DATA IN WEATHER UNDERGROUND

To view your weather station data live via PC or mobile web browser, visit <http://www.wunderground.com>, and then enter the Station ID you were provided during account setup in the search box. Your weather data will show up on the next page. Alternately, you can log in to your Weather Underground account to view and download the recorded data from your weather station.

You can also check the Weather Underground website to learn more about their mobile app for Android™ and iOS.

## VIEW YOUR WEATHER DATA IN WEATHERCLOUD

1. To view your weather station data live via PC or mobile web browser, visit <http://www.weathercloud.net> and sign into the account you created.
2. Click on the tab at the top of the page titled Devices.
3. Click on the Settings menu at the top right of the page, and select the option View.
4. Click on either Current, Wind, Evolution, or Inside to view your weather station's data.

## ■ UPDATING THE FIRMWARE

This display console supports OTA (over the air) Function Firmware and Wi-Fi® System Firmware updates via any web browser (not mobile browser) on a PC that is connected to Wi-Fi®. The update function for both types of updates can be found at the bottom of the Advanced Tab on the wireless settings interface (see Advanced Settings via Web Interface).

Follow the steps below to update your device's Function or Wi-Fi® System Firmware:

1. Download the latest version of the firmware (Function or Wi-Fi®) and save it to your PC. Remember where you saved the file.
2. Press and hold the WI-FI/SENSOR button for six (6) seconds to put the display console into AP mode, then connect the PC to the console (refer to steps in Setting Up Wi-Fi® Connection on page 14).
3. Click the button that says Browse next to the appropriate type of update that you downloaded and navigate to the location where you saved the file.
4. Click the corresponding Upload button to transfer the updated file to the console.
5. The file will install automatically once it is uploaded. You can view update progress on the display console in the wind direction section (the number displayed will correspond to the percentage completed, e.g. 50 = 50%).
6. The console will restart once the update completes.

**NOTES:** You cannot update the Function Firmware and Wi-Fi® Firmware at the same time. Updates must be installed one by one.

**Make sure the power cable remains connected during the update process.**

Make sure your PC's wireless connection is stable.

Once the update process starts, do not try to do anything else on your PC or on the display console.

During the firmware update process, the console will stop uploading data temporarily. It will reconnect to your router and resume uploading data once the update is complete. If the console cannot connect to your router, you may need to set up the Wi-Fi® connection again, following the steps on page 14.

Once your firmware update is complete, you may need to input your Weather Underground ID and password again on the SETUP tab of the wireless interface.

## ■ OPERATING INSTRUCTIONS

### OTHER CONSOLE SETTINGS AND FUNCTIONS

#### CLOCK

##### Manually Setting the Time

The display console is designed to synchronize with the internet time server to obtain the local time, but if you want to use it without connecting to your home wireless network, you can set the time manually. During initial setup, you will need to press and hold the WI-FI/SENSOR button for six (6) seconds, then let the display console return to normal mode. This will put it into offline mode for you to use it.

















1. In normal operating mode while offline, press and hold the CLOCK button for two (2) seconds to enter the clock setting menu.
2. Press the UP or DOWN buttons to adjust the time zone.
3. Press the CLOCK button again to make adjustments to the next setting.
4. Settings will cycle through the following options: > DST ON/OFF > Hour > Minute > 12/24-hour Format > Year > Month > Day > M-D/D-M Format > Time Sync ON/OFF > Language.
5. Press the CLOCK button one final time after adjusting all settings options to save and exit, or the console will automatically save and exit the menu after 60 seconds of idle time.

**NOTES:** In normal operating mode, press the CLOCK button once to switch between date and year display.

While adjusting settings, you can press and hold the CLOCK button for two (2) seconds to return to normal mode.

##### Moon Phase

The display console calculates the moon phase according to your time, date, and time zone. The table below explains the corresponding phases and their icons for both Northern and Southern hemispheres. Please refer to the section regarding Pointing the Wireless 5-in-1 Outdoor Sensor to South for more information on setting up your wireless weather sensor in the Southern Hemisphere.

Northern Hemisphere Icons	Moon Phase	Southern Hemisphere Icons
	New Moon	
	Waxing Crescent Moon	
	First Quarter Moon	
	Waxing Gibbous Moon	
	Full Moon	
	Waning Gibbous Moon	
	Third Quarter Moon	
	Waning Crescent Moon	

### Daylight Saving Time (DST)

The display console will come with the DST function set to "AUTO" (for EU and US version). Using the date on your console, the time will be automatically adjusted forward by 1 hour for the summer daylight saving period. This will be indicated by a DST icon shown on the LCD display.

### Setting the Alarm

To use your display console as an alarm clock, follow the instructions below:

1. In normal operating mode, press and hold the ALARM button for two (2) seconds until the alarm hour starts flashing. This indicates that you have entered the alarm time setting mode.
2. Use the UP or DOWN buttons to adjust the alarm hour. Press and hold either button to move through the hours quickly.
3. Press the ALARM button again to confirm the alarm hour and move to adjusting the minutes. The minute digits should be flashing.
4. Use the UP or DOWN buttons to adjust the alarm minute. Press and hold either button to move through the minutes quickly.
5. Press the ALARM button to save and exit the menu.

**NOTE:** Once you have an alarm set, the icon will be displayed next to the time on the LCD display. The alarm function will be activated automatically once you set a time.

### Activating/Deactivating the Alarm & Temperature Pre-Alarm

The temperature pre-alarm will alert you 30 minutes prior to your alarm time whenever the outdoor temperature falls below 26.5 °F (-3 °C).

1. In normal operating mode, press the ALARM button to display the set alarm time for five (5) seconds.
2. When the alarm time is being shown on the LCD display, press the ALARM button again to cycle through the alarm functions as shown below. The corresponding icons will appear on the LCD display.

		
<b>Alarm off</b>	<b>Alarm on</b>	<b>Alarm with ice-alert</b>



3. When the clock reaches the designated alarm time, the alarm sound will start playing.
4. To stop the alarm:
  - a. Allow the alarm to continue for two (2) minutes and it will stop itself automatically. It will remain set for the following day.
  - b. Press the SNOOZE button on top of the unit to snooze the alarm for five (5) minutes. The snooze can be set continuously for 24 hours. We don't recommend doing that, though. While the console is in snooze mode, the alarm icon will continue flashing.
  - c. Press and hold the SNOOZE button for two (2) seconds to stop the alarm completely. It will stay set for the following day.
  - d. Press the ALARM button to stop the alarm completely. It will remain set for the following day.

**NOTE:** The snooze could be used continuously for 24 hours. During the snooze, the alarm icon  will keep flashing.

## TEMPERATURE

### Temperature/Humidity & Trends

Press the °C/°F button to switch between Celsius and Fahrenheit temperature measurements. The arrows show the trend in changes to the temperature/humidity levels.

<b>Arrow Icon</b>			
<b>Temp/Humidity Trend</b>	<b>Rising</b>	<b>Steady</b>	<b>Falling</b>

**NOTES:** If/when the temperature outside falls below -40 °F (-40 °C), the LCD display will show the word "LO" in the temperature section. If the temperature outside rises above 176 °F (80 °C), the LCD display will show the word, "HI" in the temperature section.

If/when the humidity level falls below 1%, the LCD display will show the word "LO" in the humidity section. If/when the humidity level rises above 99%, the LCD display will show the word, "HI" in the humidity section.









### Viewing Outdoor Channels

This console is capable of pairing with the wireless weather sensor and up to seven (7) additional wireless hydro-thermo sensors. If you have two (2) or more sensors installed, press the CH button to cycle between different wireless channels in normal operating mode, or press and hold the CH button for two (2) seconds to toggle auto-cycle mode on, which cycles through displaying all connected channels at 4-second intervals. While the console is in auto-cycle mode, you can press the CH button once to toggle auto-cycle mode off and continue displaying the current channel.

### Receiving Wireless Sensor Signals

1. While in normal operating mode, press the WI-FI/SENSOR button once to start receiving the current sensor signal on the channel being displayed. (i.e. if you're on CH 1 and press the WI-FI/SENSOR button, the current wireless sensor signal being received will only display on CH 1.) The signal icon will start flashing.
2. The signal icon will continue flashing until it successfully receives a signal. If no signal is received within five (5) minutes, the icon will disappear.

<b>OUTDOOR 7-IN-1 SENSOR</b>			
<b>INDOOR CHANNEL SENSOR</b>			
	<b>No signal</b>	<b>Weak signal</b>	<b>Good signal</b>

3. If the signal for the outdoor channel has been interrupted and does not recover within 15 minutes, the signal icon will disappear. The temperature and humidity section (outdoor) will display “—” on the corresponding channel.
4. If the signal still does not recover within 48 hours, the “—” display will become permanent. You will need to replace the batteries on the associated channel's sensor and press the WI-FI/SENSOR button to pair up the sensors again.
5. After replacing batteries in the display console or the wireless weather sensor, or if the unit fails to receive a specified channel, press the WI-FI/SENSOR button while the failed channel is being displayed to manually receive that sensor's signal again.

### Indoor Comfort Indicator Key

The indoor comfort indicator displays a pictorial representation based on the indoor air temperature and humidity levels to determine the approximate comfort level.

		
<b>Too cold</b>	<b>Comfortable</b>	<b>Too hot</b>

**NOTE:** Comfort indicator levels may vary even when the temperature is the same due to variances in relative humidity levels. No comfort indicator will be displayed if the temperature falls below 32 °F (0 °C) or over 140 °F (60 °C).

## WIND

### Wind Callouts

Press the °C/°F button to switch between Celsius and Fahrenheit temperature measurements. The arrows show the trend in changes to the temperature/humidity levels.

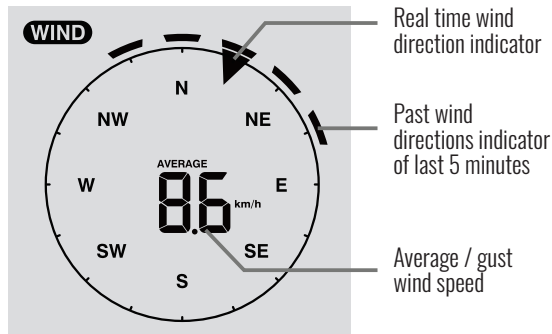

### Selecting Wind Display Mode

While in normal operating mode, press the WIND button to switch between the average wind speed measurement and gust wind speed measurement.

### Set Wind Speed Units

1. While in normal operating mode, press and hold the WIND button for two seconds to enter the wind speed unit setting mode. The unit display will start flashing. Press the ▲ or ▼ buttons to cycle through the wind speed units in the following order: **mph > m/s > km/h > knots**
2. Press the WIND button again to return to normal display mode.
3. Press the WIND button while in normal operating mode to switch between AVERAGE and GUST wind speeds.

### Beaufort Scale Chart

While in normal operating mode, press the WIND button to switch between the average wind speed measurement and gust wind speed measurement.

Beaufort Scale	Description	Wind Speed	Land Condition
0	Calm	< 1 km/h	Calm. Smoke rises vertically.
		< 1 mph	
		< 1 knots	
		< 0.3 m/s	
1	Light air	1.1 - 5km/h	Smoke drift indicates wind direction. Leaves and wind vanes are stationary.
		1 - 3 mph	
		1 - 3 knots	
		0.3 - 1.5 m/s	
2	Light breeze	6 - 11 km/h	Wind felt on exposed skin. Leaves rustle. Wind vanes begin to move.
		4 - 7 mph	
		4 - 6 knots	
		1.6 - 3.3 m/s	
3	Gentle breeze	12 - 19 km/h	Leaves and small twigs constantly moving. Light flags extended.
		8 - 12 mph	
		7 - 10 knots	
		3.4 - 5.4 m/s	
4	Moderate breeze	20 - 28 km/h	Dust and loose paper raised. Small branches begin to move.
		13 - 17 mph	
		11 - 16 knots	
		5.5 - 7.9 m/s	
5	Fresh breeze	29 - 38 km/h	Branches of a moderate size move. Small trees in leaf begin to sway.
		18 - 24 mph	
		17 - 21 knots	
		8.0 - 10.7 m/s	
6	Strong breeze	39 - 49 km/h	Large branches in motion. Whistling heard in overhead wires. Umbrella use becomes difficult. Empty plastic bins tip over.
		25 - 30 mph	
		22 - 27 knots	
		10.8 - 13.8 m/s	
7	High wind	50 - 61 km/h	Whole trees in motion. Effort needed to walk against the wind.
		31 - 38 mph	
		28 - 33 knots	
		13.9 - 17.1 m/s	
8	Gale	62 - 74 km/h	Some twigs broken from trees. Cars veer on road. Progress on foot is seriously impeded
		39 - 46 mph	
		34 - 40 knots	
		17.2 - 20.7 m/s	
9	Strong gale	75 - 88 km/h	Some branches break off trees, and some small trees blow over. Construction / temporary signs and barricades blow over.
		47 - 54 mph	
		41 - 47 knots	
		20.8 - 24.4 m/s	
10	Storm	89 - 102 km/h	Trees are broken off or uprooted, structural damage likely.
		55 - 63 mph	
		48 - 55 knots	
		24.5 - 28.4 m/s	
11	Violent storm	103 - 117 km/h	Widespread vegetation and structural damage likely.
		64 - 73 mph	
		56 - 63 knots	
		28.5 - 32.6 m/s	
12	Hurricane force	≥ 118 km/h	Severe widespread damage to vegetation and structures. Debris and unsecured objects are hurled about.
		≥ 74 mph	
		≥ 64 knots	
		≥ 32.7 m/s	

# WEATHER

## Weather Indexes

When reading the Weather Index display, you can press the INDEX button to cycle through different weather indexes in the following order: **Feels Like > Dew Point > Heat Index > Wind Chill**

### Feels Like

The Feels Like temperature index determines what temperature it actually feels like outside, taking into account factors like wind chill and the heat index.

### Wind Chill

Wind Chill is determined by a combination of the wireless weather sensor's temperature and wind speed data.

### Heat Index

The Heat Index is determined by the wireless weather sensor's temperature and humidity readings when the temperature outdoors is between 80 °F (27 °C) and 120 °F (50 °C).







Heat Index range	Warning	Explanation
80 °F to 90 °F (27 °C to 32 °C)	Caution	Possibility of heat exhaustion
91 °F to 105 °F (33 °C to 40 °C)	Extreme Caution	Possibility of dehydration
106 °F to 129 °F (41 °C to 54 °C)	Danger	Heat exhaustion likely
≥ 130 °F (≥ 55 °C)	Extreme Danger	Strong risk of dehydration / sun stroke

### Dew Point

- The Dew Point is the temperature below which the water vapor in air at constant barometric pressure condenses into liquid water at the same rate at which it evaporates. The condensed water is called dew when it forms on a solid surface.
- The Dew Point temperature is determined by the temperature and humidity data from the wireless weather sensor.

### Weather Forecast

The built-in barometer can detect atmospheric pressure changes and, based on the data collected, predict weather conditions in the forthcoming 12-24 hours within a 19 - 31 mile (30 - 50 km) radius.

					
Sunny	Partly cloudy	Cloudy	Rainy	Rainy / Stormy	Snowy

NOTES: The accuracy of a general pressure-based forecast is about 70% - 75%. Forecasts are not guaranteed.

The forecast section reflects a general prediction for the next roughly 12 ~ 24 hours.

It may not necessarily reflect the current situation.

The SNOWY weather forecast is not based on the atmospheric pressure, but based on the current temperature reading from that wireless sensor. When the outdoor temperature is below 26 °F (-3 °C), the SNOWY weather indicator will be shown on the LCD display.

## PRESSURE

### Barometric Pressure

The atmospheric pressure is the pressure at any location on Earth caused by the weight of the column of air directly above that location. The average pressure gradually decreases as the altitude increases. Meteorologists use barometers to measure atmospheric pressure. Since variation in atmospheric pressure can be greatly affected by the weather, it is possible to forecast the weather by measuring these changes in pressure.

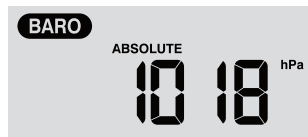

### Set Barometer Units

1. In normal operating mode, press the BARO button to cycle through options for the barometer units of measure in the following order: **hPa** > **inHg** > **mmHg**.
2. While in normal operating mode, press and hold the BARO button to switch between ABSOLUTE and RELATIVE barometric pressure displays.

<b>Absolute</b>	The absolute atmospheric pressure of your location
<b>Relative</b>	The relative atmospheric pressure based on the sea level

## RAIN

### Rainfall

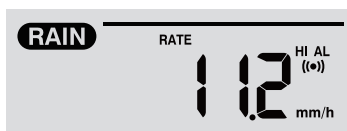

The Rainfall shows information regarding the rainfall and rain rate.

### Set the Rainfall Units

1. Press and hold the RAIN button for two (2) seconds to enter unit setting mode.
2. Press the ▲ or ▼ buttons to toggle the units of measure for rainfall between mm and in.
3. Press the RAIN button again to save and exit the setting mode.

### Select the Rainfall Display Mode

Press the RAIN button to toggle between:

1. HOURLY: total rainfall in the past hour
2. DAILY: total rainfall since midnight
3. WEEKLY: total rainfall for the current week
4. MONTHLY: total rainfall since the beginning of the current month
5. RATE: current rainfall rate in the past hour (updates every 24 seconds)
6. ACCUMULATION: total rainfall since the last reset (will show the record start date on the display for five (5) seconds)

### Reset the Total Rainfall Record

While in normal operating mode, press and hold the °C/°F button for two (2) seconds to reset the ACCUMULATION rainfall record.

**NOTE: To ensure precise data, please reset the ACCUMULATION rainfall record whenever you move and reinstall your wireless weather sensor to a different location.**

## MAX/MIN

### MAX/MIN DATA RECORD

The display console can record the accumulated and daily MAX/MIN weather data with a corresponding time stamp for you to review.

## View the Accumulated MAX/MIN

While in normal operating mode, press the MAX/MIN button to cycle through the daily MAX/MIN records. Records are displayed in the following order:

Outdoor MAX temperature > outdoor MIN temperature > outdoor MAX humidity > outdoor MIN humidity > indoor\* MAX temperature > indoor\* MIN temperature > indoor\* MAX humidity > indoor\* MIN humidity > MAX average wind speed > MAX gust > MAX feels like temperature > MIN feels like temperature > MAX dew point > MIN dew point > MAX heat index > MIN heat index > MAX wind chill > MIN wind chill > MAX UV index > MAX light intensity > MAX relative pressure > MIN relative pressure > MAX absolute pressure > MIN absolute pressure > MAX rain rate

\* Or current display channel sensor

## Reset the Total MAX/MIN Records

Press and hold the MAX/MIN button for two (2) seconds to reset the MAX/MIN records of the specific weather display section.

## HISTORY

### History Data for Past 24 Hours

The display console automatically stores the weather data from the past 24 hours.

1. Press the HISTORY button to check the beginning of the current hour's weather data, e.g., if the current time is 7:25 AM on Dec 1st, the display will show the data for 7:00 AM on Dec 1st.
2. Press the HISTORY button to view the older readings for each hour of the past 24 hours, e.g. 6:00 AM (Dec 1st), 5:00 AM (Dec 1st), ..., 9:00 AM (Nov 30th), 8:00 AM (Nov 30th).

**NOTE:** The LCD display will also show the History icon, along with the time and date, when displaying the history data records.

## WEATHER ALERT SETTINGS

The Weather Alert can alert you to certain weather conditions by activating an alarm sound and flashing the LCD display's alert icon when specific criteria are met.

### Set the Alert

1. Press the ALERT button to cycle through and display the desired weather alert options in the following order:

Alert reading Sequence	Setting Range	Display Section	Default
Outdoor Temperature High Alert	-40°C ~ 80°C	Outdoor temperature & humidity	40°C
Outdoor Temperature Low Alert			0°C
Outdoor Humidity High Alert	1% ~ 99%		80%
Outdoor Humidity Low Alert			40%
Indoor Current Channel Temperature High Alert	-40°C ~ 80°C	Indoor CH temperature & humidity	40°C
Indoor Current Channel Temperature Low Alert			0°C
Indoor Current Channel Humidity High Alert	1% ~ 99%		80%
Indoor Current Channel Humidity Low Alert			40%
Average Wind Speed	0.1m/s ~ 50m/s	Wind direction & speed	17.2m/s
Feels Like High Alert	-65°C ~ 50°C	Weather index	20°C
Feels Like Low Alert			0°C
Dewpoint High Alert	-40°C ~ 80°C		10°C
Dewpoint Low Alert			-10°C
Heat Index High Alert	26°C ~ 50°C		30°C
WindChill Low Alert	-65°C ~ 18°C		0°C
UV index High Alert	1 ~ 16	UV & light intensity	10
Light intensity High Alert	0.01 ~ 200.0Klux		100Klux
Pressure Drop	1hPa ~ 10hPa	Barometer	3hPa
Hourly Rainfall	1mm ~ 1000mm	Rainfall	100mm

- When on the alert option you want to set, press and hold the ALERT button for two (2) seconds to enter that alert's settings mode. The alert option will start flashing.
- Press the ▲ or ▼ buttons to adjust the value, or press and hold the buttons to adjust the value more quickly.
- Press the ALERT button when the desired value is reached to save the alert setting, then press the ALARM button to toggle the weather alert on or off.

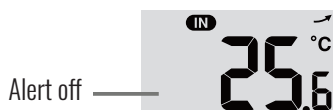
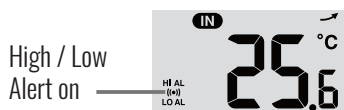

- Press any button on the front of the display console to save and return to normal mode, or wait 30 seconds without pressing any buttons and the alert will save itself and return to normal mode.



## Silence the Weather Alert Alarm

Press the SNOOZE/LIGHT button on top of the display console to silence the alarm, or it will automatically turn off after two (2) minutes.

**NOTES:** Once the alert is triggered, the alarm will sound for two (2) minutes and the associated alert icon and weather readings will flash.

If the alert alarm automatically shuts off after two (2) minutes instead of being manually shut off, the associated alert icon and readings will continue flashing until the reading is out of the alert range. The weather alert alarm will go off once the readings fall into alert range again.

## CARE AND MAINTENANCE

### BATTERY REPLACEMENT

If the low battery indicator icon is displayed in the outdoor temperature and humidity section or the corresponding CH section of the LCD console display, this indicates that the batteries in your wireless weather sensor(s) are running low and should be replaced. Make sure to replace all batteries at the same time.

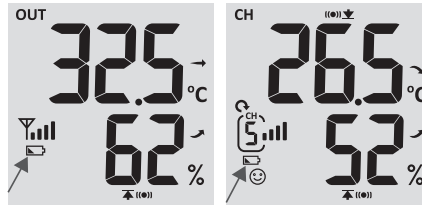

**NOTE:** The battery life of the outdoor weather sensor lasts about two (2) years and will run even longer with the built-in solar panel.

### CLEANING THE RAIN COLLECTOR

1. Unscrew the funnel lid to the unlock position.

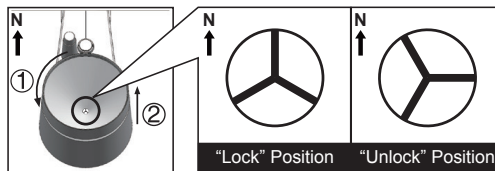

2. Gently remove the funnel lid of the rain collector.
3. Clean and remove any debris or insects in the funnel.
4. Once all parts are fully dry, reinstall them and return the funnel lid on the rain collector to a locked position.

### CLEANING THE HYGRO-THERMO SENSOR

1. Unscrew the two (2) screws at the bottom of the sensor casing.
2. Gently pull out the shield.
3. Carefully remove any dirt or insects inside the sensor casing, making sure the inside sensors remain dry.
4. Clean the shield with water and remove any dirt or insects.
5. Once the parts are fully clean and dry, reinstall them and replace the screws.

## ■ TROUBLESHOOTING GUIDE

Issues	Solutions
5-in-1 wireless sensor is not connecting	<ul style="list-style-type: none"> <li>• Make sure the sensor is within the specified transmission range.</li> <li>• Reset the sensor and sync it again to the display console.</li> </ul>
Indoor wireless sensor is not connecting	<ul style="list-style-type: none"> <li>• Make sure the sensor is within the transmission range.</li> <li>• Make sure the channel displayed matches the channel selection on the sensor.</li> <li>• Reset the sensor and sync it again to the display console.</li> </ul>
The device is not connecting to Wi-Fi®	<ul style="list-style-type: none"> <li>• Check for the Wi-Fi® symbol on the display console.</li> <li>• Make sure you are attempting to connect to the 2.4 GHz network and not the 5 GHz network.</li> </ul>
Data is not reporting to Wunderground.com or Weathercloud.net	<ul style="list-style-type: none"> <li>• Ensure your Station ID and Station Key are correct.</li> <li>• Make sure that the date and time parameters of your search are correct.</li> <li>• Ensure your time zone is properly set.</li> </ul>
Wunderground rainfall total is offset by 1 hour during daylight saving time	<ul style="list-style-type: none"> <li>• Ensure that the time zone of the device is set correctly on Wunderground.</li> <li>• Ensure that the time zone and DST settings on your console are correct.</li> <li>• If your station is located outside of the US, turn off the DST function on your display console.</li> </ul>
Rainfall totals are not correct	<ul style="list-style-type: none"> <li>• Make sure the rain collector is clean so the tipping bucket inside can work smoothly.</li> </ul>
Temperature readings are too high during the day	<ul style="list-style-type: none"> <li>• Make sure the sensor is in an open area and is at least 6.6 ft. (2 m) off the ground.</li> <li>• Make sure the sensor is not too close to heat generating sources like buildings, pavement, walls, or air conditioning units.</li> </ul>

## ■ SPECIFICATIONS

<b>DISPLAY CONSOLE</b>	
<b>General Specifications</b>	
Dimensions (W x H x D without stand)	4.6" x 7.6" x 0.8" (118 x 192.5 x 21 mm)
Weight	265 g (with batteries)
Main power	DC 5V, 1A adapter (Manufacturer: HUAXU Electronics Factory, Model: HX075-0501000-AB, HX075-0501000-AG-001 or HX075-050100-AX)
Backup battery	CR2032
Operating temperature range	23 °F ~ 122 °F (-5 °C ~ 50 °C)
Operating humidity range	10 ~ 90% RH
<b>Wi-Fi® Communication Specifications</b>	
Standard	802.11 b/g/n
Operating frequency	2.4 GHz
Supported router security type	WPA / WPA2 OPEN, WEP (WEP will only support a hexadecimal password)
Supported devices for setup UI	Smart devices, tablets, laptops, or PCs with built-in Wi-Fi® and AP mode functionality such as: Android™ phone or tablet, iPhone or iPad, or a Windows® laptop/PC
Recommended web browser for setup UI	Latest version of any web browser that supports HTML 5
<b>Wireless Sensor Communication Specifications</b>	
Supported sensors	One (1) Wireless 5-in-1 weather outdoor sensor and up to seven (7) optional wireless hygro-thermo indoor sensors
RF frequency	915 MHz
RF transmission range	492 ft (150 m)
<b>Time Related Function Specifications</b>	
Time display	HH: MM
Hour format	12 hour or 24 hour
Date display	DD / MM or MM / DD
Time synchronization method	Synchronizes with UTC clock through internet time server
Weekday languages	EN / DE / FR / ES / IT / NL / RU
Time zones	GMT +13 ~ GMT -12
DST	AUTO / OFF
<b>Barometer Display &amp; Function Specifications</b>	
<b>Note:</b> The following details are listed as they are displayed or operate on the console.	
Barometer units	hPa, inHg, and mmHg
Measuring range	540 ~ 1100 hPa (relative setting range 930 ~ 1050 hPa)
Accuracy	(700 ~ 1100 hPa ± 5 hPa) / (540 ~ 696 hPa ± 8 hPa) (20.67 ~ 32.48 inHg ± 0.15 inHg) / (15.95 ~ 20.55 inHg ± 0.24 inHg) (525 ~ 825 mmHg ± 3.8 mmHg) / (405 ~ 522 mmHg ± 6 mmHg) Typical at 77°F (25°C)
Resolution	1 hPa / 0.01 inHg / 0.1 mmHg
Weather forecast	Sunny / Clear, Slightly Cloudy, Cloudy, Rainy, Rainy / Stormy, and Snowy
Memory modes	Historical data of past 24 hours, daily Max/Min

<b>Indoor / Outdoor Temperature Display &amp; Function Specifications</b>	
<b>Note:</b> The following details are listed as they are displayed or operate on the console.	
Temperature unit	°C and °F
Indoor accuracy	< 0 °C or > 40 °C ± 2 °C (< 32 °F or > 104 °F ± 3.6 °F)
Outdoor accuracy	41.1 °F ~ 140 °F ± 0.7 °F (5.1 °C ~ 60 °C ± 0.4 °C) -3.8 °F ~ 41 °F ± 1.8 °F (-19.9 °C ~ 5 °C ± 1 °C) -40 °F ~ -3.7 °F ± 2.7 °F (-40 °C ~ -20 °C ± 1.6 °C)
Resolution	0.1 °F / 0.1 °C
Memory modes	Historical data of past 24 hours, daily Max/Min
<b>Indoor / Outdoor Humidity Display &amp; Function Specifications</b>	
<b>Note:</b> The following details are listed as they are displayed or operate on the console.	
Humidity unit	%
In/Out accuracy:	1 ~ 20% RH ± 6.5% RH @ 77 °F (25 °C) 21 ~ 80% RH ± 3.5% RH @ 77 °F (25 °C) 81 ~ 99% RH ± 6.5% RH @ 77 °F (25 °C)
Resolution	1%
Memory modes	Historical data of past 24 hours, daily Max/Min
Alarm	High / Low Humidity Alert
<b>Wind Speed &amp; Direction Display and Function Specifications</b>	
<b>Note:</b> The following details are listed as they are displayed or operate on the console.	
Wind speed unit	mph, m/s, km/h, and knots
Wind speed display range	0 ~ 112 mph, 50 m/s, 180 km/h, 97 knots
Resolution	0.1 mph, 0.1 m/s, 0.1 km/h, 0.1 knots
Speed accuracy	< 5 m/s: ± 0.5 m/s; > 5 m/s: ± 6% (whichever is greater)
Display mode	Gust / Average
Memory modes	Historical data of past 24 hours, daily Max/Min
Wind direction display mode	16 directions or 360 degree
<b>Rain Display &amp; Function Specifications</b>	
<b>Note:</b> The following details are listed as they are displayed or operate on the console.	
Unit for rainfall	mm and in
Unit for rain rate	in/h or mm/h
Accuracy for rainfall	± 7%
Range of rainfall	0 ~ 787.3 in (0 ~ 19999 mm)
Resolution	0.01 in (0.254 mm)
Display modes	Current
Memory modes	Historical Data of past 24 hours, daily Max
Rainfall display mode	Rate / Hourly / Daily / Weekly / Monthly / Total rainfall
<b>Weather Index Display &amp; Function Specifications</b>	
<b>Note:</b> The following details are listed as they are displayed or operate on the console	
Weather index mode	Feels like, wind chill, heat index, and dew point
Feels like display range	-85 °F ~ 122 °F (-65 °C ~ 50 °C)
Dew point display range	-4 °F ~ 176 °F (-20 °C ~ 80 °C)
Heat index display range	78.8 °F ~ 122 °F (26 °C ~ 50 °C)
Wind chill display range	-85 °F ~ 64.4 °F (-65 °C ~ 18 °C) (wind speed > 4.8 km/h)
Memory modes	Historical Data of past 24 hours, Daily Max/Min

<b>Wireless 5-in-1 Outdoor Sensor Specifications</b>	
Dimensions (W x H x D)	12.7" x 11.7" x 8.5" (322 x 296 x 217 mm)
Weight	1.5 lb. (674 g) (with batteries)
Main power	3 x AA 1.5 V batteries (lithium batteries recommended)
Weather data	Temperature, humidity, wind speed, wind direction, rainfall
RF transmission range	492 ft (150 m)
RF frequency	915 Mhz
Transmission interval	<ul style="list-style-type: none"> <li>• 12 seconds for wind speed and wind direction data</li> <li>• 24 seconds for temperature, humidity, and rain data</li> </ul>
Operating temperature range	-40 °F - 140 °F (-40 ~ 60 °C)
Operating humidity range	1 ~ 99% RH

## LIMITED WARRANTY TO ORIGINAL CONSUMER

This Logia™ 5-in-1 Wireless Weather Station with Wi-Fi® and Solar Panel (“Product”), including any accessories included in the original packaging, as supplied and distributed new by an authorized retailer is warranted by C&A Marketing, Inc. (the “Company”) to the original consumer purchaser only, against certain defects in material and workmanship (“Warranty”) as follows:

To receive Warranty service, the original consumer purchaser must contact the Company or its authorized service provider for problem determination and service procedures. Proof of purchase in the form of a bill of sale or receipted invoice, evidencing that the Product is within the applicable Warranty period(s), MUST be presented to the Company or its authorized service provider in order to obtain the requested service.

Service options, parts availability, and response times may vary and may change at any time. In accordance with applicable law, the Company may require that you furnish additional documents and/or comply with registration requirements before receiving warranty service. Please contact our customer service for details on obtaining warranty service:

**Email: [info@supportcbp.com](mailto:info@supportcbp.com)**

**Phone: 833-815-0568**

Shipping expenses to the Company’s Return Facility are not covered by this warranty, and must be paid by the consumer. The consumer likewise bears all risk of loss or further damage to the Product until delivery to said facility.

**EXCLUSIONS AND LIMITATIONS** The Company warrants the Product against defects in materials and workmanship under normal use for a period of **ONE (1) YEAR** from the date of retail purchase by the original end-user purchaser (“Warranty Period”). If a hardware defect arises and a valid claim is received within the Warranty Period, the Company, at its sole option and to the extent permitted by law, will either (1) repair the Product defect at no charge, using new or refurbished replacement parts, (2) exchange the Product with a Product that is new or which has been manufactured from new or serviceable used parts and is at least functionally equivalent to the original device, or (3) refund the purchase price of the Product.

A replacement Product or part thereof shall enjoy the warranty of the original Product for the remainder of the Warranty Period, or ninety (90) days from the date of replacement or repair, whichever provides you longer protection. When a Product or part is exchanged, any replacement item becomes your property, while the replaced item becomes the Company’s property. Refunds can only be given if the original Product is returned.

This Warranty does not apply to:

- (a) Any non-Logia™ 5-in-1 Wireless Weather Station with Wi-Fi® and Solar Panel product, hardware or software, even if packaged or sold with the Product;
- (b) Damage caused by use with non-Logia™ 5-in-1 Wireless Weather Station with Wi-Fi® and Solar Panel products;
- (c) Damage caused by accident, abuse, misuse, flood, fire, earthquake, or other external causes;
- (d) Damage caused by operating the Product outside the permitted or intended uses described by the Company;
- (e) Damage caused by third party services;
- (f) A Product or part that has been modified to alter functionality or capability without the written permission of the Company;
- (g) Consumable parts, such as batteries, fuses, and bulbs;
- (h) Cosmetic damage; or
- (i) If any Logia™ 5-in-1 Wireless Weather Station with Wi-Fi® and Solar Panel serial number has been removed or defaced.

This Warranty is valid only in the country where the consumer purchased the Product, and only applies to Products purchased and serviced in that country.

The Company does not warrant that the operation of the Product will be uninterrupted or error-free. The Company is not responsible for damage arising from your failure to follow instructions relating to its use.

**NOTWITHSTANDING ANYTHING TO THE CONTRARY AND TO THE MAXIMUM EXTENT PERMITTED BY APPLICABLE LAW, THE COMPANY PROVIDES THE PRODUCT “AS-IS” AND “AS-AVAILABLE” FOR YOUR CONVENIENCE AND THE COMPANY AND ITS LICENSORS AND SUPPLIERS EXPRESSLY DISCLAIM ALL WARRANTIES AND CONDITIONS, WHETHER EXPRESSED, IMPLIED, OR STATUTORY, INCLUDING THE WARRANTIES OF MERCHANTABILITY, FITNESS FOR A PARTICULAR PURPOSE, TITLE, QUIET ENJOYMENT, ACCURACY, AND NON-INFRINGEMENT OF THIRD-PARTY RIGHTS. THE COMPANY DOES NOT GUARANTEE ANY SPECIFIC RESULTS FROM THE USE OF THE PRODUCT, OR THAT THE COMPANY WILL CONTINUE TO OFFER OR MAKE AVAILABLE THE PRODUCT FOR ANY PARTICULAR LENGTH OF TIME. THE COMPANY FURTHER DISCLAIMS ALL WARRANTIES AFTER THE EXPRESS WARRANTY PERIOD STATED ABOVE.**

**YOU USE THE PRODUCT AT YOUR OWN DISCRETION AND RISK. YOU WILL BE SOLELY RESPONSIBLE FOR (AND THE COMPANY DISCLAIMS) ANY AND ALL LOSS, LIABILITY, OR DAMAGES RESULTING FROM YOUR USE OF THE PRODUCT.**

**NO ADVICE OR INFORMATION, WHETHER ORAL OR WRITTEN, OBTAINED BY YOU FROM THE COMPANY OR THROUGH ITS AUTHORIZED SERVICE PROVIDERS SHALL CREATE ANY WARRANTY.**

**IN NO EVENT WILL THE COMPANY’S TOTAL CUMULATIVE LIABILITY ARISING FROM OR RELATED TO THE PRODUCT, WHETHER IN CONTRACT OR TORT OR OTHERWISE EXCEED THE FEES ACTUALLY PAID BY YOU TO THE COMPANY OR ANY OF ITS AUTHORIZED RESELLERS FOR THE PRODUCT AT ISSUE IN THE LAST YEAR FROM YOUR PURCHASE. THIS LIMITATION IS CUMULATIVE AND WILL NOT BE INCREASED BY THE EXISTENCE OF MORE THAN ONE INCIDENT OR CLAIM. THE COMPANY DISCLAIMS ALL LIABILITY OF ANY KIND OF ITS LICENSORS AND SUPPLIERS. IN NO EVENT WILL THE COMPANY OR ITS LICENSORS, MANUFACTURERS, AND SUPPLIERS BE LIABLE FOR ANY INCIDENTAL, DIRECT, INDIRECT, SPECIAL, PUNITIVE, OR CONSEQUENTIAL DAMAGES (SUCH AS, BUT NOT LIMITED TO, DAMAGES FOR LOSS OF PROFITS, BUSINESS, SAVINGS, DATA, OR RECORDS) CAUSED BY THE USE, MISUSE, OR INABILITY TO USE THE PRODUCT.**

Nothing in these terms shall attempt to exclude liability that cannot be excluded under applicable law. Some countries, states, or provinces do not allow the exclusion or limitation of incidental or consequential damages or allow limitations on warranties, so certain limitations or exclusions may not apply to you. This warranty gives you specific legal rights, and you may have other rights that vary from state to state or province to province. Contact your authorized retailer to determine if another warranty applies.

---

#### **FCC STATEMENT**

This device complies with Part 15 of the FCC Rules. Operation is subject to the following two conditions:

(1) This device may not cause harmful interference, and;

(2) This device must accept any interference received, including interference that may cause undesired operation.

NOTE: This equipment has been tested and found to comply with the limits for a Class B digital device, pursuant to part 15 of the FCC Rules. These limits are designed to provide reasonable protection against harmful interference in a residential installation. This equipment generates—and can radiate—radio frequency energy and, if not installed and used in accordance with the instructions, may cause harmful interference to radio communications. However, there is no guarantee that interference will not occur in a particular installation. If the equipment does not cause harmful interference to radio or television reception, which can be determined by turning the equipment off and on, the user is encouraged to try to correct the interference by one or more of the following measures:

- Reorient or relocate the receiving antenna
- Increase the separation between the equipment and the receiver
- Connect the equipment into an outlet on a circuit different from that to which the receiver is connected.
- Consult the dealer or an experienced radio/TV technician for help.

The provided shielded USB cable must be used with this unit to ensure compliance with the class B FCC limits.

**Warning: Changes or modifications to this unit not expressly approved by the party responsible for compliance could void the user’s authority to operate the equipment.**

---

If you experience any issues with your Logia™ 5-in-1 Wireless Weather Station with Wi-Fi® and Solar Panel, please contact us before returning your product to the place of purchase. We’re here to help!

#### **QUESTIONS OR PROBLEMS? CONTACT US!**

Email: [info@supportcbp.com](mailto:info@supportcbp.com) or call: 1-833-815-0568

[www.logiaweatherstation.com](http://www.logiaweatherstation.com)



LOGIA is a trademark of C&A IP Holdings, LLC, in the U.S.

Android is a trademark of Google LLC. Apple and App Store are trademarks of Apple Inc. in the U.S. and other countries. IOS is a trademark of Cisco in the U.S. and other countries and is used under license. Microsoft, Windows, Windows Server, Windows Vista, and Windows 10 are trademarks of Microsoft Corporation in the U.S. and/or other countries. Wi-Fi, WPA, and WPA2 are trademarks of Wi-Fi Alliance in the U.S. and/or other countries.

All other products, brand names, company names, and logos are trademarks of their respective owners, used merely to identify their respective products, and are not meant to connote any sponsorship, endorsement, or approval.

Distributed by C&A Marketing, Inc., 114 Tived Lane East, Edison, NJ 08837.

Made in China.

© 2020 C&A IP Holdings, LLC. All Rights Reserved.