

# CineVision Pro Fixed Frame Projector Screen Installation Guide

USER MANUAL



# Content

|                                    |    |
|------------------------------------|----|
| To Users                           | 2  |
| Safety Instructions                | 2  |
| Packing Contact                    | 4  |
| Matters Needing Attention          | 6  |
| Screen and projector compatibility | 7  |
| Operation Guide                    | 10 |
| Installation Steps                 | 11 |
| Screen Maintenance                 | 21 |
| Manufacturer's Warranty            | 22 |
| Certificate                        | 24 |
| Product Warranty Card              | 24 |

## To Users

Thank you for choosing the VIVIDSTORM projection screen.

Please read this manual carefully before using the product and keep it properly.

The manual of products, accessories, user interface, etc. in this description are schematic diagrams and are for reference only. Due to product updates, the actual product may be slightly different from the schematic diagram, please refer to the actual product.

## Safety Instructions

For your security and interest, to ensure safe and correct use of this product, always comply with the following precautions to avoid dangerous situations and damage to your unit:

### Safety Instructions



#### Shipping Instructions

Please use this product's original packaging or same materials to transport this product.



This symbol reminds the user to some important information related to operation and maintenance.

Please read this information carefully to avoid incorrect operation.



This symbol reminds users do not touch the screen with hands directly.



Do not place the equipment near fireplaces or high temperature objects such as gas stoves, barbecue or heaters;



Keep children and pet away from the product.



### Instructions for safe operation

- Never place the screen in an unstable location, bracket, wall, to prevent the product from falling, causing serious equipment damage and personal injury.
- Do not place this product upright as it may tip over and cause damage.
- Make sure the product protected from rain and moisture.
- Do not immerse or expose this product to water or other liquids.
- Do not place this product in the following environments:
  - Poor ventilation or narrow spaces.
  - Extremely hot, cold or humid environment.
- Do not place flammable objects near this product to avoid fire.

# Packing Contact

When opening the box, check the contents of the box the list below. If there is any omission, please contact the dealer in time.



Screen material



Inner frame × 4 (left and right short, top and bottom long)



Outer frame × 4 (short left and right, long up and down)



Corner protection × 4



Steel wire rod × 4 (short left and right, long up and down)



Support rod × 1 (non-standard configuration)



Wall mount × 2



L-shaped corner × 4 (outer frame)



Fixed self-adhesive iron sheet at the lower end × 2



Allen wrench × 2



Spring hook × 2 / extension spring (several)



L-shaped corner × 4 (inner frame)



Screws/washers (several)



Expansion screws (several)



White gloves × 1

## ⚠ Notice:

- Parking contact will be different for different countries (regions), Please refer to the actual item.
- Please keep the original packaging for future shipments.
- In special cases, the be taken out before transported. (Please contact the seller to inquire about the situation)

Because the installation method of ultra-short throw laser projector (laser TV) is divided into hoisting or placing on the desktop, the special anti-light direction structure of the screen material surface will be changed due to the installation method of the projector;

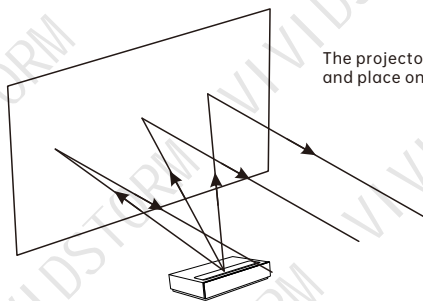

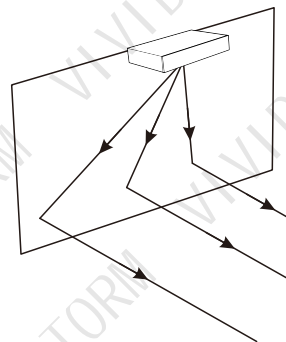

The projector is below the screen and place on the table or floor;



The projector is installed ceiling mounted (suspended installed);  
Rotate the screen material, Because the screen material itself has a sawtooth structure, it is divided into two structures; the upper slope is to resist and absorb the light, and the lower slope fully reflects the projector light; so we need to rotate the screen material so that the wiper can perfectly match the light of the projector, (the screen surface is resistant to light in the area below the screen, not against the ceiling light);

## Matters Needing Attention

-  Warning! If you do not strictly follow the prescribed precautions during use, this may lead to equipment damage and other unnecessary damage.
-  Please observe the family fire safety regulations; do not place the equipment near the fireplace or high temperature objects such as gas stove, barbecue or heater to avoid equipment damage.
-  Please keep this product out of the reach of children.

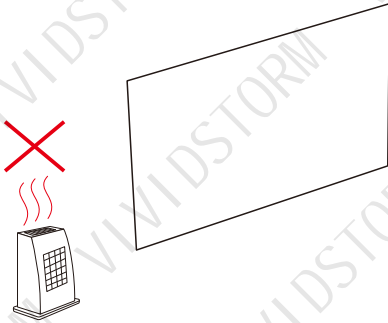

Do not place the equipment near the fireplace or high temperature objects such as gas stove, barbecue or heater



Keep children away from the product

## Screen and projector compatibility

Please note that the screen of this product is only suitable for use with Ultra short throw laser projector. If it is used with other projector, the effect of picture will be greatly reduced.

It is suggested that the ultra short focus laser projector throw ratio should be  $\leq 0.4$ . (please consult the projection manufacturer for specific parameters)

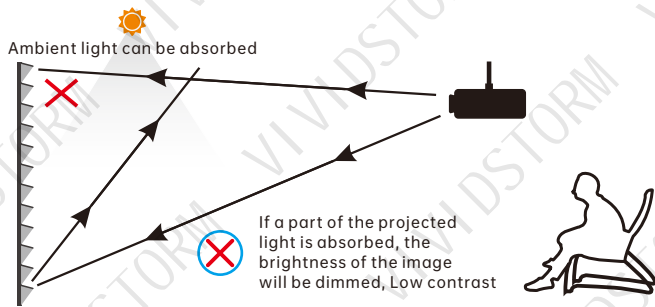
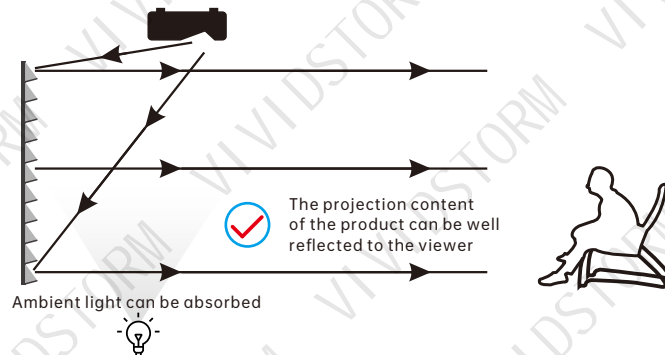
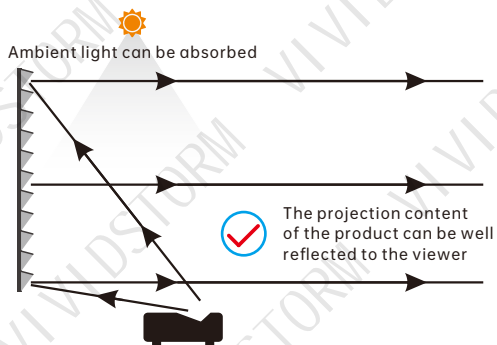

In view of the particularity of the screen structure of the product, projectors other than ultra short focus laser projectors are not compatible with this Screen fabric. If other projectors are used, the projection light may be absorbed or blocked by the Screen fabric.



3. When there are a few black spots, white spots, stains and other impurities on the screen surface, but if they are qualified according to the detection method, then such situation is not a product quality problem, and it is within the scope of product qualification.

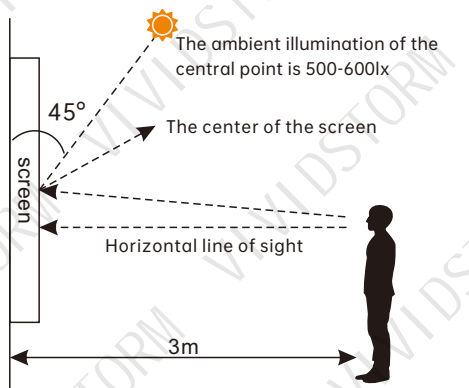

Figure 1 side view

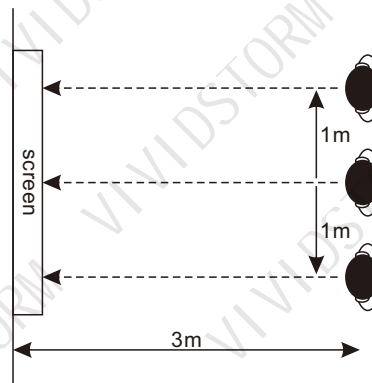

Figure 2 top view

The detection method is as follows:

- (1). Please open the screen of this product and close to the wall, and the observer can observe the film at a distance of 3 meters away from the screen;
- (2). The observer needs to observe the shadow in the normal light environment (illumination 500-600lx);
- (3). The distance between the observer and the front of the screen should be kept at a distance of 3 meters, and the center point of the screen should be close to or higher than the horizontal line of sight (as shown in Figure 1), and the observation should be made at the center point, 1 m to the left and 1 m to the right (as shown in Fig. 2).

Summary the test results of the product are within the allowable range, the product is qualified.



For the black spot defect which can be measured in appearance, if it can not be found by visual inspection, the product is normal.



For the appearance of specific measurable white spot defects, if visual inspection can not be found, then the product is normal.



If the visible dirt is within the allowable range of defects, the product is normal.



For the faint linear printing trace, if within the allowable range of defects, the product is normal.



For the inks caused by uneven printing traces, if within the allowable range of defects, the product is normal.

4. (1).The white screen is listed as the quality standard because it is not only the reflection surface of the projector image (the black surface is observed from the upper and lower direction, and the white surface is observed from the bottom direction), but also the main function surface of the viewing image, so the white screen is listed as the quality standard. It should be noted that if the white screen surface does not exceed the quality specification, it will be regarded as meeting the factory qualification standard.

(2).Different from the white screen, the black screen is used as a functional surface to absorb indoor ambient light. In view of the fact that there is no direct correlation between the black screen surface and the image viewing quality, its quality specifications are quite different from that of the white surface. It should be noted that the slight black marks on the black screen surface are inevitable appearance phenomena in the production process of industrial products, which meet the factory qualification standard.

Conclusion: it should be noted that the slight black marks and white spots on the black screen surface of the anti light projection screen products are normal product appearance phenomena, which will never affect the image viewing quality. Please use it at ease.

# Operation Guide

## 1. Precautions:

In order to ensure the projection effect and quality of this product, please comply with the following operating requirements:

- (1). Please find a suitable size ground or platform during installation, and ensure that there are no obstacles on the surface. Clean pads such as cloth, film, blankets and the like must be placed on the pad to prevent damage to the screen and frame.
- (2). Do not rub or collide with the surface of the screen and frame with hard and sharp objects.
- (3). Do not scribble on the screen. The screen is an optical product, and any damage cannot be repaired.
- (4). Do not let children touch the screen to prevent accidents or damage to the screen.
- (5). When cleaning the surface of the screen, please use a soft and clean cotton cloth or brush to wipe it gently.
- (6). Please pay attention to daily use and cleaning care.

## 2. After the product is installed, you can choose a suitable place to hang it.

**3. It is recommended that the height of the lower margin of the picture frame screen be between 0.6-0.7 meters from the ground.**

# Installation Steps

## 1. The overall installation of the

screen **Note:** During the installation process, handle it with care to avoid scratches and drop damage.

### Step 1

Choose a flat ground and place the border frame.

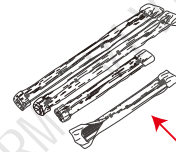
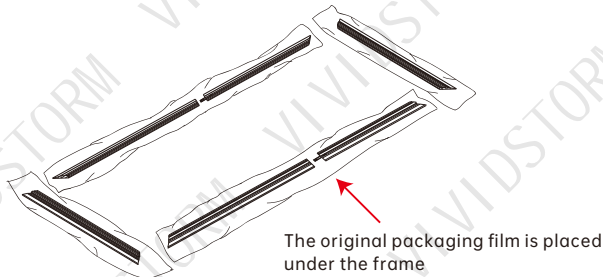

### Step 2

Insert the strip joints into the two short frames to splice into a long horizontal frame, and screw in the screws (skip this step if it is designed for the whole strip).

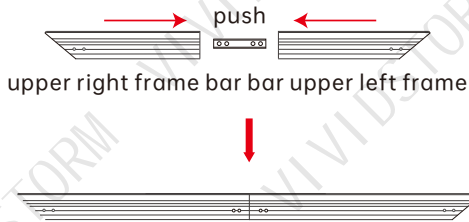

**Note:** Above 120 inches (excluding 120 inches), the long frame is truncated.

### Step 3

Install two sets of corners at the left and right ends of the left and right borders

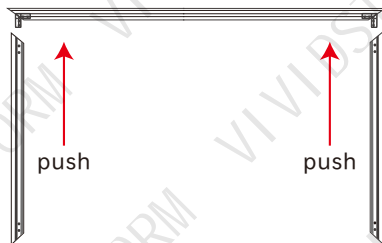

Pay attention to details:

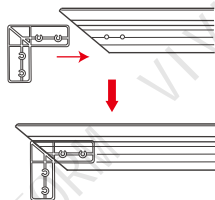

### Step 4

Repeat the above steps to connect the remaining long frame horizontally

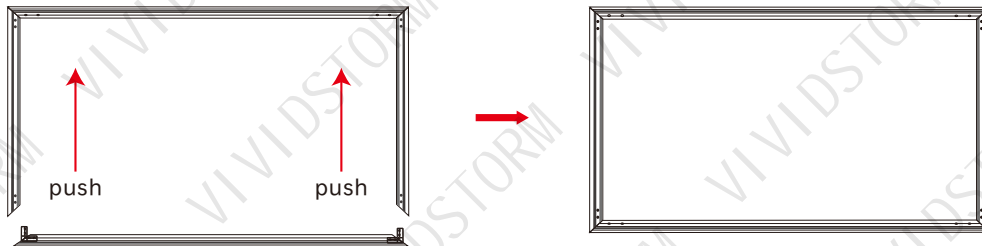

Pay attention to the detailed operation: both ends must enter horizontally at the same time.

## Step 5

Make sure the four corners of the frame are square, then secure with screws.

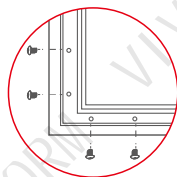
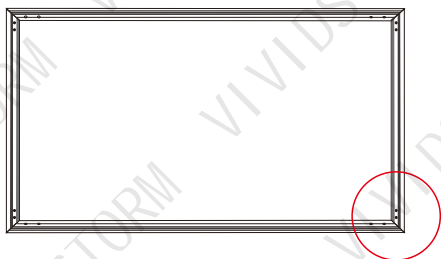

Pay attention to the detailed operation: after the four corner screws are confirmed to be fully assembled, then lock and fix.

Error demonstration 1

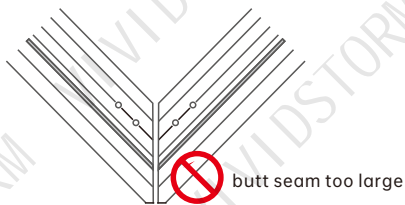

Error demonstration 2

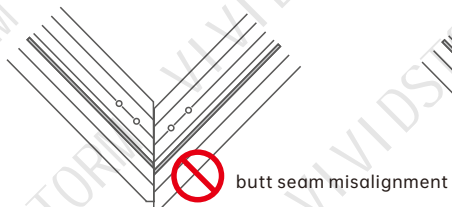

Demonstrate correctly

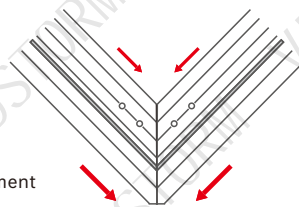

Pay attention to the details: before installing each frame connection angle piece to lock the fixing screws, you must confirm whether there is a gap between the two frames (use your hands to force the two frames inward to make the gap as small as possible, and then use a screwdriver to screws).

## Step 6

Open the curtain, and when the curtain is taken out of the wrapping paper tube, please handle it with care so as not to damage the curtain. There must not be any sundries within the dotted line to avoid damage to the screen.

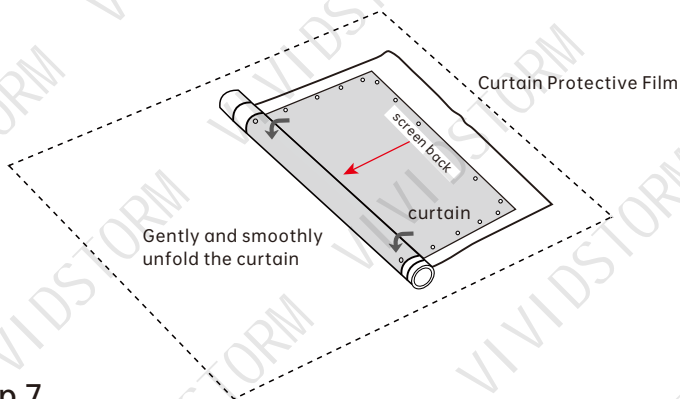

**Note:** When the curtain is unfolded, please pay attention to the label on the edge of the screen to remind: the packaging protective film of the curtain on the back of the screen should be kept under the screen.

## Step 7

Insert the two short steel wire rods 1 and 2 into the short side of the curtain surface, and insert the two long steel wire rods 3 and 4 into the long side of the curtain surface. If the steel wires 3 and 4 are of disconnected design, please pass them in from both sides respectively.

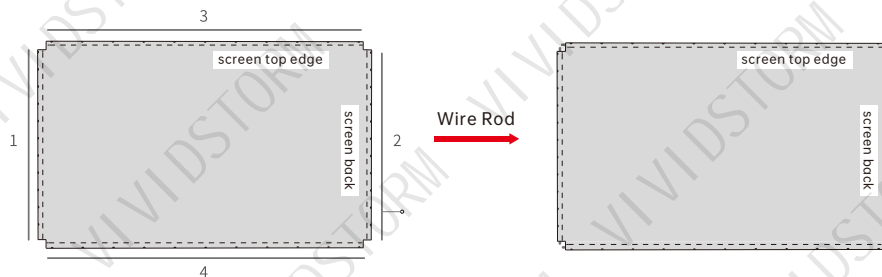

## Step 8

Move the assembled frame to the flat screen, and the frame should be located at the position where the center of the screen is divided equally.

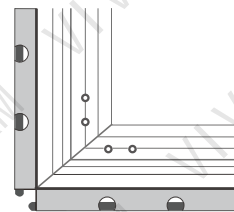
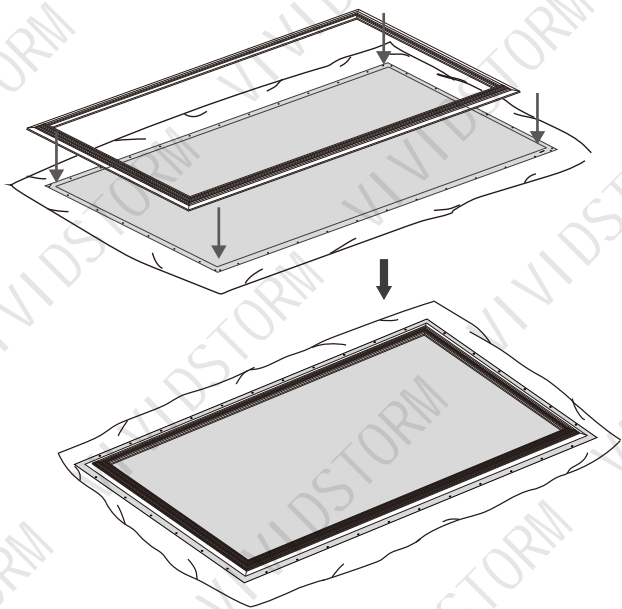

**Note:** The edge of the inner frame is equally divided with the four-sided margin of the screen.



## Step 9

Scatter the springs in the packaging bag to correspond to the holes on the curtain surface one by one, and hook the springs from the inside to the outside on the steel wire rods in the curtain surface holes, and then use the spring hooks to hang the spring elongated hooks on the frame.

1. The spring first hooks the four corners of the curtain to ensure that the installation position of the curtain is centered. Detailed operation: Two people simultaneously hook the spring according to the sequence ①-①→②-②, ③-③→④-④ as shown in the lower right figure.

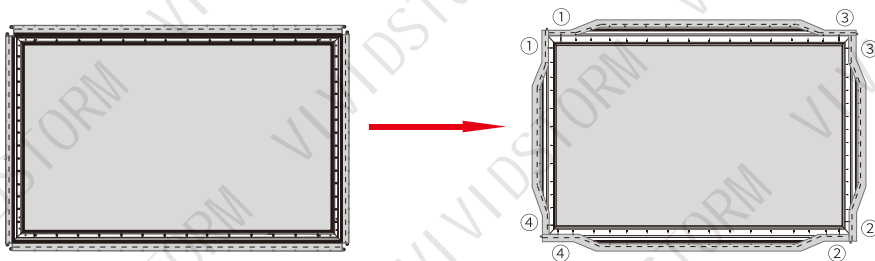

Then install the springs on the left and right sides, so that the screen surface is tensioned in the horizontal direction, and finally install the springs on the upper and lower sides.

Detailed operation: install in the order shown in the figure below, first ⑤→⑥, then ⑦→⑧. After the spring hook is hung, the curtain is raised horizontally as a whole, and the force is more even when shaken up and down slightly

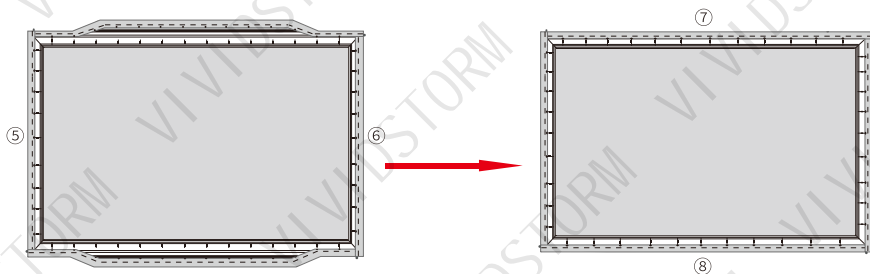

## Step 9

Note: Please hang the springs in the following order (①→②-②→③-③-③), so that the springs are always centered and evenly hung, otherwise the curtain surface will be uneven.

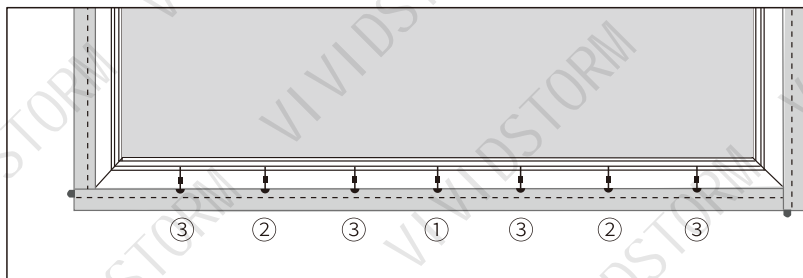

## Step 10

After the curtain surface is installed, stand up the curtain and observe whether the flatness of the curtain surface meets the requirements. Generally, small unevenness will disappear within a few hours after the curtain surface is stretched. If the corners are wrinkled, you can properly adjust the tension spring on the back and pull it left and right.

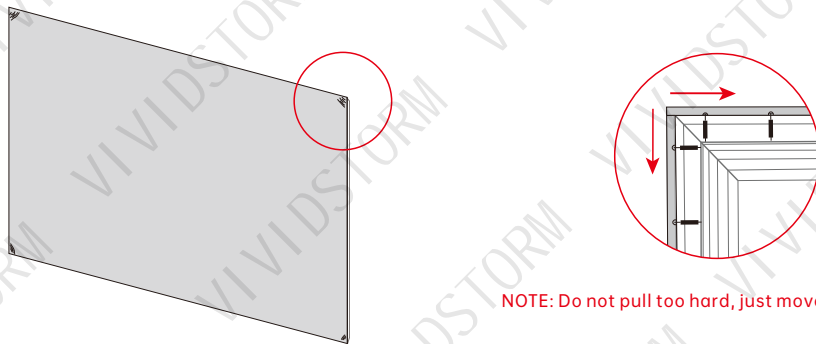

**NOTE:** Do not pull too hard, just move side to side.

## Step 11

After the curtain surface is fixed, install the outer frame. Before installing each frame connection corner piece to lock the fixing screws, you must confirm whether there is a gap between the two frames (refer to step 5). The outer frame is locked and fixed, and the installation is complete.

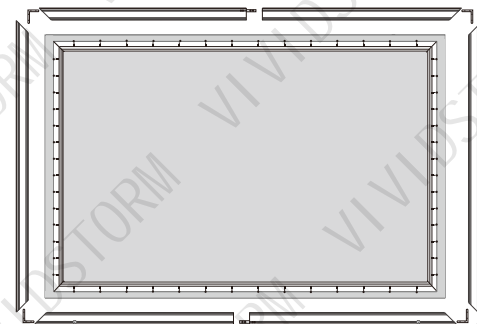

**Note:** The four corners of the outer frame are locked with gaskets and screws.

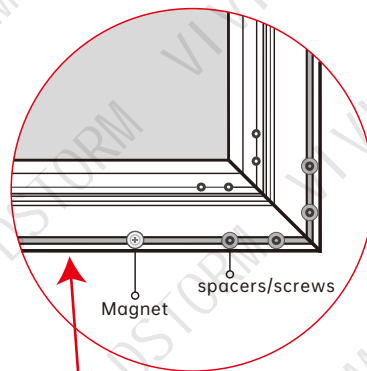

The frame containing magnets is the lower frame, please distinguish the use direction of the upper and lower frames

## Step 12

Clamp the two ends of the support rod in the center of the long frame, as shown in the figure below:

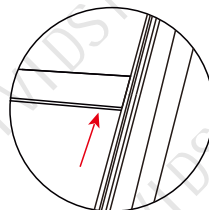
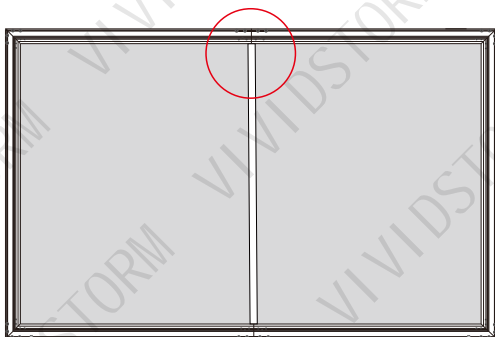

**Note:** The frame is a truncated frame to be used with the support rod.

## Step 13

In order to prevent the four corners of the curtain from being stabbed, it is recommended to put on plastic corner protectors

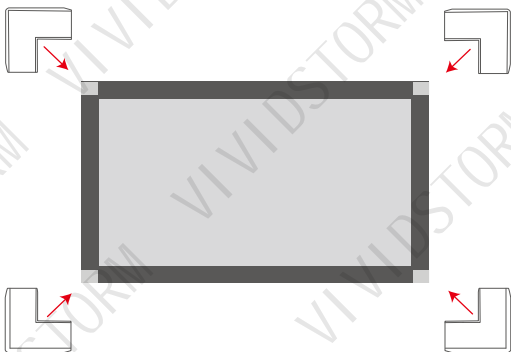

**Note:** After the screen is installed, put a plastic corner protector on each of the four corners of the screen, and the edge of the frame must completely fit into the slot of the plastic corner protector.

## 2. Installation steps on the wall

1. Determine the position of the screen according to the position of the projector. For details, refer to the height and left and right positions of each projector.
2. Determine the position of the hanging piece and install the hanging piece

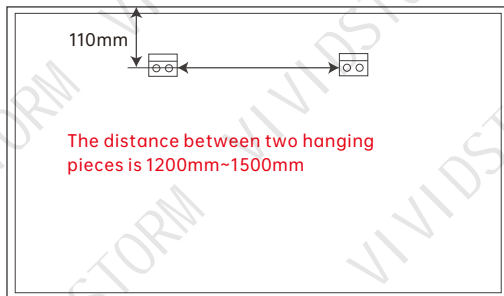

Hanger position: the distance from the upper edge of the front projection screen to the hole of the hanger is 110mm.

3. Hang the screen, adjust left and right, and the installation is complete.

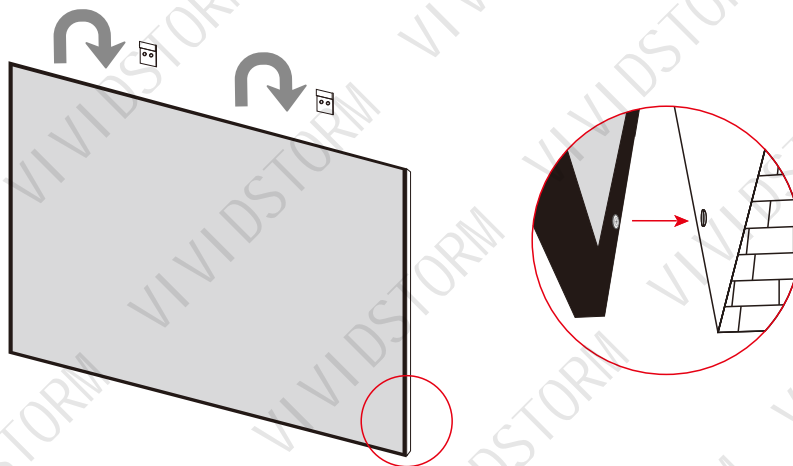

Note: If the lower edge of the screen does not fit the wall due to uneven walls, etc., you can use magnets to fix the lower edge. Method: Tear off the super glue on the back of the iron sheet, and stick it on the wall facing the position of the magnet on the lower frame behind the screen.

## Screen Maintenance

### Cleaning requirements:

1. In general, please use a soft brush to clean the screen surface. Remember to use a special soft brush and gently brush away the impurities along the screen grain direction.
2. Do not use any cloth (coarse cloth, soft cloth, gauze, wet cloth) to wipe the screen surface.
3. Rough towel or cloth may damage the screen surface and affect the viewing effect.
4. There is a horizontal structure on the screen surface, so please brush away the impurities along the left and right direction of the grain when cleaning the screen; do not wipe it up and down or round the screen.
5. The backside surface of the curtain can be wiped with cloth, but it should be ensured that the screen is dry before closing the screen, because the surface of the curtain is not waterproof.
6. Due to the weather, especially the humidity; The screen surface may be wrinkled, it is a normal situation; it can return to normal under normal temperature, and can be relieved by heating with a hair dryer.

### Warning!

- Do not scribble on the screen.
- Do not touch the screen directly by hand.
- Do not touch the screen with hard or sharp objects.
- Do not clean the screen persistently or vigorously, so as to avoid screen scratch.
- Be sure to turn off the screen when you are not using the product.
- This product is not waterproof, only suitable for indoor use, not recommended for outdoor use.
- Avoid sharp objects directly contacting the screen surface, so as to avoid puncturing or scratching the screen surface.
- Do not run the screen up and down for more than 3 minutes, otherwise the screen will stop running. This is the phenomenon of motor overheating protection shutdown. Please wait 20-30 minutes for the motor to cool down before continuing operation.
- To avoid possible injury, do not attempt to remove the screen. If there are obvious damaged parts, please contact your authorized dealer.

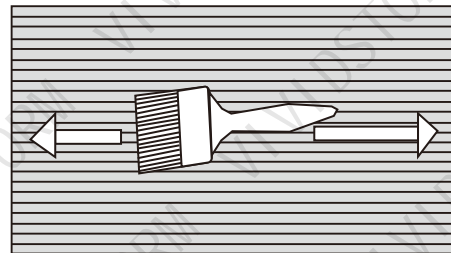

# Manufacturer's Warranty

Thank you for choosing VIVIDSTORM screens for your home or business. We are committed to providing high-quality products that meet your expectations. To ensure your satisfaction and peace of mind, we offer the following warranty policy for VIVIDSTORM screens:

1. **Warranty Coverage:** VIVIDSTORM screens are covered by a limited warranty against defects in materials and workmanship. This warranty applies to the original purchaser of the screen and is non-transferable.

2. **Warranty Period:** The warranty period for VIVIDSTORM screens is 2 Years from the date of purchase.

3. **Warranty Services:** If during the warranty period the VIVIDSTORM screen is found to have a defect covered by the warranty, VIVIDSTORM will, at its discretion, either repair or replace the defective screen or its components. VIVIDSTORM will cover the cost of parts and labor required to perform the repairs.

4. **Exclusions:**

The warranty does not cover damage or defects resulting from:

- Improper installation, misuse, or abuse of the screen
- Failure to follow the installation and operation instructions provided by VIVIDSTORM
- Accident, fire, flood, or other external causes
- Unauthorized modifications or repairs
- Normal wear and tear

5. **Warranty Claim Procedure:** To initiate a warranty claim, the purchaser must notify VIVIDSTORM by contacting our customer service department at [Insert Contact Information]. A VIVIDSTORM representative will guide you through the claim process, including providing any necessary documentation or evidence of the defect.

6. **Proof of Purchase:** To be eligible for warranty services, the purchaser must provide a valid proof of purchase, such as a sales receipt or order confirmation, demonstrating the date of purchase.

7. **Shipping Costs:** If a warranty claim is approved, VIVIDSTORM will cover the cost of shipping the repaired or replaced screen back to the customer. However, the customer is responsible for the cost of shipping the screen to VIVIDSTORM for warranty service.

8. Limitation of Liability: VIVIDSTORM'S liability under this warranty is limited to the repair or replacement of the defective screen or its components as stated above. VIVIDSTORM shall not be liable for any indirect, consequential, or incidental damages arising from the use or inability to use the screen.

Other branded products or merchandise sold on VIVIDSTORM websites are under warranty provided by the brand owner or distributor. VIVIDSTORM shall act on your behalf with the warranty claims.

9. Governing Law: This warranty policy shall be governed by and construed in accordance with the laws of country or region where the product is shipped to.

Please note that this warranty policy is subject to change without prior notice. The warranty provided herein is in addition to any rights you may have under applicable consumer protection laws.

If you have any questions or need further clarification regarding the warranty policy, please do not hesitate to contact our customer service department.

Thank you for choosing VIVIDSTORM screens. We appreciate your trust in our products.



## Certificate

Product Name: \_\_\_\_\_ Product Model No: \_\_\_\_\_  
Factory serial No: \_\_\_\_\_ Inspector: \_\_\_\_\_  
Date of production: \_\_\_\_\_

The product has been tested and inspected after operation, and all the tests and inspections have been in accordance with the technical requirements, and its quality meets the specified requirements. Only after passing the inspection can they be allowed to leave the factory.

## Product Warranty Card

User information

Customer retention sheet

Customer name: \_\_\_\_\_ Customer telephone: \_\_\_\_\_  
Postcode: \_\_\_\_\_ Customer's address: \_\_\_\_\_  
E-Mail: \_\_\_\_\_ Purchasing channels: \_\_\_\_\_

Purchase date: \_\_\_\_\_ Date of production: \_\_\_\_\_  
Invoice number: \_\_\_\_\_ Warranty content: \_\_\_\_\_  
Customer signature: \_\_\_\_\_ After sale: \_\_\_\_\_  
Date: \_\_\_\_\_

Satisfied  Dissatisfied

Manufacturer: HUI ZHOU VIVIDSTORM FILM AND TELEVISION EQUIPMENT CO., LTD.

Add: NO.66 Zhongxing North Rd , Aotou Town, Daya Bay, Huizhou City, Guangdong Province, China

Website: <http://www.vividstormscreen.com>

Email Us: [support@vividstormscreen.com](mailto:support@vividstormscreen.com)

Call Us: 0086-752-3096010

\*The final power of interpretation owes to our company



**For Your Dream Picture**