

# S PRO PLUS

Electric Tab-Tension Floor Screen

## USER MANUAL (2402)

(S PRO PLUS & S PRO P PLUS common version)



# Content

To Users -----	2	Screen Running -----	19
Safety Instructions -----	2	Manual Switch -----	19
Packing Contact-----	4	Remote control -----	20
The Introduction Of Product-----	5	Adjustment Of Screen Black Borders -----	22
Appearance-----	5	Screen Maintenance -----	23
Certificate-----	8	Manufacturer's Warranty-----	24
Important Safety Precautions -----	9	Certificate -----	26
Matters Needing Attention -----	10	Product Warranty Card -----	26
Matters Concerning Projection -----	11		
Projected Area -----	11		
Screen and projector compatibility -----	12		
About Screen Performance -----	13		
Installation Warning -----	16		
Before pre installation -----	16		
Hardware Parts List -----	16		
Ground Installation -----	17		
Wall Installation -----	18		

## To Users

Thank you for choosing the VIVIDSTORM projection screen.

Please read this manual carefully before using the product and keep it properly.

The manual of products, accessories, user interface, etc. in this description are schematic diagrams and are for reference only. Due to product updates, the actual product may be slightly different from the schematic diagram, please refer to the actual product.

## Safety Instructions

For your security and interest, to ensure safe and correct use of this product, always comply with the following precautions to avoid dangerous situations and damage to your unit:

### Safety Instructions



This symbol warns the user that uninsulated voltages within the body of this product may be sufficient to cause an electric shock, therefore, any form of contact with any part within the body is a risk of electric shock.



This symbol reminds the user to some important information related to operation and maintenance.  
Please read this information carefully to avoid incorrect operation.



Earth Terminal Ground Symbol  
This refers to using this product needs electrical grounding.



Shipping Instructions  
Please use this product's original packaging or same materials to transport this product.



This symbol reminds users do not touch the screen with hands directly.



This symbol reminds the user to stay away from the inside of the housing, especially during operation.



This symbol reminds users not to throw sundries into the housing inside to avoid mechanical damage to the screen.



Do not place the equipment near fireplaces or high temperature objects such as gas stoves, barbecue or heaters;



Keep children and pet away from the product.



This symbol reminds the user prevent hands or other body parts from entering the inside of the bracket, causing hand pinching;  
All items that are not product parts should be kept away from moving parts.



To prevent electric shock, fire hazard.

- Using incorrect cables may affect product performance, and may even lead to electric shock, fire and other accidents. In order to ensure product performance and safety, please use the same type of cable as the original cable.
- If a power extension cord is required, use a power cord with an amperage rating not lower than that of the product. Otherwise, it may cause the power cord to overheat, and even cause electric shock, fire and other accidents.
- In thunderstorm weather or when the product is not used for a long time, please unplug the power plug from the socket to avoid damage to the device caused by lightning or power line surges.
- Do not place flammable objects near this product to avoid fire.



Instructions for safe operation

- Never place the screen in an unstable location, bracket or table, to prevent the product from falling, cannot be hoisted on the ceiling, causing serious equipment damage and personal injury.
- Do not attempt to disassemble this product, there are dangerous high voltages inside that could cause personal injury. When repair is required, it must be done by trained or authorized service personnel.
- Do not place this product upright as it may tip over and cause damage.
- Make sure the product protected from rain and moisture.
- Do not immerse or expose this product to water or other liquids. If any liquid or solid object enters the cabinet, please unplug the power cord of the device immediately and ask professional service technicians to check it before continuing to use it.
- Do not place this product in the following environments:
  - Poor ventilation or narrow spaces. ● Near any device that generates a strong magnetic field. ● Direct sunlight.
  - Extremely hot, cold or humid environment.

# Packing Contact

When opening the box, check the contents of the box the list below. If there is any omission, please contact the dealer in time.



Projection screen



User manual+Envelopes

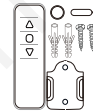

RF wireless remote  
(includes accessory)

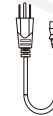

Power cord



Small screws for  
bottom fixed base



Special cleaning  
brush for UST ALR  
screen material(gift)



Cleaning stickers  
for UST ALR screen  
material(gift)

NO.	Accessories Name	Quantity (pcs)
1	Projection screen	1
2	User manual+Envelopes	1
3	RF wireless remote (Contains 1 button cell battery) (includes accessory)	1
4	Power cord	1
5	Small screws for bottom fixed base	4
6	Special cleaning brush for UST ALR screen material(gift)	1
7	Cleaning stickers for UST ALR screen material(gift)	1



## Notice:

- Parking contact will be different for different countries (regions), Please refer to the actual item.
- Please keep the original packaging for future shipments.
- Gifts are not covered under warranty.
- In special cases, the battery will be taken out before transported. (Please contact the seller to inquire about the situation)

# The Introduction Of Product

## Appearance

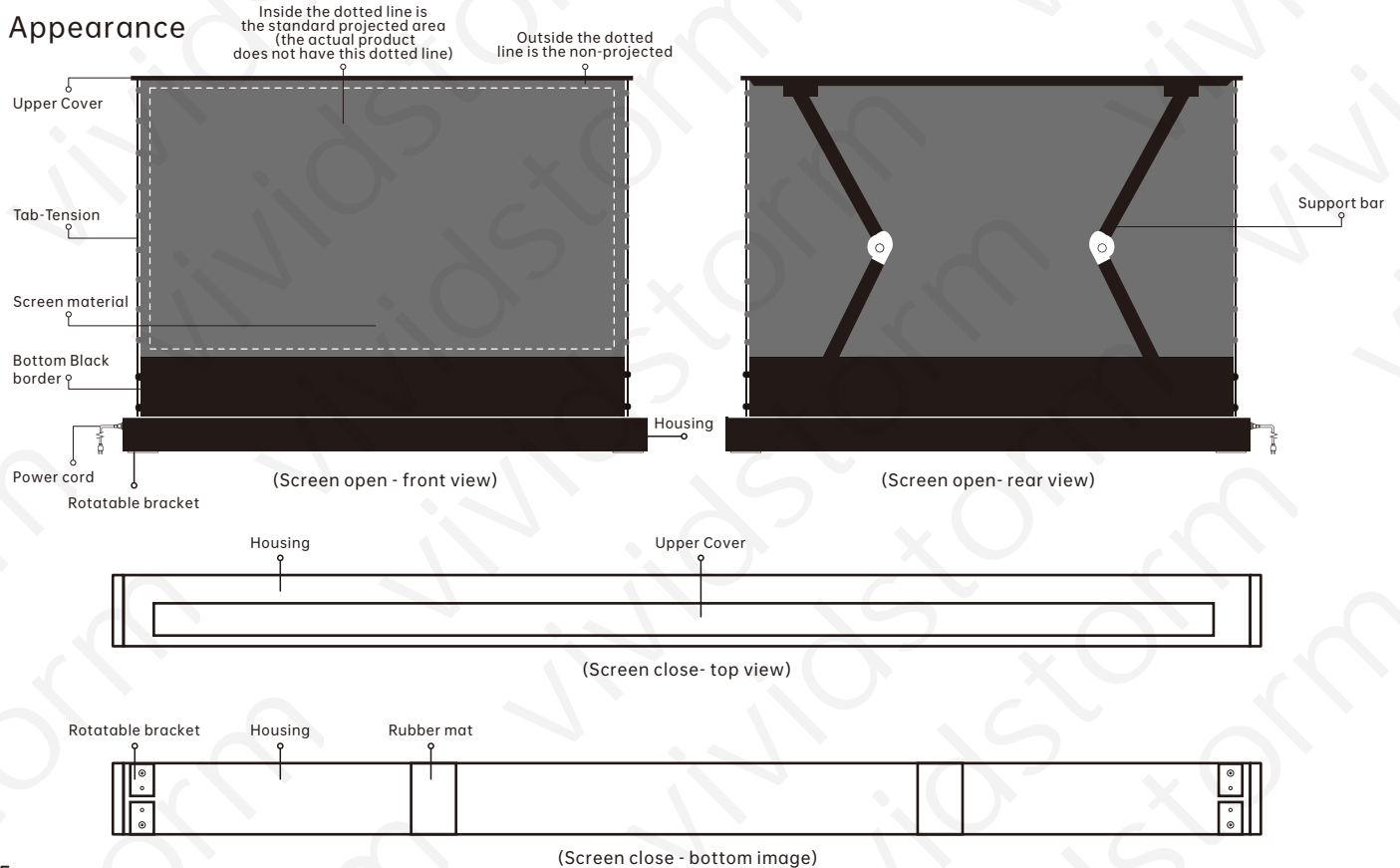

# Appearance

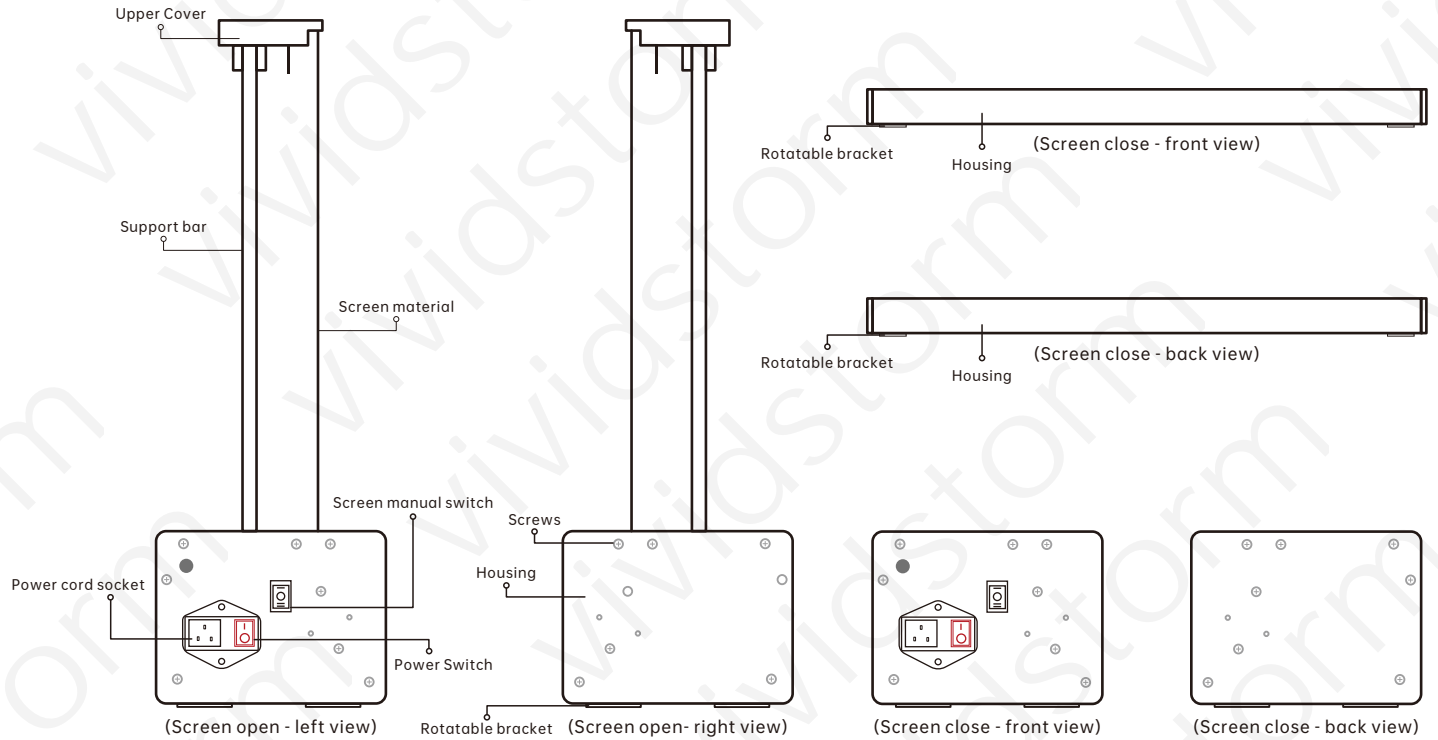

# Appearance

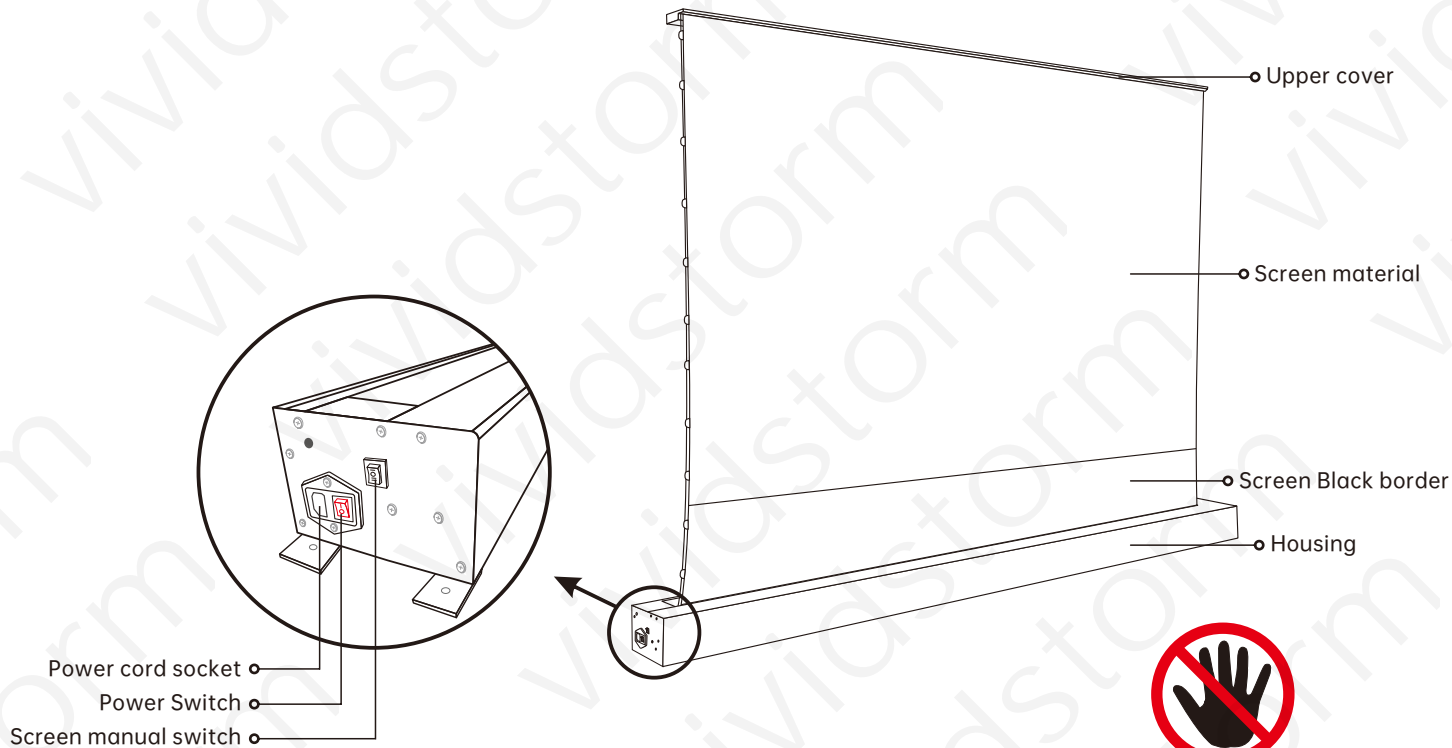

Schematic diagram of left end cover



**Do not touch  
the screen material**



## Pilot lamp

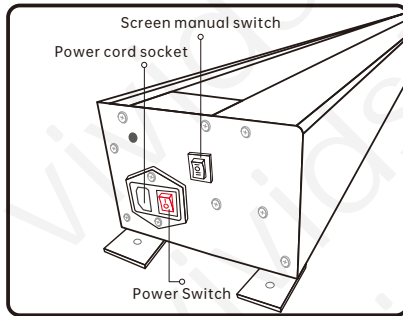

(Picture 1)

### Power lamp, make the following prompts for the working status:

- In the left picture (picture 1), make sure that the power cord plug is inserted into the product socket. After turning on the red power switch, the red light is on to indicate the power-on state; when the power switch is turned off and the red light is off, it is the poweroff state;

## Certificate



## RoHS



\*The right to interpret the above certification belongs to our company

# Important Safety Precautions

**Please read all the contents of the user guide carefully and follow the operation steps below.**

For reference when necessary, please keep this user guide.

1. In order to avoid damage to the equipment, please prohibit the use of any accessories not authorized by the manufacturer.
2. Be sure to handle the products carefully during transportation, so as to prevent product damage caused by collision.
3. In order to ensure the personal safety of the user and realize the reliable operation of the equipment, please make sure to use the power cord provided by the equipment to connect the power supply for charging.
4. Please place the device close to the power socket to connect the power supply for charging.
5. You need to place the product properly. Please do not place any heavy objects on the power cord and screen to avoid danger or operation obstacles.
6. In order to avoid electric shock, short circuit or fire caused by loose plug, please use the power cord correctly.
7. Since this product is equipped with a V-spring support system with strong tension, removing the screen without permission will bring certain risks. Please do not disassemble the screen by yourself. In case of machine failure caused by your improper operation, the seller and the manufacturer have the right not to be responsible for replace the product. In case of personal injury, no liability shall be assumed.
8. **The tubular motor on the electric screen of this product has a temperature control sensor with overheating protection mechanism. If the screen runs up and down continuously for One and a half minutes, the motor will rest for more than 30 minutes.in order to prevent the motor from overheating and damage,If the motor stops operation due to the start of overheat protection mechanism, please turn off the power and wait for 30 minutes to 2 hours until the motor cools down.**
9. The remote control supplied with this product contains coin / button cell battery. If the coin / button cell battery is swallowed, it can cause severe internal burns in just 2 hours and can lead to death. Keep new and used batteries away from children. If the battery compartment does not close securely, stop using the product and keep it away from children. If you think batteries might have been swallowed or placed inside any part of the body, seek immediate medical attention.

## Matters Needing Attention

No one is allowed to open the inside of the equipment and repair the product without authorization, except for the authorized technicians.

1. Please make sure that the power supply connected to this product has stable current.
2. If you need to use the extension cord for this product, please make sure that the power cord rating of the extension cord is the same as that of this product, so as to avoid equipment damage due to overheating.
3. When your hands and feet are in contact with water, do not operate the power plug in this case.
4. When you encounter heavy rain, wind, thunder or lightning in the process of using this product, please be sure to disconnect the power line.
5. The curtain of this product should not be placed in direct sunlight, rain and humid environment.
6. In order to prevent the product from overheating, keep away from fire source and high temperature equipment when using this product. At the same time, the power supply of this product should be cut off before transportation or maintenance.
7. Like any other household appliances, when this product is not used for a long time, please completely disconnect the power supply to ensure safety.
8. If there is any obvious damage to any parts of the product, in order to avoid any injury and electric shock, please do not continue to use.
9. When installing in the residential and commercial buildings, users should provide reasonable protection for the products to prevent the radiated RF energy from interfering with the operation of the products. However, there is no guarantee that the product will not be disturbed in special installation.

**\*Notice:**

- Do not to throw debris and foreign objects into the housing inside to avoid mechanical damage to the screen;
- The seller and the manufacturer are not responsible for any damage to the equipment caused by this;
- Before the screen is turned off, please make sure that there is no sundries in the cover.



# Matters Concerning Projection

## Projected Area

1. Please project according to the actual projection size of the screen purchased when using the projector.
2. Since the position of black border has been preset on the screen of this product, please do not exceed the specified projected area during projection. You should note that the default black border is not the projection area.

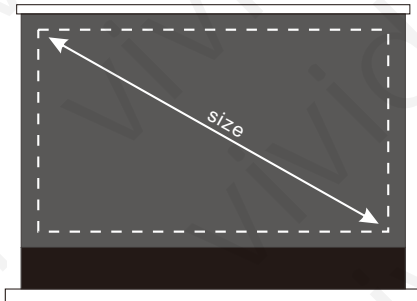

Brand-new product design:  
Screen without black border, black  
border size has been preset

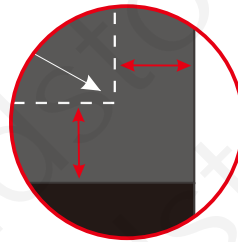

Black border has been preset

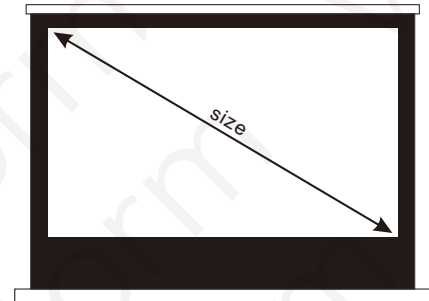

Classic product design:  
Screen with black border



## Screen and projector compatibility

Please note that the screen of this product is only suitable for use with Ultra short throw laser projector. If it is used with other projector, the effect of picture will be greatly reduced.

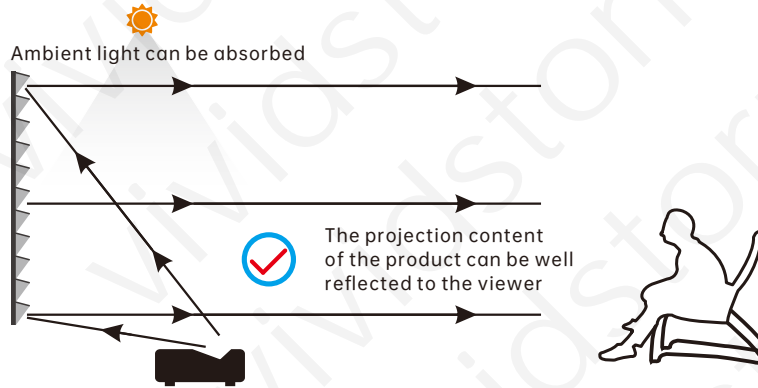

It is suggested that the ultra short focus laser projector throw ratio should be  $\leq 0.4$ . (please consult the projection manufacturer for specific parameters)

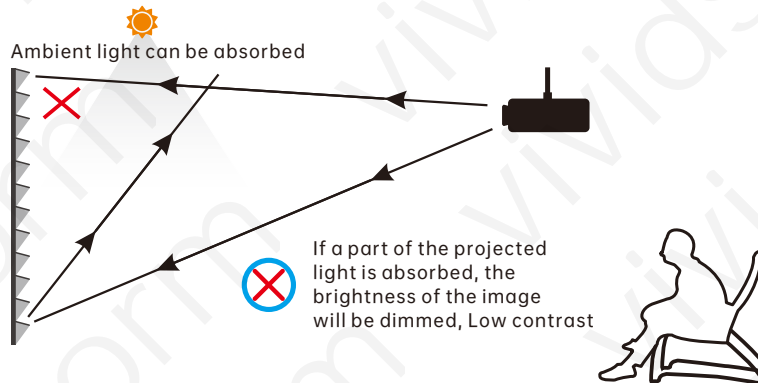

In view of the particularity of the screen structure of the product, projectors other than ultra short focus laser projectors are not compatible with this Screen fabric. If other projectors are used, the projection light may be absorbed or blocked by the Screen fabric.

## About Screen Performance

1. Please note that when placing this product, please make sure that the product is always in a horizontal state. Do not place the screen in an inclined or vertical position.

2. After using for a period of time, if the cover on both ends of the screen is slightly tilted, there is no need to worry. This is a normal phenomenon and does not affect the viewing and use. In addition, due to the cover warping, there is a gap between the screen and the housing case after closing, which is also a normal phenomenon.

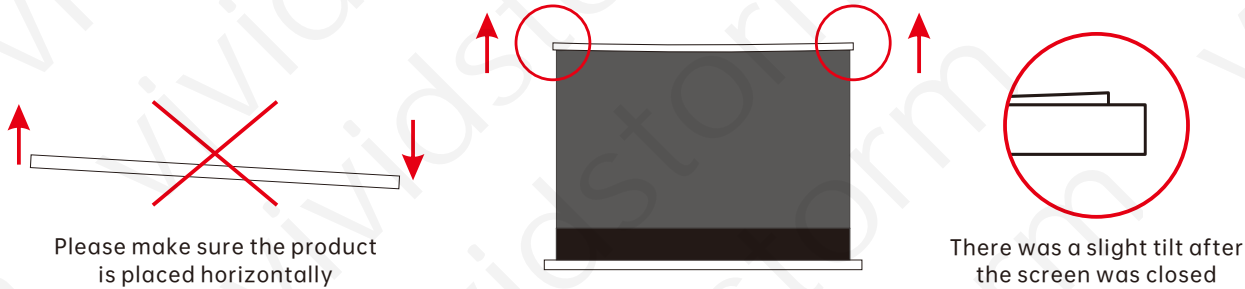

3. If there are regular creases on the screen surface after the screen is opened, don't worry. This is a normal phenomenon. It is caused by the screen being curled and tightened for a long time, which does not affect the user's viewing. After opening the screen for a period of time, you will notice that the stripes on the screen will gradually disappear.

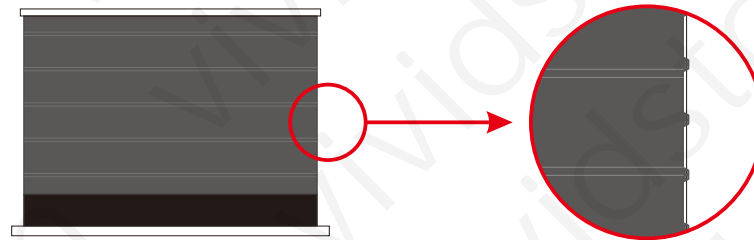

4. When there are a few black spots, white spots, stains and other impurities on the screen surface, but if they are qualified according to the detection method, then such situation is not a product quality problem, and it is within the scope of product qualification.

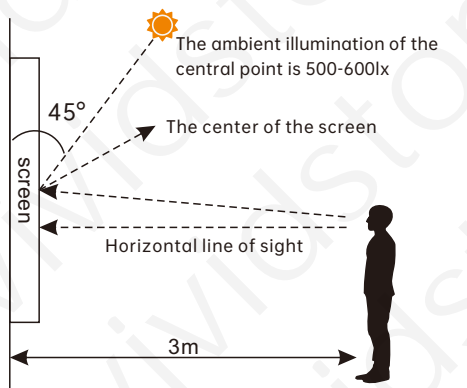

Figure 1 side view

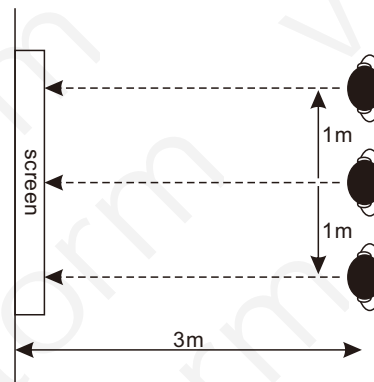

Figure 2 top view

The detection method is as follows:

- (1). Please raise the screen of this product and close to the wall, and the observer can observe the film at a distance of 3 meters away from the screen;
- (2). The observer needs to observe the shadow in the normal light environment (illumination 500-600lx);
- (3). The distance between the observer and the front of the screen should be kept at a distance of 3 meters, and the center point of the screen should be close to or higher than the horizontal line of sight (as shown in Figure 1), and the observation should be made at the center point, 1m to the left and 1m to the right (as shown in Fig. 2).

As long as the test results of the product are within the allowable range, the product is qualified.



For the black spot defect which can be measured in appearance, if it can not be found by visual inspection, the product is normal.



For the appearance of specific measurable white spot defects, if visual inspection can not be found, then the product is normal.



If the visible dirt is within the allowable range of defects, the product is normal.



For the faint linear printing trace, if within the allowable range of defects, the product is normal.



For the inks caused by uneven printing traces, if within the allowable range of defects, the product is normal.

(1).The white screen is listed as the quality standard because it is not only the reflection surface of the projector image (the black surface is observed from the upper and lower direction, and the white surface is observed from the bottom direction), but also the main function surface of the viewing image, so the white screen is listed as the quality standard. It should be noted that if the white screen surface does not exceed the quality specification, it will be regarded as meeting the factory qualification standard.

(2).Different from the white screen, the black screen is used as a functional surface to absorb indoor ambient light. In view of the fact that there is no direct correlation between the black screen surface and the image viewing quality, its quality specifications are quite different from that of the white surface. It should be noted that the slight black marks on the black screen surface are inevitable appearance phenomena in the production process of industrial products, which meet the factory qualification standard.

Conclusion: it should be noted that the slight black marks and white spots on the black screen surface of the anti light projection screen products are normal product appearance phenomena, which will never affect the image viewing quality. Please use it at ease.



## Installation Warning

Since the installation environment of each user is different, the instructions in this user guide are only for reference. If you need further installation and safety suggestions, please consult the professional installation company. It should be noted that no matter what kind of installation method you take, the product should not be loosened or dropped due to vibration or tension, so as to keep the product stable. The installation personnel of the product must ensure that the bracket accessories used have sufficient strength to support the product and select the appropriate installation position.

### Before pre installation

1. When you open the package, please carefully open the screen package to avoid the product from rubbing or falling.
2. Please always place the screen in a horizontal position. Do not install the product on an uneven or inclined surface.
3. Please keep the screen away from dust, sawdust and liquid to protect the screen from contamination.

### Hardware Parts List

Before you install the product, make sure that all parts of the product are included. Please note that the screws supplied with this product may not be suitable for all mounting surfaces. Please consult the professional installation personnel or hardware store to get the correct installation screws and anchors.

## Ground Installation

**Safety tips: it is recommended that two people lift the product and place it horizontally.**

1. When using this product, you can place the product on the horizontal ground and fix it. Before placing the product, please pay attention to cleaning the ground debris to keep the floor dry.
2. When using and rotate the four bottom supports, rotate the four bottom supports, one of which can be selected to fix the bracket according to the actual situation. It is recommended to use screws to fix the product on the ground.

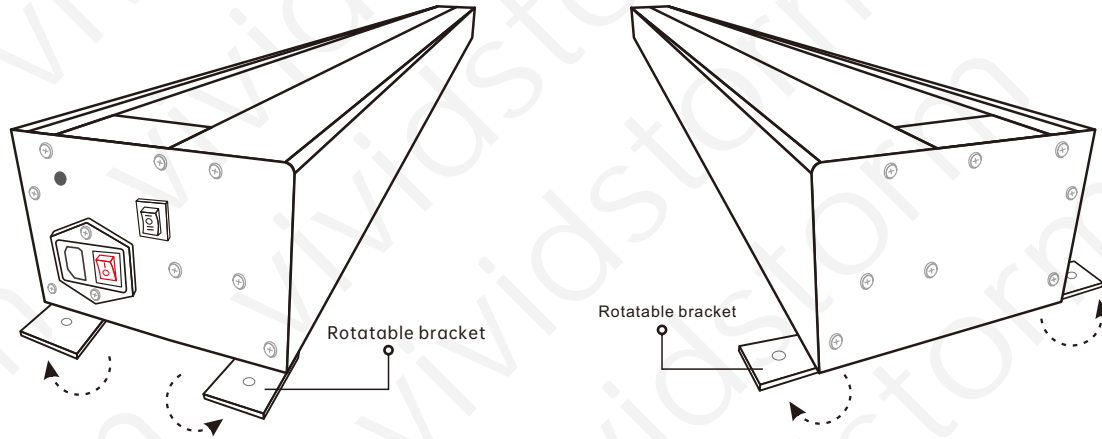

## Wall Installation (The wall hanger can be used as a reference If additional purchase it)

1. If you purchase the wall brackets, you can fix the product screen on the wall.
2. When installing the product, first you need to make a horizontal mark on the wall and mark the hole position, and then fix the wall brackets on the wall. It should be noted that when lifting the product, two people should lift and place it on the rack at the same time.



Diagram on the front of the screen

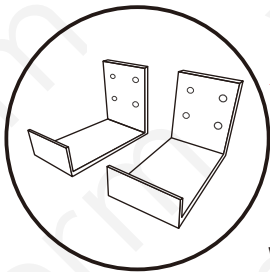

Wall brackets accessories

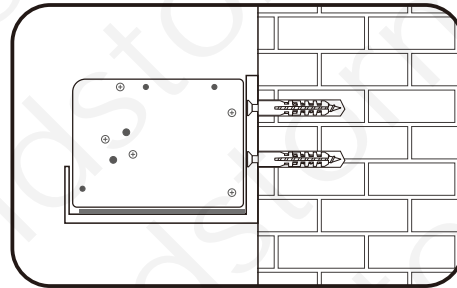
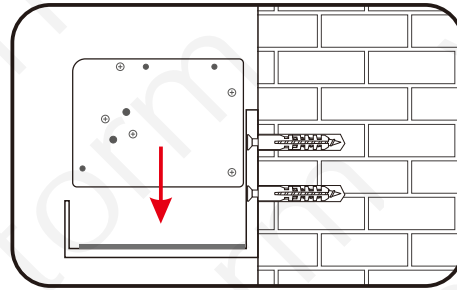

Schematic diagram of wall brackets accessories

# Screen Running

Voltage information: make sure your screen is working at the **correct voltage**, depending on the area.

- (1) Plug the screen power cord into the correct power outlet.
- (2) When the product power is turned on, a "beep" sound will be emitted for 1.5 seconds, indicating that the product has been powered on.
- (3) When the screen is fully raised, you can choose to turn off the power switch and unplug the power cord due to long-term viewing. At this time, the screen will remain open and will not be closed due to power off. To turn off the screen, connect the power cord and turn on the switch to resume operation.
- (4) When the left power switch is powered on, you can use any of the methods described below to run the screen.

**Note: when the screen is raised, make sure there is no obstacle and enough space on the top of the screen, and do not put your head on the top of the screen to avoid personal injury and product failure.**

## 1.Manual Switch

The left side of the screen shell is equipped with a manual switch which can control the screen "up / stop / down".

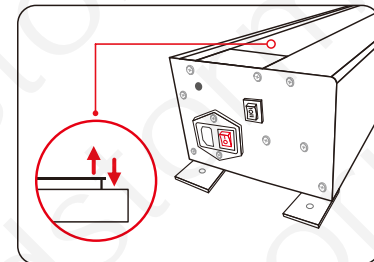
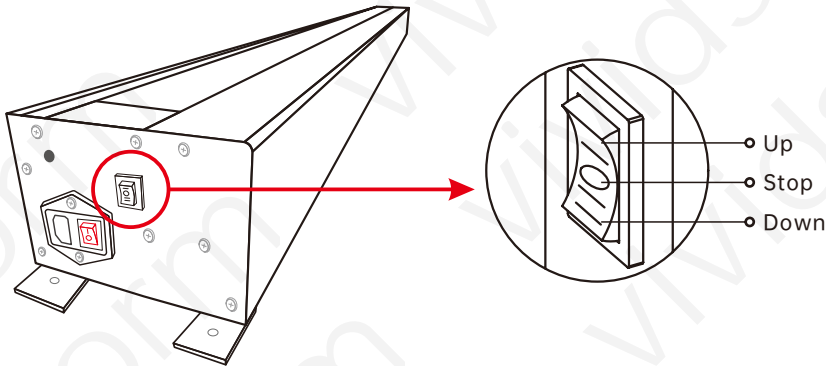

**Please note:**  
When the screen lid starts operating, there will be a slight up-and-down jitter, which is considered a normal phenomenon.

## 2.Remote control

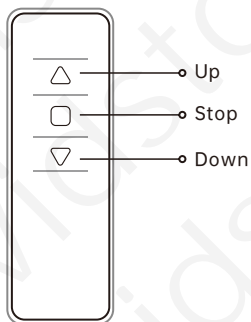

Front of remote control

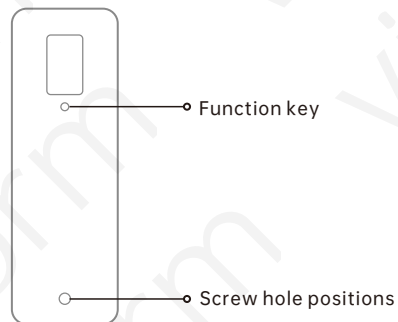

Back of the remote control

For convenient access, the remote controller can be fixed on the wall surface and other planes through the bracket. (wall screw or double-sided adhesive tape can be used for fixation)

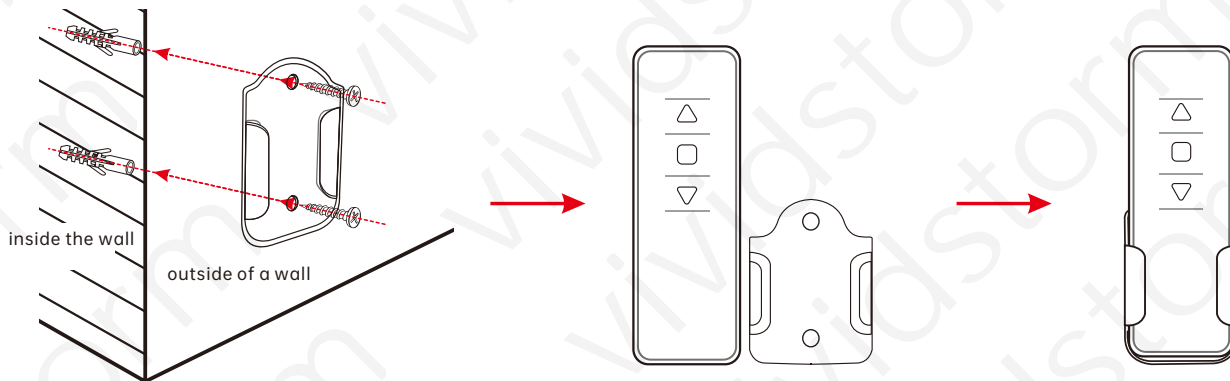

When the battery of the remote control needs to be replaced, as shown in the figure below, unscrew the cover of the remote control with a small screw, then replace the new button battery, close the cover of the remote control, and tighten the screw to prevent the loose battery from falling off;

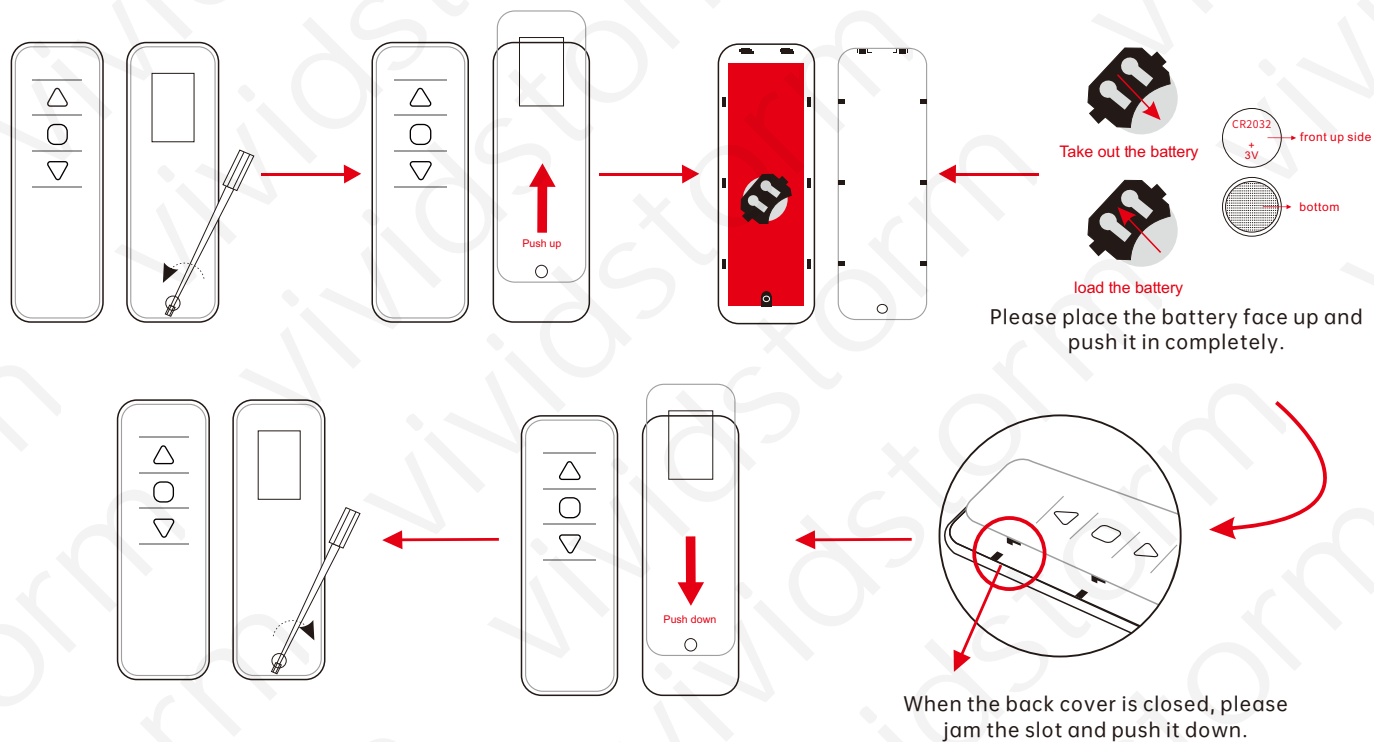

## Adjustment Of Screen Black Borders (Screen Hight Limit Setting)

①



Please ensure that the device is powered on. Begin the adjustment after fully opening the screen.

②

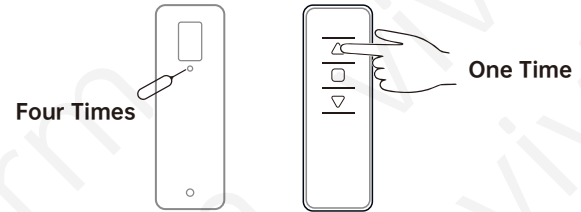

Enter adjustment mode: Use a pointed tool to press the 'Function' key on the back of the remote control 4 times, then within 10 seconds, press the 'Up' key on the remote control 1 time. At this point, the screen lid will jitter once, indicating entry into the limit adjustment state.

③

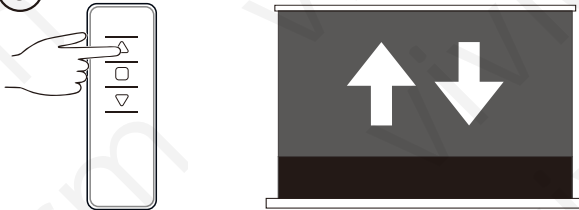

Raise the screen to the desired height. Press the 'Up' key or 'Down' key for fine adjustments based on the height requirements. For significant adjustments, press and hold the 'Up' key or 'Down' key for 2 seconds to continuously adjust the screen position."

④

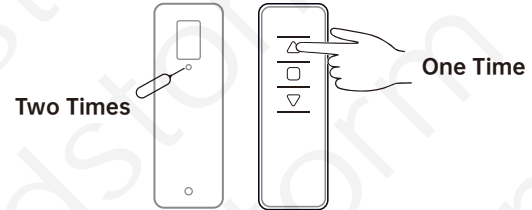

After confirming the height, use a pointed tool to press the 'Function' key on the back of the remote control 2 times. Within 10 seconds, press the 'Up' key on the remote control 1 time. The screen lid will jitter once, indicating the successful upper limit setting. Fully close and then reopen the screen to ensure the correct screen height.

**(If the height is not suitable, please repeat the adjustment according to the first step.)**

## Screen Maintenance

### Cleaning requirements:

1. In general, please use a soft brush to clean the screen surface. Remember to use a special soft brush and gently brush away the impurities along the screen grain direction.
2. Do not use any cloth (coarse cloth, soft cloth, gauze, wet cloth) to wipe the screen surface.
3. Rough towel or cloth may damage the screen surface and affect the viewing effect.
4. There is a horizontal structure on the screen surface, so please brush away the impurities along the left and right direction of the grain when cleaning the screen; do not wipe it up and down or round the screen.
5. The backside surface of the curtain can be wiped with cloth, but it should be ensured that the screen is dry before closing the screen, because the surface of the curtain is not waterproof.
6. Due to the weather, **especially the humidity; The screen surface may be wrinkled, it is a normal situation;** it can return to normal under normal temperature, and can be relieved by heating with a hair dryer.

### Warning!

- Do not scribble on the screen.
- Do not touch the screen directly by hand.
- Do not touch the screen with hard or sharp objects.
- Do not clean the screen persistently or vigorously, so as to avoid screen scratch.
- Be sure to turn off the screen when you are not using the product.
- This product is not waterproof, only suitable for indoor use, not recommended for outdoor use.
- Avoid sharp objects directly contacting the screen surface, so as to avoid puncturing or scratching the screen surface.
- Do not run the screen up and down for more than 3 minutes, otherwise the screen will stop running. This is the phenomenon of motor overheating protection shutdown. Please wait 20-30 minutes for the motor to cool down before continuing operation.
- To avoid possible injury, do not attempt to remove the screen. If there are obvious damaged parts, please contact your authorized dealer.

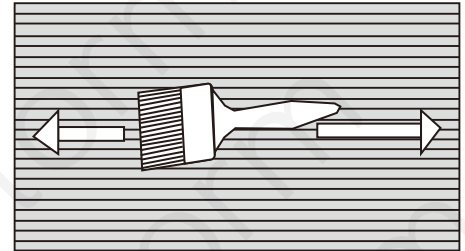



# Manufacturer's Warranty

Thank you for choosing VIVIDSTORM screens for your home or business. We are committed to providing high-quality products that meet your expectations. To ensure your satisfaction and peace of mind, we offer the following warranty policy for VIVIDSTORM screens:

1. **Warranty Coverage:** VIVIDSTORM screens are covered by a limited warranty against defects in materials and workmanship. This warranty applies to the original purchaser of the screen and is non-transferable.

2. **Warranty Period:** The warranty period for VIVIDSTORM screens is 2 Years from the date of purchase.

3. **Warranty Services:** If during the warranty period the VIVIDSTORM screen is found to have a defect covered by the warranty, VIVIDSTORM will, at its discretion, either repair or replace the defective screen or its components. VIVIDSTORM will cover the cost of parts and labor required to perform the repairs.

4. **Exclusions:**

The warranty does not cover damage or defects resulting from:

- Improper installation, misuse, or abuse of the screen
- Failure to follow the installation and operation instructions provided by VIVIDSTORM
- Accident, fire, flood, or other external causes
- Unauthorized modifications or repairs
- Normal wear and tear

5. **Warranty Claim Procedure:** To initiate a warranty claim, the purchaser must notify VIVIDSTORM by contacting our customer service department at [Insert Contact Information]. A VIVIDSTORM representative will guide you through the claim process, including providing any necessary documentation or evidence of the defect.

6. **Proof of Purchase:** To be eligible for warranty services, the purchaser must provide a valid proof of purchase, such as a sales receipt or order confirmation, demonstrating the date of purchase.

7. **Shipping Costs:** If a warranty claim is approved, VIVIDSTORM will cover the cost of shipping the repaired or replaced screen back to the customer. However, the customer is responsible for the cost of shipping the screen to VIVIDSTORM for warranty service.

8. Limitation of Liability: VIVIDSTORM'S liability under this warranty is limited to the repair or replacement of the defective screen or its components as stated above. VIVIDSTORM shall not be liable for any indirect, consequential, or incidental damages arising from the use or inability to use the screen.

Other branded products or merchandise sold on VIVIDSTORM websites are under warranty provided by the brand owner or distributor. VIVIDSTORM shall act on your behalf with the warranty claims.

9. Governing Law: This warranty policy shall be governed by and construed in accordance with the laws of country or region where the product is shipped to.

Please note that this warranty policy is subject to change without prior notice. The warranty provided herein is in addition to any rights you may have under applicable consumer protection laws.

If you have any questions or need further clarification regarding the warranty policy, please do not hesitate to contact our customer service department.

Thank you for choosing VIVIDSTORM screens. We appreciate your trust in our products.

## Certificate

Product Name: \_\_\_\_\_ Product Model No: \_\_\_\_\_  
Factory serial No: \_\_\_\_\_ Inspector: \_\_\_\_\_  
Date of production: \_\_\_\_\_

The product has been tested and inspected after operation, and all the tests and inspections have been in accordance with the technical requirements, and its quality meets the specified requirements. Only after passing the inspection can they be allowed to leave the factory.

## Product Warranty Card

User information

Customer retention sheet

Customer name: \_\_\_\_\_ Customer telephone: \_\_\_\_\_  
Postcode: \_\_\_\_\_ Customer's address: \_\_\_\_\_  
E-Mail: \_\_\_\_\_ Purchasing channels: \_\_\_\_\_

Purchase date: \_\_\_\_\_ Date of production: \_\_\_\_\_  
Invoice number: \_\_\_\_\_ Warranty content: \_\_\_\_\_  
Customer signature: \_\_\_\_\_ After sale: \_\_\_\_\_  
Date: \_\_\_\_\_

Satisfied  Dissatisfied

Manufacturer: HUI ZHOU VIVIDSTORM FILM AND TELEVISION EQUIPMENT CO., LTD.

Add: NO.66 Zhongxing North Rd , Aotou Town, Daya Bay, Huizhou City, Guangdong Province, China

Website: <http://www.vividstormscreen.com>

Email Us: [support@vividstormscreen.com](mailto:support@vividstormscreen.com)

Call Us: 0086-752-3096010

\*The final power of interpretation owes to our company



**For Your Dream Picture**