

AB-7.2T-80KPH-PAS 68/LIFT-OUT BOLLARD

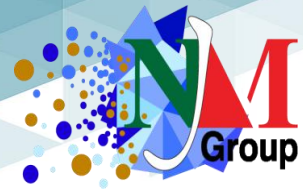

These PAS 68 engineered Bollards are able to absorb the impact of a 7.2 tonne hostile vehicle at up to 80 kilometres per-hour, the AB-7.2T-80KPH Lift Out Bollard provides security and safety to pedestrians. These Shallow Mounted protective Bollards are engineered in accordance with the IWA-14.1 Standards.

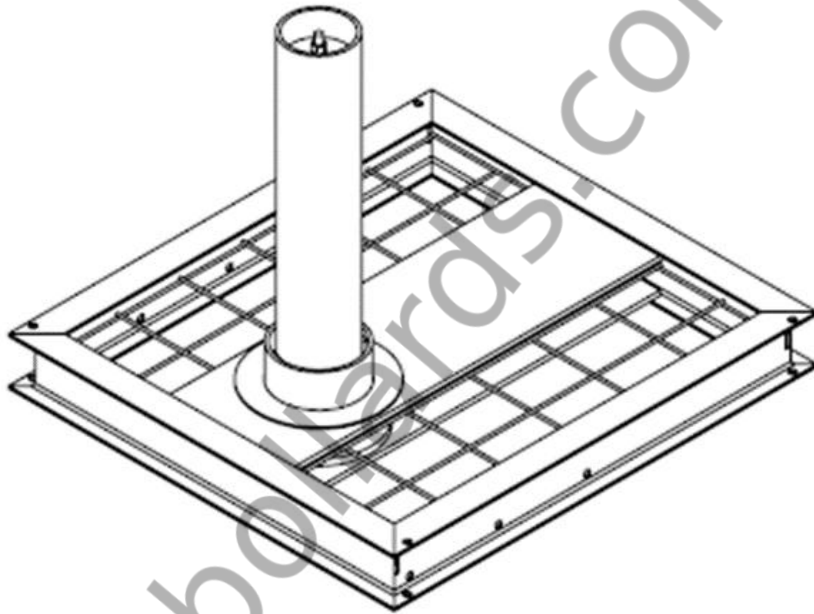

Core Diameter (mm)	273
Height Above Ground (mm)	1180
Foundation Depth (mm)	Please contact our highly trained sales team.
Sleeve Material	304 grade stainless steel. Also available in 316 grade stainless steel.
Additional Notes	Branded reflective tape also available on request.