

# BON

Maquinaria e insumos de cerrajería



## CATÁLOGO LLAVES

*Las llaves que aparecen en este catálogo son piezas JMA fabricadas por Alejandro ALTUNA S.A. o un sub-contratista de éste. Están diseñadas para cilindros y cerraduras de los fabricantes cuyas marcas se indican en este catálogo.*

*Conforme a las disposiciones legales vigentes relativas a la propiedad industrial, las marcas o nombres comerciales indicados en este catálogo son propiedad exclusiva de los fabricantes de cilindros y cerraduras, así como de los fabricantes de automóviles, otros constructores, distribuidores y usuarios.*

*Dichas marcas o nombres comerciales se indican en calidad simplemente informativa con el fin de reconocer con rapidez la cerradura a la que corresponden nuestras piezas.*

*Este catálogo está reservado exclusivamente a profesionales de la reproducción de llaves que utilizan piezas JMA.*

*Los datos referentes a los productos de este catálogo tienen carácter indicativo. Manteniendo siempre las características básicas, nos reservamos el derecho de realizar, sin previo aviso, modificaciones técnicas, estéticas o de otro tipo, por razones de evolución de los productos en cuestión.*

*Algunos modelos que están en este nuevo catálogo podrán recibirlos tanto con la marca y la referencia JMA como con otra marca del grupo ALTUNA.*



# INDICE



## **LLAVES CONVENCIONALES DE VEHÍCULOS**

BMW .....	PÁG. 5
CITROEN.....	PÁG. 6
CHEVROLET.....	PÁG. 7 - 10
CHRYSLER.....	PÁG. 11
DAEWOO.....	PÁG. 12
DAIHATSU.....	PÁG. 13
FIAT.....	PÁG. 14
FORD.....	PÁG. 15 - 16
HYUNDAI.....	PÁG. 17 - 18
HONDA.....	PÁG. 19
ISUZU.....	PÁG. 20
KIA.....	PÁG. 21
LADA.....	PÁG. 22
MAHINDRA.....	PÁG. 23
MAQUINARIA PESADA.....	PÁG. 24
MAZDA.....	PÁG. 25 - 26
MERCEDES BENZ.....	PÁG. 27
MITSUBISHI.....	PÁG. 28 - 29
MOTOS.....	PÁG. 30 - 31
NISSAN.....	PÁG. 32 - 33
PEUGEOT.....	PÁG. 34 - 35
RENAULT.....	PÁG. 36
ROVER.....	PÁG. 37
SKODA / SEAT.....	PÁG. 38
SUZUKI.....	PÁG. 39 - 40
TOYOTA.....	PÁG. 41 - 43
VOLKSWAGEN.....	PÁG. 44
VOLVO.....	PÁG. 45
NUEVOS MODELOS.....	PÁG. 46 - 51



## **LLAVES ESPECIALES DE VEHÍCULOS**

BMW / BAJAJ.....	PÁG. 52
CITROEN / FIAT.....	PÁG. 53
FORD / G. MOTORS.....	PÁG. 54
HYUNDAI / SAAB.....	PÁG. 55
HONDA / TOYOTA .....	PÁG. 56
JAGUAR / SCANIA.....	PÁG. 57
MERCEDES BENZ.....	PÁG. 58
PEUGEOT / VOLVO.....	PÁG. 59
SUBARU / VOLKSWAGEN.....	PÁG. 60



# INDICE



## **VARIOS**

ESPECIAL CILINDRO.....	PÁG. 61 - 66
TUBULARES / ESPOSAS.....	PÁG. 67
MULTIPUNTO ODIS / FIGURA Y LETRA SCANAVINI....	PÁG. 68
CILINDRO.....	PÁG. 69 - 74
CILINDRO ECONÒMICAS.....	PÁG. 75 - 81
CILINDRO COLOR.....	PÁG. 82
FASHION DISEÑO.....	PÁG. 83 - 84
CUNAS.....	PÁG. 85 - 94
LLAVES TRANSPONDER.....	PÁG. 95 - 120
INSERTOS.....	PÁG. 121 - 125





BM-HB.P



BM-2.P



SIX-1



SIX-1.P



SIX-1.P2

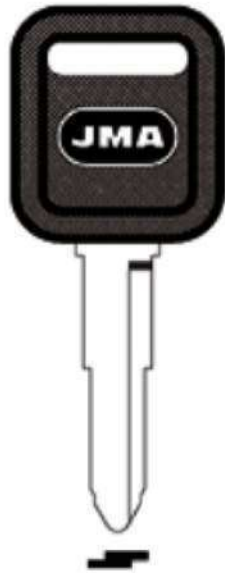

GM-1.P



GM-4



GM-4.P1



GM-5



GM-5.P





GM-14



GM-14P

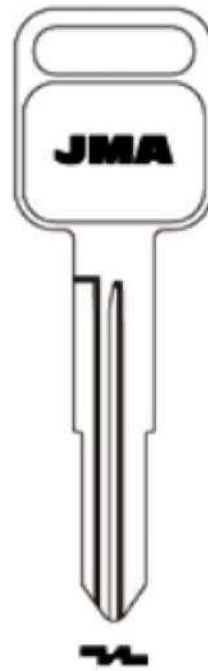

GM-15D



GM-15D.P



GM-21.P



GM-25



GM-25.P



GM-E.P

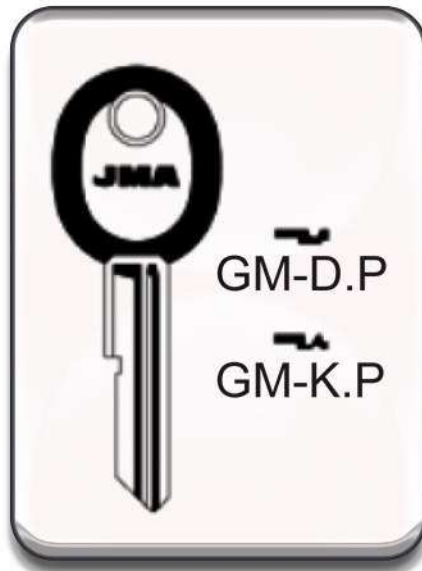

GM-D.P

GM-K.P



OP-J



  
OP-J.P

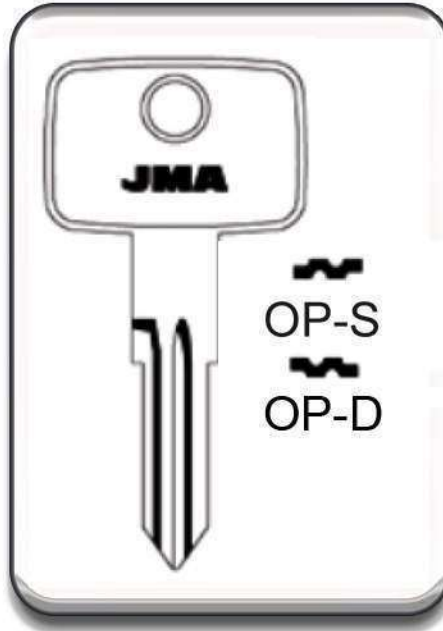

  
OP-S  
  
OP-D

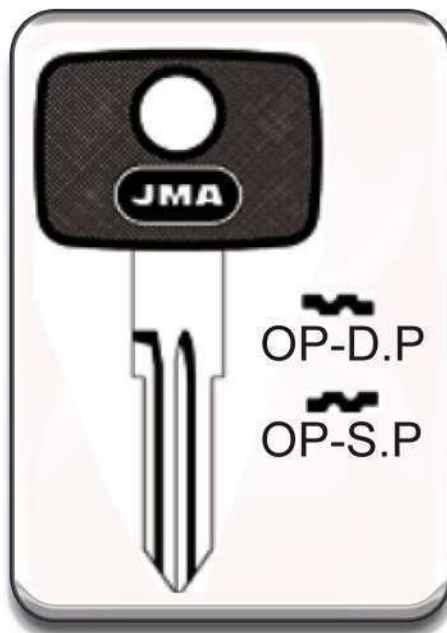

  
OP-D.P  
  
OP-S.P



  
OP-S.P1





CHR-8.P



CHR-9.P



CHR-10.P



CHR-15



CHR-15.P

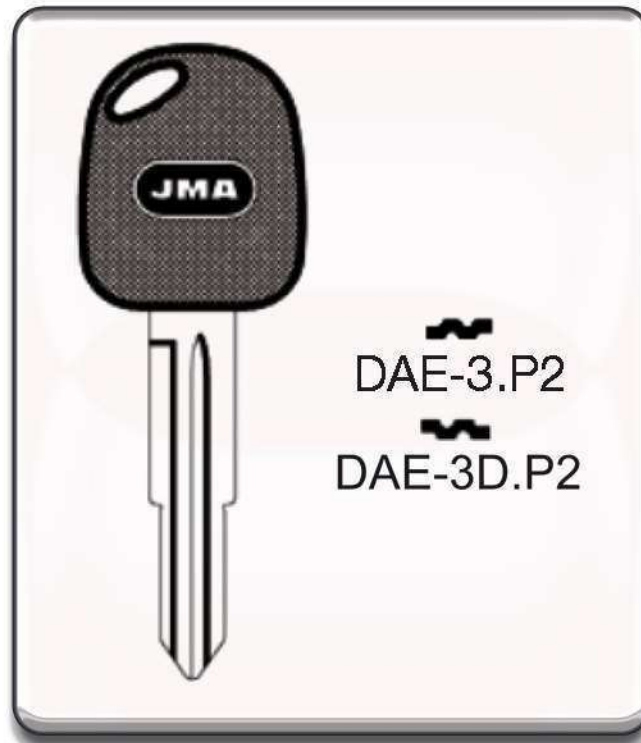
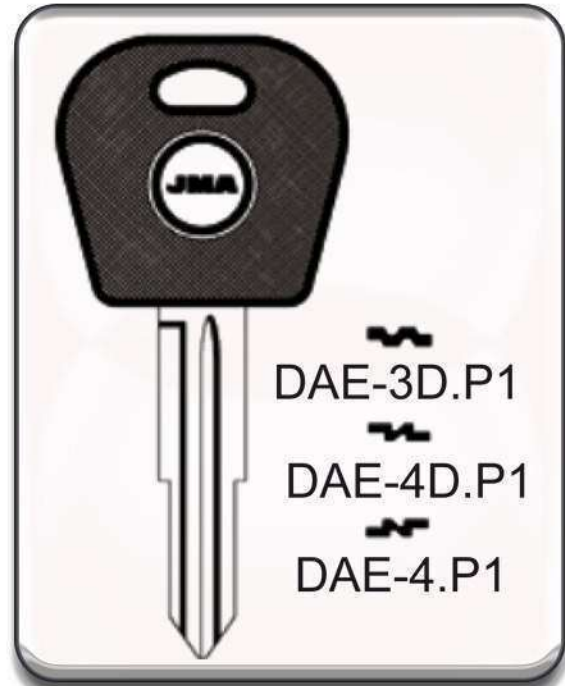

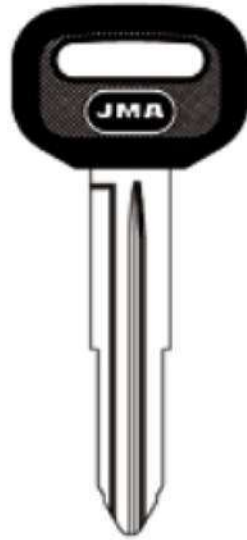

  
DAI-1.P





PJ-2.P



FI-3D.P1

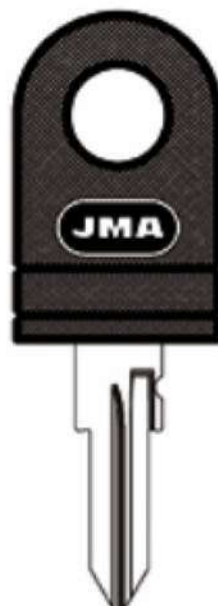

FI-6 I.P



FI-11



FI-11.P



FI-13.P



FI-13.P1



FI-13.P7

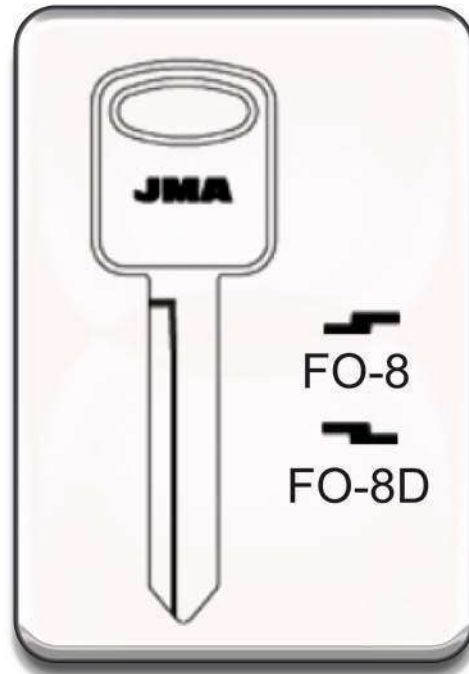
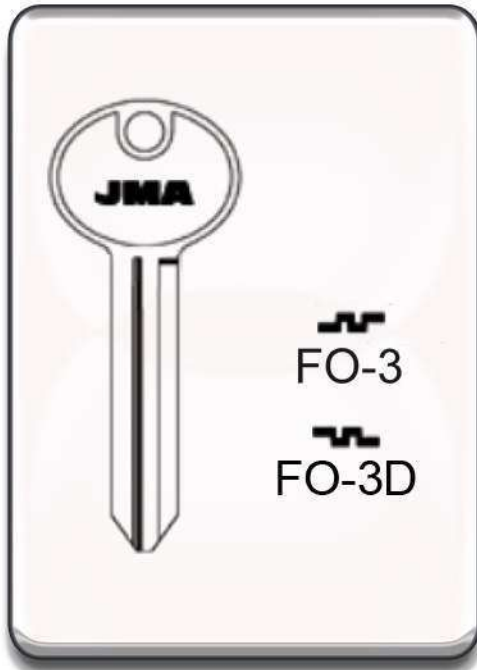

FO-8D.P

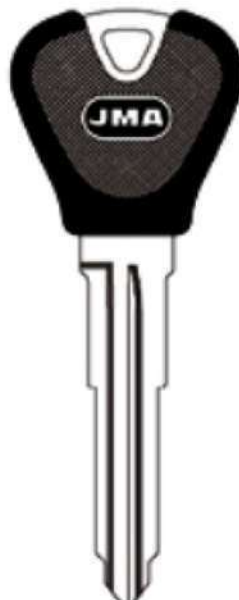

FO-9D.P



FO-10.P



FO-12.P

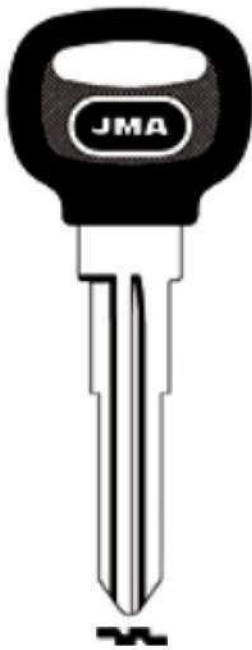

FO-13D.P



FO-15D



FO-15D.P



FO-17.P



FO-AN.P



FO-TX.P



NE-11.P3



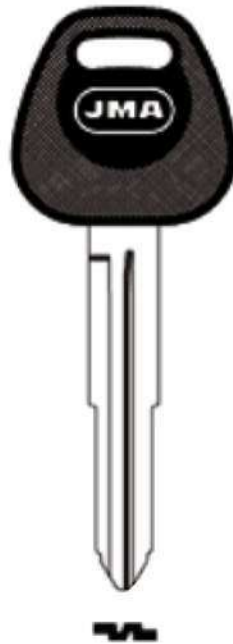
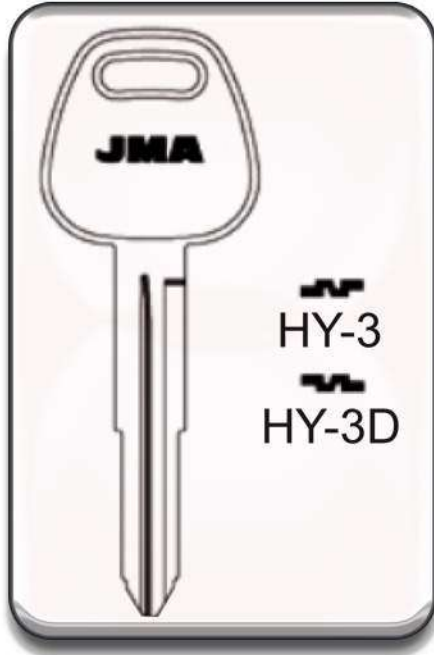

HY-3D.P1



HY-3.P2



HY-3.P3

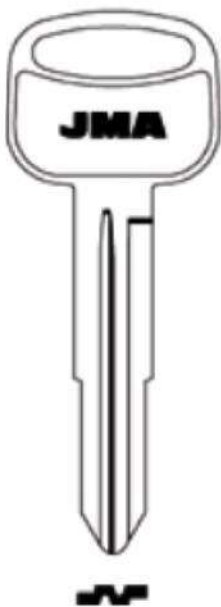

HY-4



HY-4.P



HY-4.P3



HY-5

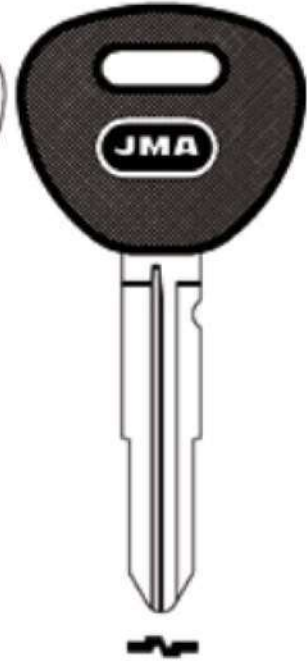

HY-5.P



  
HY-6D

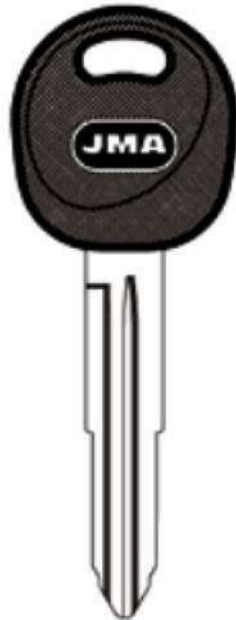

  
HY-6D.P



  
HY-7.P



  
HY-8.P



  
HY-9.P2

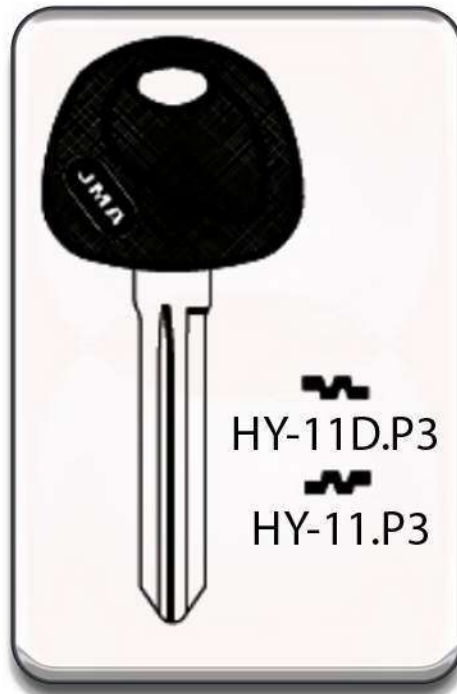

  
HY-12.P3

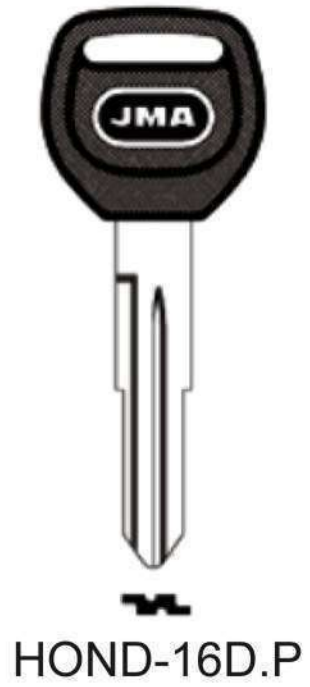
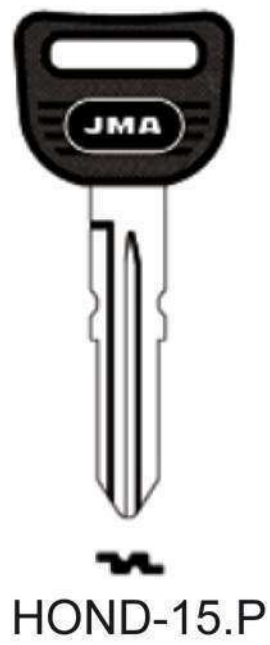
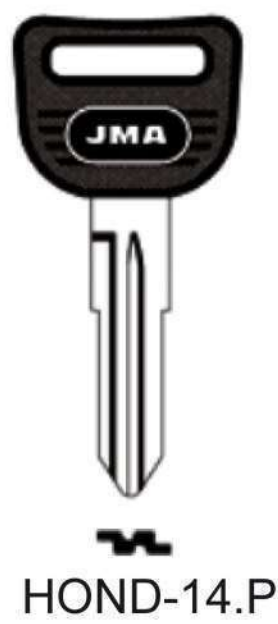
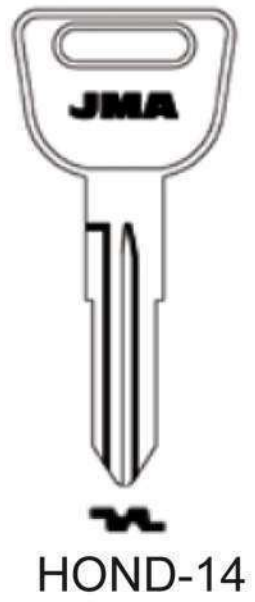
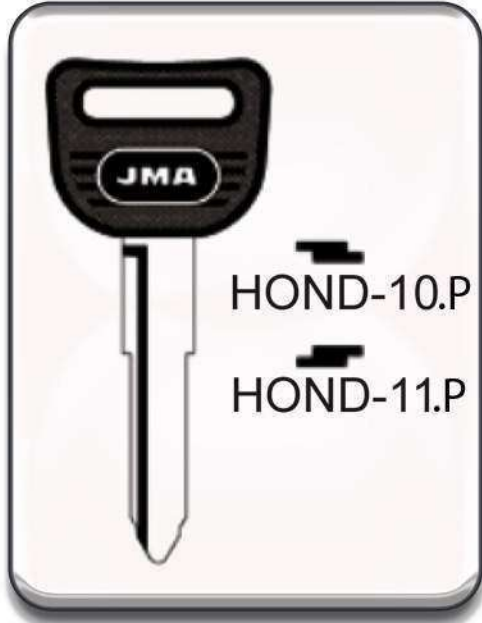
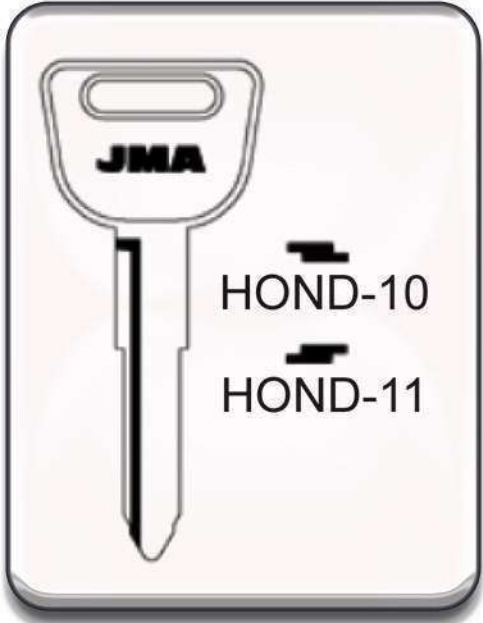





ISU-1



ISU-3D.P

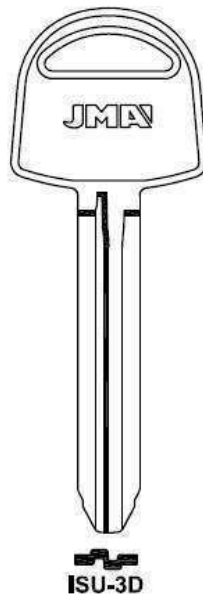

ISU-3D





KI-1D

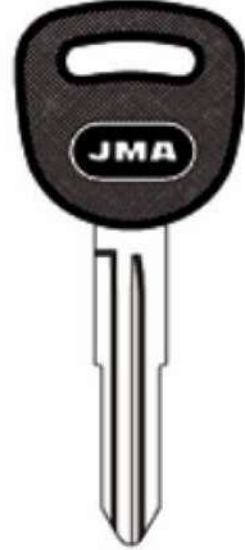

KI-1D.P1

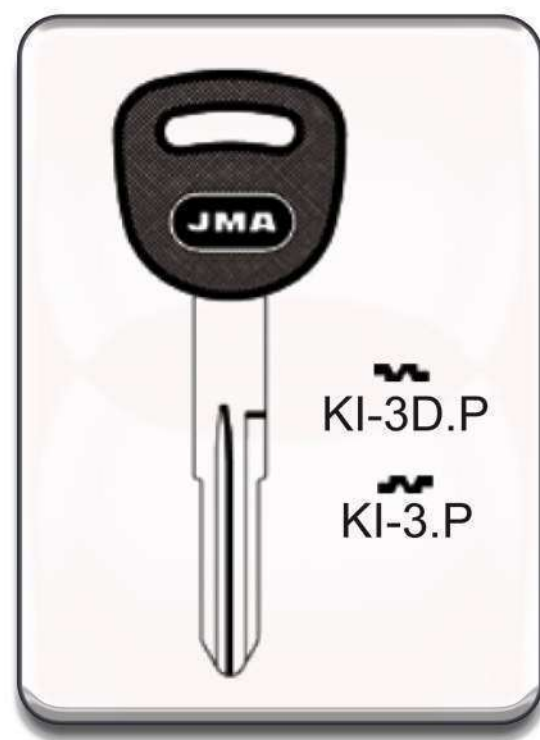



LA-1D.P



LA-2.P

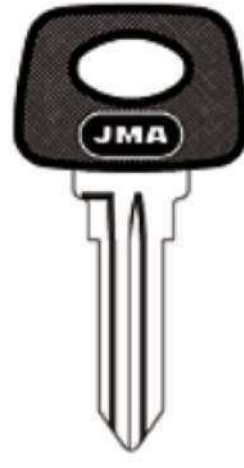

LA-3D.P



NE-3



NE-3.P



TAT-1D



TAT-1D.P





BH-4



CAT-1.P

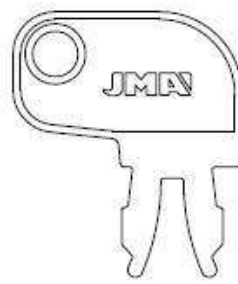

CAT-3

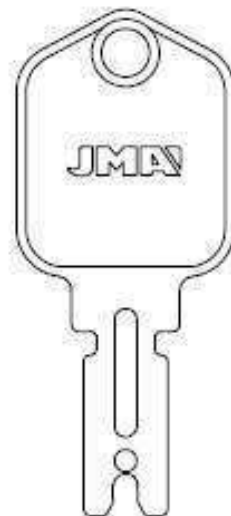

CLF-1



DAE-5.P



MERI-1D.P



TOYO-25



MAZ-2D.P



MAZ-3D.P

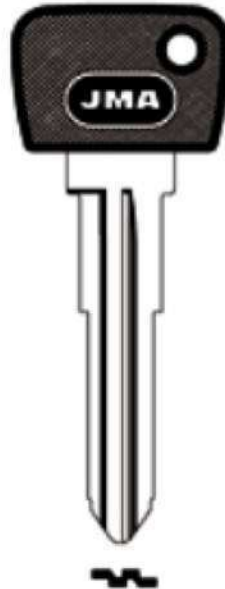

MAZ-4.P



MAZ-5D.P

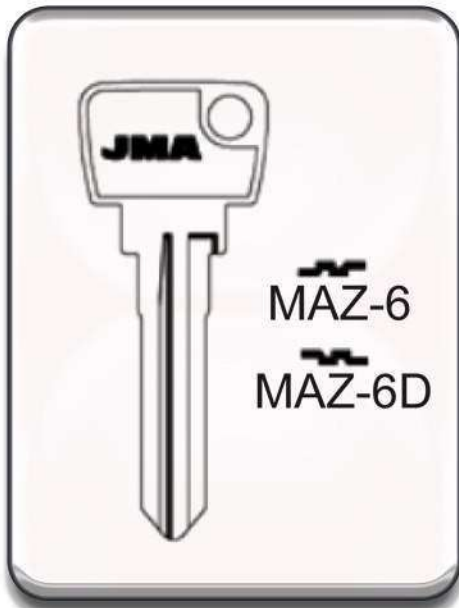

MAZ-6  
MAZ-6D

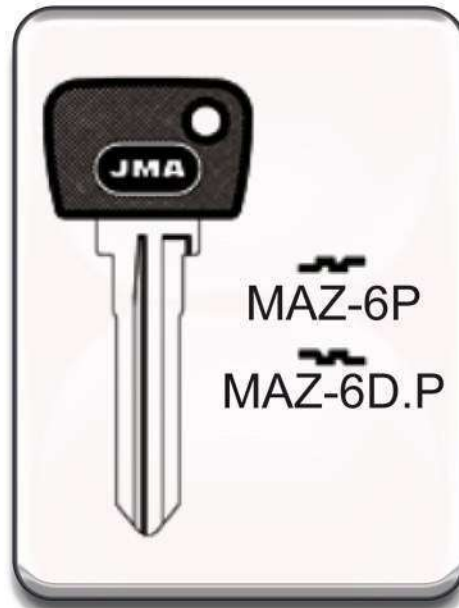

MAZ-6P  
MAZ-6D.P

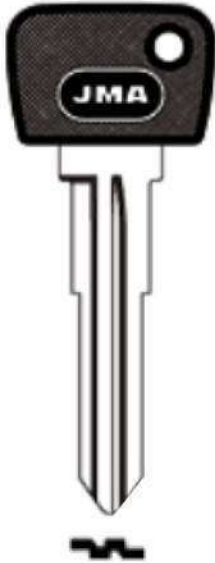

MAZ-7D.P



MAZ-8D.P

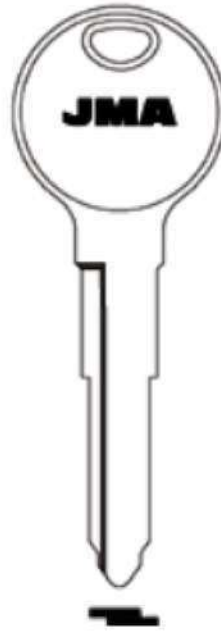

MAZ-11D

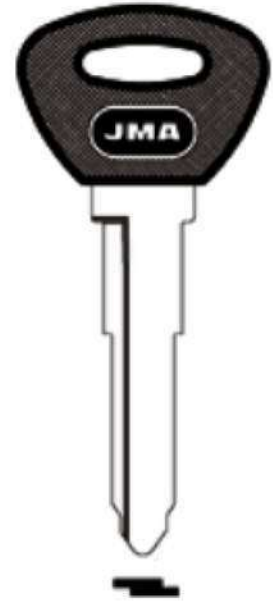

MAZ-11D.P

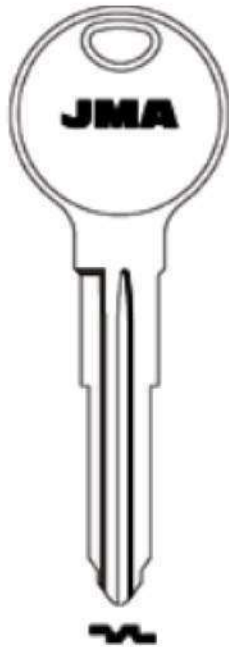

MAZ-13D



MAZ-13D.P

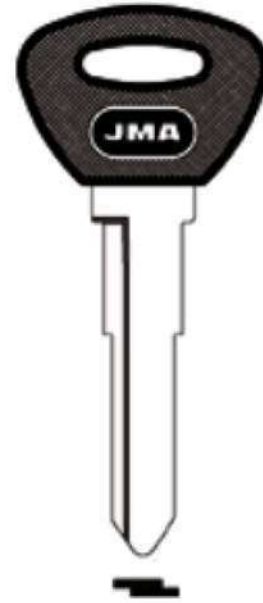

MAZ-21D.P1



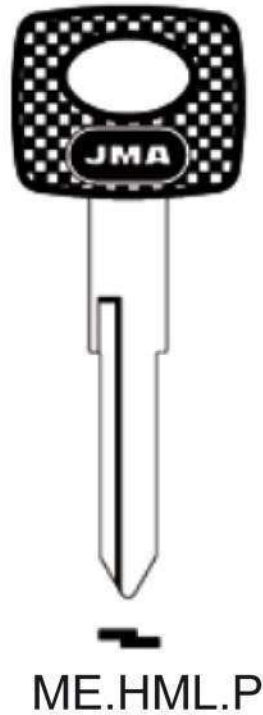
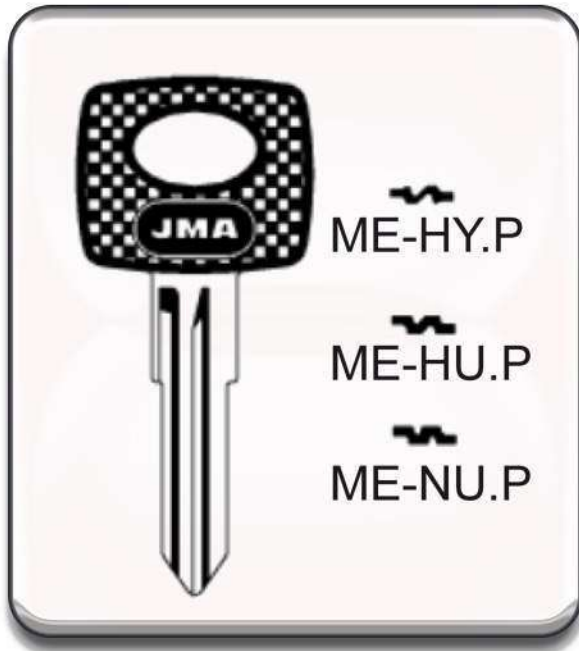
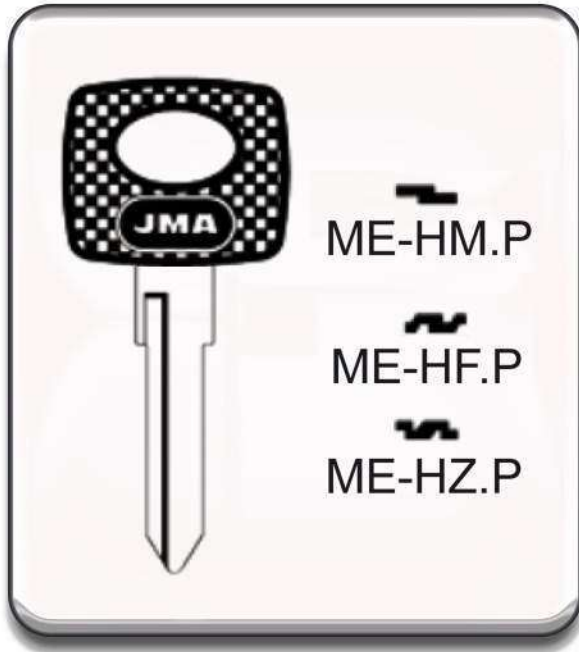

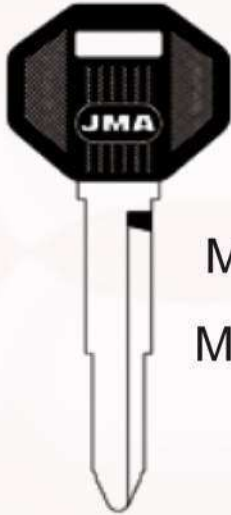

MIT-1I.P  
MIT-1D.P

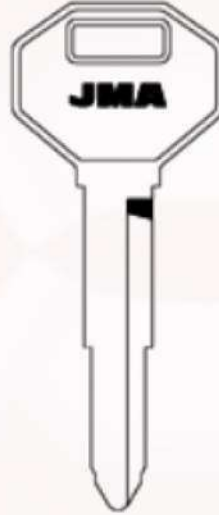

MIT-2I  
MIT-2D

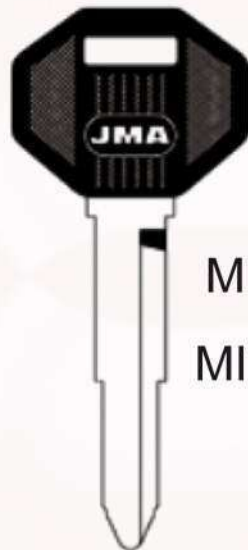

MIT-2I.P  
MIT-2D.P

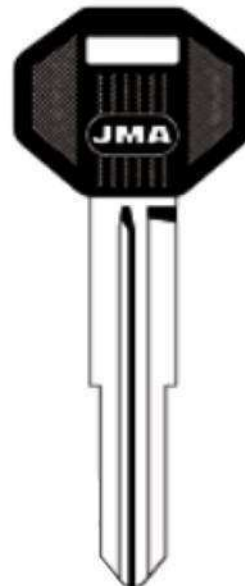

MIT-6.P



  
MIT-7



  
MIT-7.P

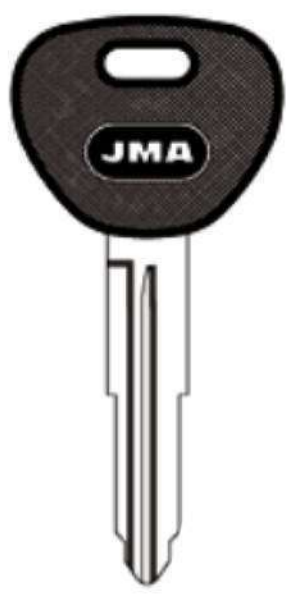

  
MIT-8D.P



  
MIT-15.P



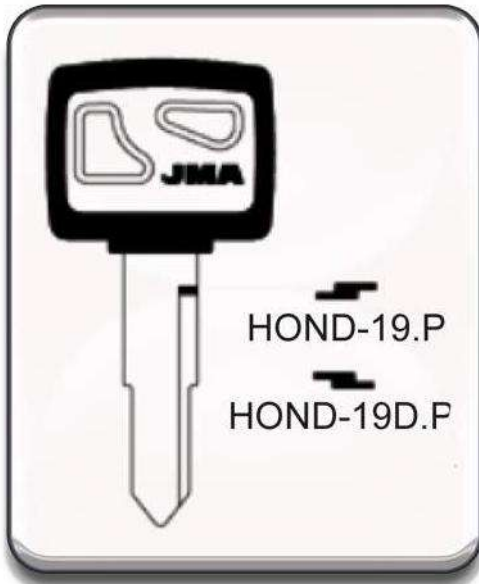
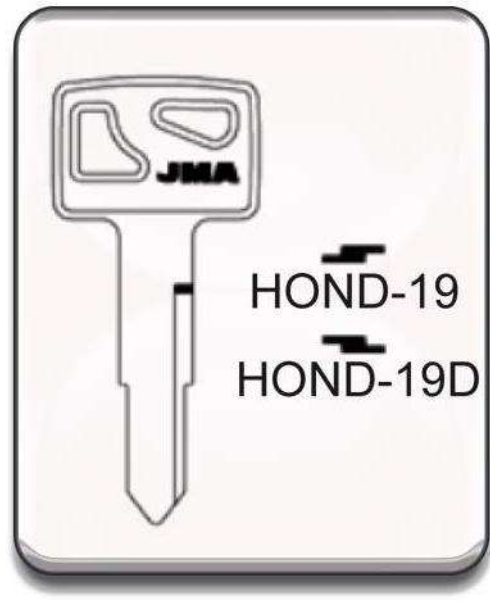
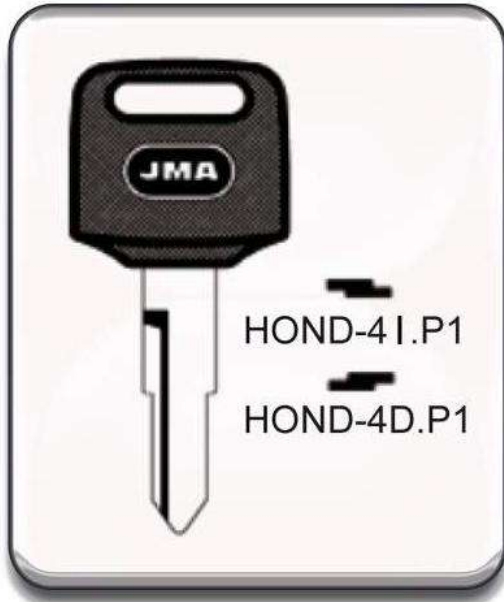

HOND-24.P

HOND-24.D.P



KAW-6.P

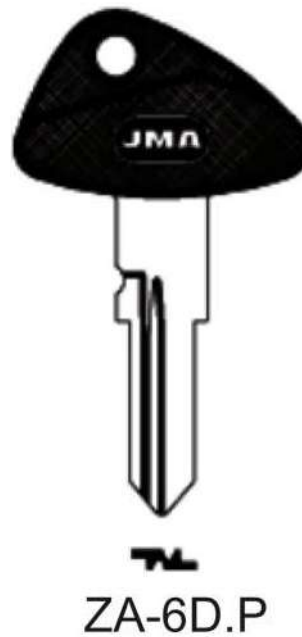
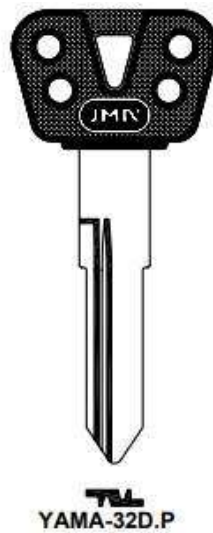
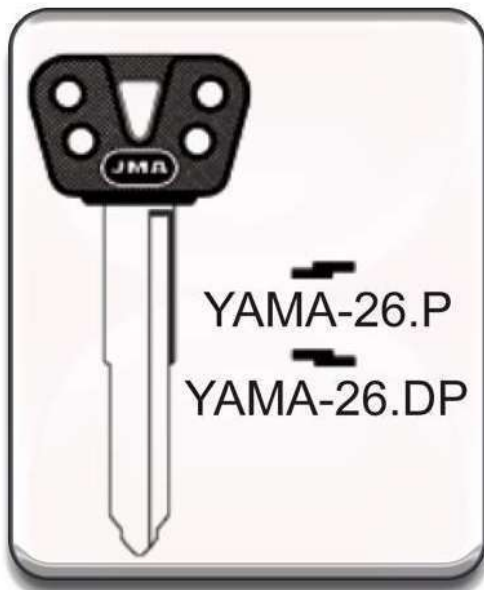
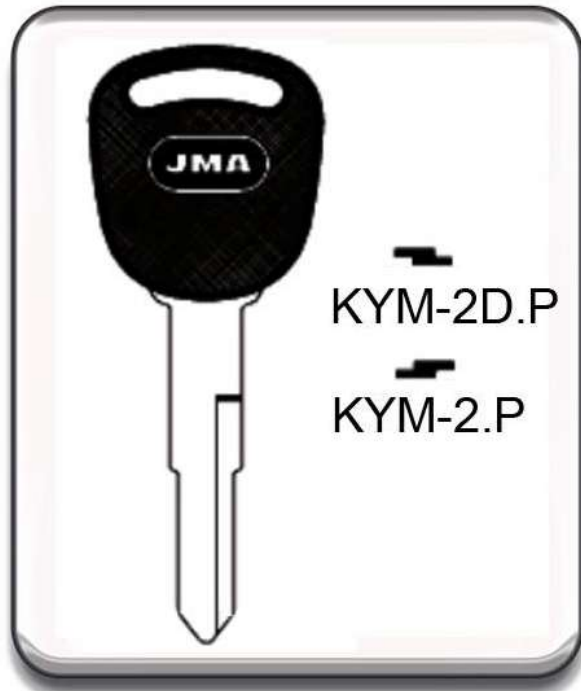



  
DAT-11.P

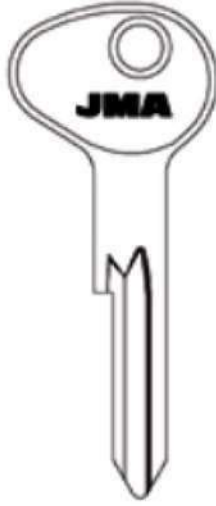

  
DAT-5D

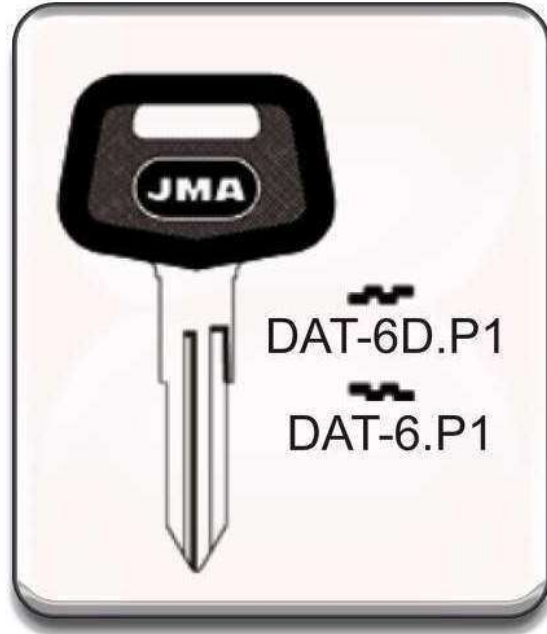

  
DAT-6D.P1  
  
DAT-6.P1



  
DAT-10



  
DAT-10.P





  
DAT-12

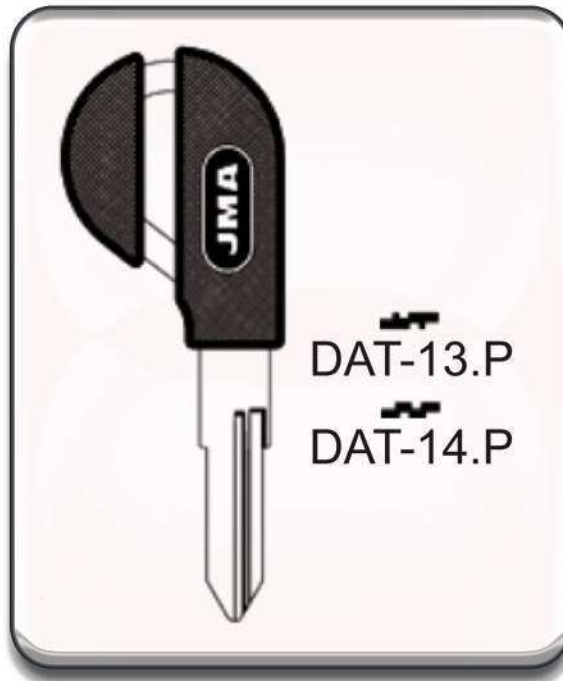

  
DAT-20.P



  
DAT-15.P



  
DAT-15



  
DAT-16

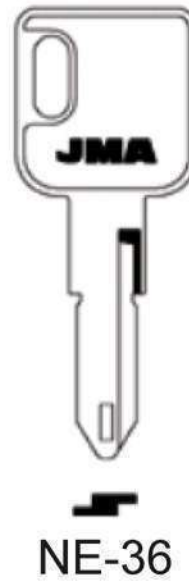
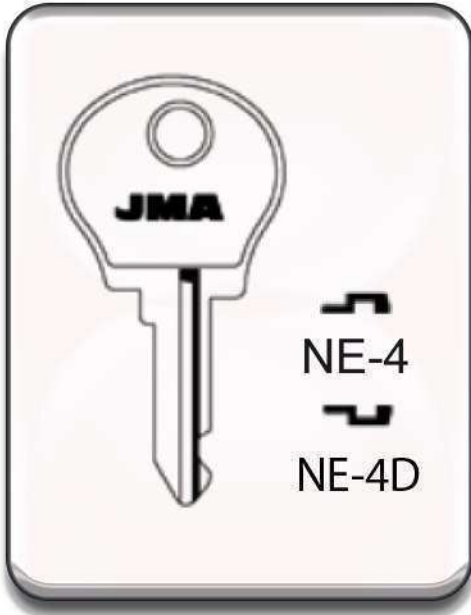



NE-36.P1



NE-42.P

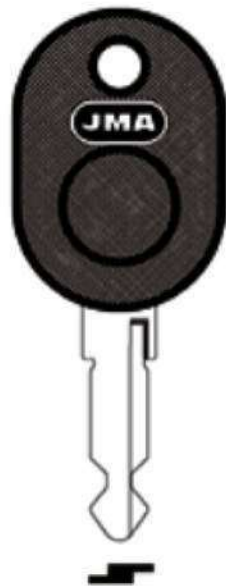

NE-42.P1



NE-50.P



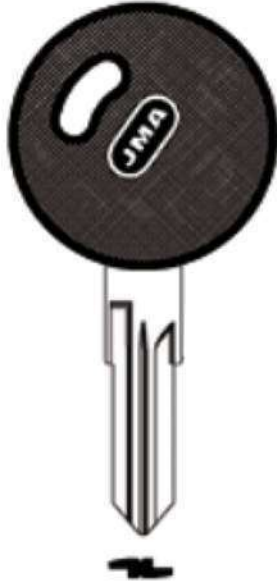

VA-34.P1



CHR-3



CHR-3.P



NE-11.P1



NE-35.P



NE-52.P



**SKODA**



**SEAT**



**SKO-5.P**

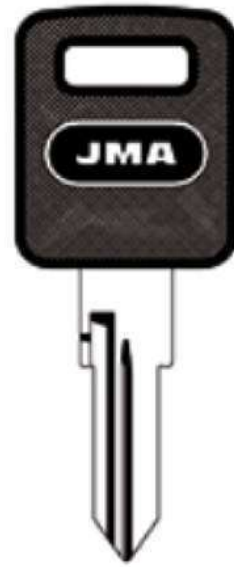

**CL-6.P**





  
MAR-1.P



  
SUZU-7

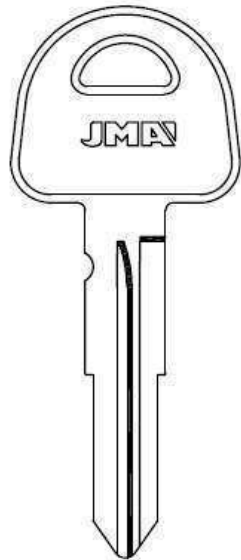
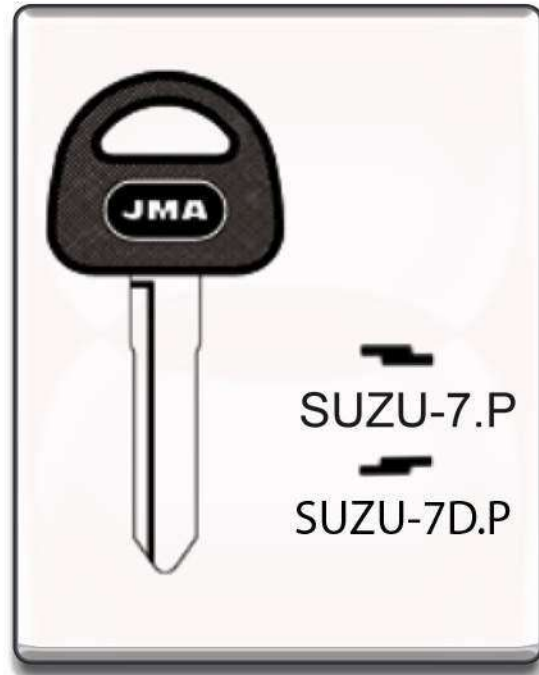

   
SUZU-8 SUZU-8I



   
SUZU-8.P SUZU-8I.P



SUZU-9.P

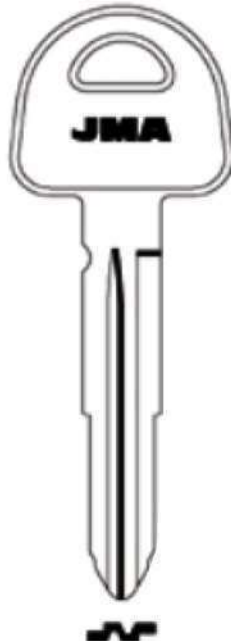

SUZU-10



SUZU-10.P

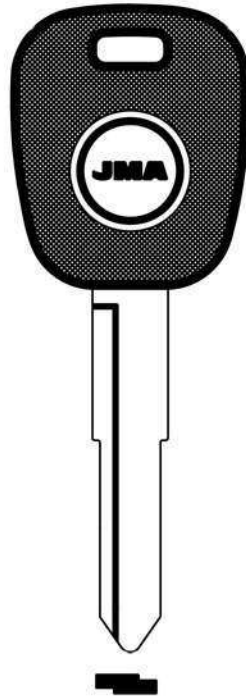

SUZU-14.P2

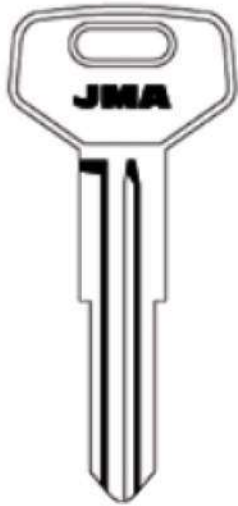

  
TOYO-8

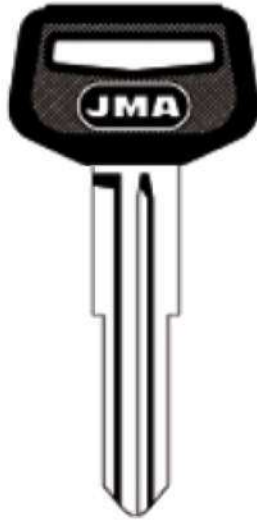

  
TOYO-8.P

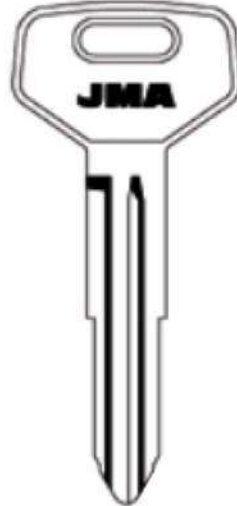

  
TOYO-9



  
TOYO-9.P1

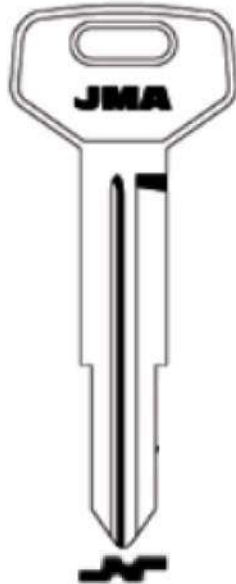

  
TOYO-10

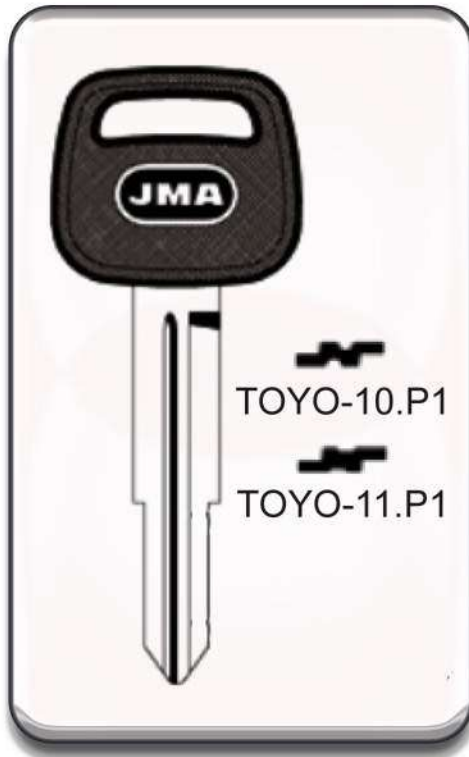

  
TOYO-10.P1  
  
TOYO-11.P1

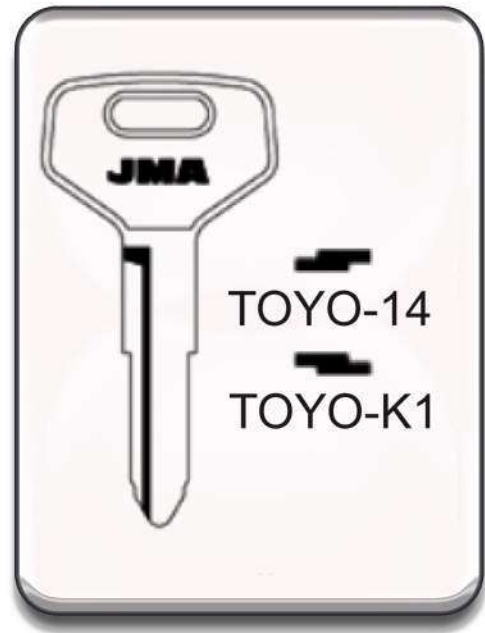

  
TOYO-14  
  
TOYO-K1





TOYO-14P

TOYO-K1P



TOYO-15



TOYO-15.P

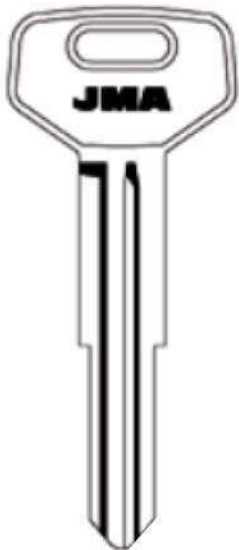

TOYO-16



TOYO-16.P1



TOYO-17



TOYO-17.P

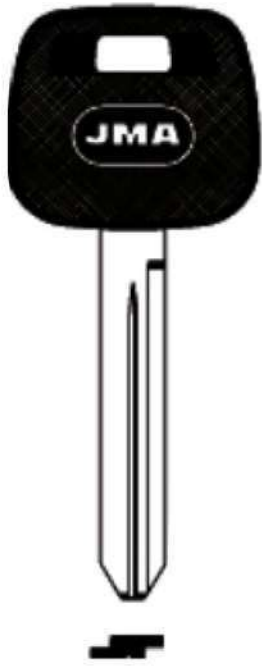

TOYO-19.P



TOYO-23.P



GM-24.P



AU-HV.P1



VO-FH.P



VO-VB.P

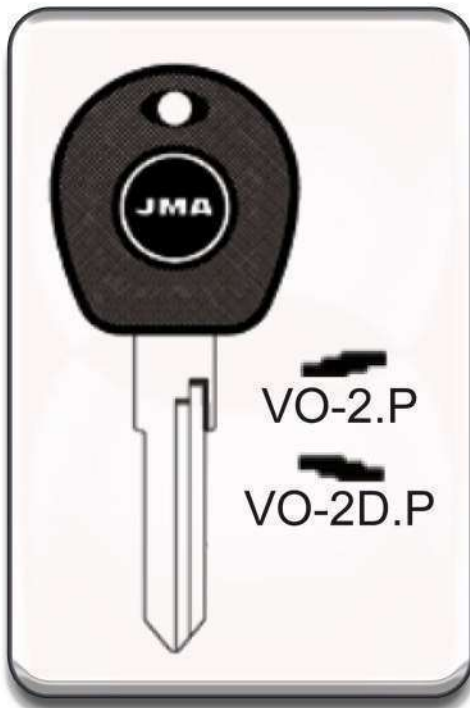

VO-2.P  
VO-2D.P

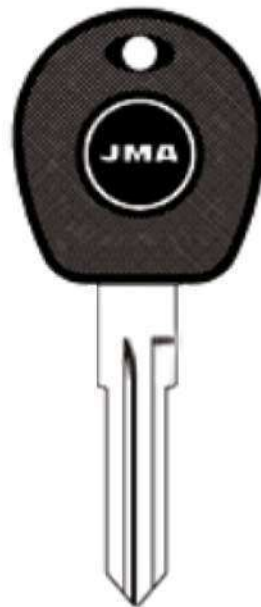

VO-8.P



CLI-1D





  
NE-12.P



  
HU-DF.P

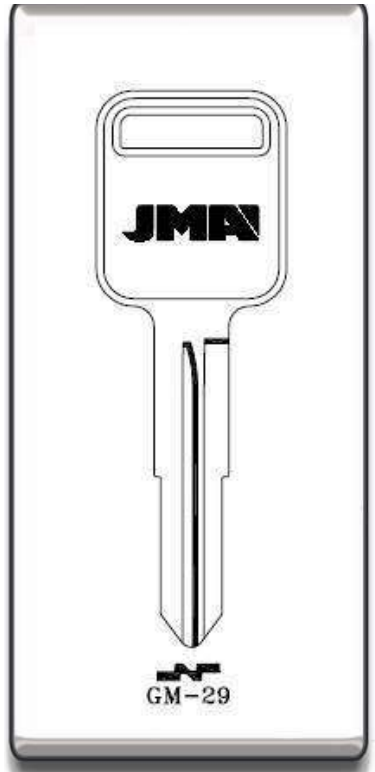
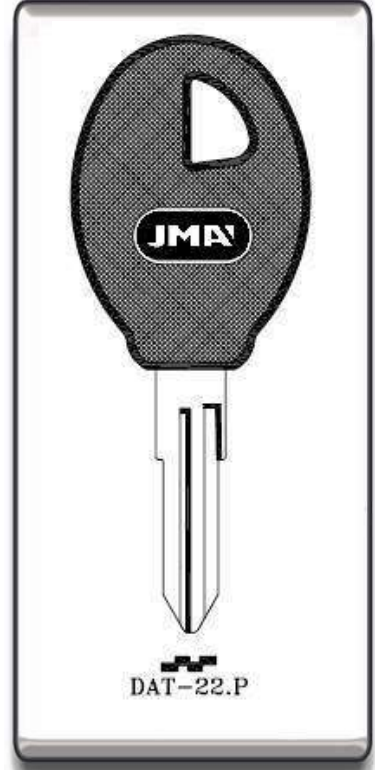
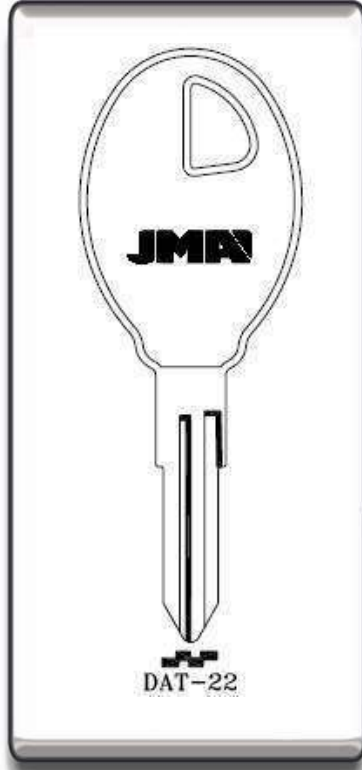
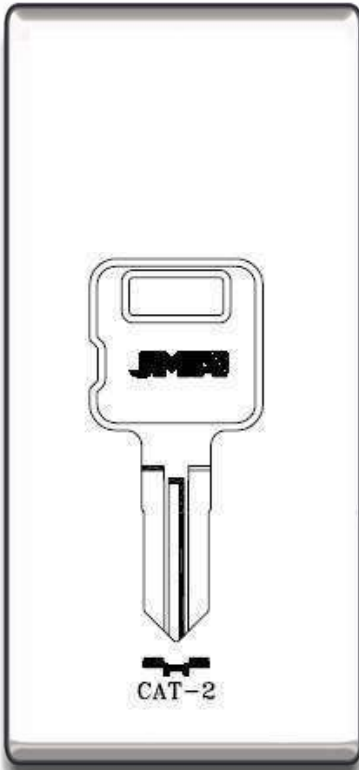



GM-30.P



GM-35.P

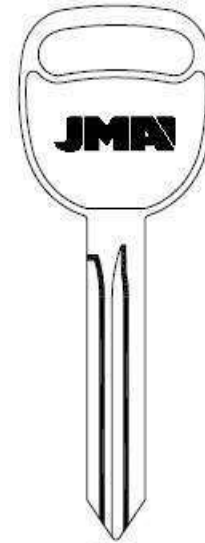

GM-37



GM-37.P



GM-38.P



GM-40.P



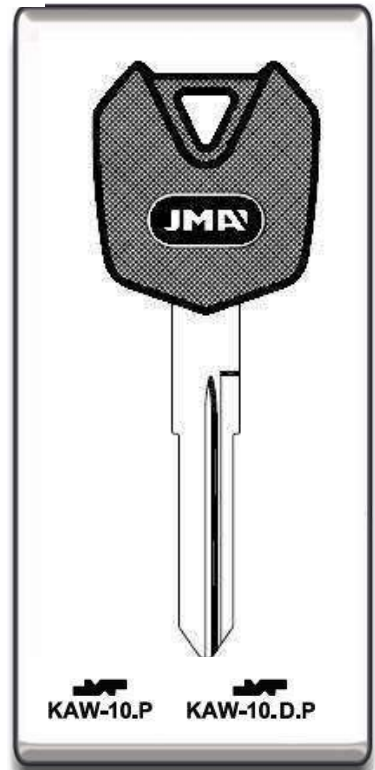
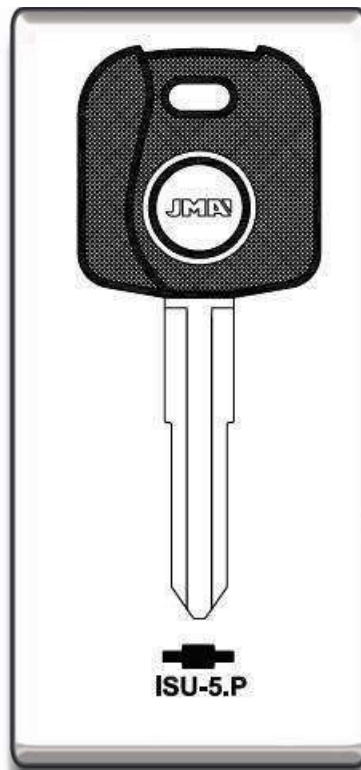
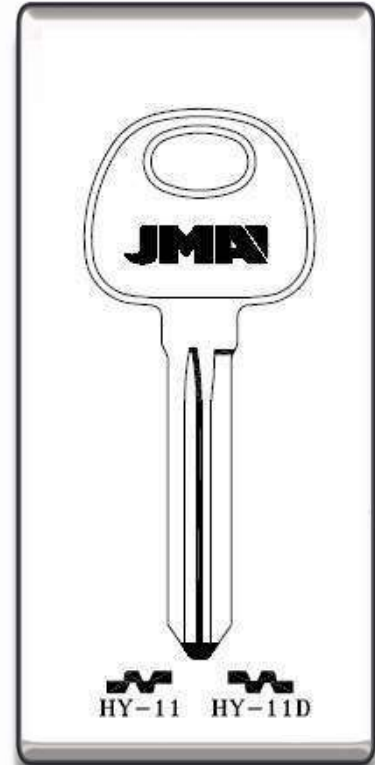
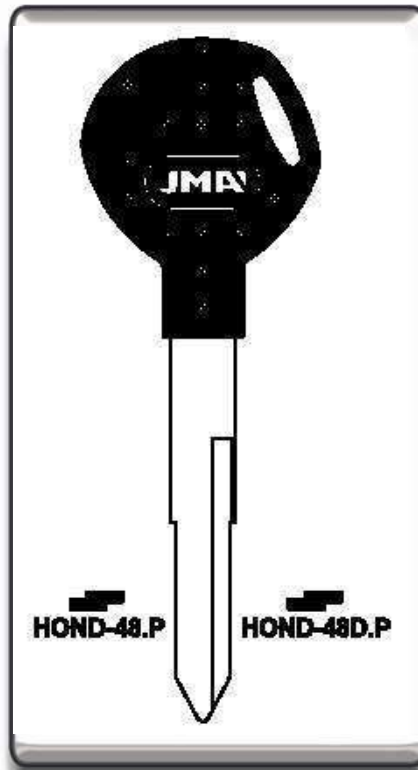

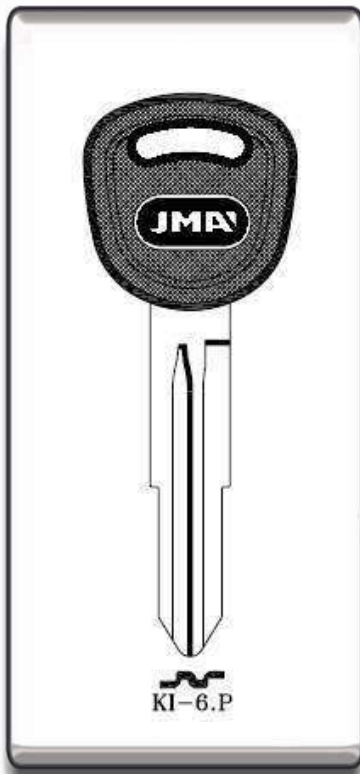
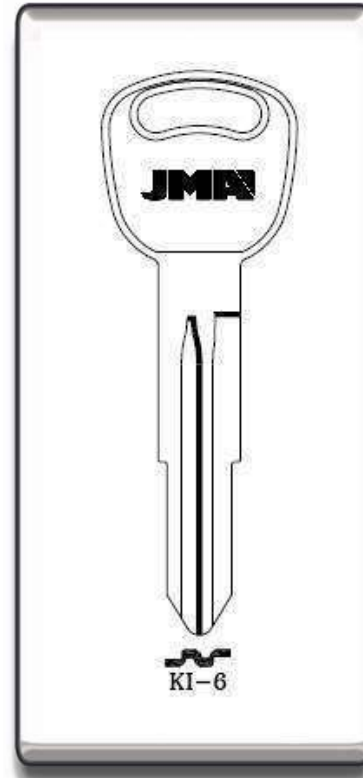
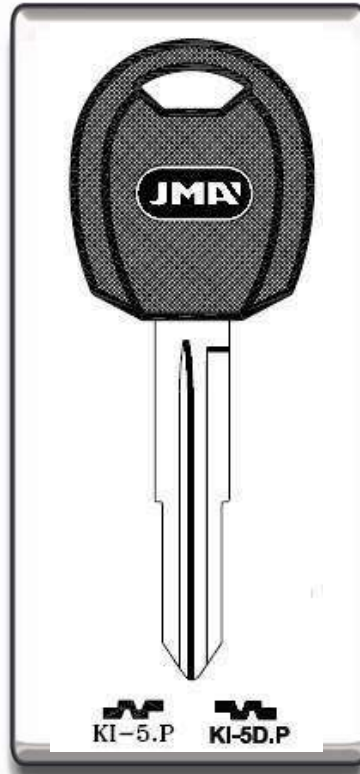

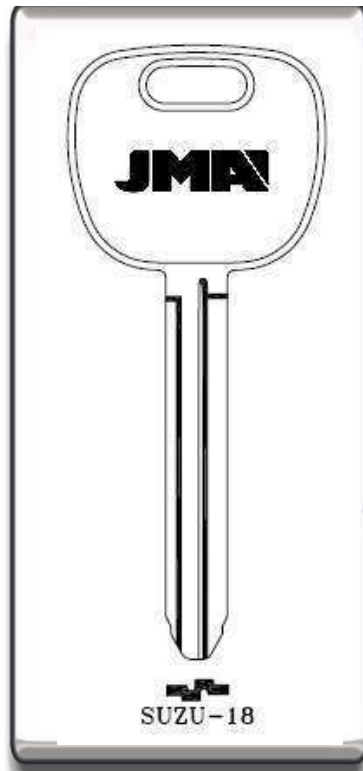
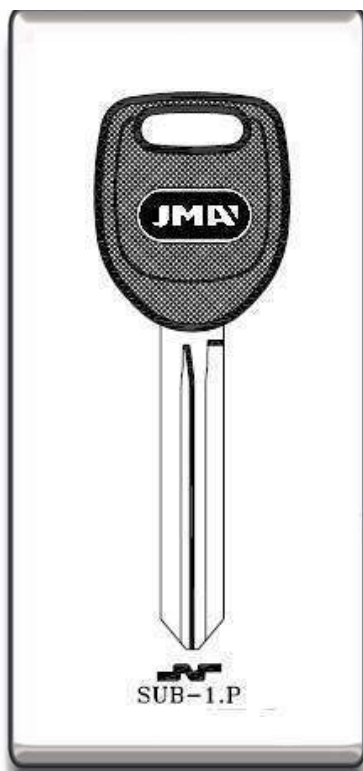
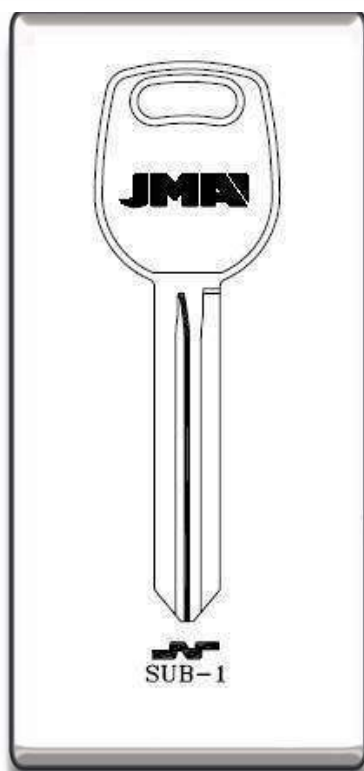
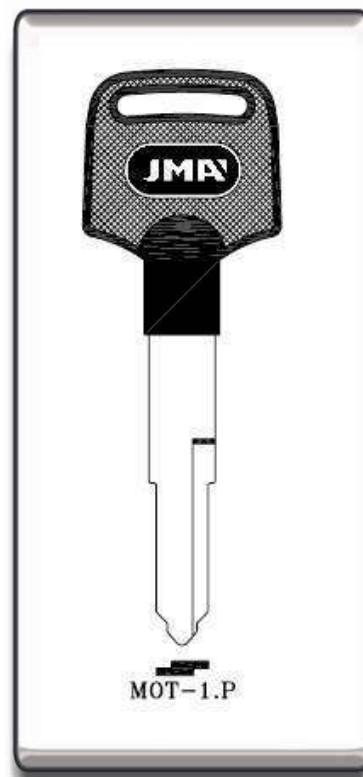
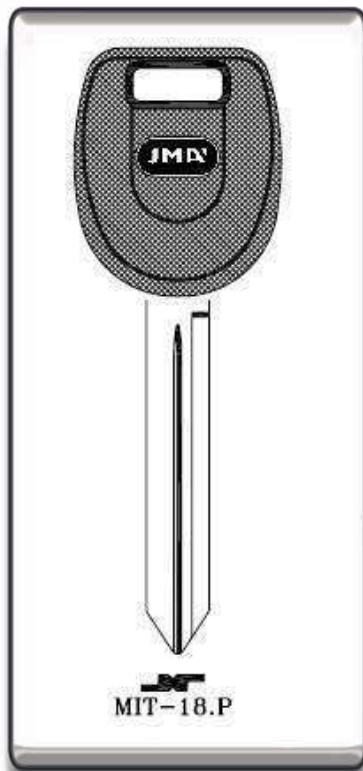





**SUZU-18.P**



**SUZU-19D.P**



**SSA-1.P1**



**BMW**



**BAJAJ**

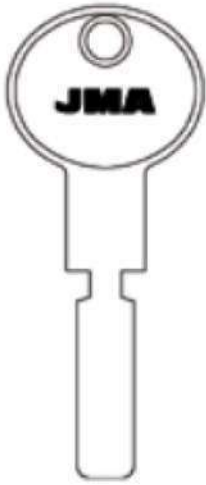

**BM-4**

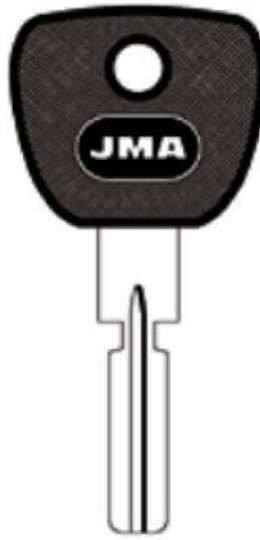

**BM-5.P**



**BM-6.P**

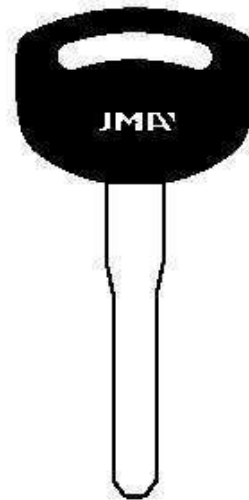

**BAJ-3.P**



CITROEN



FIAT



SIX-3.P

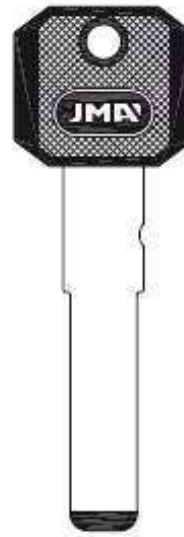

FI-16.P1







FORD



G. MOTORS



FO-6.P



OP-WY.P

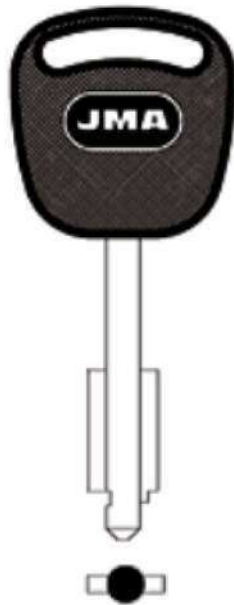

FO-22.P



OP-WH.P



HY-19.P3 HY-19D.P3



HY-18.P3



SAA-1.P1



**HONDA**



**TOYOTA**



HOND-17.P



TOYO-18.P



HOND-31.P







**JAGUAR**



**SCANIA**



JAU-1.P



HU-2.P



**BCN**  
Maquinaria e insumos de ferragem



**MERCEDES  
BENZ**

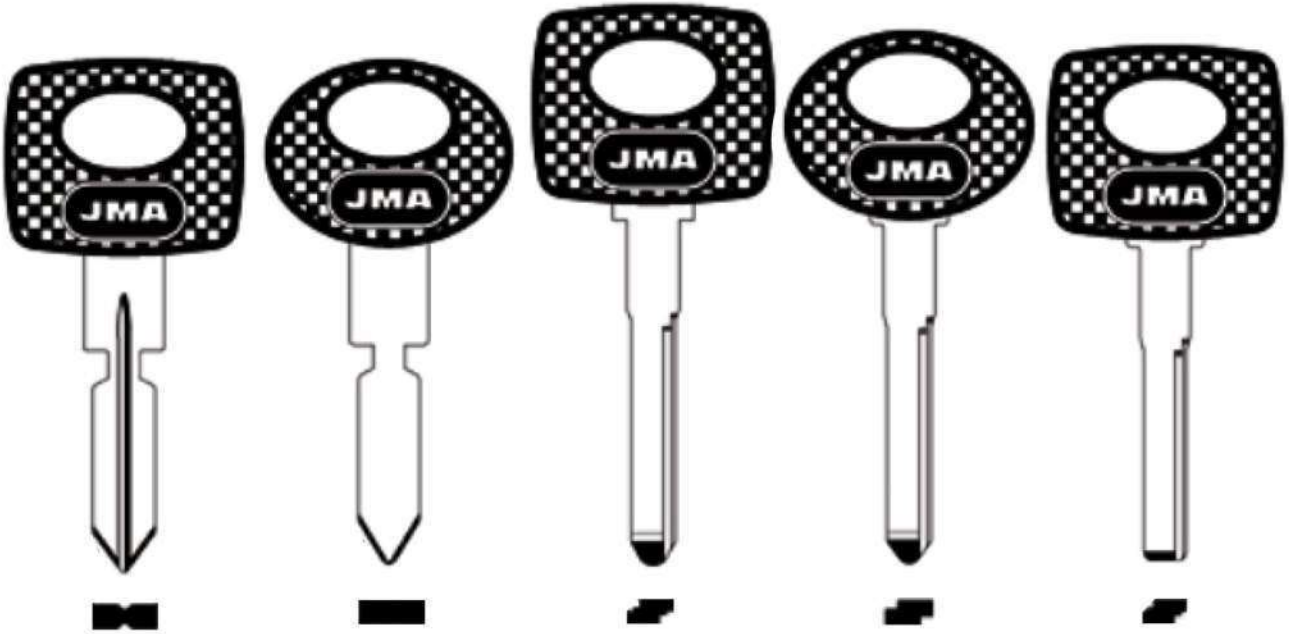

ME-2.P

ME-3.P

ME-4.P

ME-6.P

ME-7.P

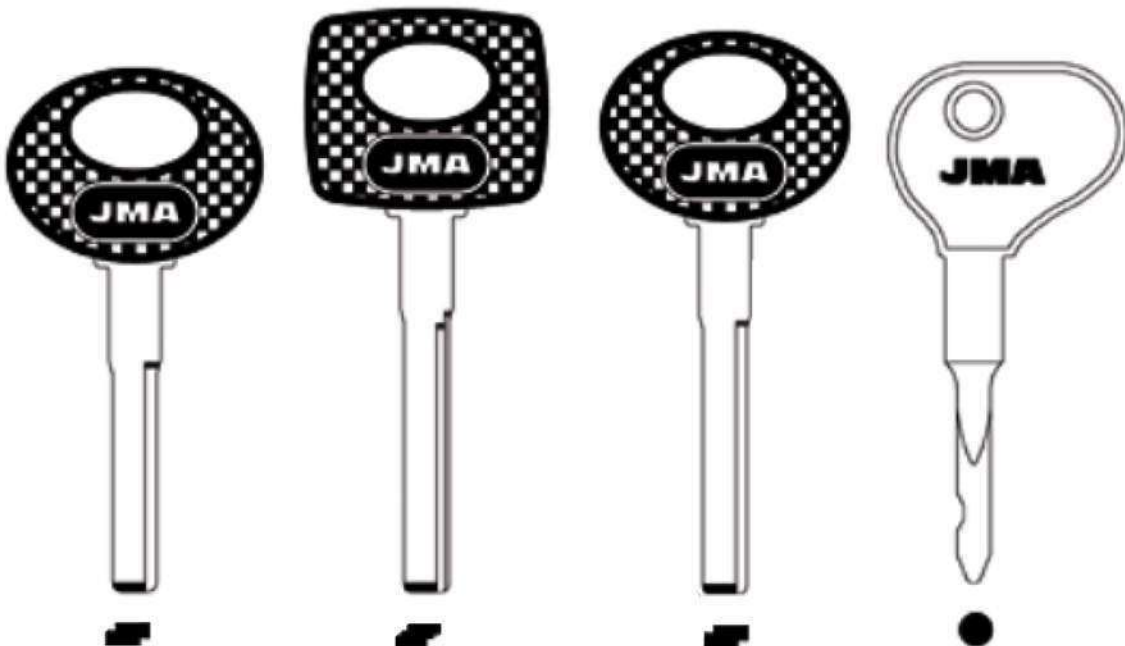

ME-8.P

ME-10.P

ME-12.P

BH-2

www.bcnllaves.cl



PEUGEOT



VOLVO



NE-34.P



NE-51.P2



HU-DH.P



HU-DN.P



SIX-3.P1



NE-40.P





**SUBARU**



**VOLKSWAGEN**



SUB-2.P



HU-HAA.P1

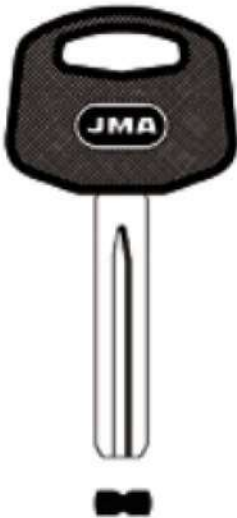

ABU-29.P

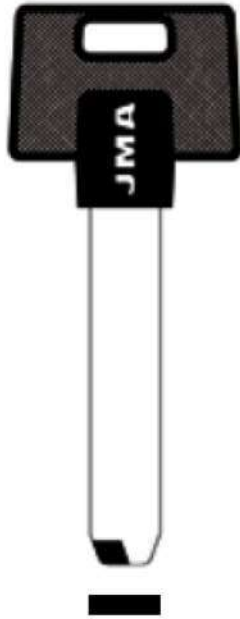

MUL-T2.P

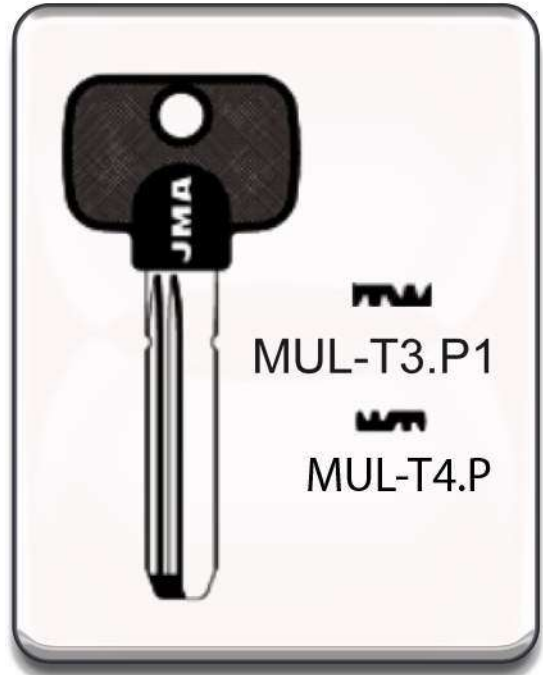

MUL-T3.P1

MUL-T4.P



UCCEM-8D.P



MT-EG.P



ABL-1



ABL-2

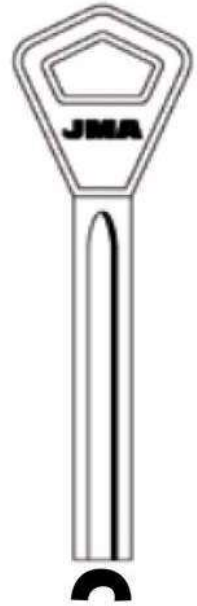
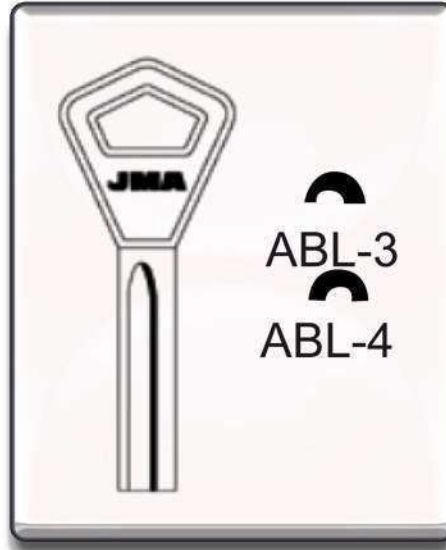

ABL-5

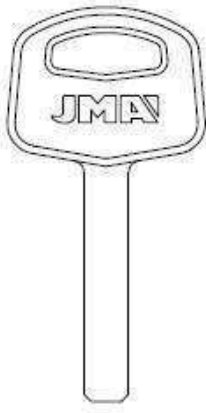

ABU-3



ABU-34

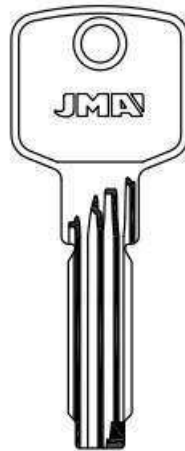

ABU-81

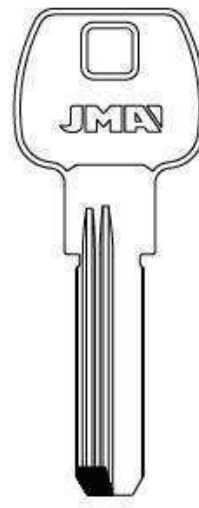

AKI-1D



ASH-7D



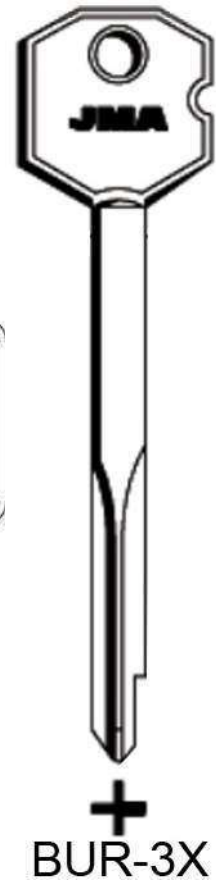
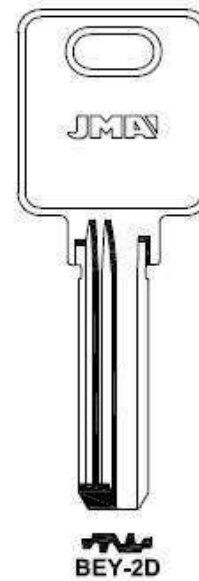
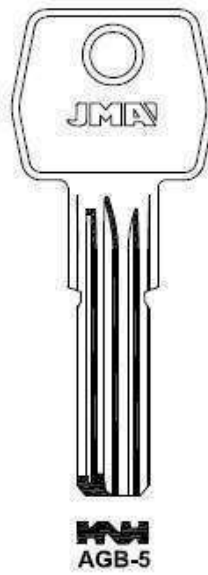
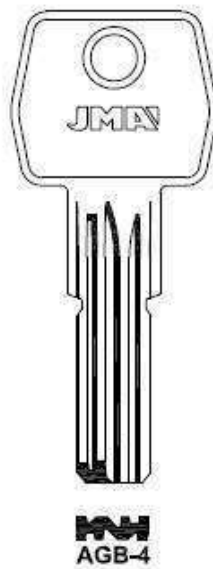
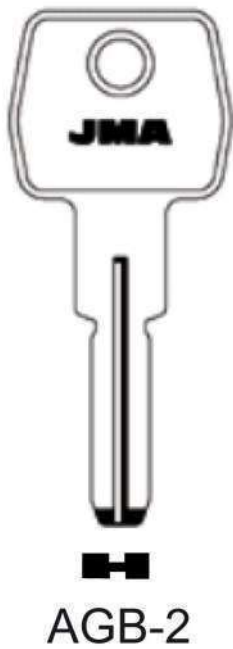
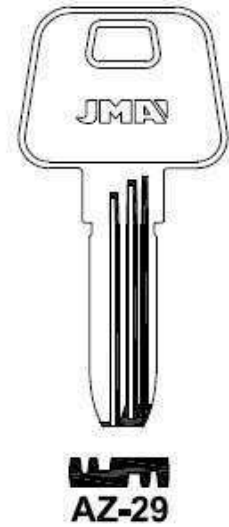
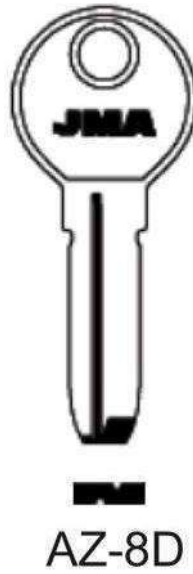
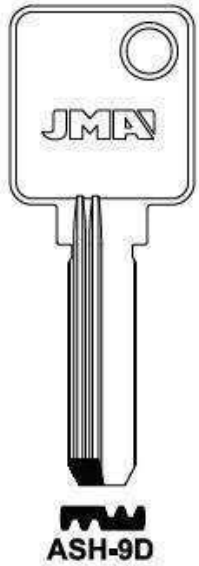



CVL-9D

+  
FM-2X-  
KA-5-  
KA-7-  
KA-8

LIN-19

LIN-19D



MCM-2G



MCM-3G

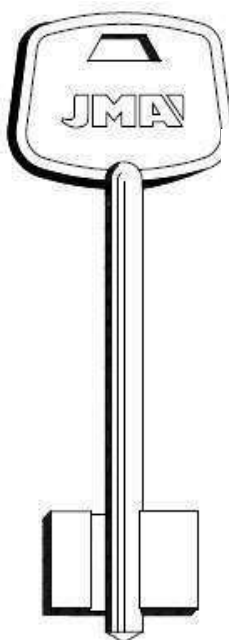

MCM-5G



MCM-10

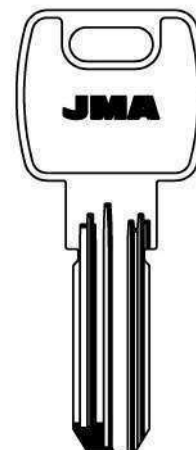

MCM-16E8



**X**  
PAP-1X



**X**  
PAP-2X

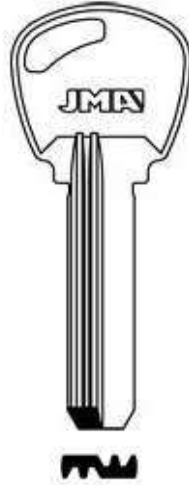

PLI-3D



STS-38



STS-X6

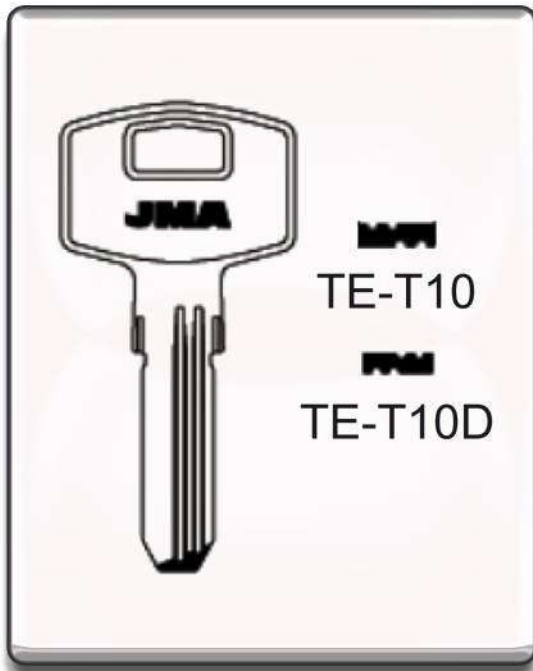

TE-T60



TE-T62



TE-T80



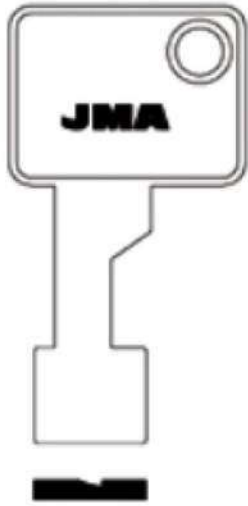

TOV-1

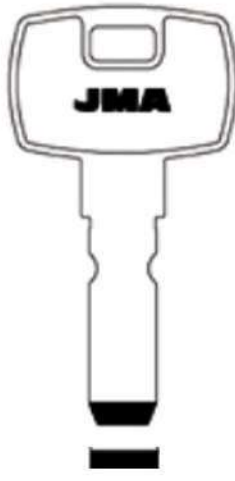

TOV-4



TOV-5

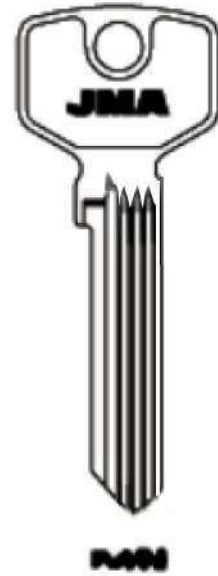

TV-19D



UCEM-13D



U-1X

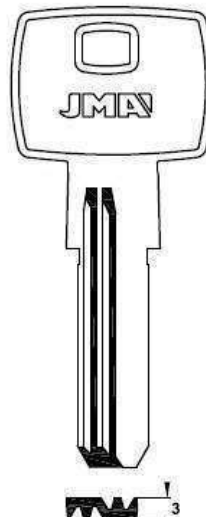

YA-280D



YAR-1



# LLAVES TUBULARES



# LLAVE ESPOSA

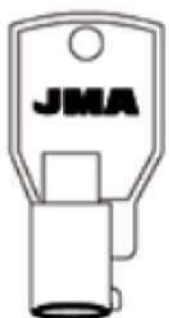

AGA-1T



AGA-2T



74G



P40  
OD-1



P50  
OD-2



P60  
OD-3



P70  
OD-4



K400  
OD-5D

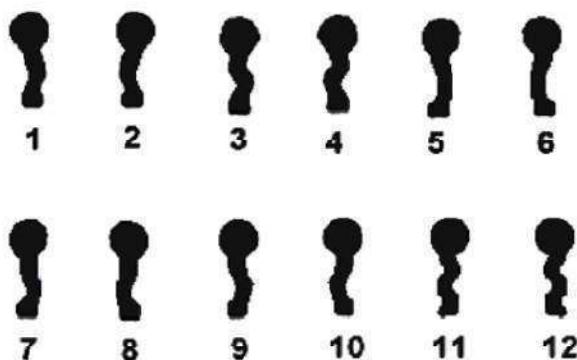

LLAVES DE LETRAS





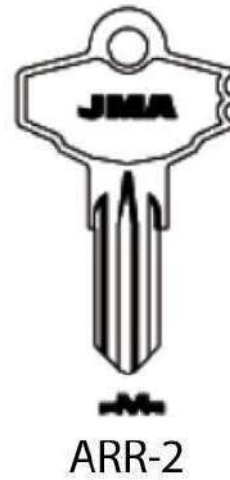
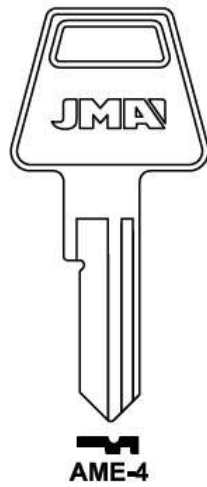
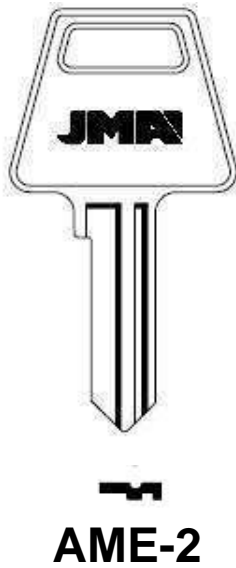
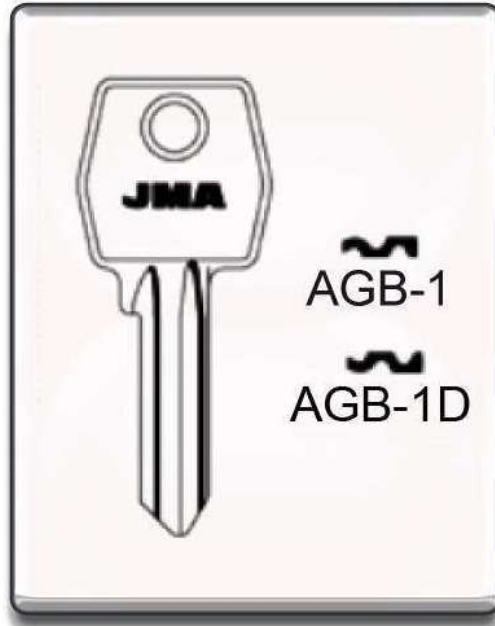
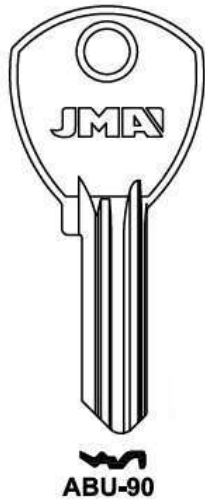



AZ-18 AZ-18D

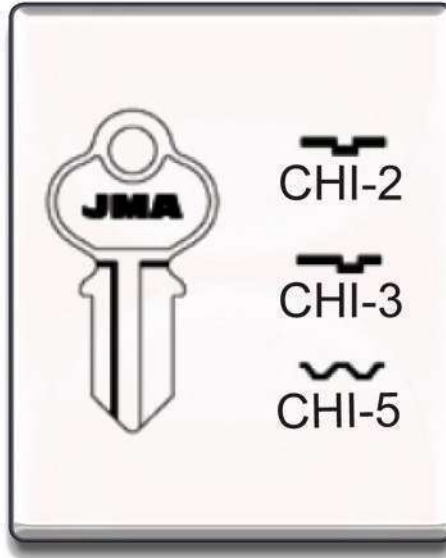

CHI-6



CIS-2



CIS-4



CVL-5I CVL-5D



DOM-11/DOM-11D



DOM-13D



DOM-26D



EU-1



FAM-2

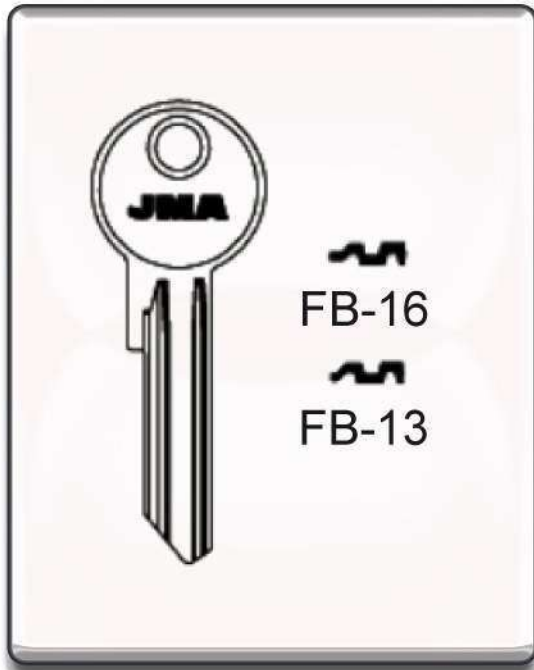

FB-16  
FB-13

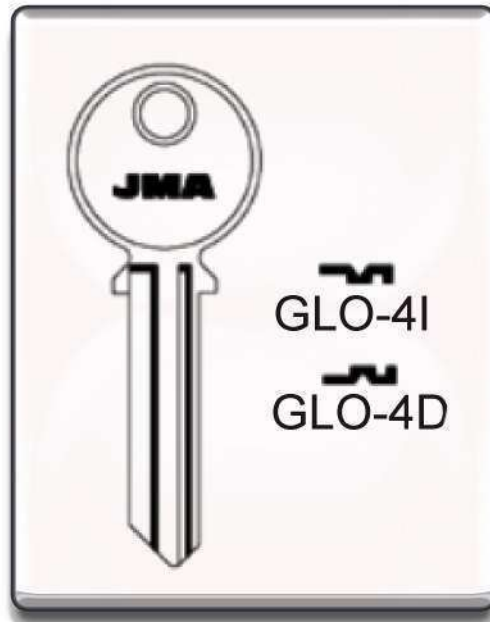

GLO-4I  
GLO-4D



HAG-1D





HAF-1D



HAF-2D



IS-15



JGH-1D



KWI-10D

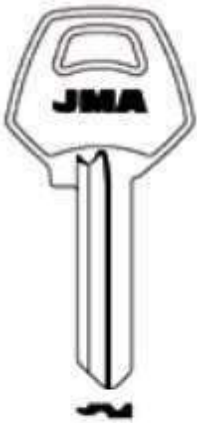

LAF-1D

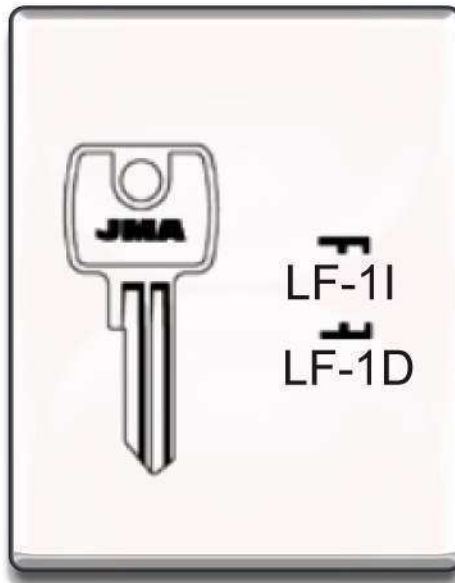

LF-11  
LF-1D



LF-2

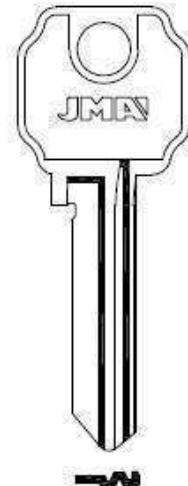

LIN-16D

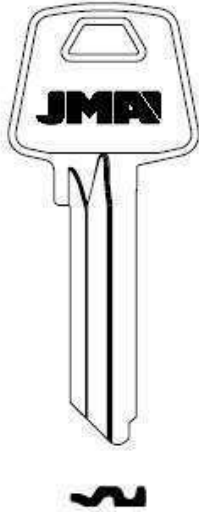

**MCM-12D**

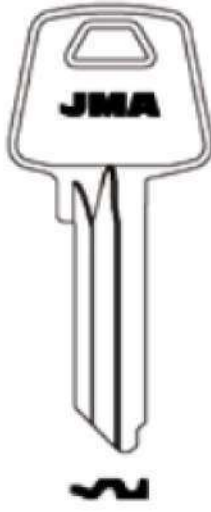

**MCM-13D**



**MER-1D**



**MER-16D**



**OJ-10**

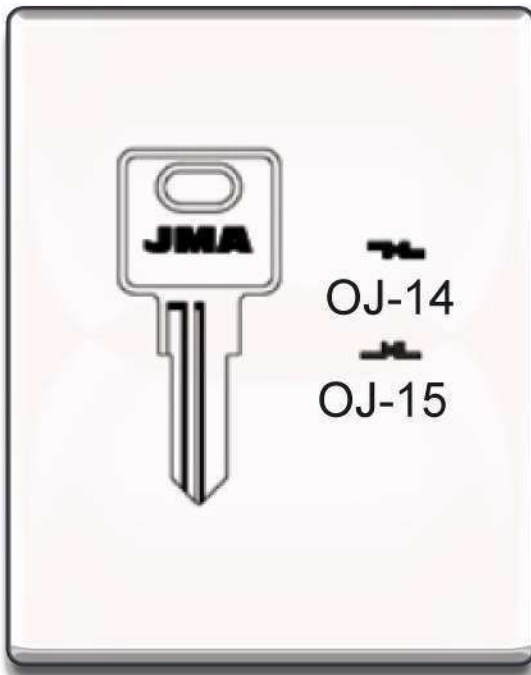

**OJ-14**

**OJ-15**



**OJ-18.P**

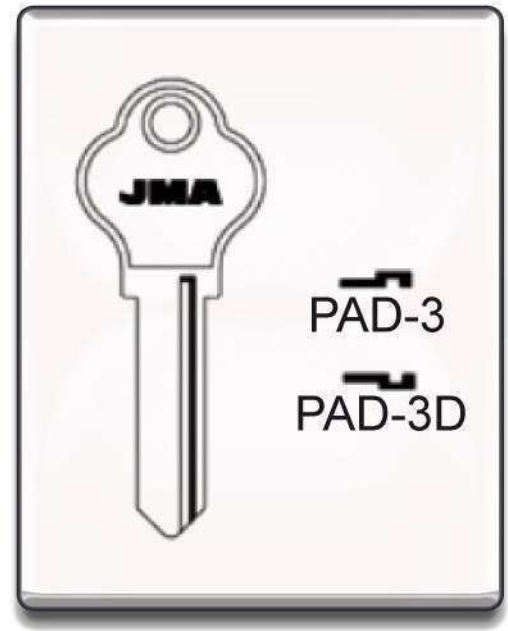

**PAD-3**

**PAD-3D**



PAP-1

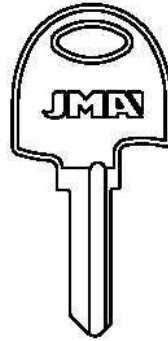

PAP-15D



PR-15D

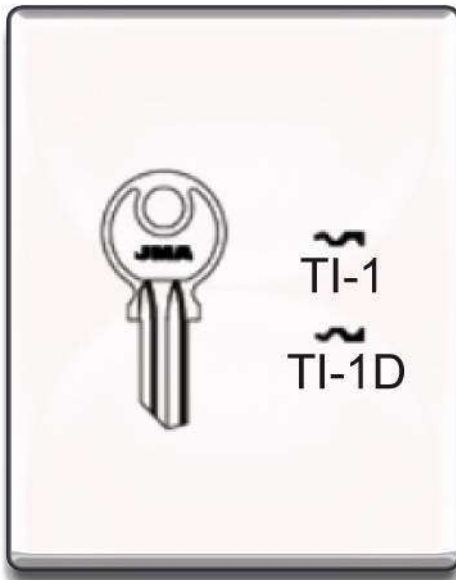

TI-1  
TI-1D



U-5D



WES-1D



**ANV-1D**

Cod. Flood

**5D****ANV-2**

Cod. Flood

**4G****ANV-3D**

Cod. Flood

**4H****ANV-4D**

Cod. Flood

**5B****ANV-5**

Cod. Flood

**5C****ANV-6D**

Cod. Flood

**5DI****BRS-2**

Cod. Flood

**14H****COR-62**

Cod. Flood

**6****DIM-1D**

Cod. Flood

**19B****EVE-7**

Cod. Flood

**5R**

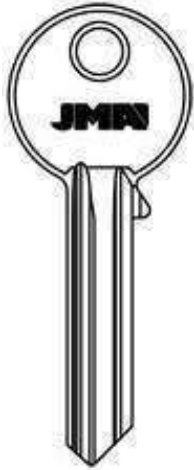
**FLD-1D**

Cod. Flood

**2****FLD-2D**

Cod. Flood

**6B****FLD-3**

Cod. Flood

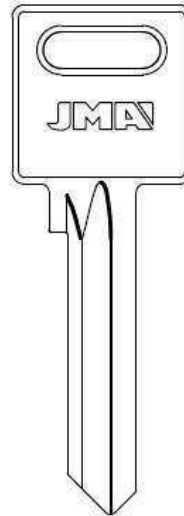
**5Z****FTE-1DE**

Cod. Flood

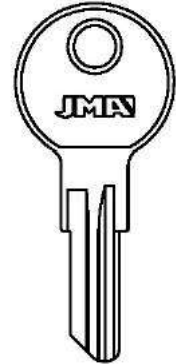
**20F****GAS-2**

Cod. Flood

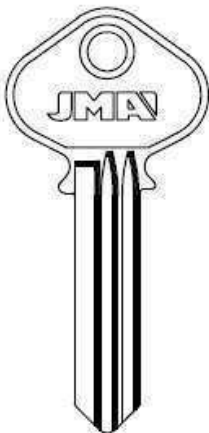
**5G****GB-7**

Cod. Flood

**GLD-1**

Cod. Flood

**1G****GLO-17**

Cod. Flood

**6L****GLO-17D****GB-2****GLO-19****GB-4****GLO-19D****GB-3**



**KW-2**

Cod. Flood

**7AI**



**KWI-1K**

Cod. Flood

**7A**



**LIO-1**

Cod. Flood

**H**



**NCE-1D**

Cod. Flood

**6N**

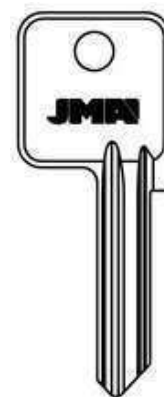

**OD-6D**

Cod. Flood

**6H**



**OD-7D**

Cod. Flood

**6I**



**OD-8D**

Cod. Flood

**6J**



**OD-9D**

Cod. Flood

**G**

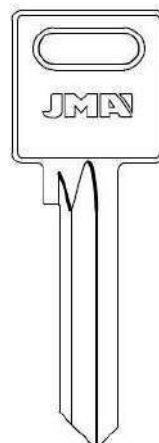

**OD-10D**

Cod. Flood

**20**

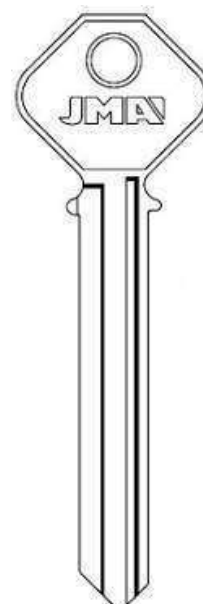

**PH-55L**

Cod. Flood

**7PL**

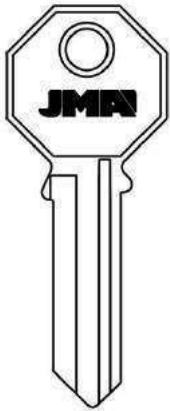

**PHI-52**

Cod. Flood

**7P****PLI-1D**

Cod. Flood

**1D****PLI-2D**

Cod. Flood

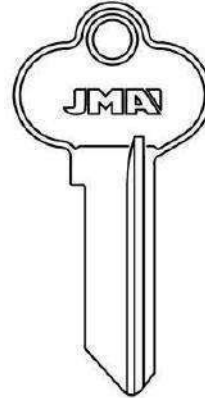
**1PX****SCA-1**

Cod. Flood

**1S****SCA-2D**

Cod. Flood

**1A****SCA-3D**

Cod. Flood

**1SI****SCA-4D**

Cod. Flood

**1AX****SCA-5**

Cod. Flood

**1SX****SLG-1**

Cod. Flood

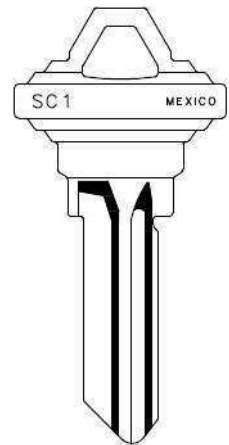
**22****SLG-3E**

Cod. Flood

**11A**

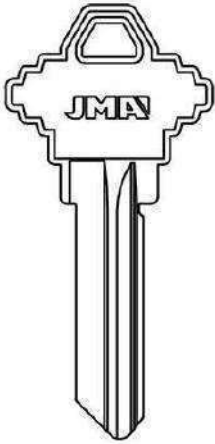

**SLG-4E**

Cod. Flood

**11B**

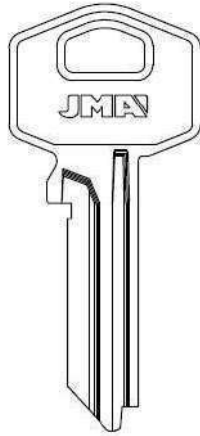

**TE-8I**

Cod. Flood

**2T**



**TRI-5D**

Cod. Flood

**5T**



**TRI-5I**

Cod. Flood

**5S**

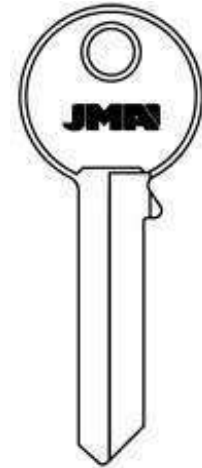

**TRI-23**

Cod. Flood

**2B**

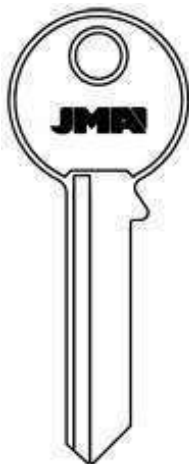

**TRI-23D**

Cod. Flood

**2A**

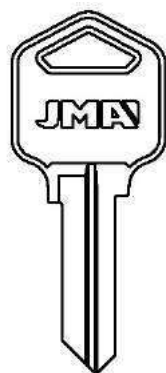

**TRU-3D**

Cod. Flood



**TX-5D**

Cod. Flood

**5F**



**TX-7**

Cod. Flood

**15H1**



**TX-7D**

Cod. Flood

**15H2**

**TX-8**

Cod. Flood

**14H1****TX-8D**

Cod. Flood

**14H2****TX-9**

Cod. Flood

**4T****TX-9D**

Cod. Flood

**4R****TX-10**

Cod. Flood

**5M****U-5DD**

Cod. Flood

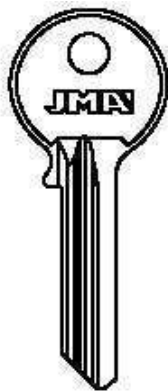
**1X****U-29D**

Cod. Flood

**9B****VI-11**

Cod. Flood

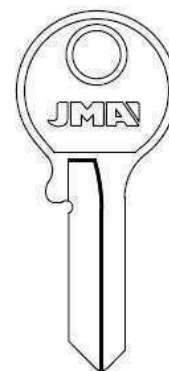
**18B****VI-2D**

Cod. Flood

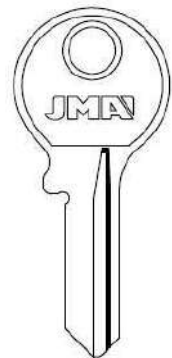
**VI-3****VI-2I**

Cod. Flood

**18A**

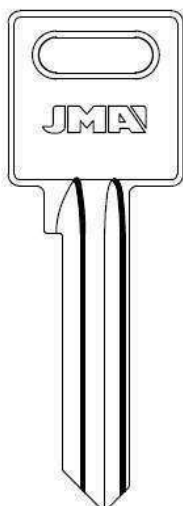

**YA-108**

Cod. Flood

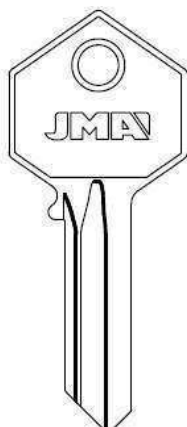
**30F****YA-1D**

Cod. Flood

**1****YA-24D**

Cod. Flood

**1****YA-24I**

Cod. Flood

**3****YA-25D**

Cod. Flood

**9****YA-25I**

Cod. Flood

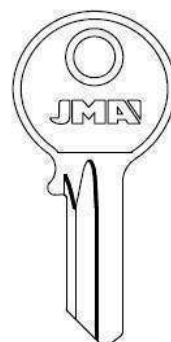
**10****YA-7D**

Cod. Flood

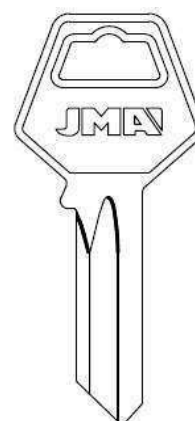
**9A****YA-77D**

Cod. Flood

**1P**

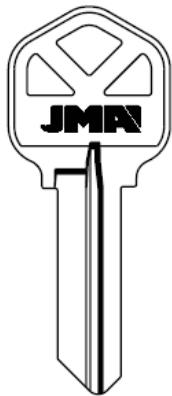

KWI-1



SCA-1



TE-81

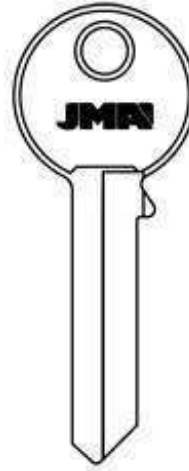

TRI-23

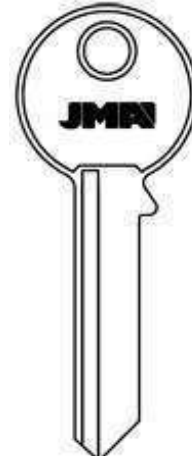

TRI-23D

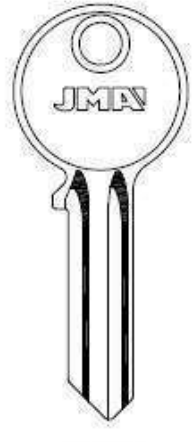

U-51

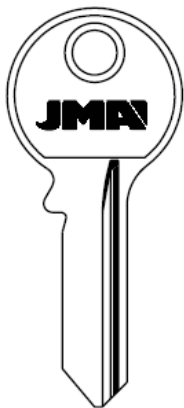

VI-1D

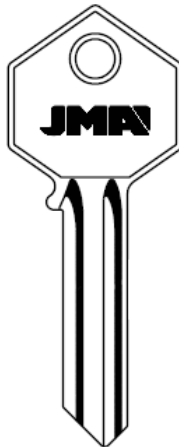

YA-22D

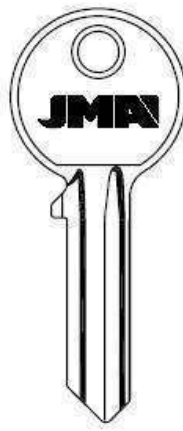

YA-24D

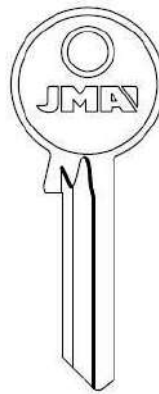

YA-25D

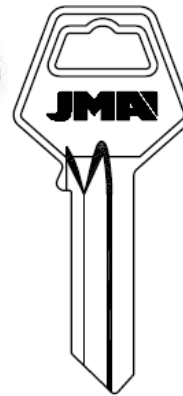

YA-77D

ALUMINIO COLOR

- AMARILLO
- AZUL
- AZUL MARINO
- LILA
- NARANJA
- NEGRO
- ROSADO
- ROJO
- VERDE OSCURO
- VERDE

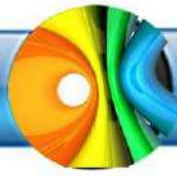

**PERFILES**

  
**KWI-1**  
Cod. Flood  
7-A

  
**SCA-1**  
Cod. Flood  
1-S

  
**YA-24D**  
Cod. Flood  
1



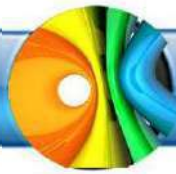

CT02

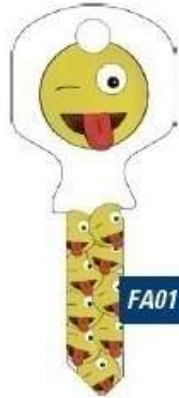

FA01



FA05

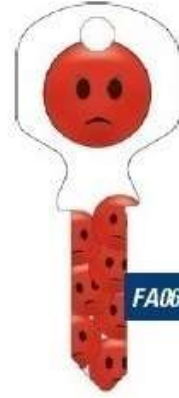

FA06

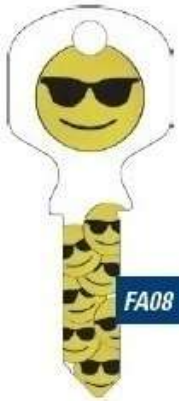

FA08



SV10



SV11



TE01



TE04



TE09



WL13



WL19

**PERFILES**

 **KWI-1**

Cad. Flood  
7-A

 **SCA-1**

Cad. Flood  
1-S

 **YA-24D**

Cad. Flood  
1

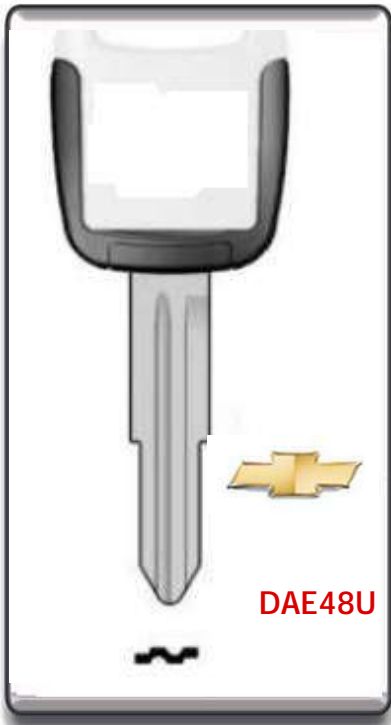

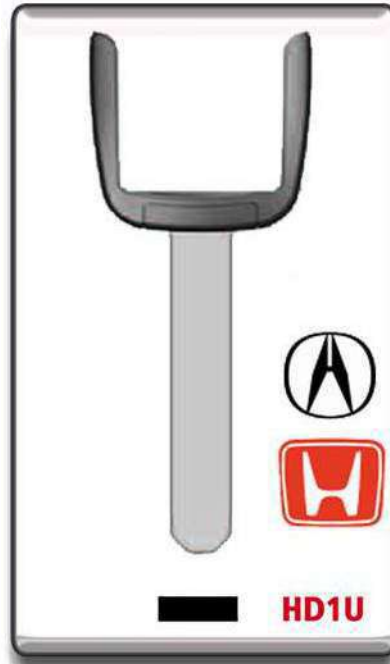



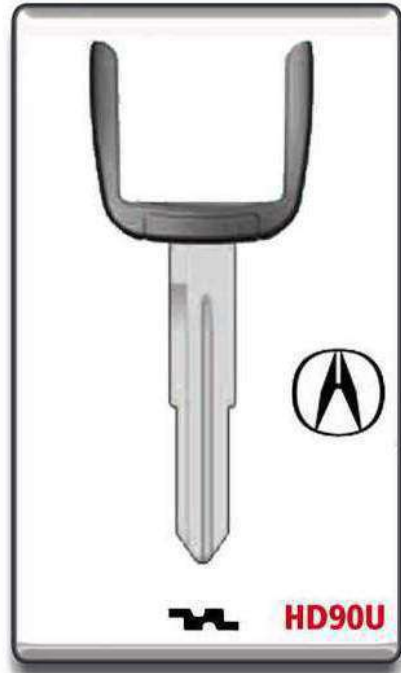



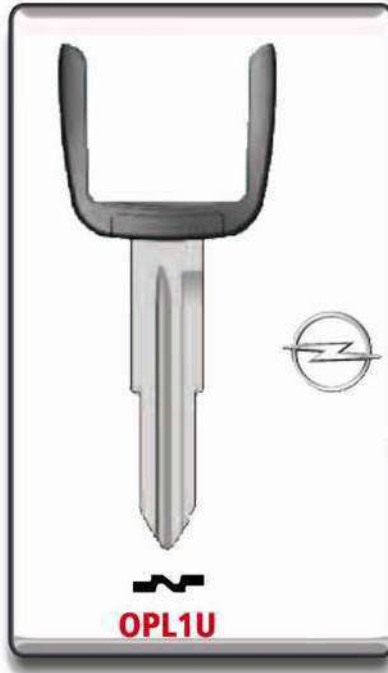



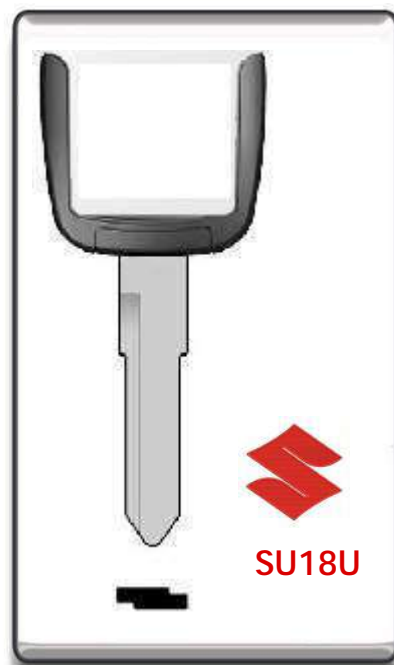
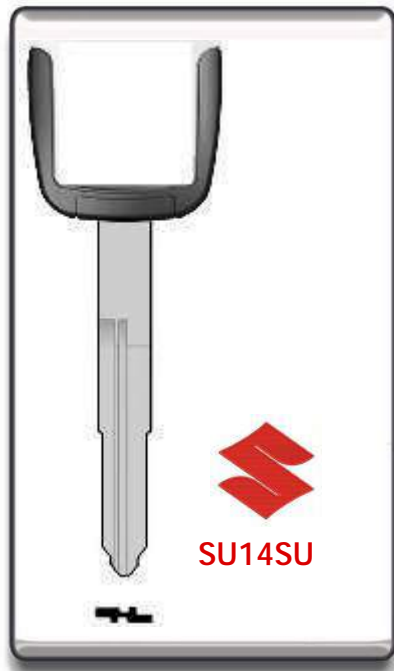



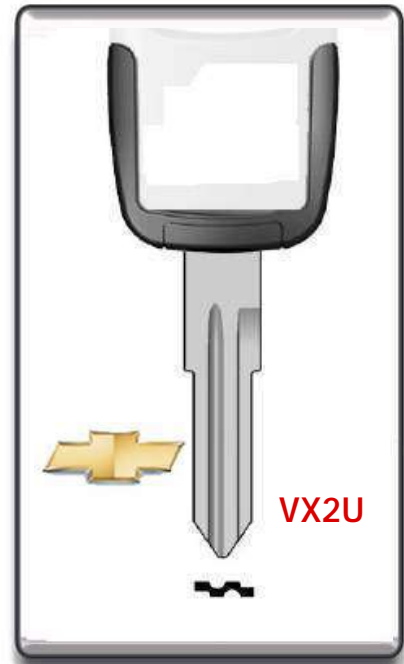



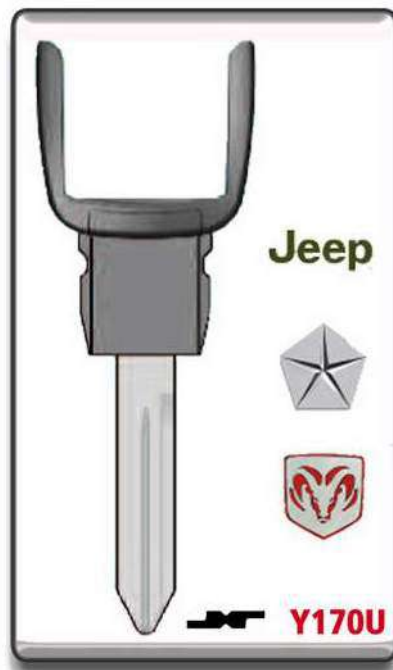
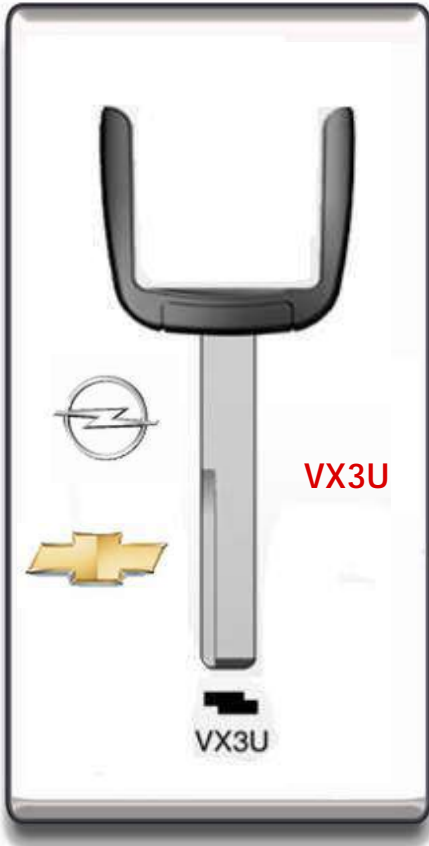

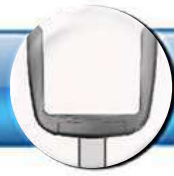

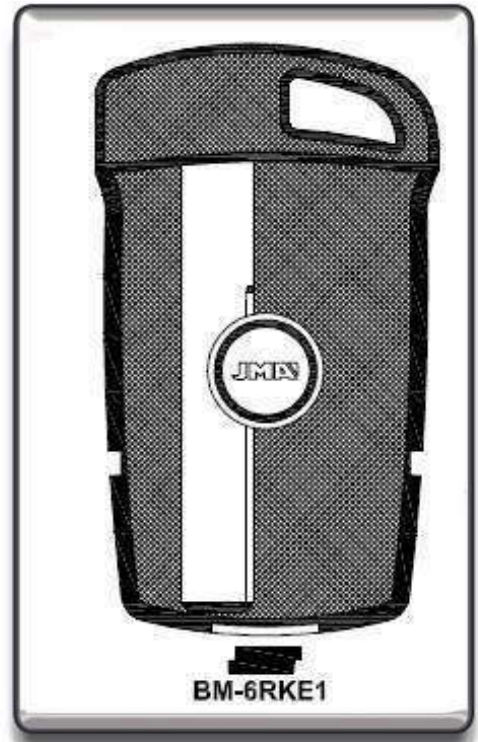
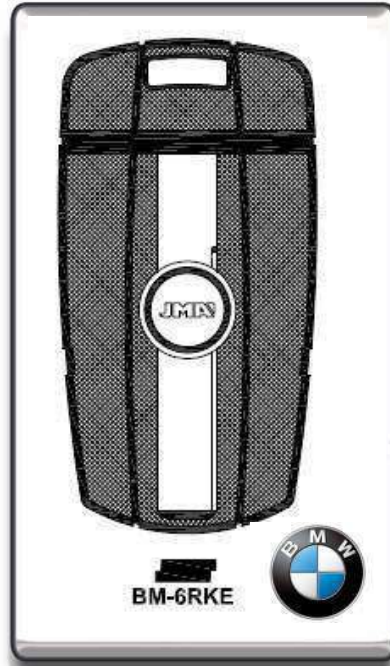
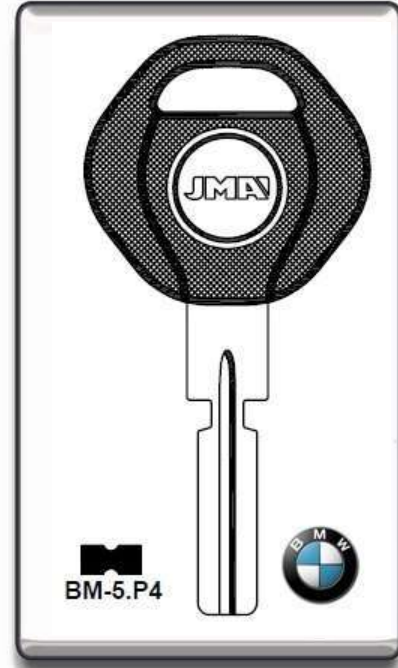
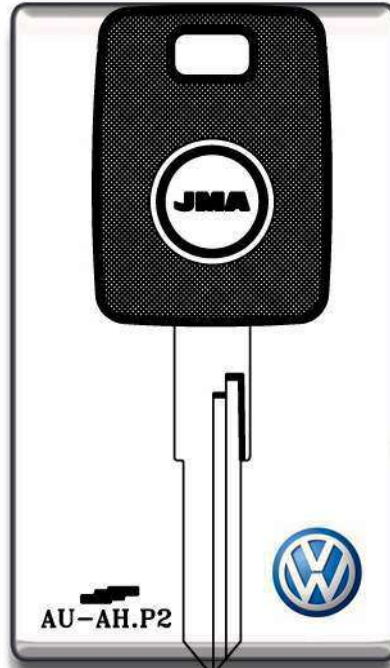



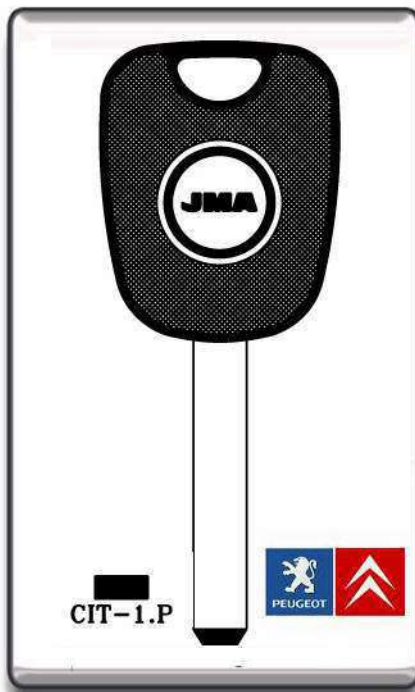
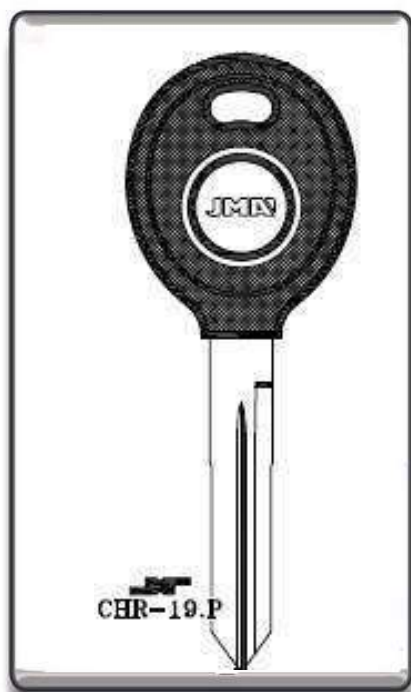
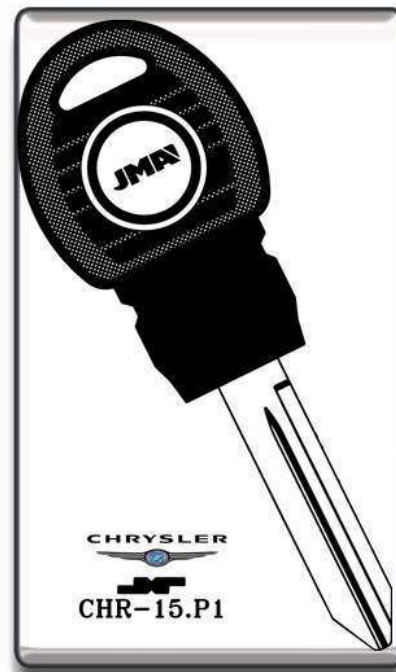

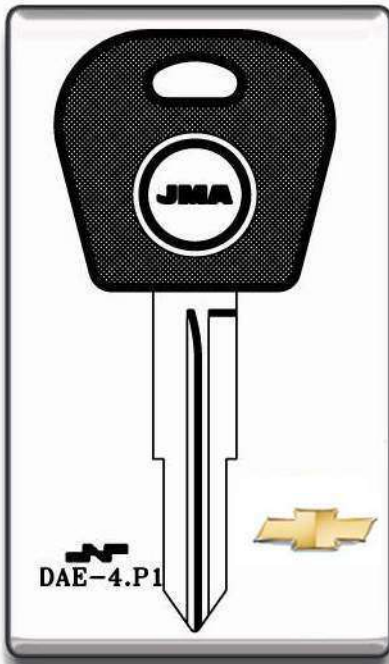
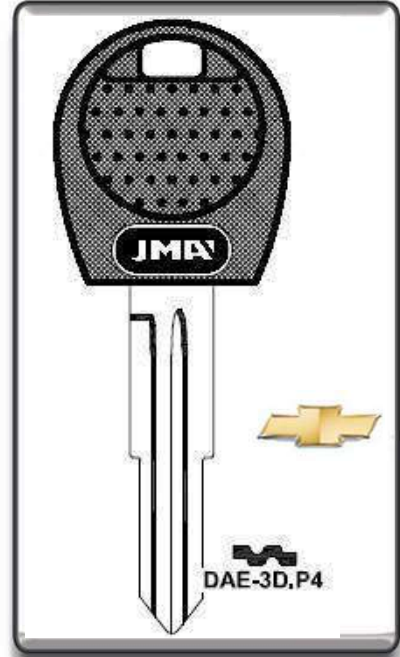
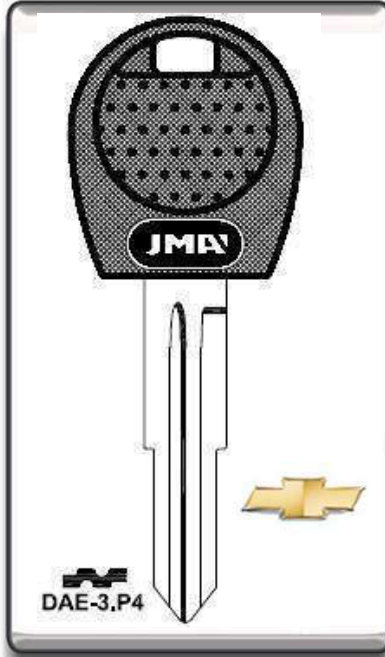



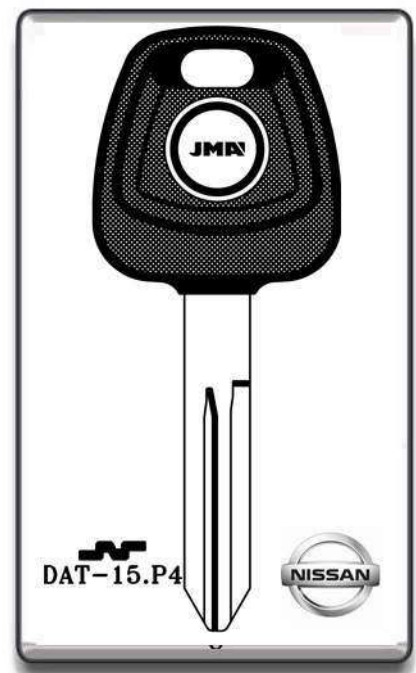
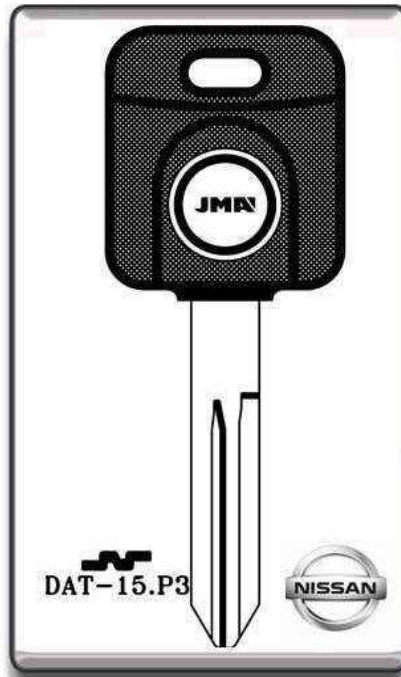
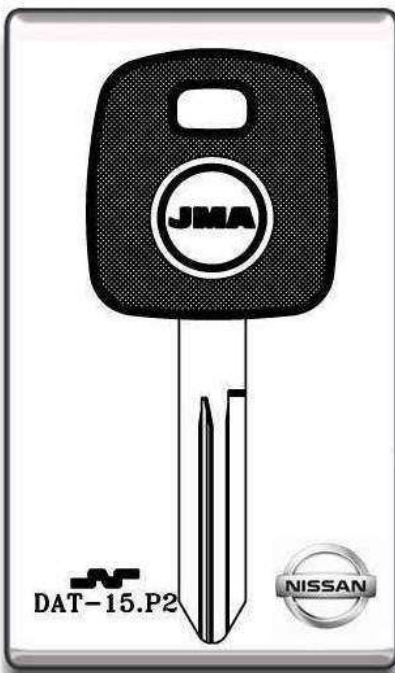
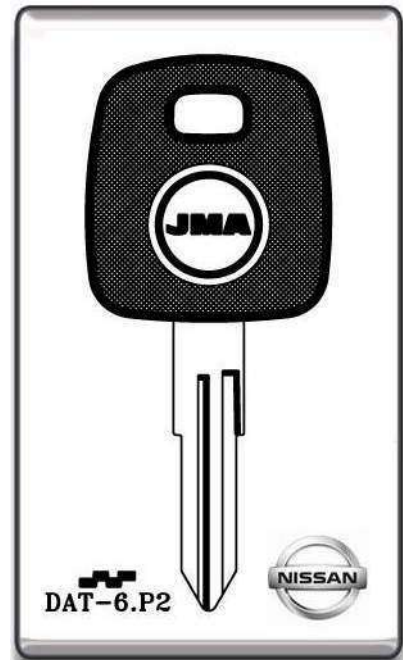
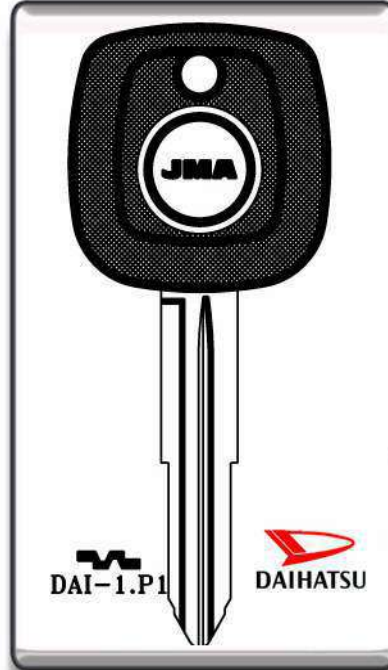



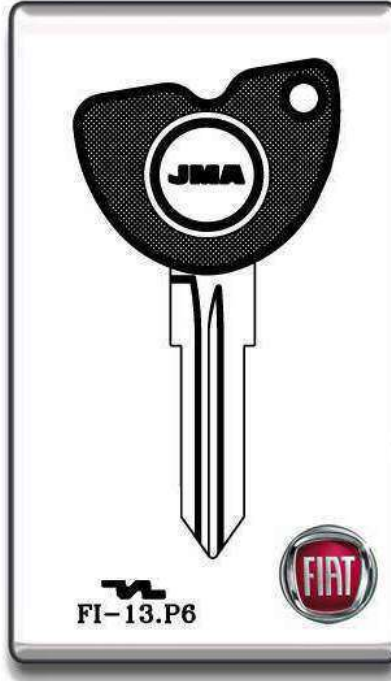
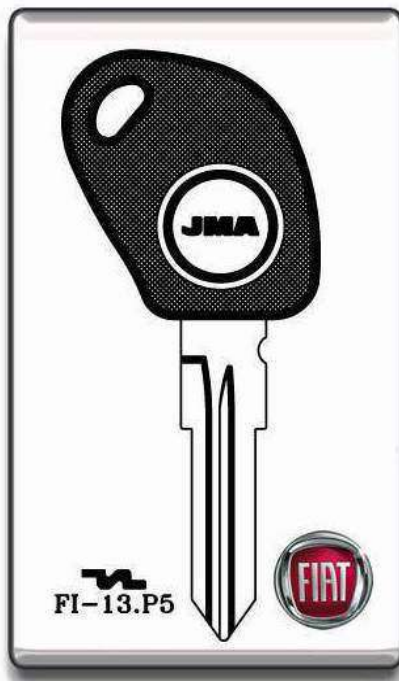
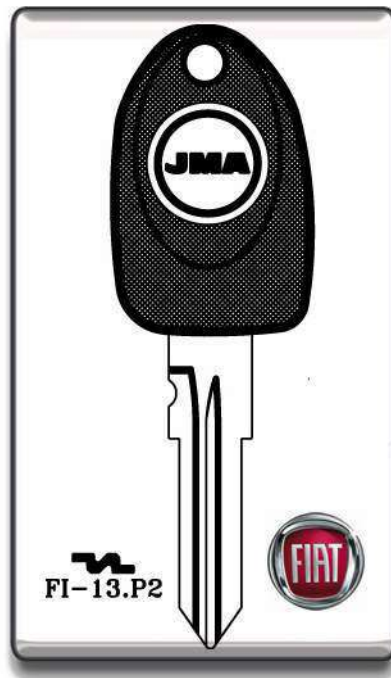

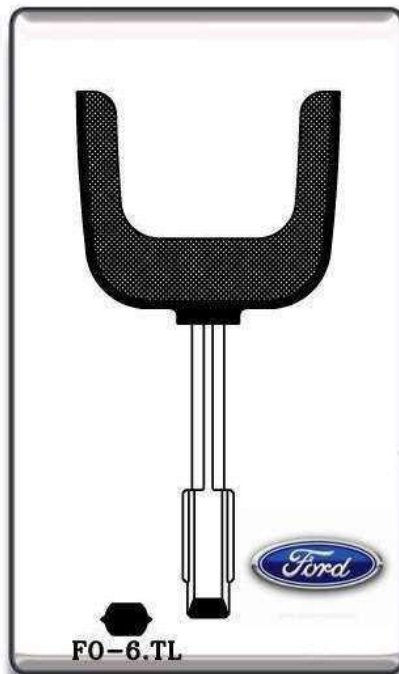
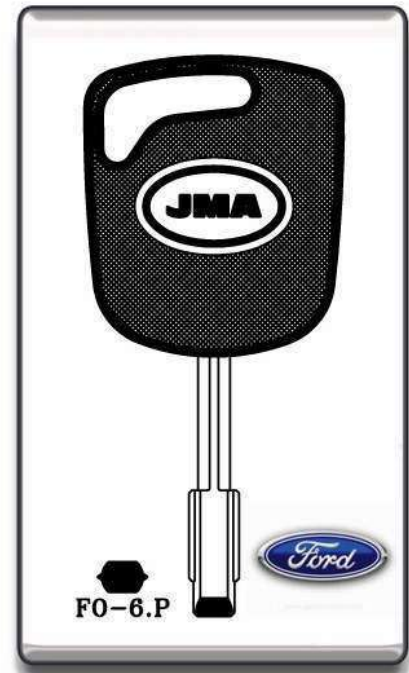



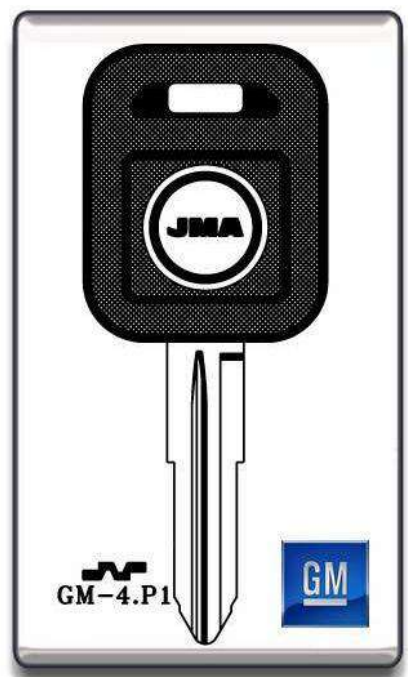
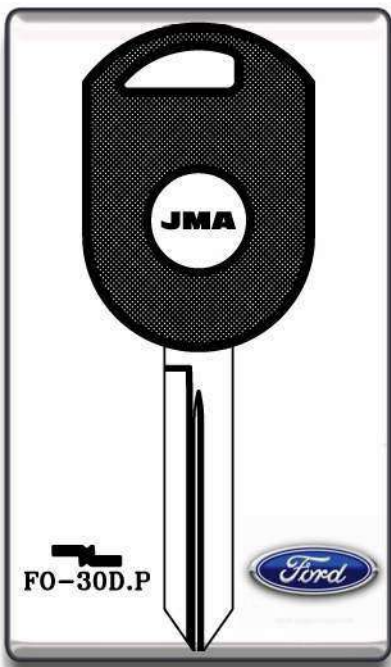
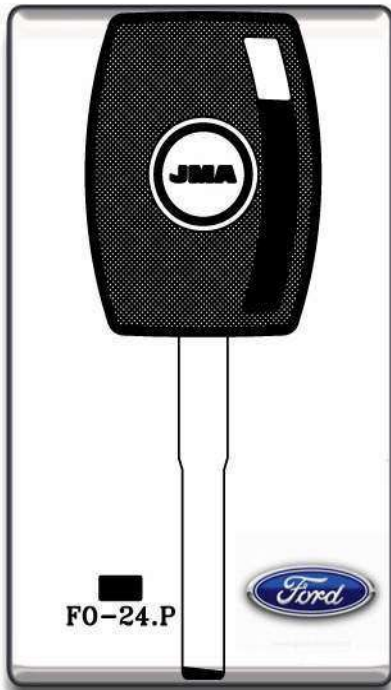



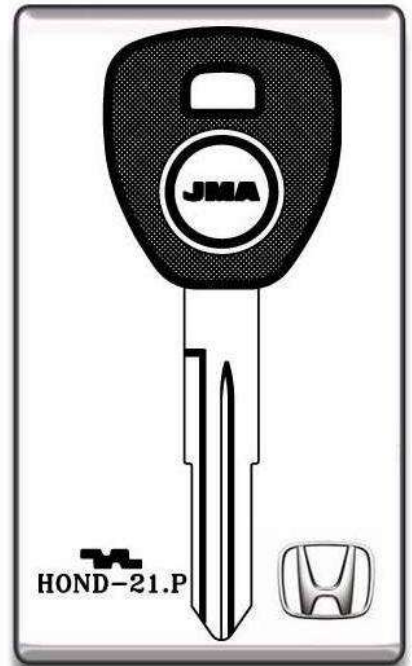
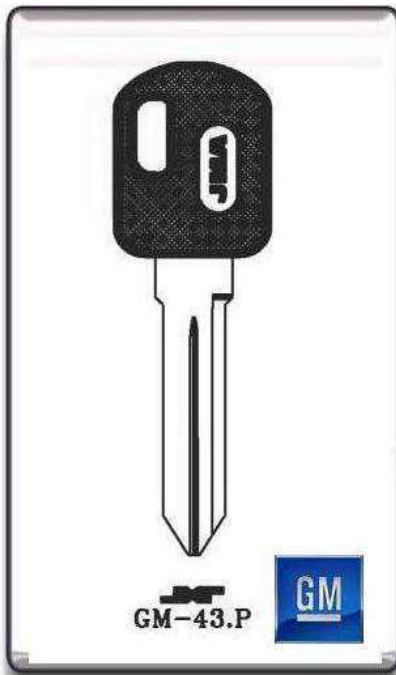
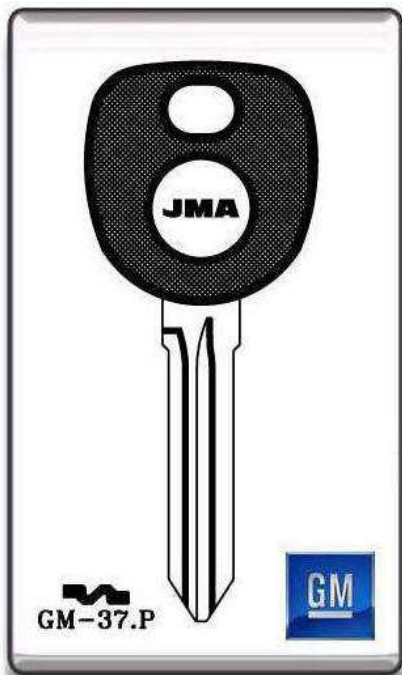
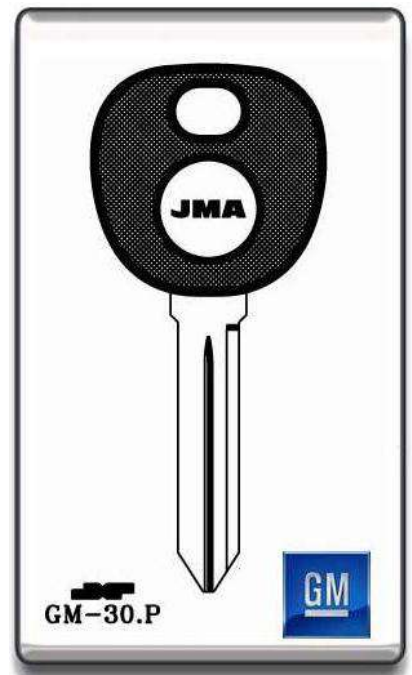
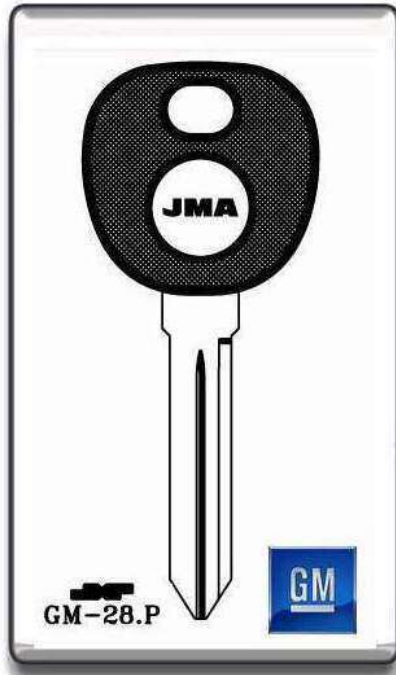
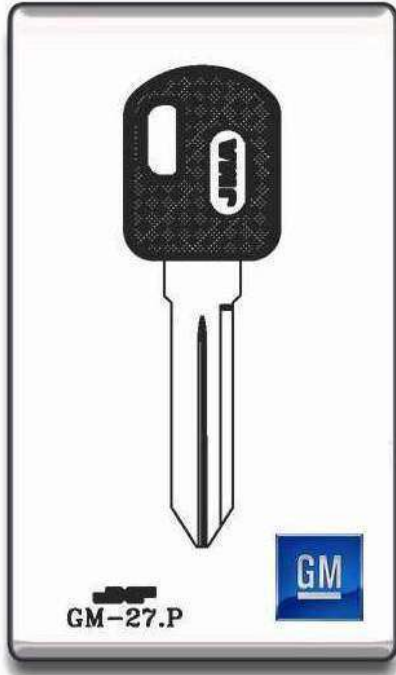

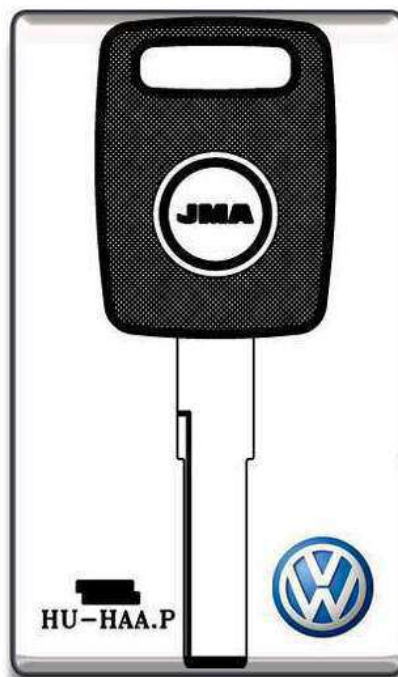
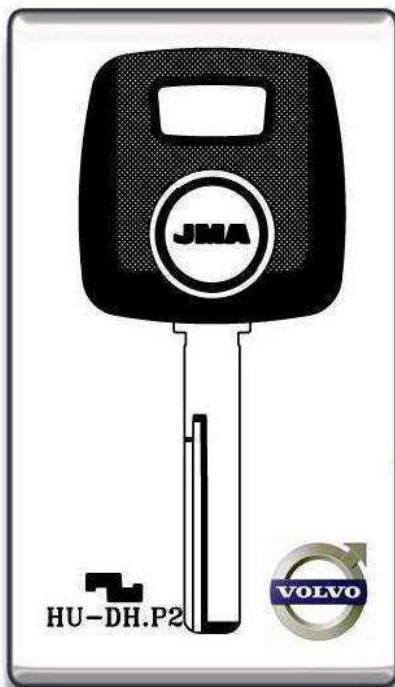
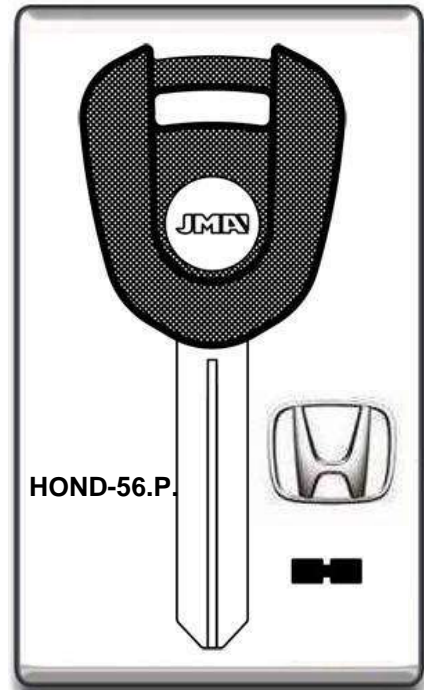
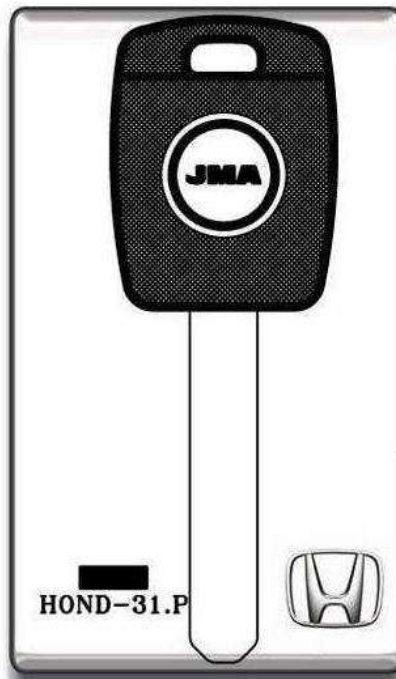



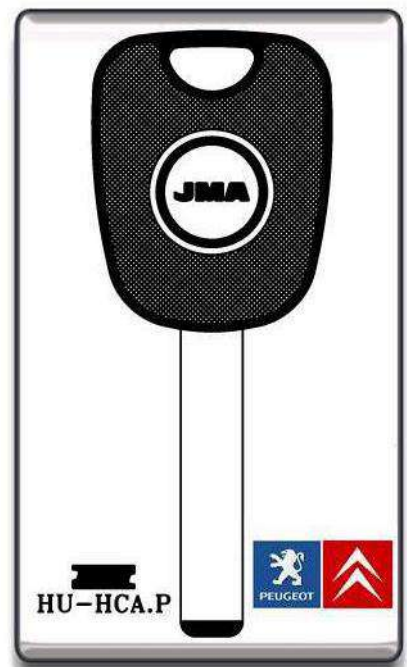



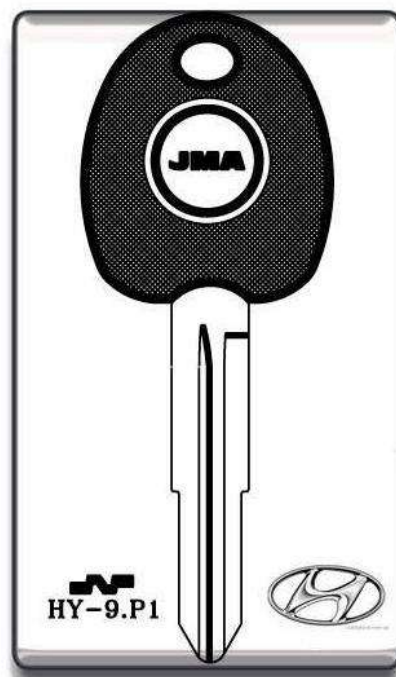
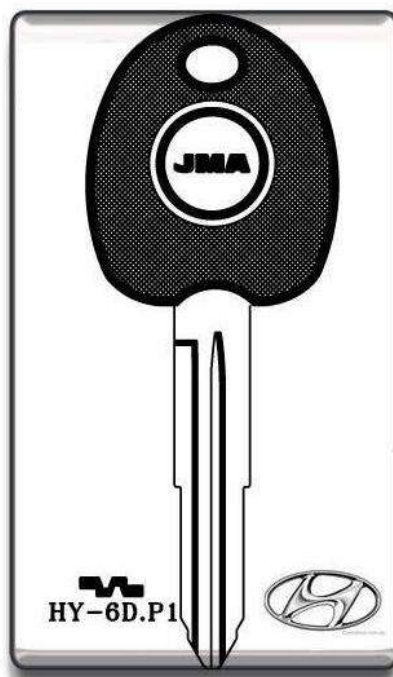
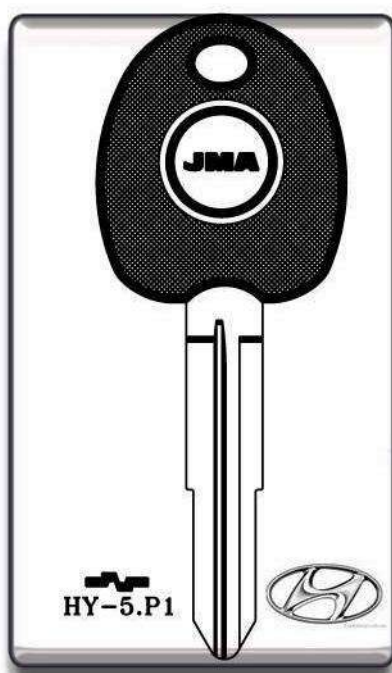
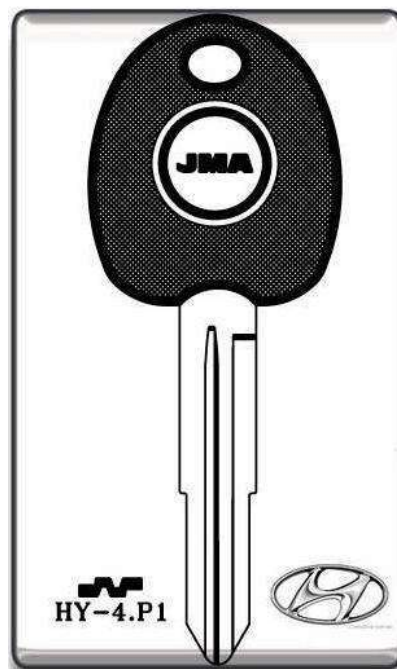
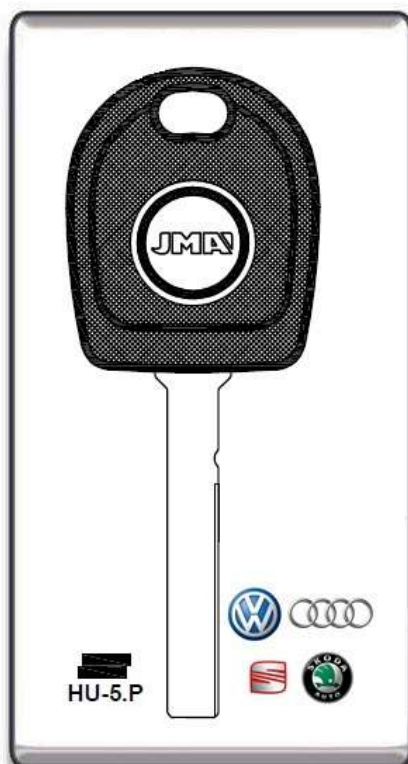

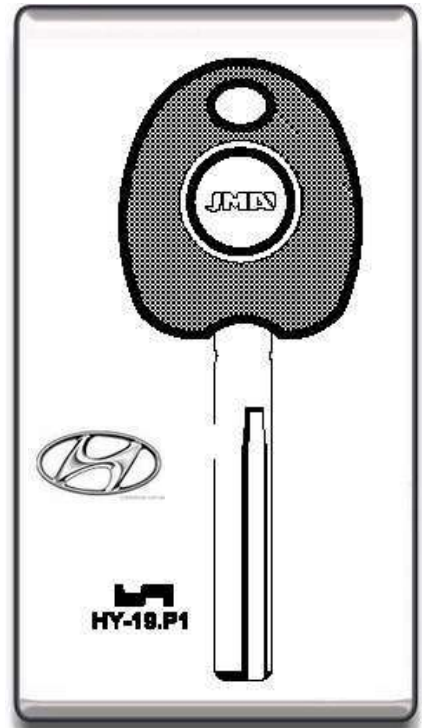
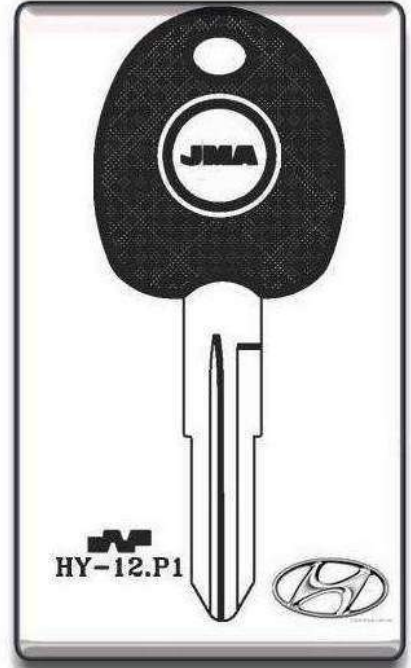
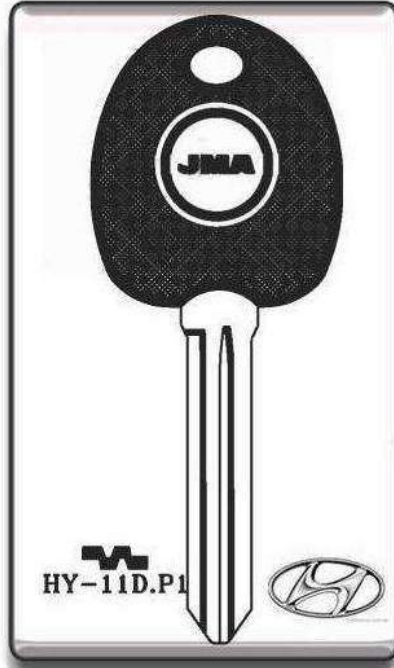
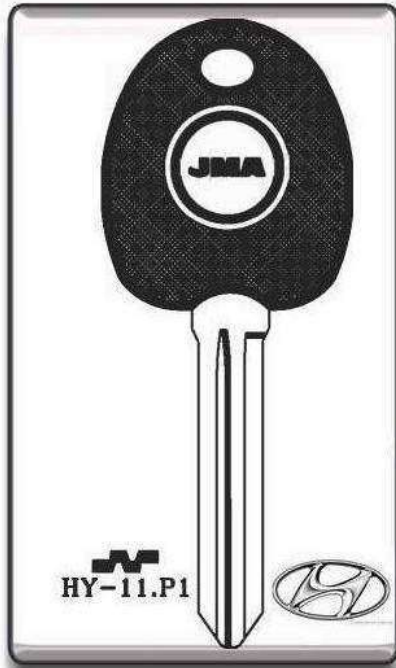



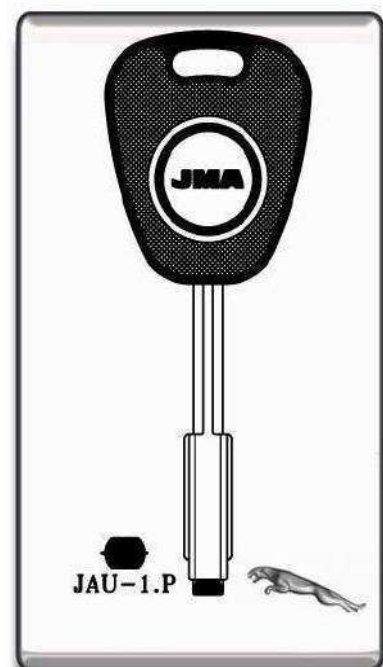
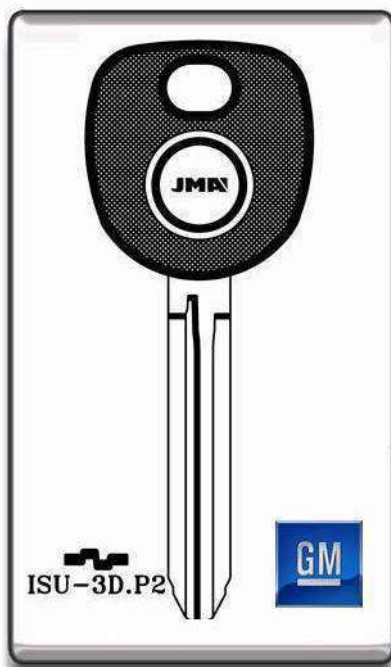
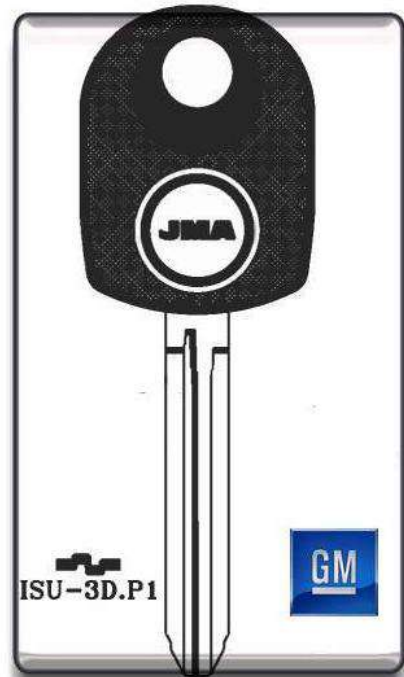
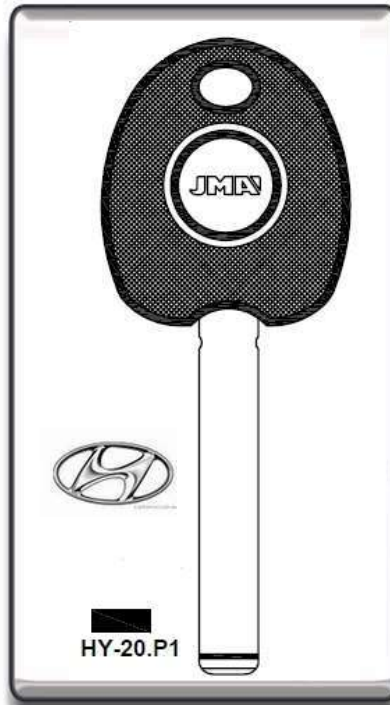



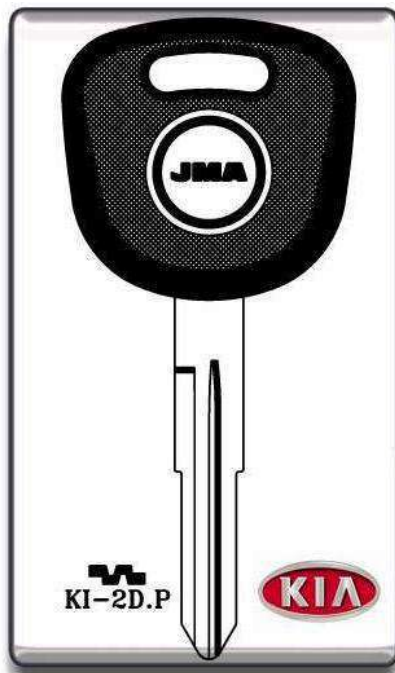
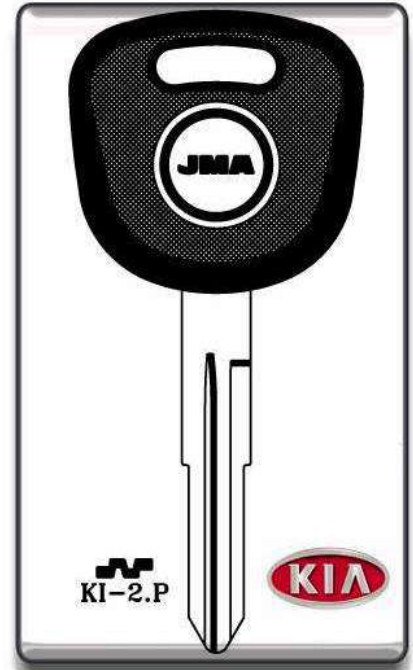
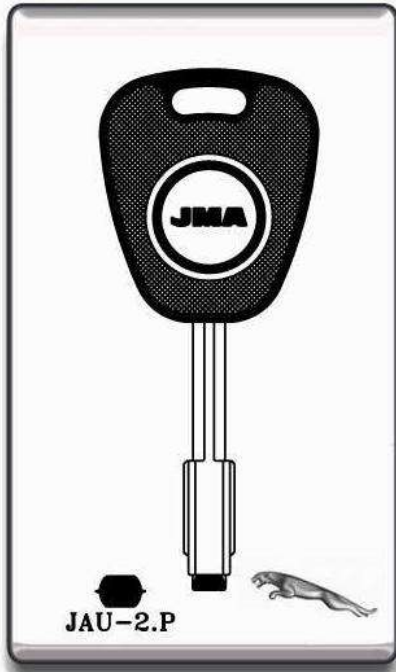

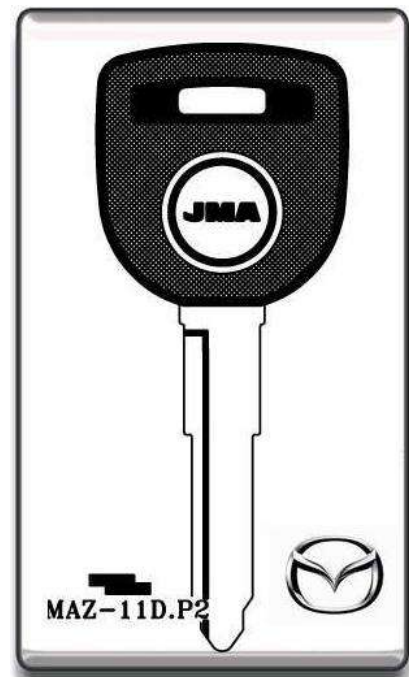
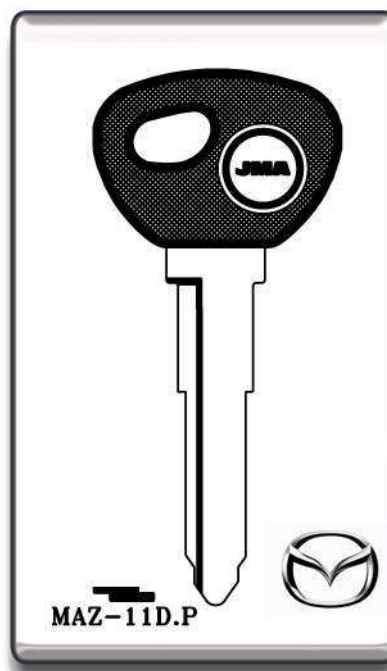
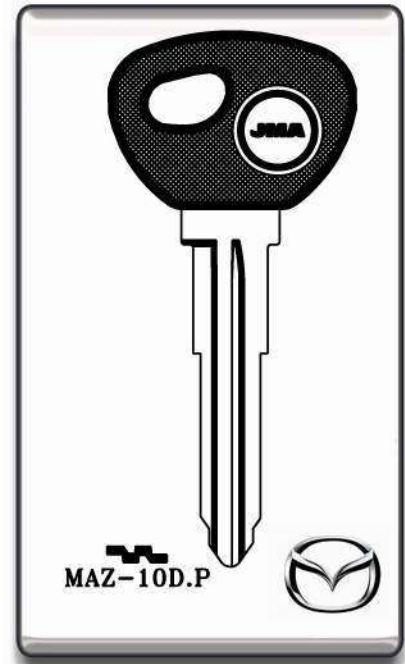
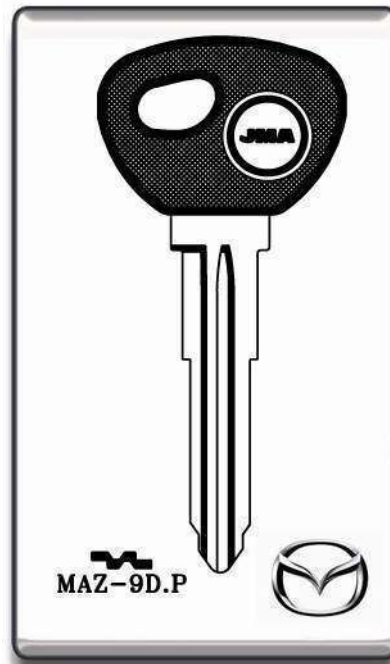



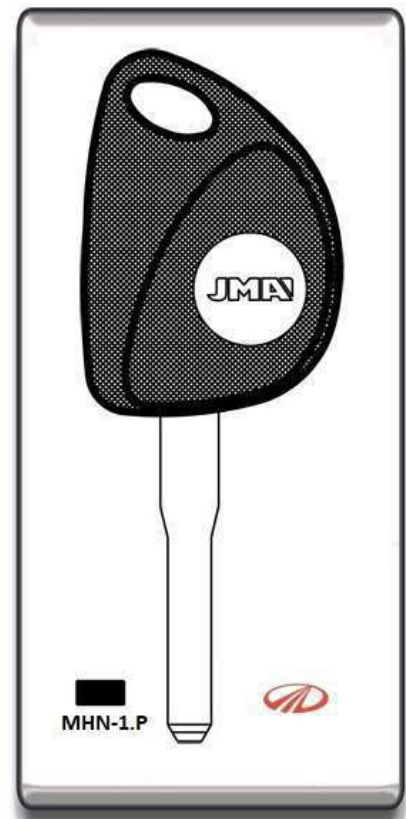
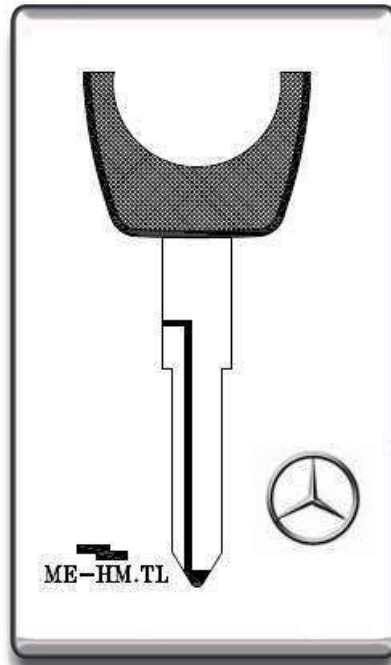
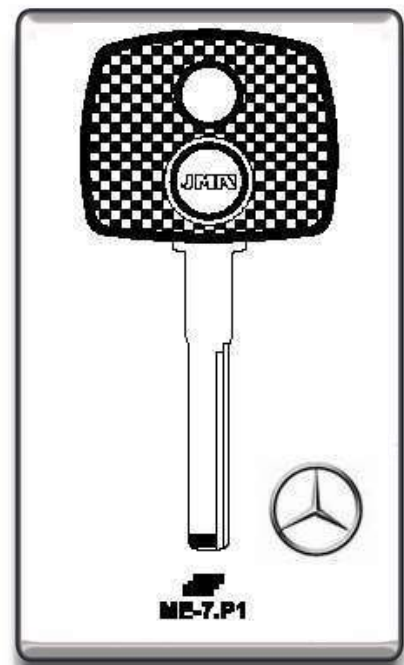
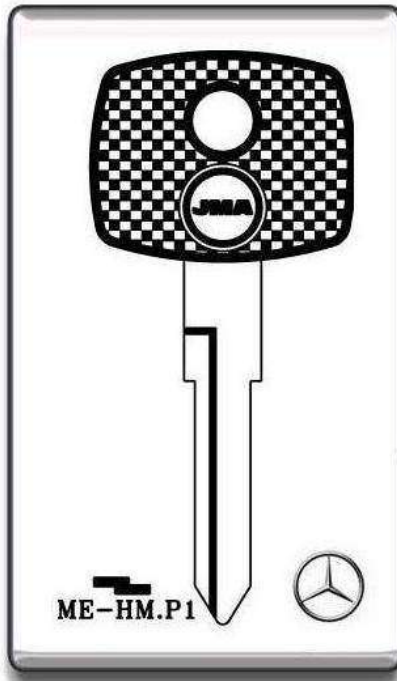
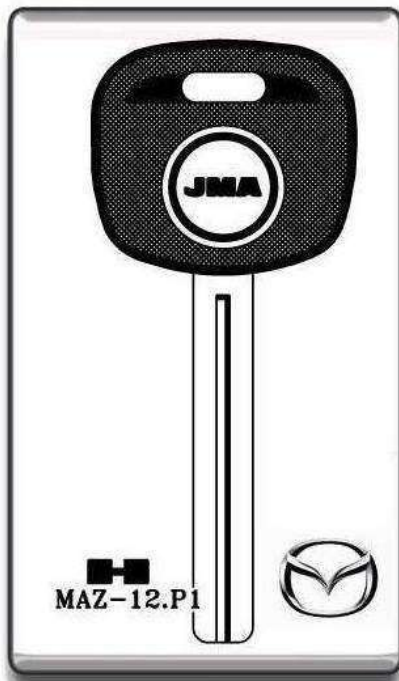



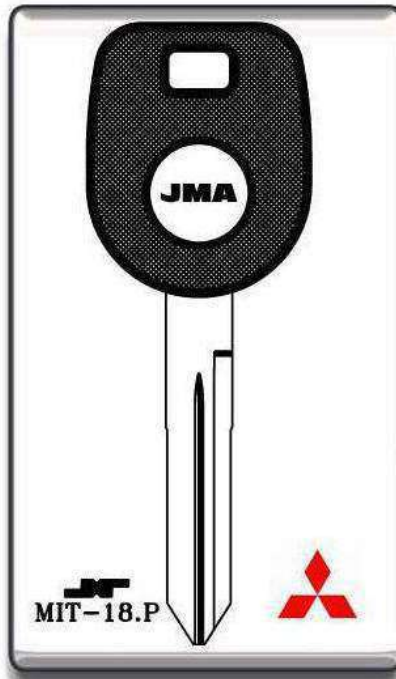
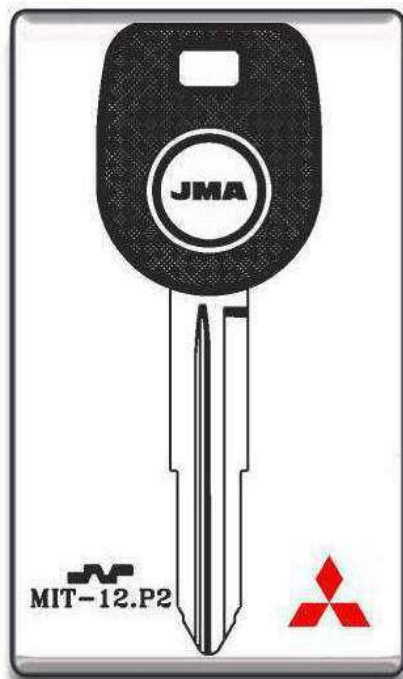
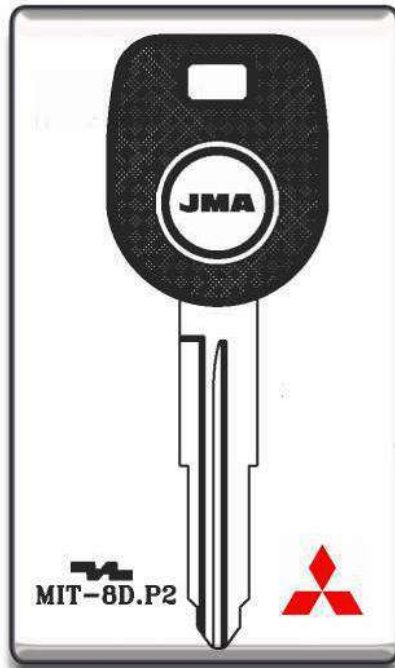
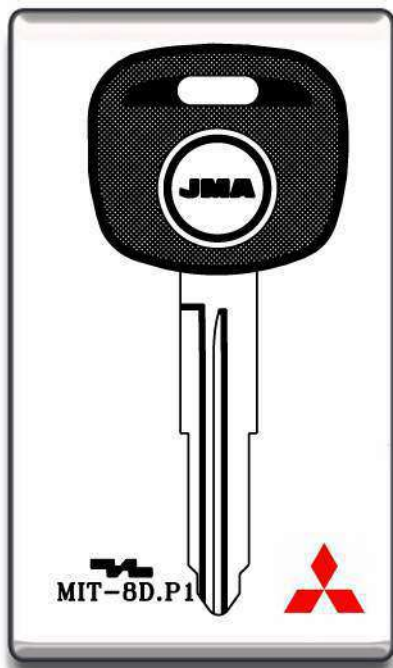

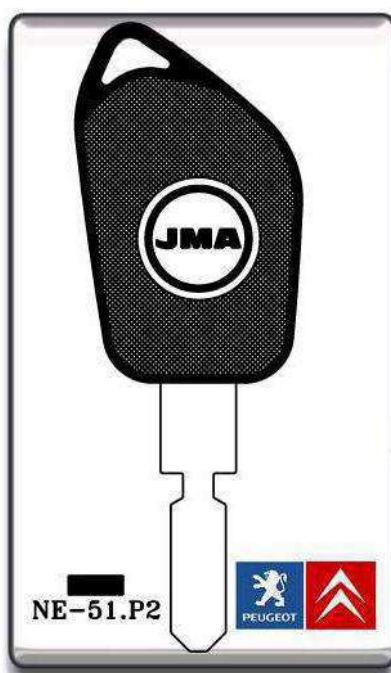
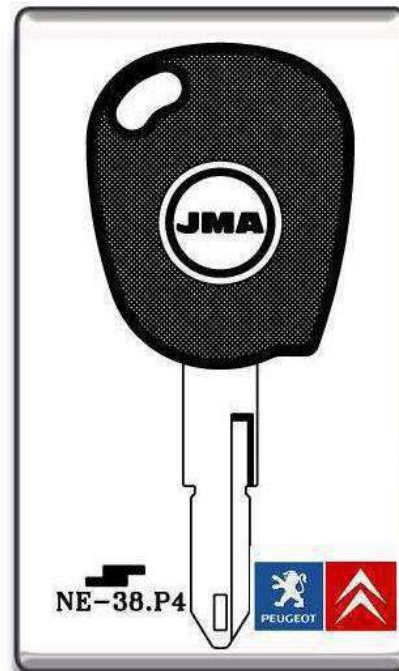
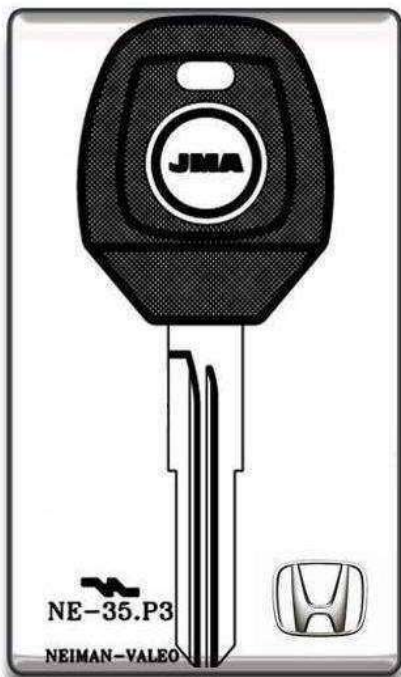



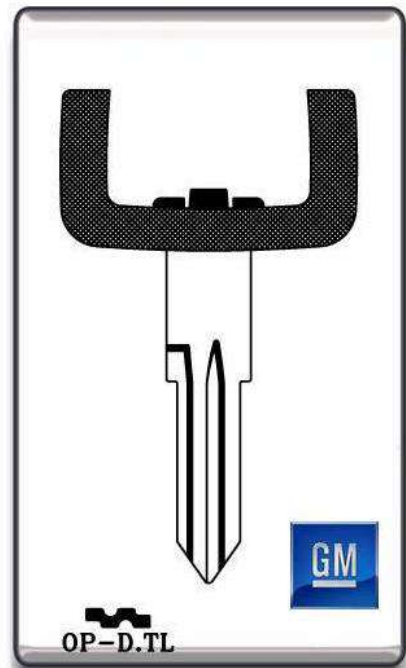
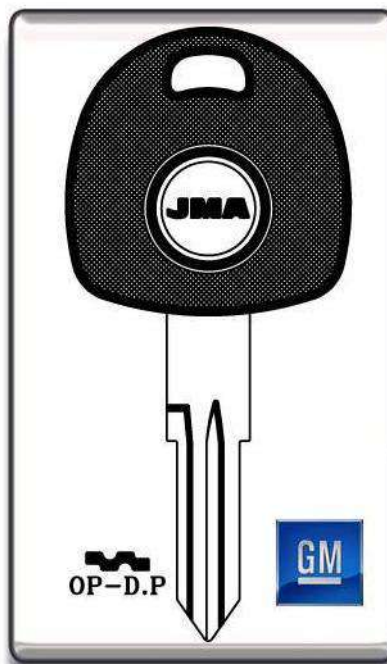
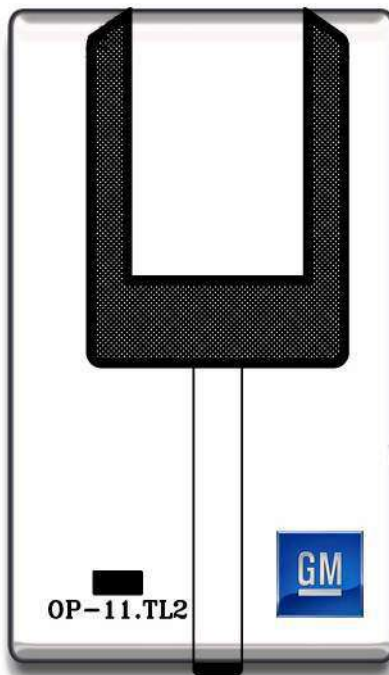
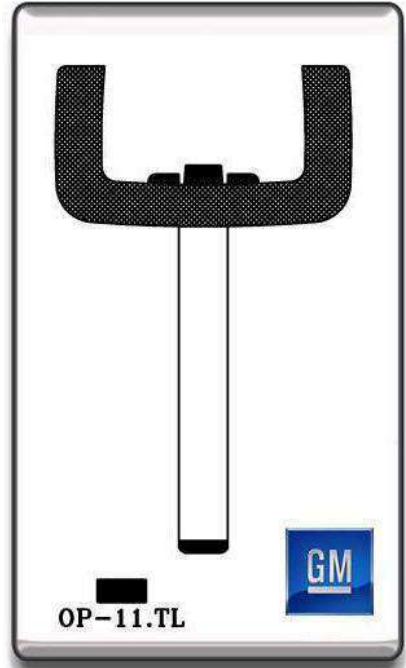
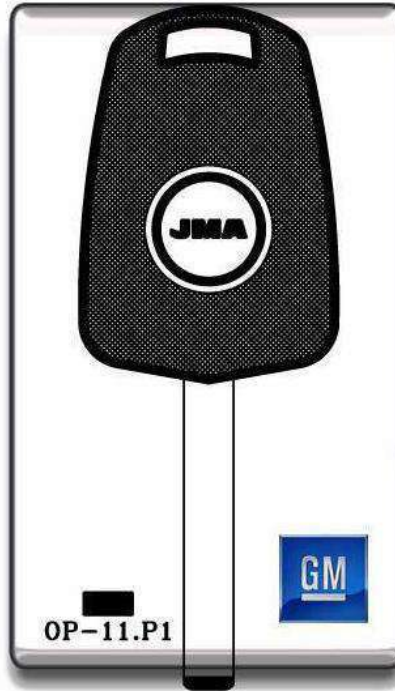
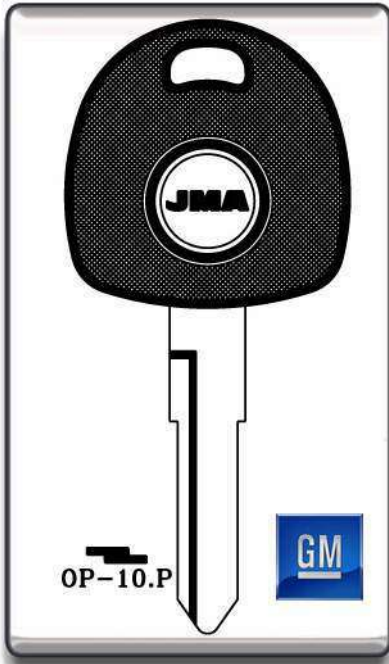



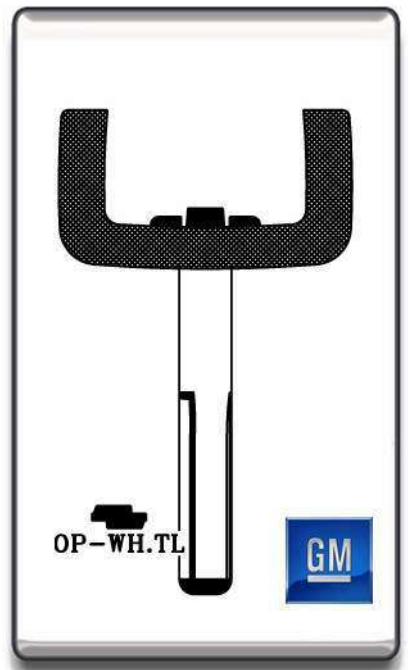
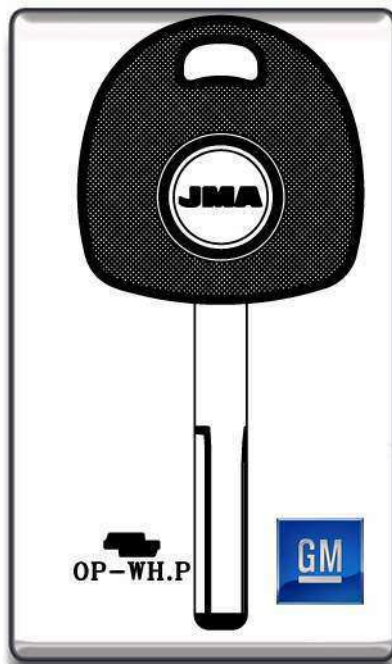
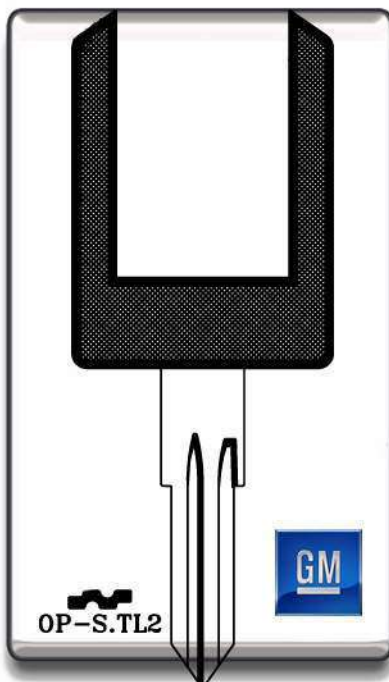
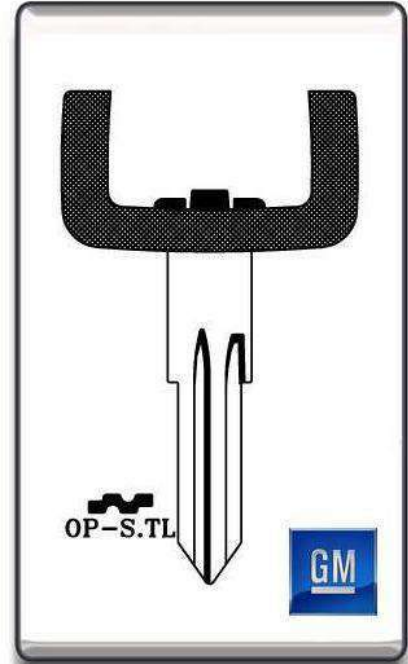
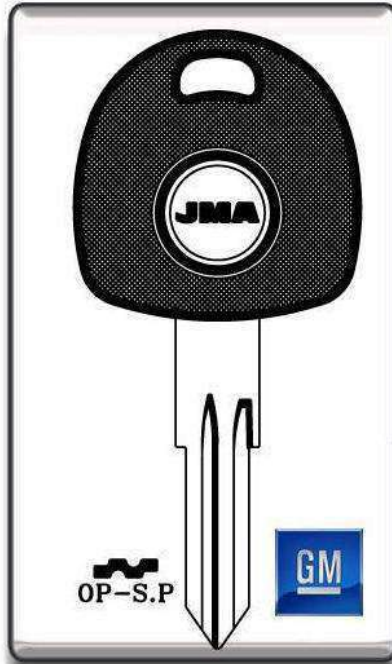
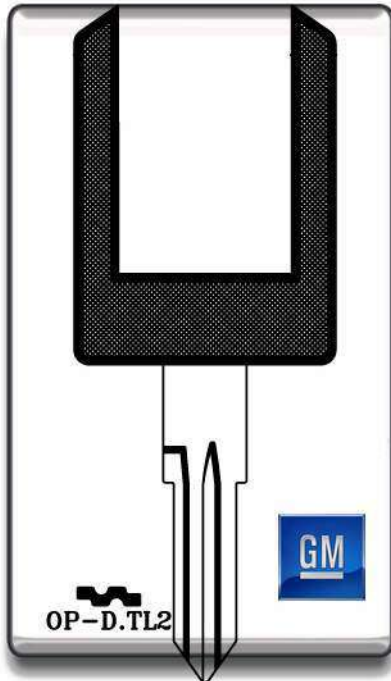

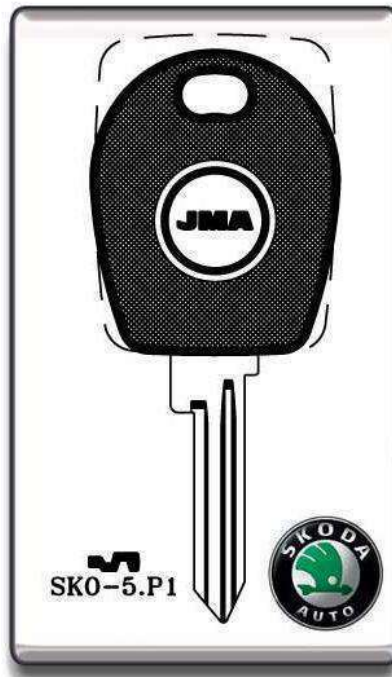
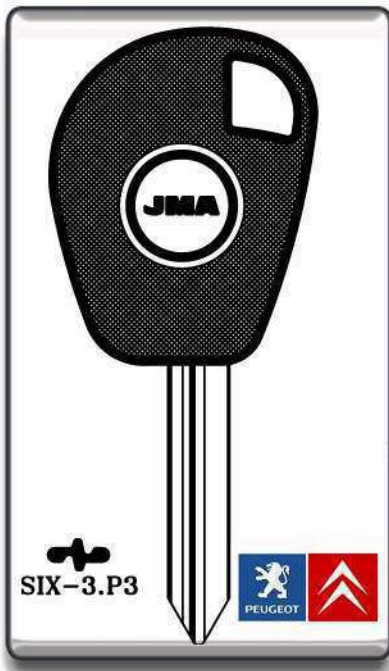
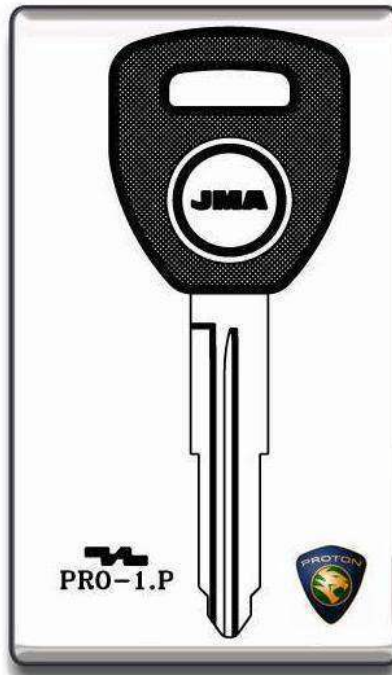
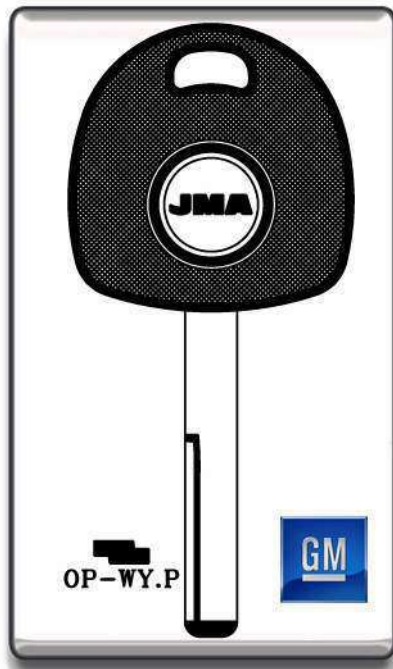



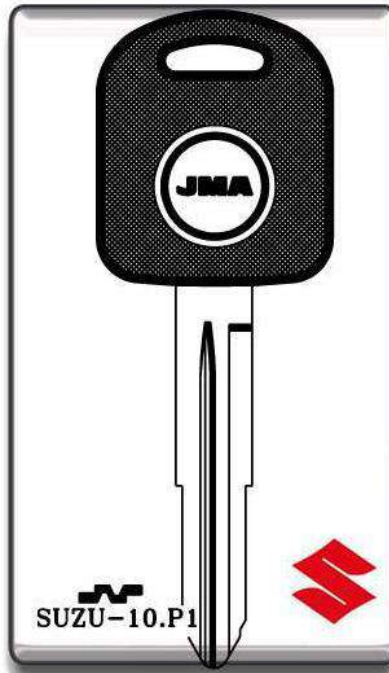
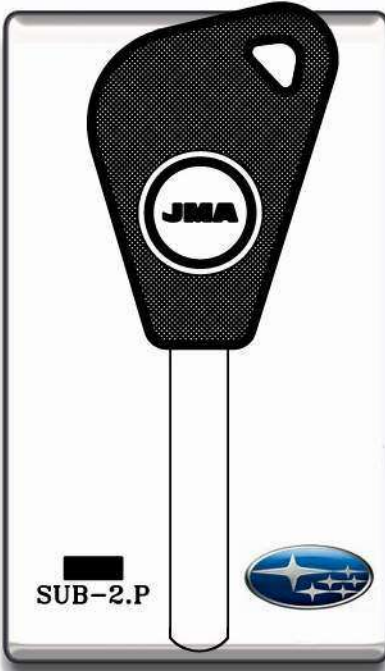



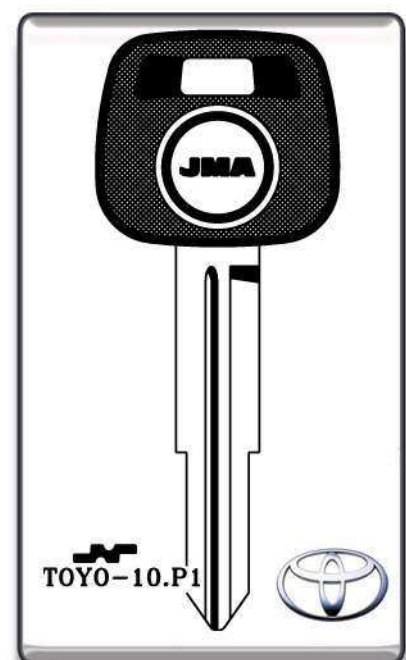
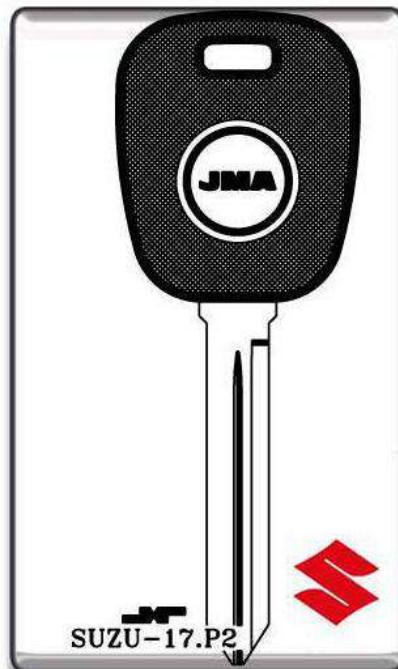
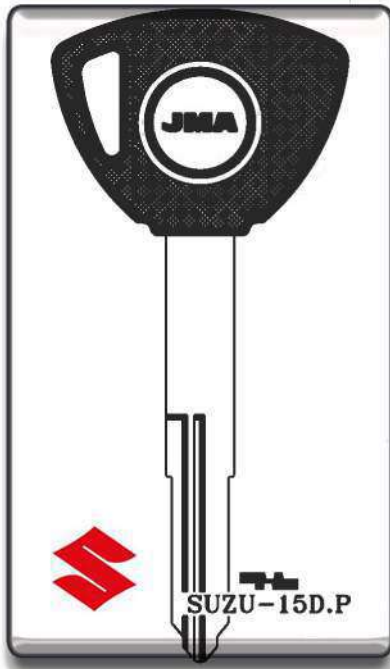

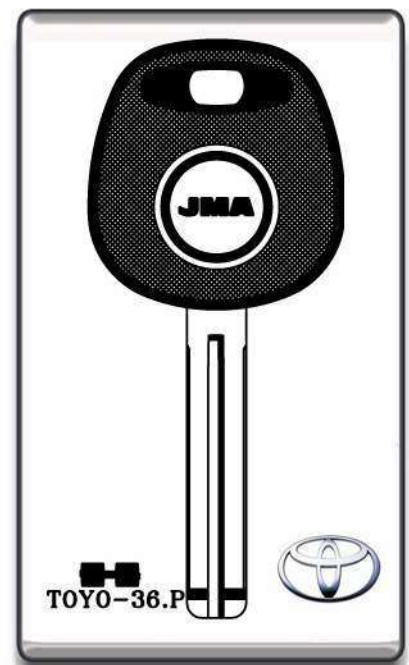
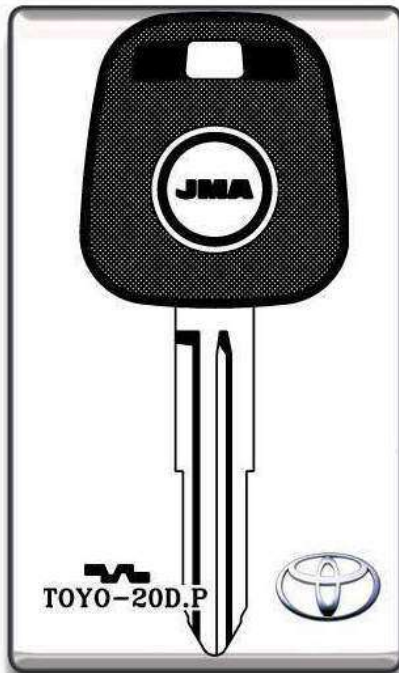
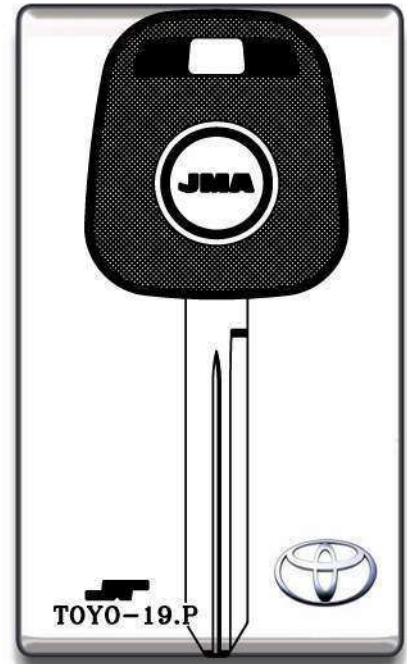
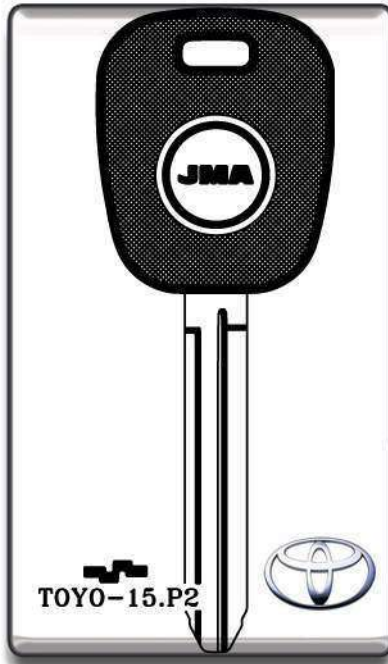
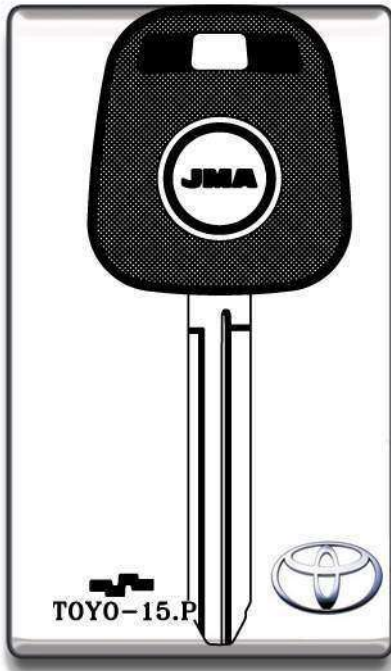



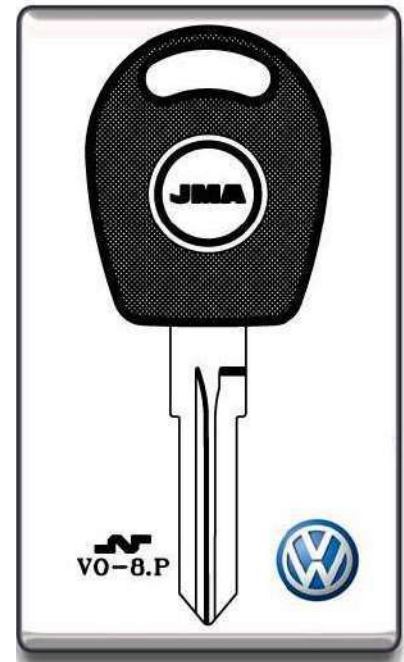
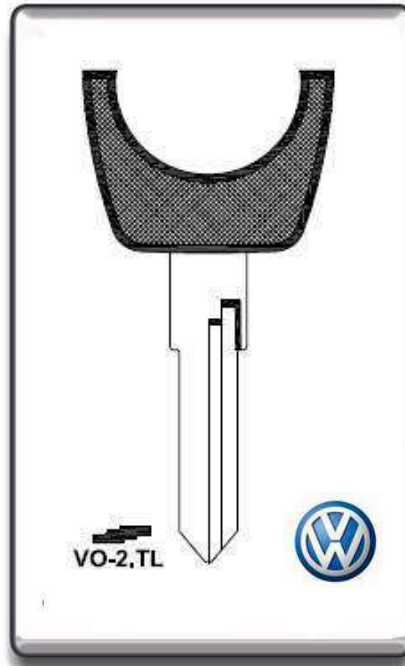
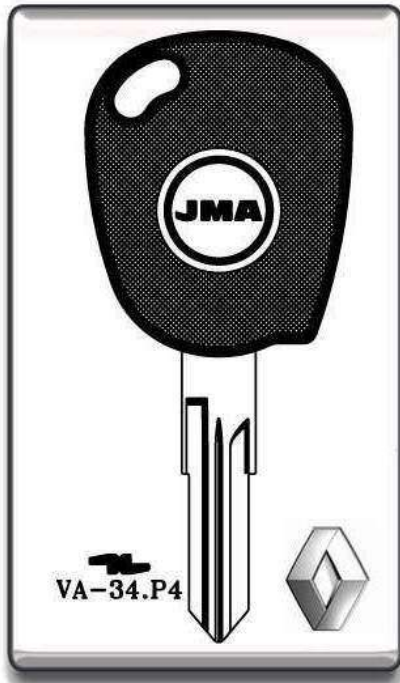



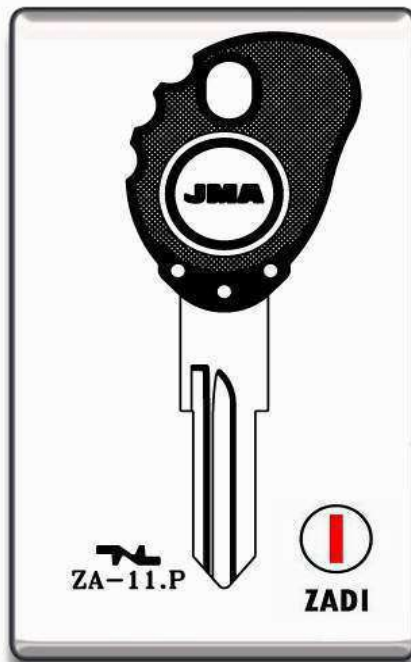
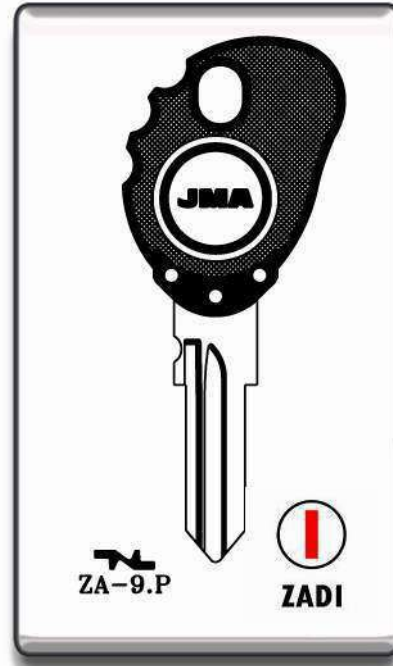
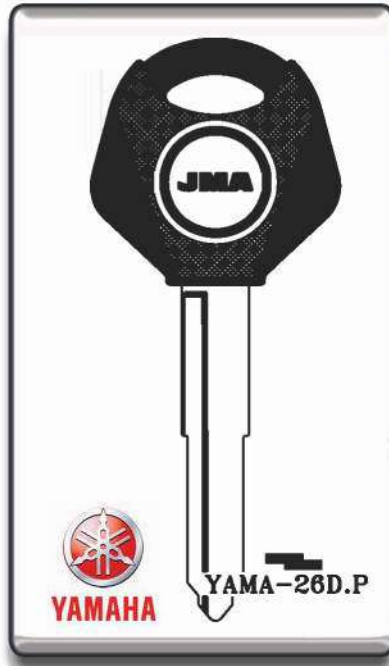

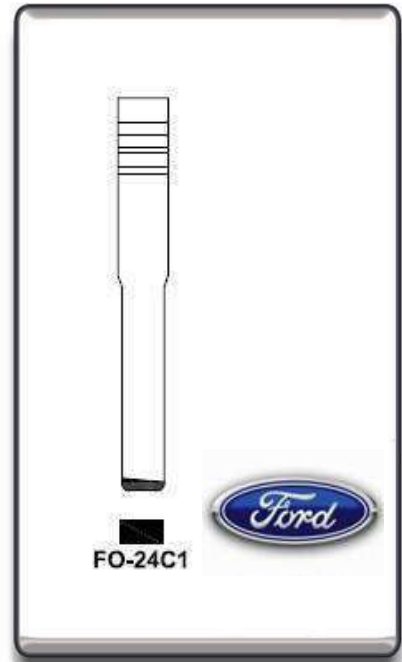
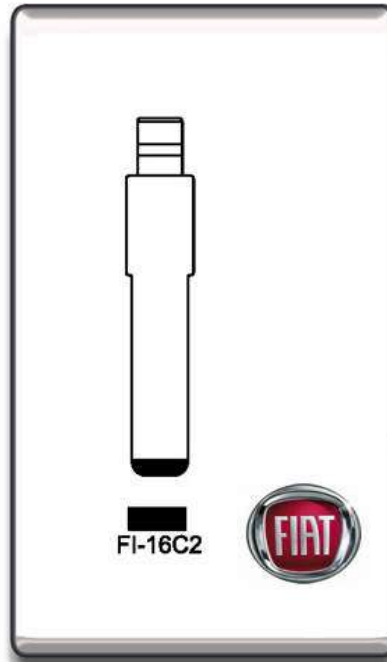
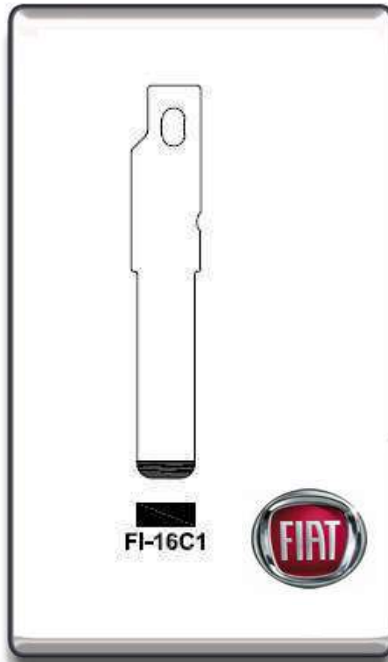
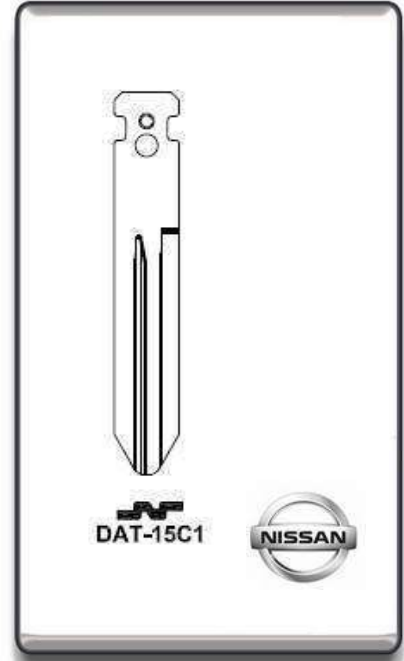
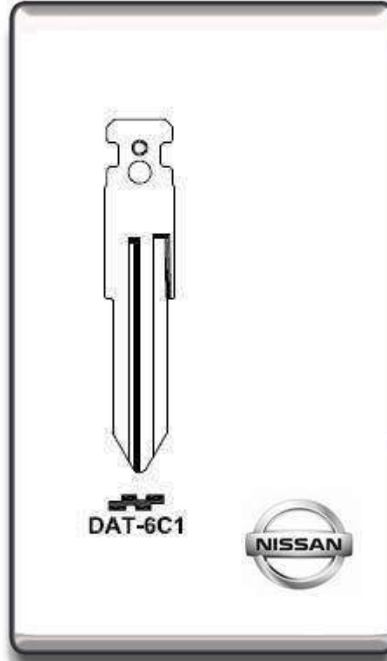
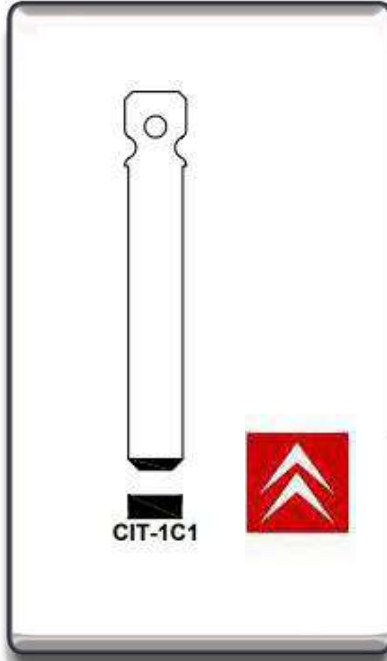

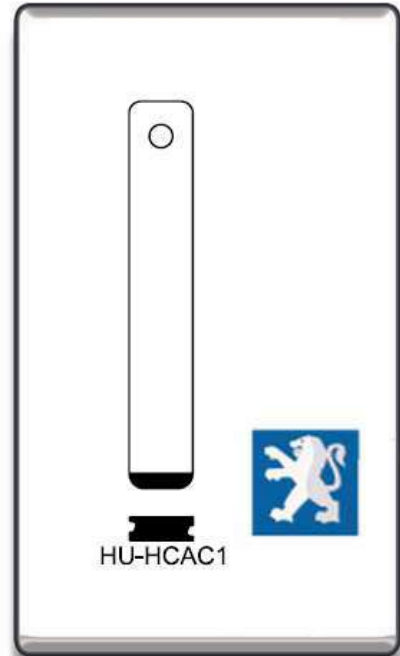
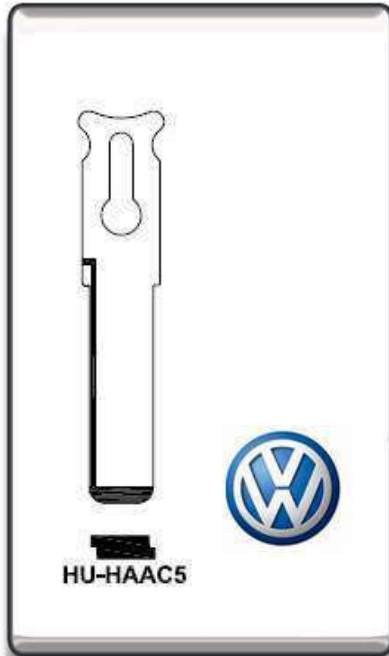
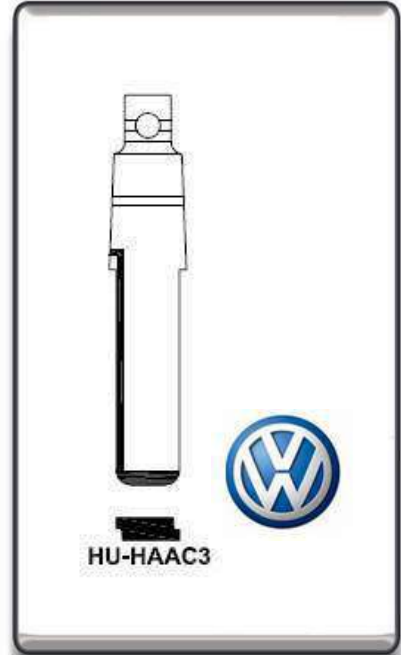
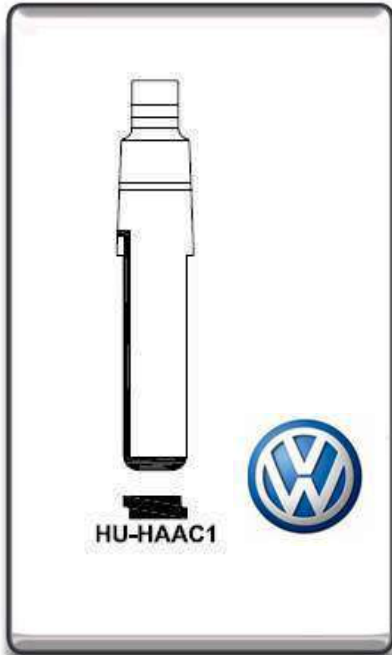



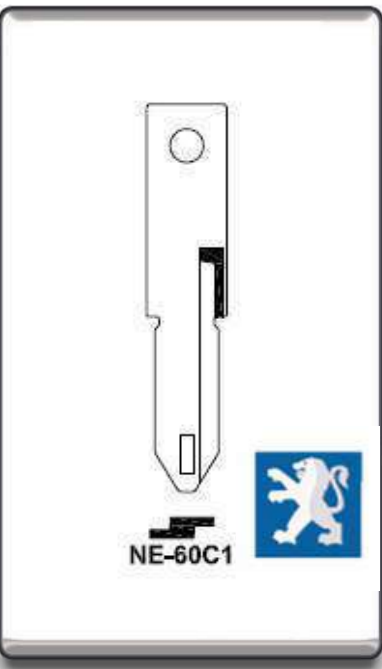

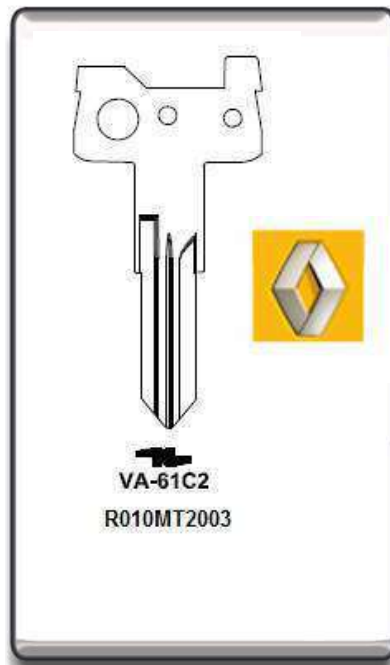
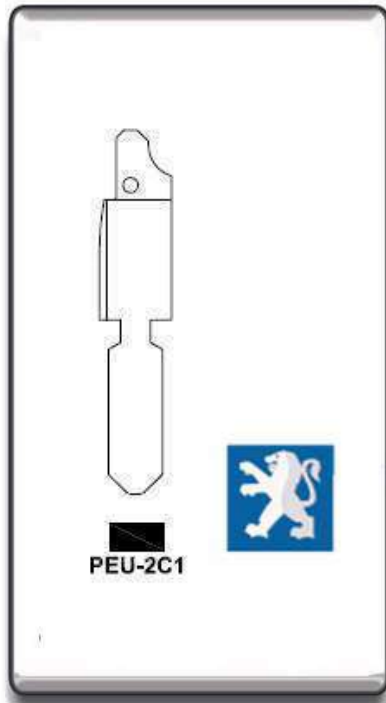
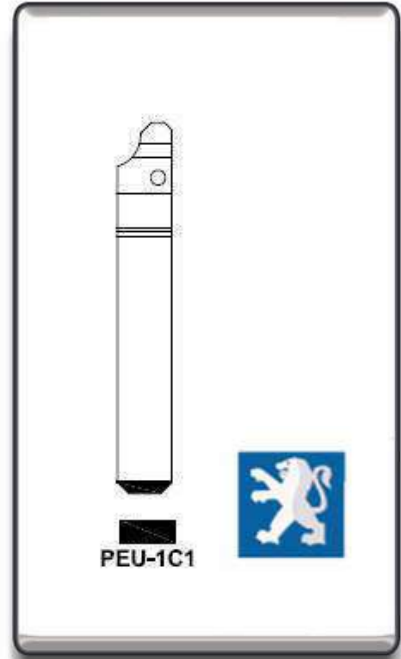
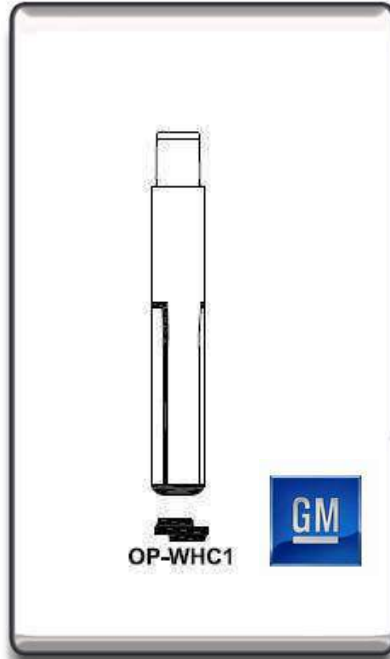
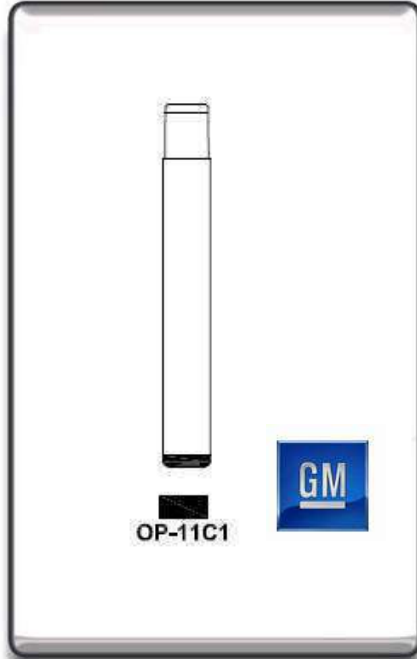







Maquinaria e insumos de cerrajería

Cuevas 1505, Santiago - Chile

Fono: (56 2) 2556 23 78

Email: [contacto@bcnllaves.cl](mailto:contacto@bcnllaves.cl)

[www.bcnllaves.cl](http://www.bcnllaves.cl)