



Infinite
Peripherals®

INFINEA® X



INFINEA X

USER MANUAL



LEGAL NOTICE

“Made for iPod” and “Made for iPhone” mean that an electronic accessory has been designed to connect specifically to the iPod or iPhone respectively, and has been certified by the developer to meet Apple performance standards. Apple is not responsible for the operation of this device or its compliance with safety and regulatory standards. Please note that the use of this accessory with iPod or iPhone may affect wireless performance.

TRADEMARK CREDITS

Infinite Peripherals, Mobilize Your Enterprise, Linea Pro, Infinea, Infinea Tab and Infinea Omni are trademarks of Infinite Peripherals, Inc. All other trademarks are the property of their respective owners.

COMPATIBILITY

Made for:

- iPod touch® 6th generation mobile digital device
- iPod touch® 5th generation mobile digital device
- iPhone® 7 mobile digital device
- iPhone® 6S mobile digital device
- iPhone® SE mobile digital device
- iPhone® 5s mobile digital device
- iPhone® 5 mobile digital device

Table of Contents

CONTACT INFORMATION	2
LEGAL NOTICE	3
COMPATIBILITY	3
TRADEMARK CREDITS	3
BOX CONTENTS	6
Before Using Your Infinea X	6
ACCESSORIES	6
FEATURES	7
GETTING STARTED	8
Warnings, Cautions, and Notes	8
First Steps	8
DEVELOPING APPLICATIONS FOR YOUR INFINEA X	9
PRODUCT OVERVIEW	10
Infinea X	10
<i>Figures 1a and 1b: Front and Back</i>	10
<i>Figure 2a and 2b: Top and Bottom</i>	11
<i>Figure 3a and 3b: Left and Right Sides</i>	11
Infinea X	12
ASSEMBLING YOUR INFINEA X	13
iPhone and iPod Installation	13
INSTALLING THE BATTERY PACK	14
Standard and Extended Battery Installation	14
CHARGING YOUR INFINEA X	15
Battery Specifications	15
Charging Using an Electrical Outlet	16
Charging the User Replaceable Battery	17
<i>Figure 7: Multi-bay Battery Charger</i>	17
Battery Disposal	17
POWERING ON YOUR INFINEA X	18
Dual Purpose Scan Button	18
Power On	18
<i>Figure 8: Scan/Power Button</i>	18
Barcode Scanning	19
RFID	19
<i>Figure 9: RFID Antenna</i>	19
Audio	20
<i>Figure 10: Speakers and Toggle Button</i>	20

STATUS AND OPERATIONAL MODES	21
Programmable LED Status.....	21
<i>Figure 11: Programmable LED Status</i>	<i>21</i>
Rear Speaker/Microphone Status	22
<i>Figure 12: Speaker/Microphone Status</i>	<i>22</i>
Manually Enable/Disable Rear Speaker	22
RESETTING YOUR INFINEA X.....	23
<i>Figure 13: Reset Feature</i>	<i>23</i>
SYNCING YOUR INFINEA X	24
<i>Figure 14: Sync Feature.....</i>	<i>24</i>
TROUBLESHOOTING	25
Troubleshooting—General	25
Troubleshooting—Scanner.....	25
Troubleshooting—RFID.....	26
CLEANING YOUR INFINEA X	27
Precautions	27
Cleaning guidelines for the Infinea X.....	27
TECHNICAL DATA	28
WARRANTY	32
DISCLAIMER.....	32
PRODUCT RETURNS AND SERVICING	32
SYMBOLS FOR USE.....	33
FEDERAL COMMUNICATIONS COMMISSION.....	34
Federal Communications Commission (FCC) Statement	34
FCC RF Radiation Exposure Statement.....	34

BOX CONTENTS

Before Using Your Infinea X

- Remove the device and any included accessories from the shipping carton and verify contents against your packing list.
- Retain all packing materials, invoice, and bill of lading. These may be required to return the device for servicing later, or to process a claim with the shipping carrier.
- Carefully inspect the contents inside of the packaging for any signs of damage. If there are signs of damage, DO NOT attempt to use the unit. Notify your account executive or contact our technical support at support@ipcmobile.com.
- Ensure the battery is fully charged prior to initial use.

Your **Infinea X** includes the items listed below:



*Infinea X (1)



*Standard Battery (1)



Torx T6 Screws (6)



*Charging Cup (1)



*Torx T6 Key (1)



Quick Start Guide (1)

**Note: Box contents and part numbers may vary based on order configuration.*

ACCESSORIES

Please visit our website at ipcmobile.com, or contact your Infinite Peripherals account representative, for additional information about our current and future product accessory offerings.

FEATURES



The Infinea X allows you to scan barcodes into an iPod touch or iPhone. Before using the Infinea X, the battery should be fully charged. The following table will help you get your Infinea X ready for use.

Feature	Description
Barcode Scanner	The Infinea X supports one-dimensional (1D) and two dimensional (2D) barcode symbols, which can be read in any direction (omni-directional). The effective reading distance of the barcode reader varies depending on the barcode size. The barcode scanner is capable of reading barcodes on a LCD screen.
RFID <i>(Radio Frequency Identification)</i>	The Infinea X has an RFID (Radio Frequency Identification) tag/card reader with read and write capability at 13.56 MHz.
Audio	The Infinea X has built-in, front and rear amplified speakers that are programmable through the Universal SDK.
Battery	User replaceable Li-ion battery.
Indicators	The Infinea X has three programmable indication features: audible, visual and haptic. An Internal electromagnetic buzzer provides the audible indicator. For visual indications, there are 4 multi-color SDK programmable LEDs (blue, green, red and orange). These LEDs also provide battery status. The haptic indicator is a programmable vibration motor.
Power Monitoring	The Infinea X contains an on board fuel gauge that facilitates accurate monitoring of significant battery attributes using the SDK.
Bluetooth Compatibility	Available Bluetooth 2.0 SPP compatibility, which allows connection to a Bluetooth peripheral, such as a printer.
Ruggedized Case	The Infinea X case is IP54 rated for protection against dust and fluid ingress. The case material is antimicrobial, which inhibits growth of bacteria on the product.

GETTING STARTED

Warnings, Cautions, and Notes

Please observe the **Warnings**, **Cautions**, and **Notes** presented throughout this manual. An explanation of these items is provided below:

Symbol	Description
 WARNING	Actions may result in a serious outcome to the user (e.g., injury, death or other adverse affect).
 CAUTION	Special care is required to avoid damage to the product or other property.
 NOTE	Important points and tips about the product are being provided.

First Steps

Step	Purpose	Additional Information
1. Install the Battery	The Infinea X battery is shipped with approximately 50% of full charge capacity and should be fully charged before initial use.	See manual section: INSTALLING THE INFINEA X BATTERY PACK
2. Charge the Infinea X		See manual section: CHARGING YOUR INFINEA X
3. Install Software	Use of the Barcode Scanner, RFID reader and LED indicator features requires the installation of software on your iPod or iPhone.	See manual section: DEVELOPING APPLICATIONS
4. Power on the Infinea X	Initialize barcode scanner and/or RFID functions for use.	See manual section: POWERING ON YOUR INFINEA X

DEVELOPING APPLICATIONS FOR YOUR INFINEA X

Software is not provided with your Infinea X. Please contact your reseller or Infinite Peripherals for Third Party software solutions.

Integrating the Infinea X into your iOS application requires the use of the Infinite Peripherals Universal SDK. The SDK incorporates an API specifically for developing applications to use the functionality of the Infinea X; including, but not limited to, barcode scanning, read/write RFID and programmable LED capability of the Infinea X.

For additional details on using the Infinite Peripheral Universal SDK, please refer to the SDKs documentation.

For the latest Infinite Peripheral Universal SDK please visit our developer portal:

developer.ipcmobile.com/

PROGRAMMABLE OPTIONS

Optional settings for the Infinea X may be configured via the SDK.

Programmable Options	Description
Set Charging	Enables or disables battery backup sharing capability to charge the iOS device from the IX removable battery.
Charging Current	Charging current may be set to 500mA or 1A. Default setting is 1A.
Scan Mode	<p>The Infinea X Mini supports the following Scan modes:</p> <ul style="list-style-type: none"> • Single Scan Scanning a single barcode by pressing the Scan button. • Multi Scan Scanning multiple barcodes by pressing and holding the Scan button. • Motion-Detect Scanner is activated automatically when barcode is placed near the barcode engine. • Multi-Scan without Duplicates Scanning multiple barcodes without duplicates.
Pass Through Sync	<p>When the pass through sync setting is enabled and the USB cable is plugged in, the iOS device may be synced with a PC or MAC. Default setting is "OFF".</p> <p><i>Note: If Pass Through Sync is enabled, the iOS device will not charge when plugged into an external charger.</i></p>
Time Out	<p>Set timeout for 60 or up to 64800 seconds (18 hrs.).</p> <p><i>Note: Default setting is subject to change for this feature based on specific use or integration.</i></p>

PRODUCT OVERVIEW

Infinea X



Figures 1a and 1b: Front and Back

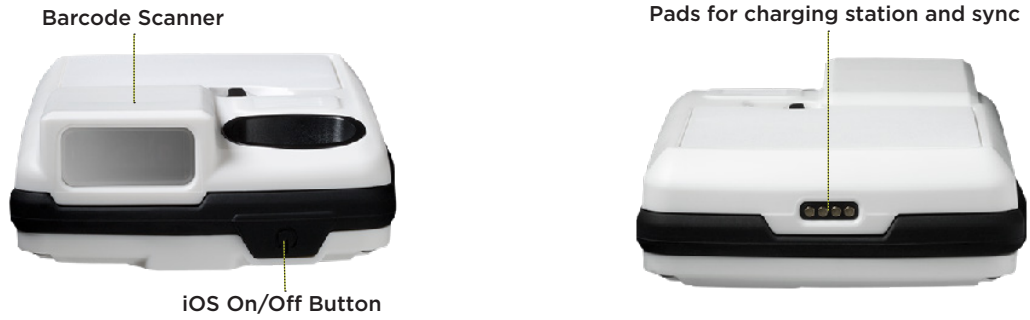

Figure 2a and 2b: Top and Bottom



Figure 3a and 3b: Left and Right Sides

Infinea X



ASSEMBLING YOUR INFINEA X

iPhone and iPod Installation

1. Open the Infinea X by loosening the torx screws and gently flipping open the top cover. Slide the iOS product* onto the Lightning Connector and audio jack until it clicks into place.

*Note: *Infinea X is molded specifically to iPod touch 5th and 6th generation and iPhone 5, 5s, and SE. iOS devices are not interchangeable.*

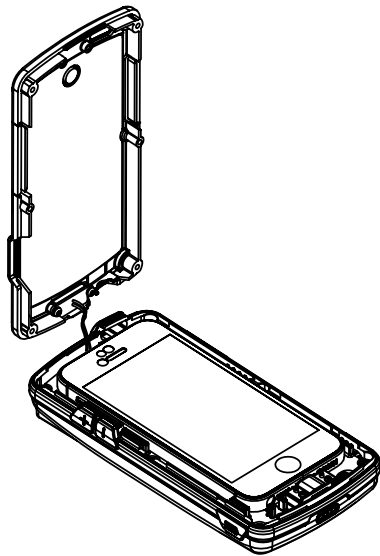
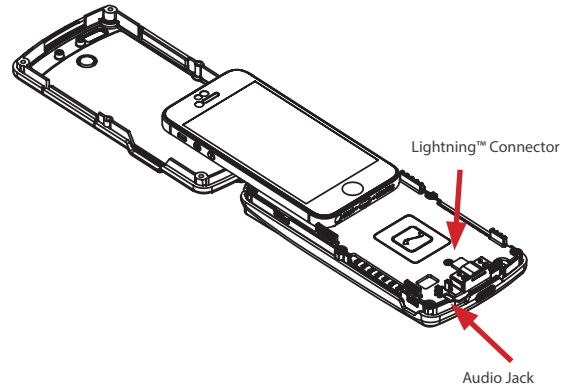

2. Close the top cover, being careful not to pinch the wires, while maintaining the position of the protective rubber bumper.

3. Secure the cover by inserting (6) torx screws. Do not over tighten screws.



Take care that the rubber bumper is properly aligned between the top and bottom covers. Failure to do so will compromise the liquid protection features of the Infinea X.

INSTALLING THE BATTERY PACK

Standard and Extended Battery Installation

The Infinea X is designed to support Standard and Extended external swappable battery packs. The swappable battery pack design reduces down time of the Infinea X. Follow the steps below to install or replace your Infinea X battery pack.

1. Check that the battery-latch is in the fully open position.

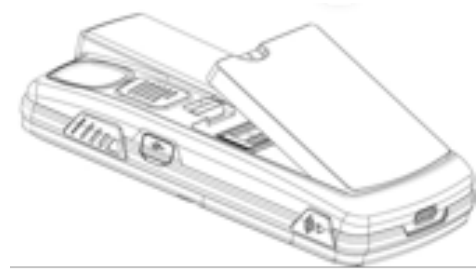

Take care not to force the battery into place if the latch is in the close/lock position.

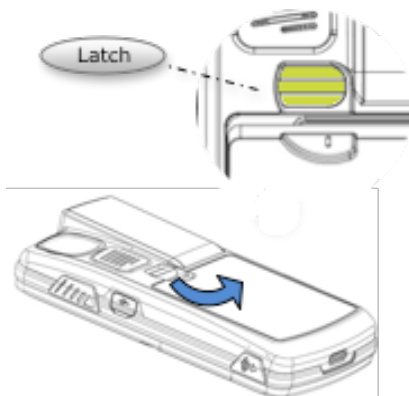

2. Lower the battery pack into place as shown in the figure on the left. The battery should sit flat when installed correctly.

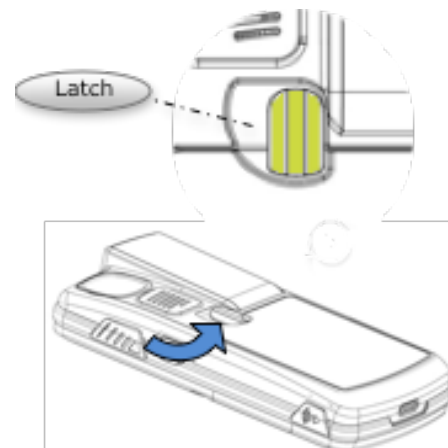

3. With slight pressure on the backside of the battery pack, rotate the latch counter-clockwise 90-degrees or until the battery is securely locked in place as shown in the figure on the right.

CHARGING YOUR INFINEA X

There are two options for charging the Infinea X:

- By wall outlet
- By replacing battery

The Infinea X supports pass through charging to the iOS device. An iPod or iPhone and Infinea X combination may be charged by attaching the Charging Cup to the bottom of the Infinea X and USB end into an AC wall adapter or by station charger. Due to charging requirements, the Infinea X and iPod or iPhone combination cannot be charged with a USB cable to a PC.

Battery Specifications

The Infinea X standard battery has a capacity of 1,900 mAh. The extended battery pack (*sold separately*) offers a capacity of 3,800 mAh.

The charge time for an empty battery to become 100% full is 3.5 hours for the standard battery and 7 hours for an extended battery pack.

Standard Battery



Extended Battery



Battery Life Status

75%-100%	LEDs are solid green upon pressing the Battery Status button.
50%-74%	LEDs flash green upon pressing the Battery Status button.
25%-49%	LEDs flash orange upon pressing the Battery Status button.
1%-24%	LEDs flash red upon pressing the Battery Status button.
1%-9%	One LED automatically flashes red to indicate emergency low battery status.

i When remaining battery capacity is below 30%, the automatic charge of the iOS device stops.

Charging Using an Electrical Outlet

1. Attach the Charging Cup to the bottom of the Infinea X.

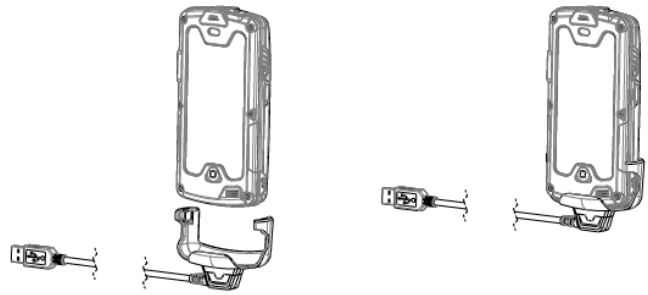

2. Plug the USB end into an AC wall adapter. (the AC adapter must support at least 2.1 amps).

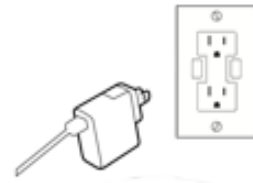

3. To check the battery life, you can press the Battery Status button and look at the status LEDs.

Refer to the table on pg. 15 to determine the battery life in relation to the LEDs.

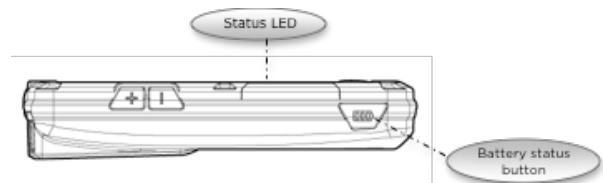

To prevent electrical damage to the Infinea X and/or battery, please use the approved Charging Cup shipped with device.

Charging the User Replaceable Battery

The multi-bay battery charger is an available accessory. Ten batteries may be charged at once.

Each battery slot has an individual LED charge indicator. A red LED indicates that charging is in progress. A green LED means the battery is fully charged. Typical full charge status takes approximately 2.5 hours for a standard capacity battery and 5 hours for an extended capacity battery.



Figure 7: Multi-bay Battery Charger



This Battery Charger is intended for use in charging only Infinite Peripherals Infinea X Standard and Extended Battery Packs. Do not use this Battery Charger with any other battery types.

Battery Disposal

Dispose used batteries according to federal law. This may include disposing them at a battery-recycling center or hazardous waste collection site.

POWERING ON YOUR INFINEA X

Dual Purpose Scan Button

The Infinea X uses a dual-purpose Scan/Power button to power on the Infinea X unit, as well as to scan barcodes. When the Infinea X is left idling for an extended period, the unit automatically goes into sleep mode to preserve the charge of the battery.

Power On

When the Infinea X is in the Off/Sleep mode, press the Scan/Power button to power on the unit. A single beep indicates the Infinea X is ready for use.

Pressing the scan button a second time will activate the scanner for normal barcode scanning.

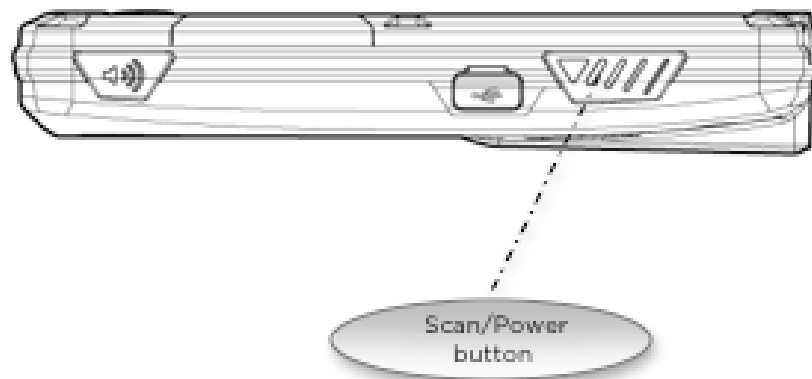

Figure 8: Scan/Power Button



Custom software must be used in order for the Infinea X to communicate with the iOS device. Please consult your reseller for this software, or contact Infinite Peripherals for recommendations on compatible software solutions.

Barcode Scanning

To scan a barcode:

1. Turn on the Infinea X by pressing the scan button.
2. Position the scan head so that the red target is aimed at the barcode, and the barcode is within the width of the red illumination cross hairs.
3. Slowly pull back the device to increase the distance between the barcode and scanner, until the scanner has read the barcode.



The Barcode Scanner uses a Class 2 Laser. Do not look or stare into the beam.

RFID

To capture RFID information:

1. Activate the Infinea X by pressing the Scan button.
2. Place the RFID tag/card over the receiver/transmitter. Keep the face of the tag/card flat with the receiver/transmitter and as close as possible.



Figure 9: RFID Antenna



Depending on the type of RFID tags/cards being used, it may be necessary for tags/cards to make direct contact with the surface where the RFID receiver/transmitter is located for proper read/write.

Audio

1. To enable front speaker on the Infinea X, momentarily press the lower right-side button. The blue LED will be off when the front speaker is enabled. The rear speaker is now disabled.
2. To enable the rear speaker on the Infinea X, momentarily press the lower right-side button. The blue LED will be lit when the rear speaker is enabled. The front speaker is now disabled.

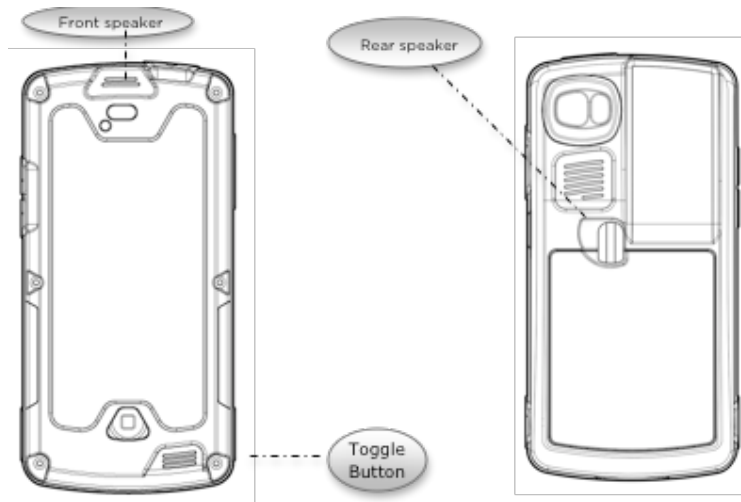

Figure 10: Speakers and Toggle Button

STATUS AND OPERATIONAL MODES

Programmable LED Status

The Infinea X provides application developers with programmable, multi-color LEDs, as shown in the figure below.

Supported Colors:

- Red
- Blue
- Green
- Orange

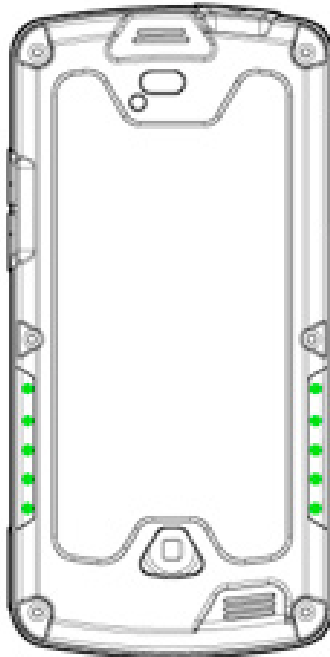

Figure 11: Programmable LED Status



For information on programming the Infinea X LEDs, refer to the SDK documentation.

Rear Speaker/Microphone Status

The Infinea X provides application developers with a programmable feature to Enable/Disable the Infinea X rear speaker and microphone.

When the speaker is enabled, a single blue LED is lit on the right side of the unit, as shown in the figure below.

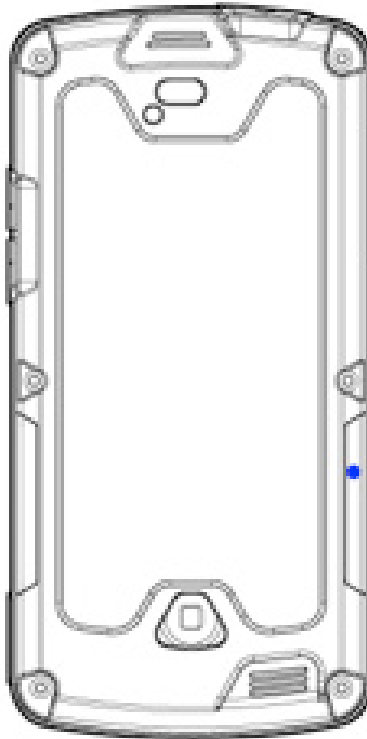

Figure 12: Speaker/Microphone Status

Manually Enable/Disable Rear Speaker

To disable the rear speaker manually, press the lower right button to toggle the rear speaker mode.

Speaker/Mic Mode	Speaker/Mic LED
Enabled	On
Disabled	Off

RESETTING YOUR INFINEA X

The Infinea X uses the Battery Status indicator button and the Scan button to perform a soft-reset without removing the iOS device. The soft-reset feature cycles the power, allowing the Infinea X to restart.



Figure 13: Reset Feature

To reset the Infinea X:

1. Press the Scan button and Battery Status indicator buttons simultaneously for about 3 seconds. The Infinea X main board resets and provide an audible “beep” as confirmation.
2. Release both buttons to allow the Infinea X to restart.

Note: *If the Infinea X does not restart, repeat the above steps.*

SYNCING YOUR INFINEA X

To sync an iPod/iPhone with iTunes through the Infinea X, connect the Infinea X to a computer using the Charging Cup, as shown in the figure below.

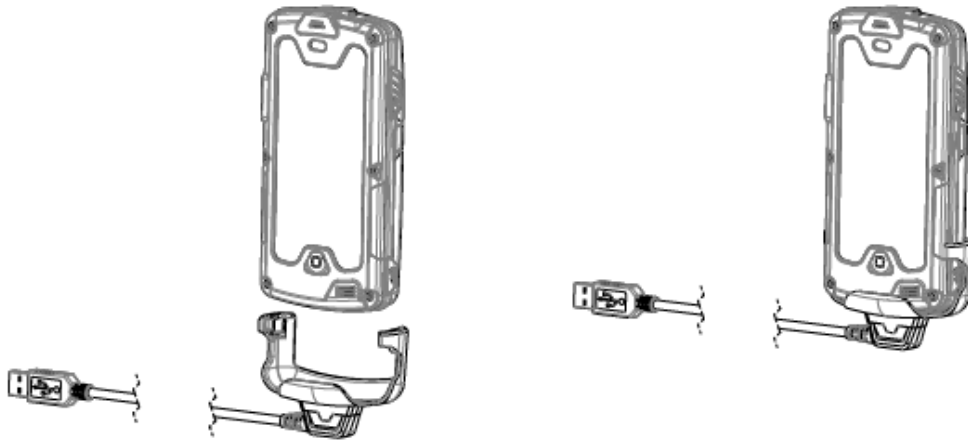

Figure 14: Sync Feature

The Infinea X should be in Sync mode. Refer to the iTunes documentation for instruction on syncing your iPod and iPhone.

To disable Sync mode, exit iTunes and then unplug the Infinea X from the Charging Cup.

If syncing feature does not function as described above, please contact your software application developer, as the sync feature may be disabled within your application.

TROUBLESHOOTING

If you are having problems not related to scanning barcodes or reading/writing RFID Tags/Cards, refer to the table below for possible causes.

Troubleshooting—General

Problem		Possible Cause
1.	iOS device will not sync to iTunes.	<ul style="list-style-type: none"> Infinea X is not configured for sync.
2.	iOS touch screen does not respond to swipe and tap gestures.	<ul style="list-style-type: none"> Top cover is not properly installed. iOS device requires power cycle.
3.	Audio playback not heard from front speakers.	<ul style="list-style-type: none"> iOS device is not connected to audio jack. Infinea X front speaker cable is damaged or disconnected.
4.	Audio playback not heard from rear speakers.	<ul style="list-style-type: none"> iOS device is not connected to audio jack. Rear speaker not powered.
5.	iOS device will not charge.	<ul style="list-style-type: none"> AC adapter may not meet charging requirements. Pass Through Sync is enabled.

Troubleshooting—Scanner

If you are having problems scanning barcodes, refer to the table below for possible causes.

Problem		Possible Cause
1.	Scanner does not turn On.	<ul style="list-style-type: none"> Infinea X battery is low. Infinea X not powered on by software. Scan engine is faulty. Charging Cup is connected to Infinea X
2.	No barcode data returned during scanning.	<ul style="list-style-type: none"> Barcode is unreadable. Infinea X battery is low. Scan engine is faulty. Software decoding incorrectly.
3.	Unable to perform multi-scanning.	<ul style="list-style-type: none"> Multi-scan mode not enabled. Software does not support multi-scans.
4.	Unable to hear scanner beep.	<ul style="list-style-type: none"> Sound mode not enabled. Infinea X battery is low.
5.	Unable to scan certain barcodes symbols.	<ul style="list-style-type: none"> Barcode type is not configured.

Troubleshooting—RFID

If you are having problems reading or writing RFID Tags/Cards, refer to the table below for possible causes.

Problem		Possible Cause
1.	RFID does not turn On.	<ul style="list-style-type: none"> • Infinea X battery is low. • Infinea X not powered on by software. • RFID reader is faulty. • Charging Cup is connected to Infinea X
2.	No/partial RFID data returned during scanning.	<ul style="list-style-type: none"> • Unreadable RFID tag/card. • Infinea X battery is low. • Faulty RFID reader. • Software decoding incorrectly.
3.	Unable to read certain RFID Tags/Cards.	<ul style="list-style-type: none"> • RFID type is not configured.



If you are having problems with your Infinea X which are not addressed by the table above, contact technical support at support@ipcmobile.com.

CLEANING YOUR INFINEA X

Precautions

The Infinea X is certified to meet IP54 Ingress Protection Marking per IEC 60529. Per the IP54 rating, the Infinea X is protected against interference with normal operation of the Infinea X sled caused by dust and splashing liquids. At no time should the Infinea X sled be completely immersed in liquid. Total submersion of the device may allow liquid to enter the unit and impair its normal function. Immersion will also void the Infinea X warranty.

The Infinea X is molded using medical-grade materials that are formulated with an anti-microbial additive. Please review the specifications for Silver Seal™ to ensure that the specifications are sufficient and appropriate for the intended use and environment. The end user should determine an appropriate cleaning procedure that complies with any facility and/or industry-specific cleaning requirements. The following information is a general cleaning guideline that should be followed to ensure the Infinea X maintains its normal operation.

Cleaning guidelines for the Infinea X

- Do NOT autoclave, machine wash, pressure-sterilize or gas-sterilize the Infinea X.
- Do NOT soak or immerse in any liquid.
- Clean the Infinea X only when the battery module is properly installed and locked into the Infinea X. This will ensure proper sealing of the Infinea X prior to introducing any solutions and/or wipes used during the cleaning process.
- Apply cleaning solutions with a soft lint-free cloth. If the solution comes in the form of a wipe, ensure the wipe is lint-free and will not scratch the plastic surfaces (especially the scan window). Excessive solution that resides in any of the waterproof membrane or gasket areas can seep into the devices and cause damage to the internal components.
- Do not touch, press or rub the display and/or covers with abrasive cleaning compounds, instruments, brushes, rough surface material or bring the display and/or covers into contact with products that could potentially scratch the display or covers.
- To clean the Infinea X screw areas, use a soft-bristled brush with approved cleaning solutions. Focus cleaning in the screw areas, ensuring that the brush is not used in areas that contain seals or gaskets.
- Do not use ammonia based, petroleum-based or acetone cleaning solutions to clean the Infinea X. Also avoid harsh solvents.
- Use the following cleaning solutions only to clean the Infinea X exterior surfaces:
 - Clorox® Bleach (10%)
 - Isopropyl Alcohol Wipes (70%)

TECHNICAL DATA

MECHANICAL	
Compatibility	iPod touch 5th and 6th generation, iPhone 5/5s/SE
Connectivity	Apple Lightning™ connector Pass-through sync via mini USB
Weight	200 g with battery (7.5 oz.)
Dimensions	148mm (L) x 72mm (W) x 31mm (H) 5.83in. (H) x 2.84in (W) x 1.22in (H)
Buttons	<ul style="list-style-type: none"> • Scan button • Battery Status button • Programmable button
Port	Mini USB for charge and sync <i>*Use of Charging Cup is recommended for charge and sync functions.</i>
ELECTRICAL	
Barcode Scanner	2D High Speed Imager (supports all major 1D and 2D barcodes)
Battery Capacity	User-replaceable rechargeable hard pack Li-ion Battery 3.7V 1900mAh
Power Consumption	Deep sleep ~20uA
Contactless Card Reader (RFID)	<p>ISO/IEC 14443 Type A/MIFARE</p> <ul style="list-style-type: none"> • MIFARE MINI • MIFARE CLASSIC-1K, MIFARE CLASSIC-4K • MIFARE ULTRALIGHT, ULTRALIGHT-C • MIFARE PLUS 2K/4K • DESFire card • FeliCa <p>ISO/IEC 14443 Type B</p> <ul style="list-style-type: none"> - Supports most cards <p>ISO/IEC 15693</p> <ul style="list-style-type: none"> - Supports most cards
Bluetooth	Bluetooth 2.0 Class 2 Distance - Up to 10m Serial Port Profile (SPP)
Indicators	<p>Visual:</p> <ul style="list-style-type: none"> • 4 programmable color LEDs (green, blue, red and orange)
	<p>Audio:</p> <ul style="list-style-type: none"> • Electromagnetic Buzzer and loudspeaker
CERTIFICATIONS	
General	CE, FCC, Apple MFi
Drop Rating	1.22m (4 ft.) IP54 rated

ENVIRONMENT	
Operating Environment	Temperature: +10°C to +40°C (<i>50°F to 104°F</i>)
	Humidity: 5 to 90% RH
Storage Environment	Temperature: -20°C to +50°C (<i>-4°F - +122°F</i>)
	Humidity: 5 to 90% RH

MECHANICAL	
Compatibility	iPod touch 5th and 6th generation, iPhone 5/5s/SE
Connectivity	Apple Lightning™ connector Pass-through sync via mini USB
Weight	200 g with battery (7.5 oz.)
Dimensions	148mm (L) x 72mm (W) x 31mm (H) 5.83in. (H) x 2.84in (W) x 1.22in (H)
Buttons	<ul style="list-style-type: none"> • Scan button • Battery Status button • Speaker front/rear toggle button
Port	Mini USB for charge and sync <i>*Use of Charging Cup is recommended for charge and sync functions.</i>
ELECTRICAL	
Barcode Scanner	2D High Speed Imager (supports all major 1D and 2D barcodes)
Battery Capacity	User-replaceable rechargeable hard pack Li-ion Battery 3.7V 1900mAh
Power Consumption	Deep sleep ~20uA
Contactless Card Reader (RFID)	ISO/IEC 14443 Type A/MIFARE <ul style="list-style-type: none"> • MIFARE MINI • MIFARE CLASSIC-1K, MIFARE CLASSIC-4K • MIFARE ULTRALIGHT, ULTRALIGHT-C • MIFARE PLUS 2K/4K • DESFire card • FeliCa ISO/IEC 14443 Type B - Supports most cards ISO/IEC 15693 - Supports most cards
Bluetooth	Bluetooth 2.0 Class 2 Distance - Up to 10m Serial Port Profile (SPP)
Indicators	Visual: <ul style="list-style-type: none"> • 4 programmable color LEDs (green, blue, red and orange)
	Audio: <ul style="list-style-type: none"> • Electromagnetic Buzzer and loudspeaker
CERTIFICATIONS	
General	CE, FCC, Apple MFi
Drop Rating	1.22m (4 ft.) IP54 rated

ENVIRONMENT	
Operating Environment	Temperature: +10°C to +40°C (<i>50°F to 104°F</i>)
	Humidity: 5 to 90% RH
Storage Environment	Temperature: -20°C to +50°C (<i>-4°F - +122°F</i>)
	Humidity: 5 to 90% RH

WARRANTY

Infinite Peripherals does not warrant, and is not responsible for, any damage to the Infinea X (“Product”) or the assembled iOS device as a result of liquid or solid particle intrusion into the Product, or damaged caused by dropping the Product with the assembled iOS device. If a material or workmanship defect arises with regard to any Infinite Peripherals’ product, and a valid claim is received within the Warranty Period, we (at our sole discretion) will (1) Repair the Product using new or refurbished parts or (2) Replace the Product with a new or refurbished Product. For purposes of this limited warranty, “refurbished” means a product or part that has been substantially returned to its original specifications. In the event of a defect, these are your exclusive remedies.

DISCLAIMER

NO WARRANTY. This technical documentation is provided as is. Furthermore, the documentation does not represent any commitment on the part of Infinite Peripherals, Inc and does not warrant that it is accurate, complete or error-free. Any use of the technical documentation is at the risk of the user. Infinite Peripherals, Inc reserves the right to make changes to specifications or other information contained within this document, without prior notice, and the reader should in all cases consult Infinite Peripherals, Inc. to determine whether any such changes have been made. Infinite Peripherals, Inc. shall not be liable for technical or editorial errors or omissions contained herein; nor for incidental or consequential damages resulting from the furnishing, performance, or use of this material. Infinite Peripherals, Inc. does not assume any product liability arising out of, or in connection with, the application or use of any product or application described herein.











PRODUCT RETURNS AND SERVICING

Visit our online support center at <http://ipcmobile.com/support/rma-support.html>. Use the link provided to create an account and gain access to our Knowledge Base and online support services. Through our online support center, you’ll be able to download files, open a Support Ticket, manage your RMAs, view your account Profile and subscribe to Alerts.

To Request an RMA

1. Create a user account in the RMA Support Portal at <http://ipcmobile.com/support/rma>
2. Login to your user account and then click Create RMA Request.
3. Read the instructions provided and complete the online request form.
4. Note the assigned RMA number and write it clearly on your shipping carton.
5. Ship your equipment back to us at the address provided.

SYMBOLS FOR USE

Symbol	Definition
	Consult Instructions for Use
	Manufacturer
	Manufacture Date
	Serial Number
	Part Number
	Waste Electrical and Electric Equipment
	Do Not Autoclave
	Do Not Incinerate
	Mark of conformity to European Union Directives
	Complies with part 15 of the FCC rules

FEDERAL COMMUNICATIONS COMMISSION

Federal Communications Commission (FCC) Statement

15.21

You are cautioned that changes or modifications not expressly approved by the part responsible for compliance could void the user's authority to operate the equipment.

15.105(b)

This equipment has been tested and found to comply with the limits for a Class B digital device, pursuant to part 15 of the FCC rules. These limits are designed to provide reasonable protection against harmful interference in a residential installation. This equipment generates, uses and can radiate radio frequency energy and, if not installed and used in accordance with the instructions, may cause harmful interference to radio communications. However, there is no guarantee that interference will not occur in a particular installation. If this equipment does cause harmful interference to radio or television reception, which can be determined by turning the equipment off and on, the user is encouraged to try to correct the interference by one or more of the following measures:

- Reorient or relocate the receiving antenna.
- Increase the separation between the equipment and receiver.
- Connect the equipment into an outlet on a circuit different from that to which the receiver is connected.
- Consult the dealer or an experienced radio/TV technician for help.

Operation is subject to the following two conditions:

1. This device may not cause interference and
2. This device must accept any interference, including interference that may cause undesired operation of the device.

FCC RF Radiation Exposure Statement

This equipment complies with FCC radiation exposure limits set forth for an uncontrolled environment. End users must follow the specific operating instructions for satisfying RF exposure compliance. This transmitter must not be co-located or operating in conjunction with any other antenna or transmitter.