

Installation Procedures

Mesh Warehouse ceiling systems are designed to be simple & fast to install.

Product List

Up-Stands (1)

2 x 2400mm Lengths
2 x 1200mm Lengths

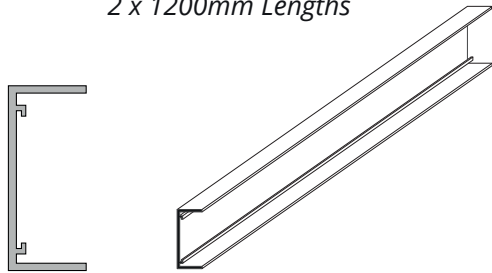

T-Bar (2)

3 x 1160mm Lengths
4 x 575mm Lengths

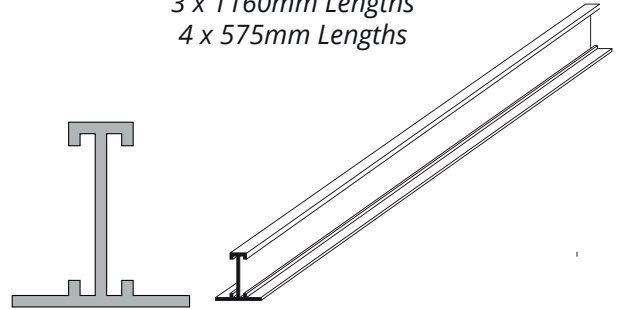

Corner Bracket (3)

x 4

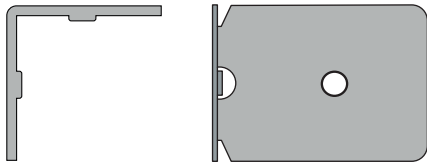

T-Bar Connector Clip (4)

x 6

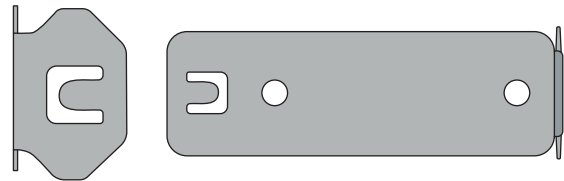

T-Bar to Up-Stand Connector Clip (5)

x 8

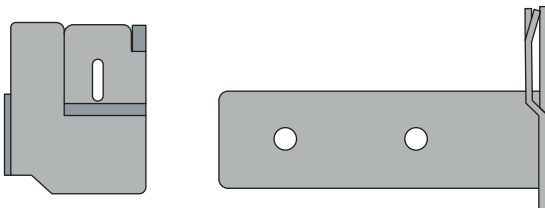

Suspension Bracket (6)

x 4

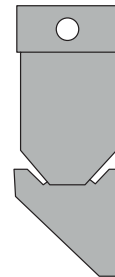

Mesh Tiles (7)

8 x 590mm x 590mm

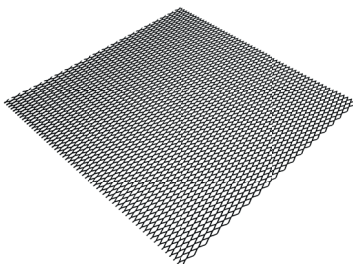

Grub Screw (9)

x 8

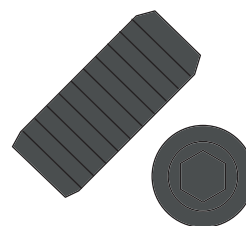

Please Note: we do not supply Tek screws or fixings to ceiling.

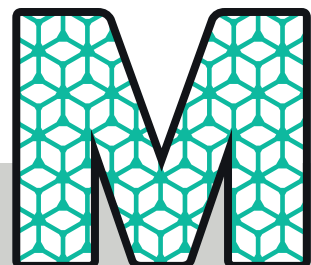

The Layout

Building the raft.

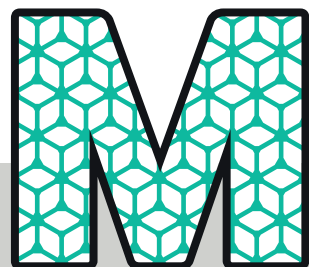
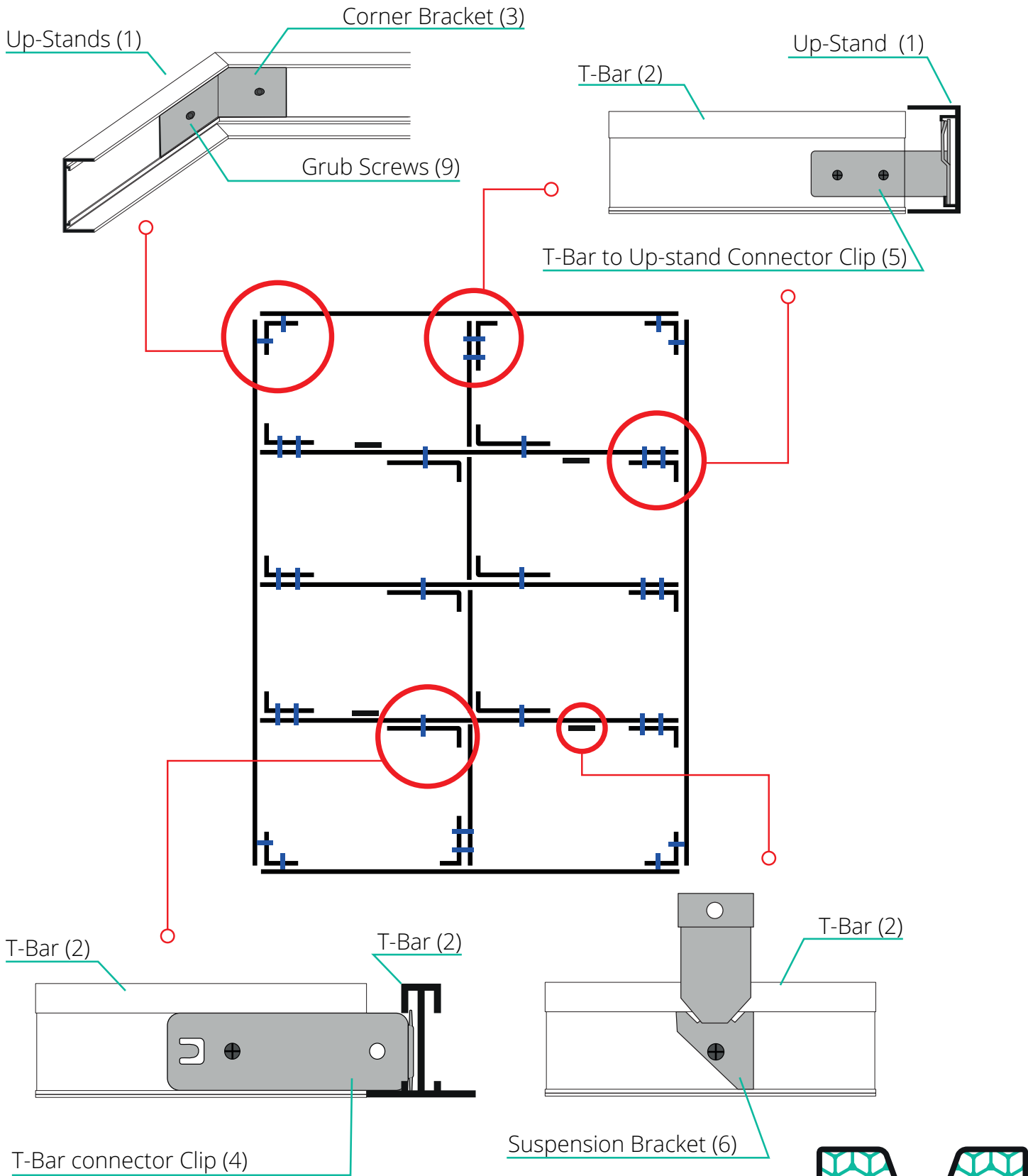

The Details

Build the inner T-Grid.

Rotate T-Grid connector Clip clockwise into up-stand retaining grooves

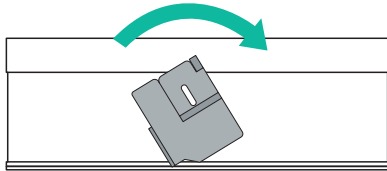

Clip will 'lock' into position

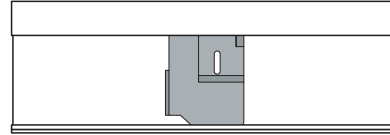

Secure T-Bar to Connector Clip with 2 screws, so that the end of the T-Bar butts up to the edge of the Up-Stand

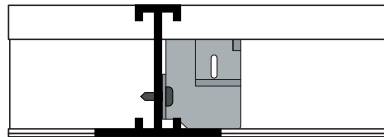

The Mesh

Inserting the Mesh Tiles

To install mesh tiles simple, lift & tilt into place once raft is suspended. Mesh Tiles **DO NOT** need fixing into place, they're designed to lay-in to the frame.

Lift & Tilt

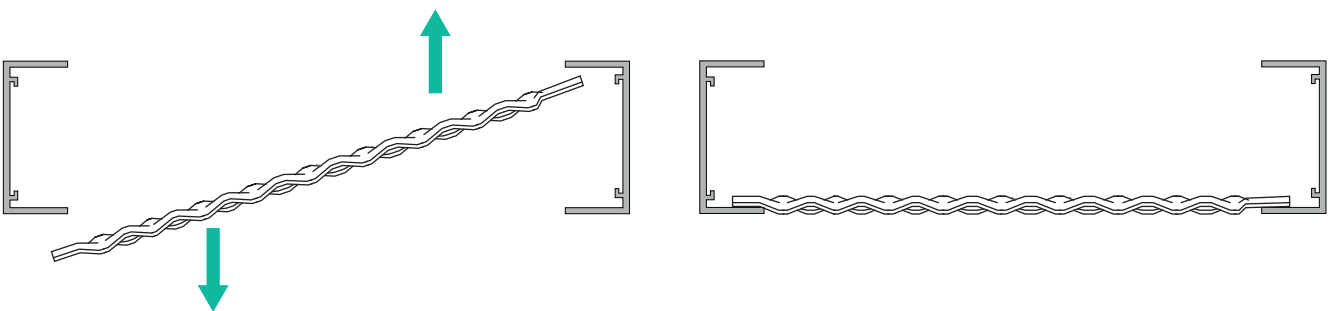

WARNING:

Mesh tiles have sharp edges, watch fingers - It's recommended to install wearing gloves

Raft is now ready.

