



eTracer-BND series

—MPPT Solar Charge Controller

User Manual



Models:
ET4415BND
ET6415BND
ET6420BND

Important Safety Instructions

Please reserve this manual for future review. This manual contains all instructions of safety, installation and operation for Maximum Power Point Tracking (MPPT) controller in eTracer-BND series ("the controller" is referred in this manual).

General Safety Information

- Read carefully all the instructions and warnings in the manual before installation.
- No user serviceable component inside controller. DO NOT disassemble or attempt to repair the controller.
- Mount the controller indoors. Avoid direct sunlight, high temperatures and do not install in locations where water can enter the controller.
- Install the controller in well ventilated places, the controller's heat sink may become very hot during operation.
- Suggested to install appropriate external fuses/breakers.
- Make sure switching off all connections with PV array and the fuse/breakers close to battery before controller installation and adjustment.
- Power connections must remain tight to avoid excessive heating from a loose connection.

Information générales sur la sécurité

- Lisez toutes les instructions et précautions dans le manuel avant l'installation.
- Il n'y a aucune pièce utilisable pour l'utilisateur à l'intérieur du contrôleur. Ne démontez pas ou n'essayez pas de réparer le contrôleur.
- Montez le contrôleur en intérieur. Évitez l'exposition des éléments et ne laissez pas d'eau entrer dans le contrôleur.
- Installez le contrôleur eTracer dans un endroit bien ventilé, le dissipateur de chaleur de l'eTracer peut devenir très chaud pendant l'utilisation.
- Installez les fusibles / coupe-circuits comme indiqué.
- Déconnectez le module solaire, le chargeur et le fusible / coupe-circuit proche de la batterie avant l'installation ou le réglage du contrôleur.
- Les connexions d'alimentation doivent rester à proximité pour éviter une chaleur excessive du fait d'une connexion trop lâche.

Contents

1 General Information.....	1
1.1 Overview	1
1.2 Characteristics.....	2
1.3 Accessories Instructions.....	4
1.4 Maximum Power Point Tracking Technology	4
1.5 Battery Charging Stage	6
2 Installation	9
2.1 General Installation Notes	9
2.2 PV Array Requirements.....	9
2.3 Mounting	12
2.4 Wiring	13
2.5 Power Up.....	18
3 LED Indication	20
4 LCD Display & Operation	21
4.1 Button operation	21
4.2 LCD Display & Operation	21
5 Protections, Troubleshooting & Maintenance	28
5.1 Protections	28
5.2 Troubleshooting.....	29
5.3 Maintenance.....	30
6 PC Software	31
7 Specifications	33
8 Disclaimer.....	35
Annex I Conversion Efficiency Curves.....	36
Annex II Dimensions.....	42

1 General Information

1.1 Overview

Appreciate you for choosing our MPPT solar charge controller, eTracer-BND series. Based on multiphase synchronous rectification technology (MSRT) and common negative design, with dual-core processor architecture and advanced MPPT control algorithm, the products in this series have the features of high response speed, high reliability, high industrial standards, etc.

With MPPT control algorithm, in any situation, products of this series can fast and accurately track out the best maximum power point (MPP) of PV array, in order to obtain the maximum solar energy in time, MSRT can guarantee very high conversion efficiency in any charge power, which sharply improves the energy efficiency of solar system. With Modbus communication protocol interface, it is convenient for customers to expand applications and monitor in various fields like telecommunication base station, household system, wilderness monitoring system, etc.

All-round electronic fault self-test function and enhanced electronic protection function could furthest avoid damages on system components resulting from installation errors or system failures.

Features:

- Advanced Maximum Power Point Tracking (MPPT) technology, with efficiency no less than 99.5%.
- High quality components, perfecting system performance, with maximum conversion efficiency of 98.7% and full load efficiency of 98%.
- MSRT, realizing high conversion efficiency in the situation of low charge power.
- Ultra-fast tracking speed and guaranteed tracking efficiency.
- Accurately recognizing and tracking of multiple power points.
- Reliable automatic limit function of maximum PV input power, ensuring no overload.
- Wide MPP operating voltage range.
- High-speed and high-powered dual-core processor architecture, improving system response speed, optimizing system performance.
- Die-cast aluminum case for heat dissipating, ensuring excellent heat

dissipation characteristic.

- 12/24/36/48VDC automatically identifying system voltage or user-defined working voltage.
- Concise human-computer interactive interface, convenient multiple combination keys, dynamically displaying system operating data and working condition.
- Support 4 charging options: Sealed, Gel, Flooded and User.
- Battery temperature compensation function.
- Real-time energy statistics function.
- With RS-485, RS-232 communication bus interface and Modbus communication protocol, it is available to meet various communication requirements in different situations.
- Available for PC monitoring and external display unit connecting like MT50 and so on, realizing real-time data checking and parameters setting.
- Support software upgrade.

1.2 Characteristics

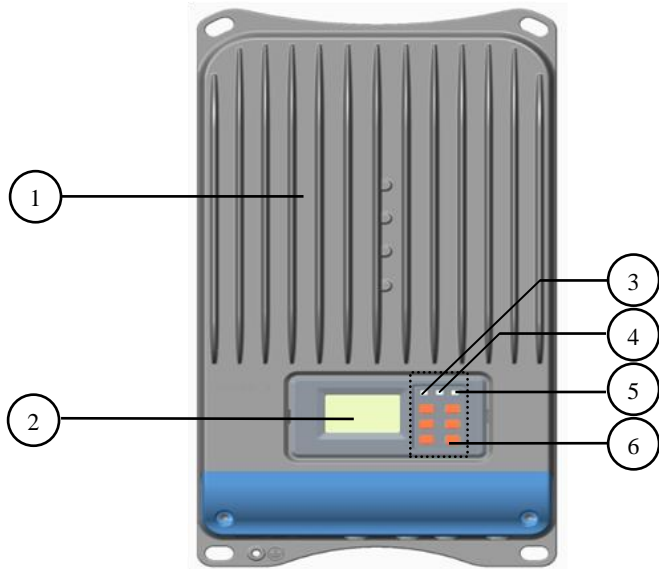

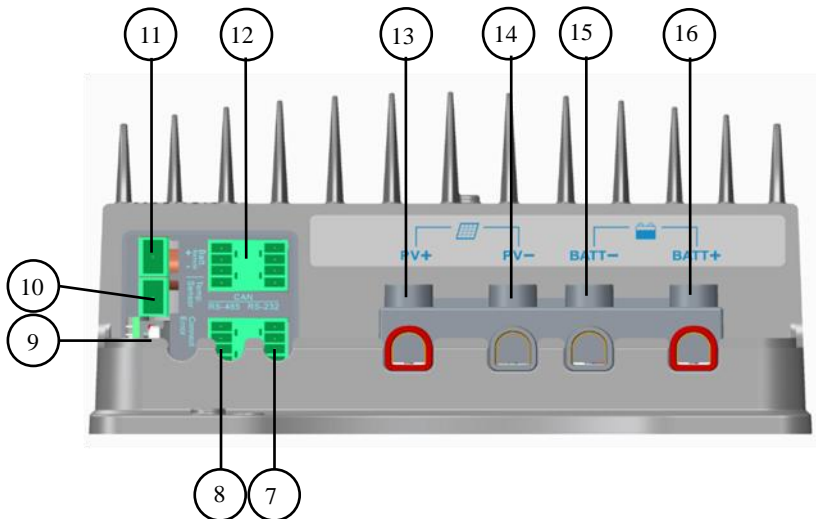

Figure 1-1 eTracer-BND Series Characteristics

Item	Name	Item	Name
1	Heat Sink	9	RTC battery (model:CR2032)
2	LCD	10	RTS Port ^②
3	Battery LED indicator	11	RBVS Port ^③
4	Charging LED indicator	12	Reserved Port
5	Fault LED indicator	13	Solar Positive Terminal(+)
6	Buttons	14	Solar Negative Terminal(-) ^④
7	RS-232 port	15	Battery Negative Terminal(-)
8	RS-485 port ^①	16	Battery Positive Terminal(+)

① Monitor controller by PC and update controller software via RS485 or RS232.

② Connect for a RTS (Remote Temperature Sensor) to remotely detect battery temperature.

③ Connect for RBVS (Remote Battery Voltage Sensor) to detect accurate battery voltage.

④ The solar controller negative and battery negative is common.

1.3 Accessories Instructions

1. Remote Temperature Sensor (Model: RTS300R10K5.08A)



Acquisition of battery temperature for undertaking temperature compensation of control parameters, the standard length of the cable is 3m (length can be customized). The RTS300R10K5.08A connects to the RTS port (10th) on the controller.



NOTE: Unplug the RTS, the temperature of battery will be set to a fixed value 25°C.

2. USB to RS-485 Converter (Model: CC-USB-RS485-150U-3.81)



The USB to RS-485 converter is used to monitor each controller on the network using Solar Station PC software and update the firmware. The length of cable is 1.5m. The CC-USB-RS485-150U-3.81 connects to the MC1.5-5.08-2L port (8th) on the controller.

3. CD (PC Software)

Solar Station PC software is used to monitor each controller on the network

1.4 Maximum Power Point Tracking Technology

Due to the nonlinear characteristics of solar array, there is a maximum energy output point (Max Power Point) on its curve. Traditional controllers, with switch charging technology and PWM charging technology, can't charge the battery at the maximum power point, so can't harvest the maximum energy available from PV array, but the solar charge controller with Maximum Power Point Tracking (MPPT) Technology can lock on the point to harvest the maximum energy and deliver it to the battery.

The MPPT algorithm of our company continuously compares and adjusts the operating points to attempt to locate the maximum power point of the array. The tracking process is fully automatic and does not need user adjustment.

As the Figure 1-2, the curve is the characteristic curve of the array, the MPPT technology will boost the battery charge current through tracking the MPP. Assuming 100% conversion efficiency of the solar system, in that way, the following formula is established:

Input power (P_{PV})= Output power (P_{Bat})



Input voltage (V_{Mpp}) *input current (I_{PV}) =Battery voltage (V_{Bat}) *battery current (I_{Bat})

Normally, the V_{Mpp} is always higher than V_{Bat} , Due to the principle of conservation of energy, the I_{Bat} is always higher than I_{PV} . The greater the discrepancy between V_{Mpp} & V_{Bat} , the greater the discrepancy between I_{PV} & I_{Bat} . The greater the discrepancy between array and battery, the bigger reduction of the conversion efficiency of the system, thus the controller's conversion efficiency is particularly important in the PV system.

Figure 1-2 is the maximum power point curve, the shaded area is charging range of traditional solar charge controller (PWM Charging Mode), it can obviously diagnose that the MPPT mode can improve the usage of the solar energy resource. According to our test, the MPPT controller can raise 20%-30% efficiency compared to the PWM controller. (Value may be fluctuant due to the influence of the ambient circumstance and energy loss.)

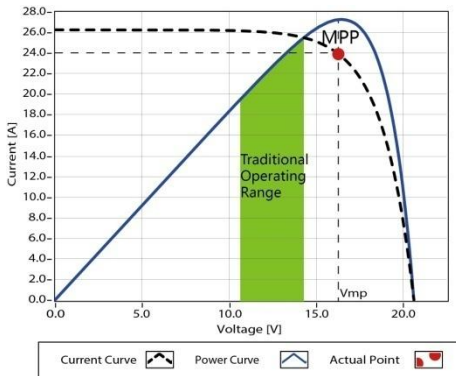

Figure 1-2 Maximum Power Point Curve

In actual application, as shading from cloud, tree and snow, the panel may appear Multi-MPP, but in actually there is only one real Maximum Power Point. As the below Figure 1-3 shows:

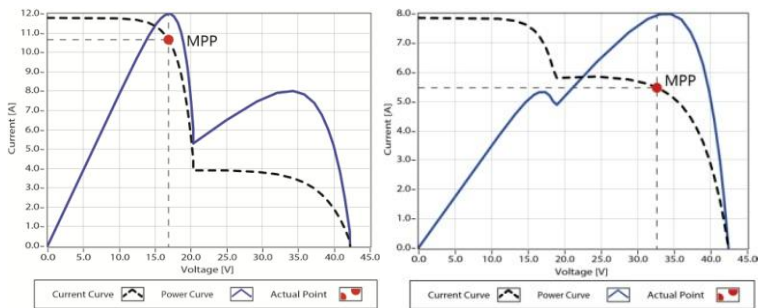

Figure 1-3 Mutil-MPP Curve

If the program works improperly after appearing Multi-MPP, the system will not work on the real max. power point, which may waste most solar energy resources and seriously affect the normal operation of the system. The typical MPPT algorithm, designed by our company, can track the real MPP quickly and accurately, improve the utilization rate of the array and avoid the waste of resources.

1.5 Battery Charging Stage

The controller has a 3 stages battery charging algorithm (Bulk Charging, Constant Charging and Float Charging) for rapid, efficient, and safe battery charging.

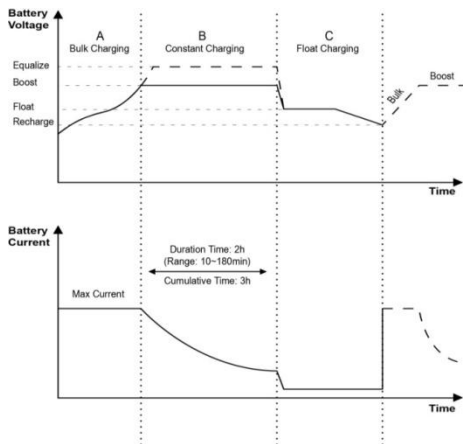

Figure 1-4 Battery charging stage

A) Bulk Charging

In this stage, the battery voltage has not yet reached constant voltage (Equalize or Boost Voltage), the controller operates in constant current mode, delivering its maximum current to the batteries (MPPT Charging).

B) Constant Charging

When the battery voltage reaches the constant voltage setpoint, the controller will start to operate in constant charging mode, this process is no longer MPPT charging, and in the meantime the charging current will drop gradually, the process is not the MPPT charging. The Constant Charging has 2 stages, equalize and boost. These two stages are not carried out constantly in a full charge process to avoid too much gas precipitation or overheating of battery.

➤ Boost Charging

The Boost stage maintain 2 hours in default, user can adjust the constant time and preset value of boost voltage according to demand.

The stage is used to prevent heating and excessive battery gassing.

➤ Equalize Charging



WARNING: Explosive Risk!

Equalizing flooded battery would produce explosive gases, so well ventilation of battery box is recommended.



CAUTION: Equipment damage!

Equalization may increase battery voltage high enough so as to damage sensitive DC loads. Verify that all load allowable input voltages are 11% greater than the equalizing charging set point voltage.



CAUTION: Equipment damage!

Over-charging and excessive gas precipitation may damage the battery plates and activate material shedding on them. Too high an equalizing charge or for too long may cause damage. Please carefully review the specific requirements of the battery used in the system.



AVERTISSEMENT : Risque d'explosion!

l'égalisation de batteries noyées peut produire des gaz explosifs, donc il est recommandé de bien ventiler le boîtier de la batterie.



ATTENTION: Dégât sur l'équipement!

L'égalisation peut augmenter la tension de la batterie jusqu'à un niveau nuisible pour les charges CC sensibles. Vérifiez que la tension d'entrée autorisées de toutes les charges disponibles sont supérieures à 11% à la tension du point d'installation de chargement d'égalisation.



ATTENTION: Dégât sur l'équipement!

Un chargement excessif et une précipitation de gaz peut endommager les plaques de la batterie et la formation de matières actives dessus. Un chargement trop fort ou une égalisation prolongée peut causer des dégâts. Inspectez soigneusement les conditions spécifiques de la batterie utilisée dans le système.

Some types of batteries benefit from equalizing charge on a regular basis, which is able to stir electrolyte, balance battery voltage and accomplish chemical reaction. Equalizing charge increases battery voltage, higher than the standard complement voltage, which gasifies the battery electrolyte. The controller will equalize the battery on the 28th each month. The constant equalization period is 0~180 minutes. If the equalization isn't accomplished in one-time, the equalization recharge time will be accumulated until the set time is finished. Equalize charge and boost charge are not carried out constantly in a full charge process to avoid too much gas precipitation or overheating of battery.

NOTE: 1) Due to the influence of ambient circumstance or load working, the battery voltage can't be steady in constant voltage, controller will accumulate and calculate the time of constant voltage working. When the accumulated time reach to 3 hours, the charging mode will turn to Float Charging.

2) If the controller time is not adjusted, the controller will equalize charge battery once every month following the inner time.

C) Float Charging

After the Constant voltage stage, the controller will reduce charging current to Float Voltage set point. This stage will have no more chemical reactions and all the charge current transforms into heat and gas at this time. Then the controller reduces the voltage to the floating stage, charging with a smaller voltage and current. It will reduce the temperature of the battery and prevent the gassing and charging the battery slightly at the same time. The purpose of Float stage is to offset the power consumption caused by self consumption and small loads in the whole system, while maintaining full battery storage capacity.

In Float charging stage, loads are able to obtain almost all power from solar panel. If loads exceed the power, the controller will no longer be able to maintain battery voltage in Float charging stage. If the battery voltage remains below the Recharge Voltage, the system will leave Float charging stage and return to Bulk charging stage.

2 Installation

2.1 General Installation Notes

- Before installation, please read through the entire installation instructions to get familiar with the installation steps.
- Be very careful when installing the batteries, especially flooded lead-acid battery. Please wear eye protection, and have fresh water available to wash and clean any contact with battery acid.
- Keep the battery away from any metal objects, which may cause short circuit of the battery.
- Explosive battery gases may come out from the battery during charging, so make sure ventilation condition is good.
- Gel, Sealed or Flooded batteries are recommended, other kinds please refer to the battery manufacturer.
- Ventilation is highly recommended if mounted in an enclosure. Never install the controller in a sealed enclosure with flooded batteries! Battery fumes from vented batteries will corrode and destroy the controller circuits.
- Loose power connections and corroded wires may result in high heat that can melt wire insulation, burn surrounding materials, or even cause fire. Ensure tight connections and use cable clamps to secure cables and prevent them from swaying in mobile applications.
- Battery connection may be wired to one battery or a bank of batteries. The following instructions refer to a singular battery, but it is implied that the battery connection can be made to either one battery or a group of batteries in a battery bank.
- Multiple same models of controllers can be installed in parallel on the same battery bank to achieve higher charging current. Each controller must have its own solar module(s).
- Select the system cables according to $5A/mm^2$ or less current density in accordance with Article 690 of the National Electrical Code, NFPA 70.

2.2 PV Array Requirements

(1)Serial connection (string) of PV modules

As the core component of PV system, Controller could be suitable for various types of PV modules and maximize converting solar energy into electrical energy. According to the open circuit voltage (V_{oc}) and the maximum power

point voltage (V_{mpp}) of the MPPT controller, the series number of different types PV modules can be calculated. The below table is for reference only.

ET4415BND/ET6415BND:

System voltage	36cell Voc<23V		48cell Voc<31V		54cell Voc<34V		60cell Voc<38V	
	MAX.	Best	MAX.	Best	MAX.	Best	MAX.	Best
12V	4	2	2	1	2	1	2	1
24V	6	3	4	2	4	2	3	2
48V	6	5	4	3	4	3	3	3

System voltage	72cell Voc<46V	96cell Voc<62V		Thin-Film Module Voc>80V
	MAX.	Best	MAX.	
12V	2	1	1	1
24V	3	2	2	1
48V	3	2	2	1

NOTE: The above parameter values are calculated under standard test conditions (STC (Standard Test Condition): Irradiance 1000W/m², Module Temperature 25°C, Air Mass1.5.)

ET6420BND:

System voltage	36cell Voc<23V		48cell Voc<31V		54cell Voc<34V		60cell Voc<38V	
	MAX.	Best	MAX.	Best	MAX.	Best	MAX.	Best
12V	4	2	2	1	2	1	2	1
24V	6	3	4	2	4	2	3	2
48V	8	5	5	4	5	3	4	3

System voltage	72cell Voc<46V	96cell Voc<62V		Thin-Film Module Voc>80V
	MAX.	Best	MAX.	
12V	2	1	1	1
24V	3	2	2	1
48V	4	3	2	2

NOTE: The above parameter values are calculated under standard test conditions (STC (Standard Test Condition): Irradiance 1000W/m², Module Temperature 25°C, Air Mass1.5.)

(2) PV array maximum power

This MPPT controller has a limiting function of charging current, the charging current will be limited within rated range, therefore, the controller will charge the battery with the rated charging power even if the input power at the PV exceeds.

The actual operation power of the PV array conforms to the conditions below:

- 1) PV array actual power \leq controller rated charge power, the controller charge battery at actual maximum power point.
- 2) PV array actual power $>$ controller rated charge power, the controller charge battery at rated power.

If the PV array higher than rated power, the charging time at rated power to battery will be longer, more energy to battery yields.



WARNING: Controller will be damaged when the PV array straight polarity and the actual operation power of the PV array is three times greater than the rated charge power!



WARNING: Controller will be damaged when the PV array reverse polarity and the actual operation power of the PV array is 1.5 times greater than the rated charge power!

When the PV array straight polarity, the actual operation of the PV array must NOT exceed three times of rated charge power; When the PV array reverse polarity, the actual operation must NOT exceed 1.5 times. For real application please refer to the table below:

Model	Rated Charge Current	Rated Charge Power	Max. PV Array Power	Max. PV open circuit voltage
ET4415BND	45A	600W/12V 1200W/24V 1800W/36V 2400W/48V	1800W/12V 3600W/24V 5400W/36V 7200W/48V	150V ^① 138V ^②
ET6415BND	60A	800W/12V 1600W/24V 2400W/36V 3200W/48V	2400W/12V 4800W/24V 7200W/36V 9600W/48V	
ET6420BND	60A	800W/12V 1600W/24V 2400W/36V 3200W/48V	2400W/12V 4800W/24V 7200W/36V 9600W/48V	190V ^① 180V ^②

①At minimum operating environment temperature

②At 25°C environment temperature

2.3 Mounting



CAUTION: When mounting the controller, ensure at least 150mm of clearance above and below the controller for proper air flow. If mounted in an enclosure, ensure good ventilation condition of the box.



WARNING: Risk of explosion!

Never install the controller with flooded batteries in a sealed enclosure! Do not install the battery in a confined area where battery gas can accumulate.



ATTENTION: Le contrôleur eTracer nécessite au moins un espace libre de 150mm au dessus et en dessous pour une circulation correcte de l'air. Une ventilation est hautement recommandée en cas d'installation dans un boitier.



AVERTISSEMENT : Risque d'explosion !

N'installez jamais le eTracer dans un boitier fermé avec des batteries noyées! N'installez pas dans un espace confiné où des gaz de batterie peuvent s'accumuler.

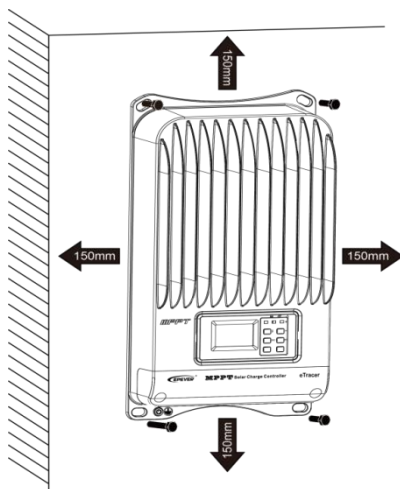
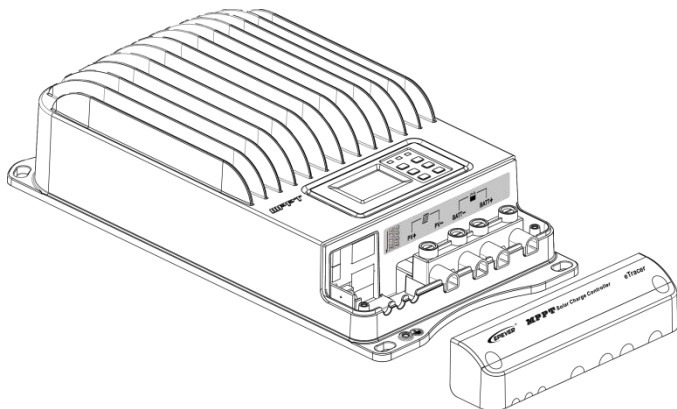

Figure 2-1 Installation Diagram

- 150mm of clearance is required around the controller for proper air flow.
- Secure the controller in place using proper mounting screws.

2.4 Wiring



※Please remove the terminal protective cover before wiring.



CAUTION: The following connection order is recommended for optimal safety.



CAUTION: Do not entangle all wiring together. Communication cable and power wires should be as far as possible to avoid interfering communication signal transmission.



CAUTION: The controller is a negative ground controller. Any negative connection of solar or battery can be earth grounded as required.



CAUTION: For mobile applications, be very certain that all wirings are connected securely. Use cable clamps to prevent cables from swaying when the vehicle is in motion. Unsecured cables create loose and resistive connections which may lead to excessive heating and/or fire.



ATTENTION: Un ordre de connexion recommandé a été prévu pour une sécurité maximum pendant l'installation.



ATTENTION: N'enchevêtrez pas tous les fils ensemble. Le câble de communication et les fils d'alimentation doivent être aussi éloignés que possible pour éviter les interférences de transmission du signal de communication.



ATTENTION: Le eTracer est un contrôleur relié à la terre sur le négative. La connexion pôle négatif du module solaire, du chargeur ou de la batterie peut être mise à la terre si nécessaire.



ATTENTION: Pour les applications mobiles, assurez-vous que tous les fils sont connectés de manière fixe. Utilisez les pinces de câble pour éviter que les câbles ne balancent. Des câbles mal fixés amènent à des connexions lâches et peut résistante qui peuvent causer un chauffage excessif et/ou un incendie.

① Remote Temperature Sensor Connection (RTS300R10K5.08A)



CAUTION: The controller will perform temperature compensation for charging parameters according to the device temperature.



CAUTION: Equipment Damage! Never place the temperature sensor inside a battery. Both the RTS300R10K5.08A and the battery will be damaged.



ATTENTION: Le contrôleur procédera à une compensation de température pour les paramètres de chargement en fonction de la température de l'appareil.



ATTENTION: Dégât sur l'équipement! Ne placez jamais le capteur de température dans une batterie. Le RTS300R10K5.08A aussi bien que la batterie seront endommagés.

The included remote temperature sensor RTS300R10K5.08A is recommended for effective temperature compensated charging. Connect the RTS300R10K5.08A to the 10th port on the controller (Check Figure 1-1). The cable standard length is 3 meters and could be customized. There is no polarity, so either wire (+ or -) can be connected to either screw terminal. No damage will result if connect the RTS300R10K5.08A to the remote battery voltage sense port, but the connection will not be recognized.

② Remote Battery Voltage Sensor Connection



CAUTION: When connecting Remote Battery Voltage Sensor, please pay attention to '+' and '-' (Check Figure 1-1).



CAUTION: Be careful when installation. Please never plug the voltage sensor wires into to the RTS300R10K5.08A terminals (10th Port). This will cause an alarm or damage the controller.



ATTENTION: Lorsque le capteur de tension de la batterie distante, soyez attentif au « + » et a « - » (voir illustration 1-1).



ATTENTION: Soyez attentif lors de l'installation. Ne branchez jamais les fils du capteur de tension sur les terminaux du RTS300R10K5.08A (10^e Port). Cela causera une alarme ou des dégâts sur le contrôleur.

The voltage at the battery terminals on the controller may differ slightly from the real battery voltage due to connection and cable resistance. The remote battery voltage sensor will enable the controller to detect the battery voltage more exactly and avoid voltage deviation. The battery voltage sensor connection is not required to operate the controller, but it is recommended for the best performance.

The voltage sensor wires should be cut into the required length. The wire size can range from 0.25 to 1.0 mm² (24 to 16 AWG). Maximum length is 3m. Connect the remote battery voltage sensor wires to the 11th port on the controller (Check Figure 1-1). A twin-cord cable is recommended but not required.

Please be careful to spot the '+' and '-' when connecting. No damage will result if the polarity is reversed, but the controller can't read a reversed sensor voltage. Plugging the voltage sensor wires into to the RTS300R10K5.08A terminals (10th Port) will cause an alarm or damage the controller.

③ Communicate Connection



WARNING: Shock Hazard!

There should not any communication cables and power lines intertwined. Separate them as far as possible to void electric shock.



AVERTISSEMENT : Risque d'électrochoc!

Il ne doit y avoir aucun mélange entre les câbles de communication et les lignes d'alimentation. Séparez-les avec une distance aussi grande que possible pour éviter un électrochoc.

There are two kinds of communication: RS-232 and RS-485. Please use matching communication cables and make sure the cables are connected firmly during data transmitting: the below features are supported with communication interface:

Monitor each controller on the network using Solar Station PC software; update the firmware.

RS-232, RS-485 Connection

The controller is a standard 3.81-4P port. Check Figure 1-1 for the port location. The RS-232 port is 7th port and the RS-485 port is 8th port on the controller.

④ Power Wires Connection

➤ PV Wire Size

Since PV array output can vary due to the PV module size, connection method or sunlight angle, the minimum wire size can be calculated by the I_{SC} of PV array. Please refer to the value of I_{SC} in PV module specification. When the PV modules connect in series, the I_{SC} is equal to the PV module's I_{SC} . When the PV modules connect in parallel, the I_{SC} is equal to the sum of PV module's I_{SC} . The I_{SC} of PV array must not exceed the maximum PV input current, please refer to the table as below:

Model	Max. PV input current	Max. PV wire size
ET4415BND	45A	16mm ² /6AWG
ET6415BND	60A	16mm ² /5AWG
ET6420BND	60A	16mm ² /5AWG

NOTE: When the PV modules connect in series, the open circuit voltage of the PV array must not exceed 138V (ET4415BND; ET6415BND) /180V (ET6420BND) under the 25°C condition.

➤ Battery Wire Size

The battery wire size must conform to the rated current, the reference size as below:

Model	Rated charge current	Battery wire size
ET4415BND	45A	16mm ² /6AWG
ET6415BND	60A	16mm ² /5AWG
ET6420BND	60A	16mm ² /5AWG

NOTE: The wire size is only for reference. If there is a long distance between the PV array and the controller or between the controller and the battery, larger wires can be used to reduce the voltage drop and improve performance.

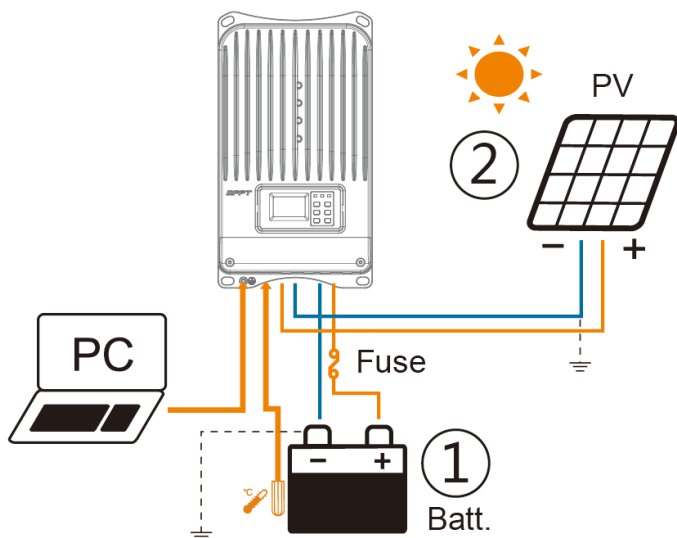

Figure 2-1 Wiring Diagram

➤ Battery Connection

Connecting a fuse in series through battery positive (+) in the circuit and the battery circuit fuse must be 1.25 to 2 times to the rated current. Keep OFF before connection. Connect battery positive (+) and negative (-) to battery terminals on the controller in the figure 1-1. Please pay much attention to '+' and '-'.

➤ Solar Module(s) Connection

Connecting a breaker in series in the solar circuit is recommended, and the breaker must be 1.25 to 2 times of the rated current. Keep OFF before connection. Connect solar positive (+) and negative (-) to solar terminals on the controller in the figure 1-1. Please pay much attention to '+' and '-'. Solar array short circuit protection and the reversed polarity connection will trigger automatically.



WARNING: Risk of electric shock!

Use fuses or breakers in solar and battery circuits is recommended, and make them keep OFF state before connection.



WARNING: Risk of electric shock!

Exercise caution when handling solar wiring. The solar PV array can produce open-circuit voltages in excess of 150 V when in sunlight. Pay more attention to it.



WARNING: Risk of explosion or fire!

Never short circuit battery positive (+) and negative (-) or cables. Pay more attention to it



AVERTISSEMENT : Risque d'électrochoc!

L'utilisation de fusibles ou coupe-circuits dans le module solaire, le chargeur et les circuits de la batterie est recommandée, ils doivent être tenus en position éteinte avant la connexion.



AVERTISSEMENT : Risque d'électrochoc!

Faites attention lors de la manipulation des connexions solaires. La matrice PV solaire peut produire des tensions supérieures à 150V, à la lumière du soleil. Soyez particulièrement attentif à cela.



AVERTISSEMENT : Risque d'explosion ou d'incendie!

Ne court-circuitez jamais les pôles positifs (+) et négatifs (-) de la batterie ou les câbles. Soyez particulièrement attentif à cela.

2.5 Power Up





CAUTION: The controller is only powered by battery, so it will not work when connected only to solar input.



REMARQUE : Le contrôleur n'est alimenté que par la batterie, donc il ne fonctionnera que lorsque branché sur l'alimentation solaire.

- Before switching on, recheck the step of ①~④ and make sure all wirings correct, especially ④ connected with battery and PV array.
- Turn on the battery Fuse firstly. Observe if battery indicator light and startup interface work fine or not (Refer to section 4). Always connect the battery firstly, in order to allow the controller to recognize the system voltage.
- After battery works fine with power on, switch on the breaker of PV array. With enough sunlight, the charging LED will blink and the controller will begin charging.
- If the battery LED error exists or LCD interface alarms, refer to section 5 for troubleshooting. When disconnecting the system, the order will be reserved.





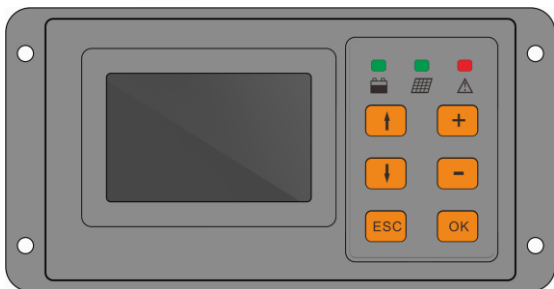

3 LED Indication

LED Indication	Color	Indicator	Status
 Charging LED	Green	flash	Charging
	Green	OFF	No charging
 Battery LED	Green	on solid	Normal
	Green	Slowly Flashing	Full
	Orange	on solid	Under voltage warning
	Red	on solid	Low voltage disconnect
	Red	flash	Battery over temperature
	Green	fast flash	High volt disconnect
 Fault LED	Red	OFF	Normal
	Red	flash	Current abnormal Charging overcurrent PV overvoltage
Charging(green) and battery indicator (Red) flashing simultaneously			System voltage error
Charging(green) and battery indicator (Orange) flashing simultaneously			Controller over temperature

4 LCD Display & Operation



4.1 Button operation

Button	Introduction
	Enter corresponding interface Save the data
	Return main menu in any monitoring interface Cancel the operation
 	Move inverse cursor Browse the parameters
 	Modify the value Set the period of log

4.2 LCD Display & Operation



➤ Rated Info

Rated Para Rat.Volt 48.0V Chrg.Cur 60.0A
--

Rated info of the controller will be displayed. Monitor interface will be switched after 3 seconds.

➤ Main Menu

Press  button to return main menu in any monitoring interface.
There are 8 interfaces for monitoring, as shown in the below picture.

Press   button to move inverse cursor among 8 menus.

Press **OK** to enter corresponding interface.

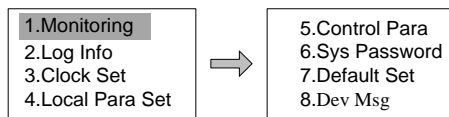

➤ Monitor

There are 9 interfaces for monitoring, as shown below:

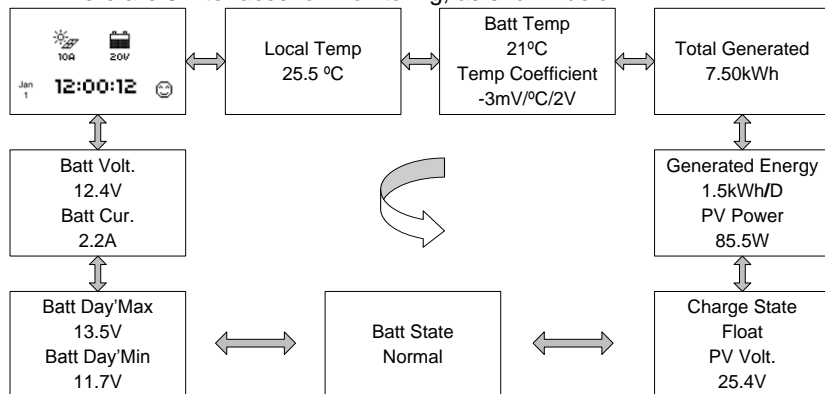

Press **OK** to enter the monitoring interface when the inverse cursor point to **monitor** item.

The parameters in monitoring interface are only for browse.

Press **↑** **↓** button to browse the parameters interfaces in turns. There are 5 battery status: Normal, UVW(Under voltage warning), LVD(Low voltage disconnect), Over Voltage, Over Temperature and 4 charging stages: no charging, equalized, boost, float.

Log Info

There are two items of log record as shown blew.

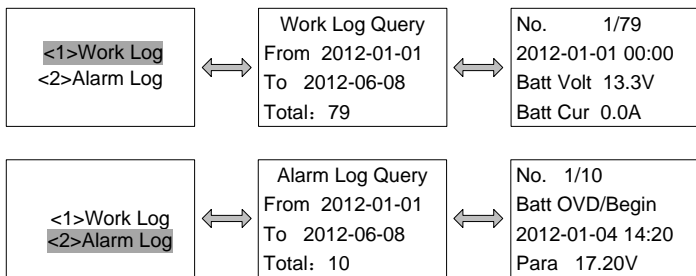

Press **OK** to enter the **Log Info** interface when the inverse cursor point to item. Press **ESC** button to exit. Work Log and Alarm Log could be browsed in this interface, the operation is as follows:

Press **OK** to enter the **Work Log** or **Alarm Log** interface respectively when the item is chosen in inverse. Press **OK** again to enter the Edit Mode. Use **↑** or **↓** button to move the cursor between the time parameters and data bit. Use **+** **-** button to modify the value and set the period of log for browse. When the period is set, press **OK** to enter the corresponding details. Log Number, time, the voltage and current of battery are included in every work log item and are shown in the Work Log interface.

Warning event sequence number, warning event, start or end time, the fault status and values are all included in every alarm Log item and are shown in the Alarm Log interface.

➤ Clock Set

The interface of Clock Set is shown as follow:

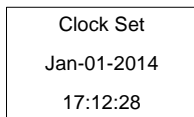

Press **OK** to enter the Clock Set interface when the inverse cursor point to **Clock Set** item. Press **ESC** button to exit.

Date and Time can be adjusted in this interface. Press **OK** and input the 6 digit user password and then Date and Time could be adjusted. The format of date is YYYY-MM-DD; the one of time is HH-MM-SS. When the set is over, press

OK to save or press **ESC** button to cancel. “Save success!” will be promoted if adjusted and save operated successfully.

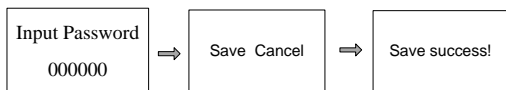

NOTE: The log after the current time will be erased when the clock have be adjusted.

➤ **Device Parameter**

There are 2 interfaces about device parameter as shown blew:

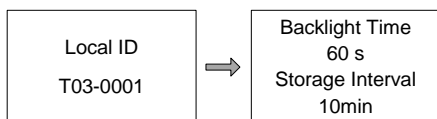

Press **OK** to enter the Device Parameter interface when the inverse cursor point to **Device Para** item. Press **ESC** button to exit. You should input the user password (see above) before setting the parameters.

The first interface shows the 4-digit controller’s ID in networking and keeps the ID number unique in the networking or PC software or other device(s) couldn’t search it.

The 2nd interface shows the backlight time. The range is from 1 to 90 seconds (60seconds default). “-” means that the backlight is never off. The interval log is from 1 to 30 minutes (10minutes default).

➤ **Control Parameter**

Press **OK** to enter the Device Parameter interface when the inverse cursor point to **Control Para** item. Press **ESC** button to exit. There are 9 interfaces for ‘Control Parameter’ as shown below.

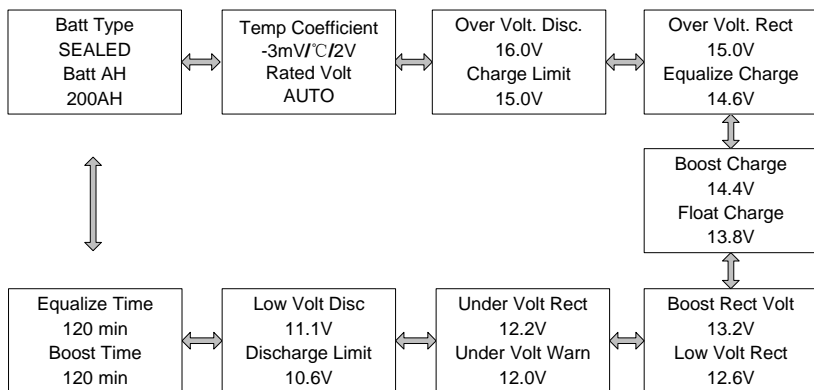

You should input the user password (see above) before setting the parameters. In setting mode, all the parameters can be modified. And will immediately effect when saved. The detail and value range of control parameter are shown in the tables below:

Battery Charging Setting

Battery Type	Note
Sealed (Default)	Constant value
GEL	Constant value
Flooded	Constant value
User	Defined by user

Others

Parameter	Default value	Range
Battery capacity	200Ah	1~9999Ah
Temperature compensate coefficient	-3mV/°C/2V	-9~0 mV/°C/2V
Rated system voltage	Auto	12/24/36/48VDC Auto

Battery Control Parameters

All the coefficient is referred to 25°C, and twice in 24V system rate, triple in 36Vsystem rate and quadruple in 48Vsystem rate.

Battery Type	Sealed	Gel	Flooded	User
High Volt Disconnect	16.0V	16.0V	16.0V	9~17V
Charging limit voltage	15.0V	15.0V	15.0V	9~17V
Over Voltage Reconnect	15.0V	15.0V	15.0V	9~17V
Equalization voltage	14.6V	—	14.8V	9~17V
Boost voltage	14.4V	14.2V	14.6V	9~17V
Float voltage	13.8V	13.8V	13.8V	9~17V
Boost return voltage	13.2V	13.2V	13.2V	9~17V
Low voltage reconnect	12.6V	12.6V	12.6V	9~17V
Under voltage recover	12.2V	12.2V	12.2V	9~17V
Under voltage warning	12.0V	12.0V	12.0V	9~17V
Low voltage disconnect	11.1V	11.1V	11.1V	9~17V
Discharging limits voltage	10.6V	10.6V	10.6V	9~17V
Equalize duration	120min	—	120min	0~180min
Boost duration	120min	120min	120min	10~180min

NOTE:

1) When the battery type is sealed, gel, flooded, the adjusting range of equalize duration is 0 to180min and boost duration is 10 to180min.

2) The following rules must be observed when modify the parameters value in user battery type (factory default value is the same as sealed type)

a. High Volt Disconnect > Charging Limit Voltage ≥ Equalization Voltage ≥ Boost Voltage ≥ Float Voltage > Boost Return Voltage;

b. High Volt Disconnect > Over Voltage Reconnect;

c. Low Voltage Reconnect > Low Voltage Disconnect ≥ Charging Limit Voltage;

d. Under Voltage Recover > Under Voltage Warning ≥ Charging Limit Voltage;

e. Boost Return Voltage > Low Voltage Reconnect;

➤ Password

```
Sys Password
Old PSW 000000
New PSW 000000
```

Press **OK** to enter the **Sys Password** interface when the inverse cursor points to Sys Password item. Press **ESC** button to exit.

NOTE: The factory default password is “000000”.

➤ Default Set

```
Default Set
No Yes
Clr Log Record
Retain clear
```

Under the main menu interface, when the inverse cursor points to restore the default option, press the **OK** button to enter to restore the default interface and clear all logs including work log and alarm Log.

NOTE: All parameters will be set to factory default and couldn't be recovery.

➤ Device Message

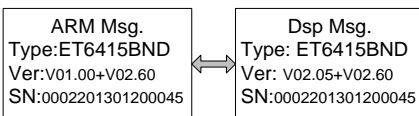

Under the main menu interface, when the inverse cursor to the **Dev Msg**, press **OK** button to enter to Device Info interface.

The Model, software and hardware version and SN number are shown in this interface.

5 Protections, Troubleshooting & Maintenance

5.1 Protections

- PV Over Current

The controller will limit charge power in rated charge power. An over-sized PV array will not operate at maximum power point.

- PV Short Circuit

When PV short circuit occurs, the controller will stop charging. Clear it to resume normal operation.



WARNING: The controller of ET6420BND may be damaged, when PV input is short circuit on high-power.

- PV Reverse Polarity

Fully protection against PV reverse polarity, no damage to the controller will result. Correct the miswire to resume normal operation.



WARNING: Controller will be damaged when the PV array reverse polarity and the actual operation power of the PV array is 1.5 times greater than the rated charge power!

- Battery Reverse Polarity

Fully protection against battery reverse polarity, no damage to the controller will result. Correct the miswire to resume normal operation.

- Battery Over voltage

When battery voltage reaches to the voltage set point of Over Voltage Disconnect Voltage, the controller will stop charging the battery to protect the battery overcharge to break down.

- Battery Over discharge

When battery voltage reaches to the voltage set point of Low Voltage Disconnect Voltage, the controller will stop discharging the battery to protect the battery over discharged to break down.

- Battery Overheating

The controller detects the battery temperature through the external temperature sensor. If the battery temperature exceeds 65°C, the controller will automatically start the overheating protection to stop working and recover below 50 °C.

- Damaged Remote Temperature Sensor

If the temperature sensor is short-circuited or damaged, the controller will be charging or discharging at the default temperature 25°C to prevent the battery damaged from overcharging or over discharged.

- Controller Overheating

If the temperature of the controller heat sinks exceeds 85°C, the controller will automatically start the overheating protection and recover below 75°C.

- High Voltage Transients

PV is protected against small high voltage surge. In lightning prone areas, additional external suppression is recommended.



CAUTION: Faults will be cleared every day, so the faults which aren't caused by hardware can be solved intelligently.

5.2 Troubleshooting

Faults	Possible reasons	Troubleshooting
Charging LED indicator off during daytime when sunshine falls on solar modules properly	PV array disconnection	Confirm that PV and battery wire connections are correct and tight
Battery LED indicator green fast blink and LCD displaying 'OVD'	Battery voltage is larger than over voltage disconnect voltage (OVD)	Check if battery voltage too high, and disconnect solar modules.
Fault LED indicator blink, LCD displaying 'Over Volt'	Solar modular output is too high	Check solar component parameters matching; the controller will disconnect the input if the voltage is over 150V and will Recovery below 145V
Fault LED indicator blink, LCD displaying 'Over Temp'	Heat sinks operational temperature is quite high to 85 °C or above	The controller will automatically stop working. When the temperature is below 75 °C, the controller will resume to work
Cannot connect to the controller via RS-485 or RS-232	RS-485 serial baud rate setting error or serial-USB adapter incorrect configuration	Check serial baud rate is set to 115200bps or not and choose the right COM port; If using a serial-USB adapter,

		verify that the adapter software is installed and a serial COM port has been mapped
--	--	---

5.3 Maintenance

The following inspections and maintenance tasks are recommended at least two times per year for best controller performance.

- Make sure controller firmly installed in a clean and dry ambient.
- Make sure no block on air-flow around the controller. Clear up any dirt and fragments on radiator.
- Check all the naked wires to make sure insulation is not damaged for serious solarization, frictional wear, dryness, insects or rats etc. Repair or replace some wires if necessary.
- Tighten all the terminals. Inspect for loose, broken, or burnt wire connections.
- Check and confirm that LED or LCD is consistent with required. Pay attention to any troubleshooting or error indication .Take necessary corrective action.
- Confirm that all the system components are ground connected tightly and correctly.
- Confirm that all the terminals have no corrosion, insulation damaged, high temperature or burnt/discolored sign, tighten terminal screws to the suggested torque.
- Check for dirt, nesting insects and corrosion. If so, clear up in time.
- Check and confirm that lightning arrester is in good condition. Replace a new one in time to avoid damaging of the controller and even other equipments.



WARNING: Risk of electric shock!

Make sure that all the power is turned off before above operations, and then follow the corresponding inspections and operations.

6 PC Software

The controller can be connected to a common PC monitoring software by supporting USB communication cable developed by the EPSolar company. Monitoring software remote single or more controllers to modify the parameters and others in the PV system management (username: administrator, password: 111111 as default). See the specific instructions related software user guide. Software interfaces are shown below:

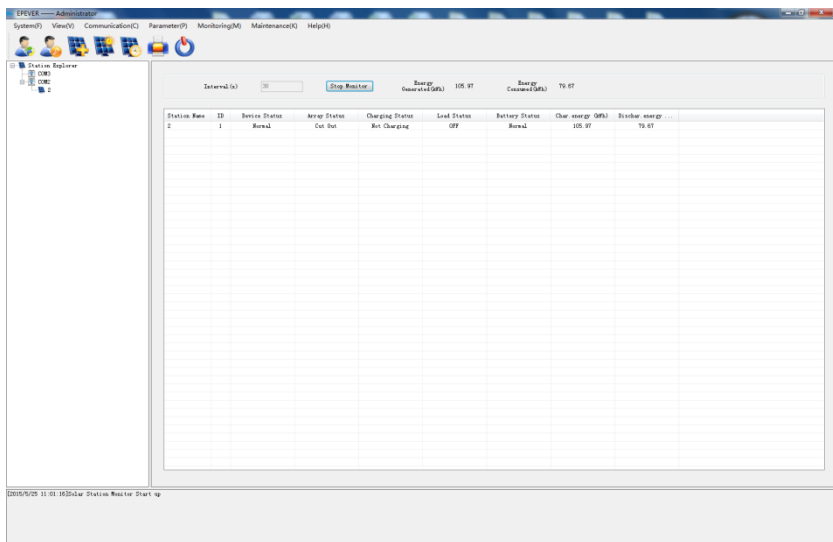

Figure6-1 Globe Monitoring

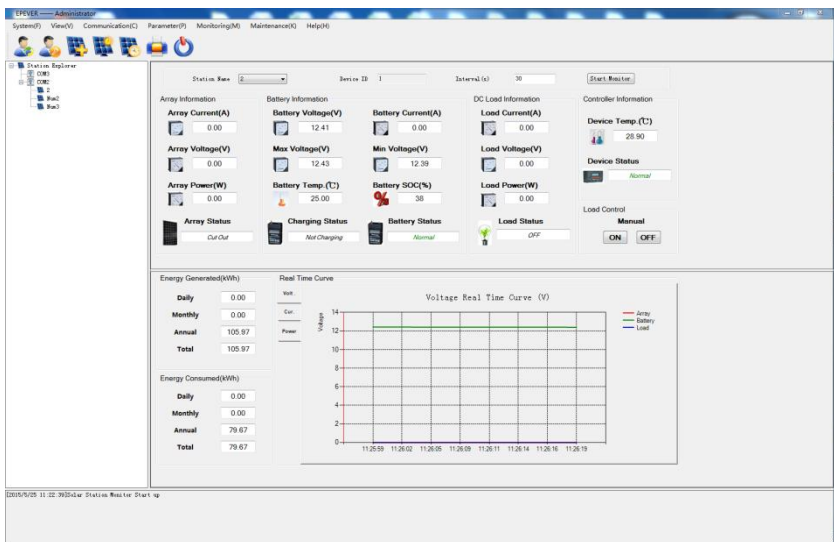

Figure6-2 Real Time Monitoring

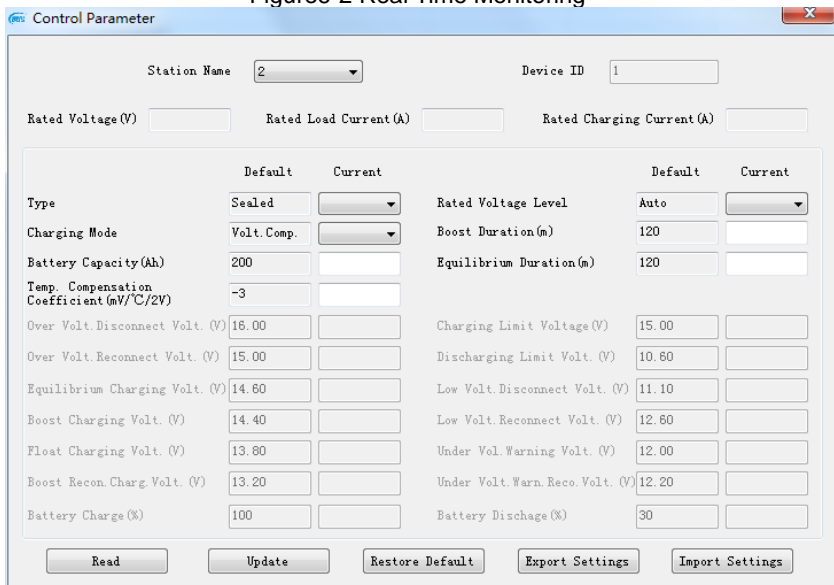

Figure6-3 Control Parameter

7 Specifications

Electrical Parameters

Item	ET4415BND	ET6415BND	ET6420BND
Nominal System Voltage	12/24/36/48VDC Auto		
Nominal Battery Current	45A	60A	
Battery Input Voltage Range	8V~68V		
Max. PV open circuit voltage	150V ^① /138V ^②		190V ^① /180V ^②
MPP Voltage Range	(V _{BAT} ※+2V)~108V ^③		(V _{BAT} +2V)~144V ^③
Maximum Input Power	600W/12V 1200W/24V 1800W/36V 2400W/48V	800W/12V 1600W/24V 2400W/36V 3200W/48V	
Self Consumption	1.4W~2.6W		
Grounding	Common Negative		

① At minimum operating environment temperature.

② At 25°C environment temperature.

③ Max. PV open circuit voltage must never exceed 138V under 25°C conditions.

※ Battery voltage

Environmental Parameters

Environmental	Parameter
LCD temperature range	-20°C ~ +70°C
Ambient temperature range*	-25°C ~ +55°C
Storage temperature range	-30°C ~ +85°C
Humidity range	≤95%, N.C.
Enclosure	IP20
Altitude	< 5000 m (Derate to operate according to IEC60146 at a height exceeding 1000 m)

* Please operate controller at permitted ambient temperature. If over permissible range, please derate capacity in service.

Mechanical Parameters

Mechanical	ET4415BND	ET6415BND	ET6420BND
L x W x H	398.6 x208 x107mm	449.1 x208 x107mm	
Mounting Hole	Φ10		
Terminal	2AWG(35mm ²)		
Net Weight	4.3kg	5.5kg	5.5kg

8 Disclaimer

This warranty does not apply under the following conditions:

- Damage from improper use or use in an unsuitable environment.
- PV or load current, voltage or power exceeding the rated value of controller.
- The controller is working temperature exceed the limit working environment temperature.
- User disassembly or attempted repair the controller without permission.
- The controller is damaged due to natural elements such as lightning.
- The controller is damaged during transportation and shipment.

Annex I Conversion Efficiency Curves

Illumination Intensity: 1000W/m²

Temperature: 25°C

Test model: ET4415BND

1. Solar MPPT Voltage(36V, 54V, 72V) / System Voltage(12V)

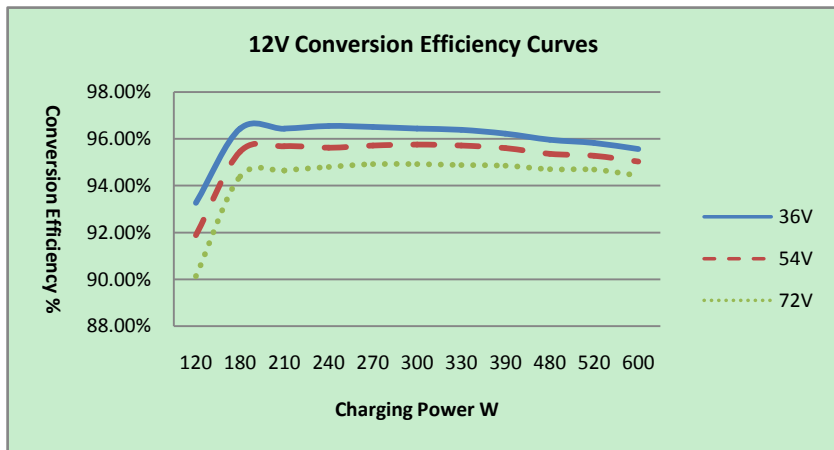

2. Solar MPPT Voltage(36V, 54V, 72V) / System Voltage(24V)

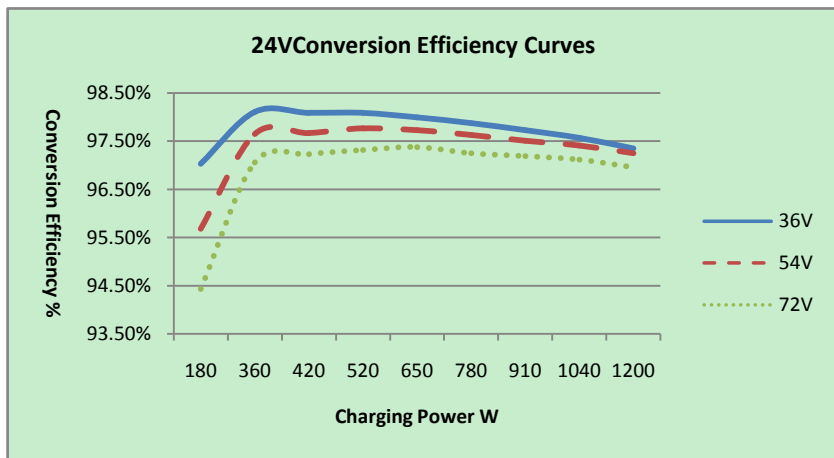

3. Solar MPPT Voltage(54V, 72V, 90V) / System Voltage(36V)

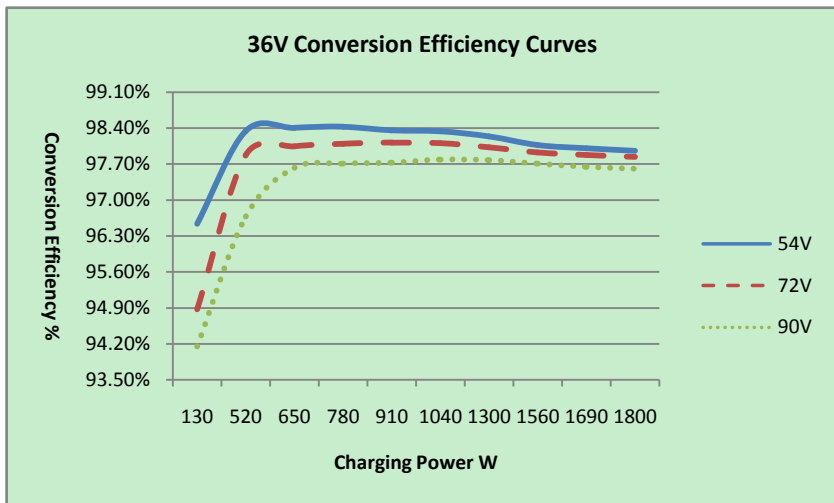

4. Solar MPPT Voltage(72V, 90V, 108V) / System Voltage(48V)

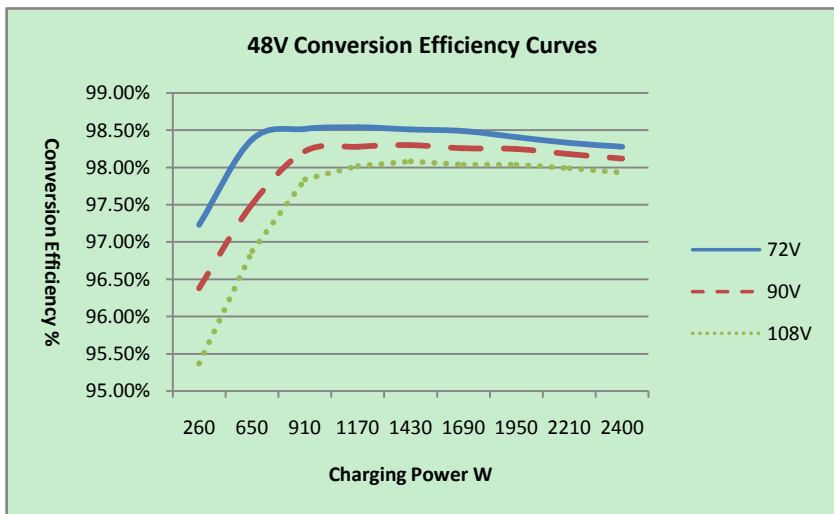

Test model: ET6415BND

1. Solar MPPT Voltage(36V, 54V, 72V) / System Voltage(12V)

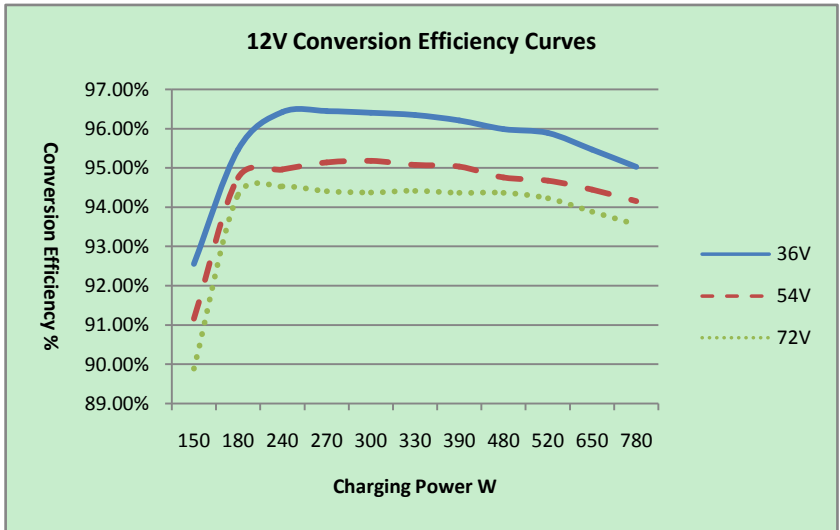

2. Solar MPPT Voltage(36V, 54V, 72V) / System Voltage(24V)

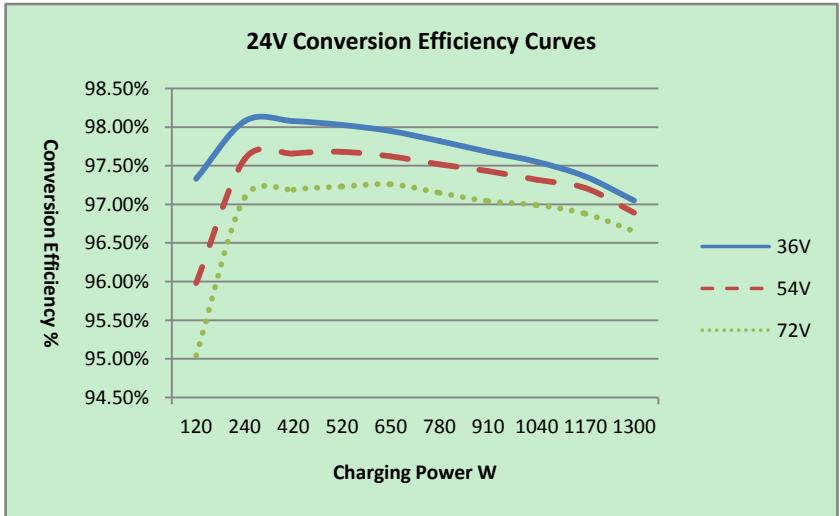

3. Solar MPPT Voltage(54V, 72V, 90V) / System Voltage(36V)

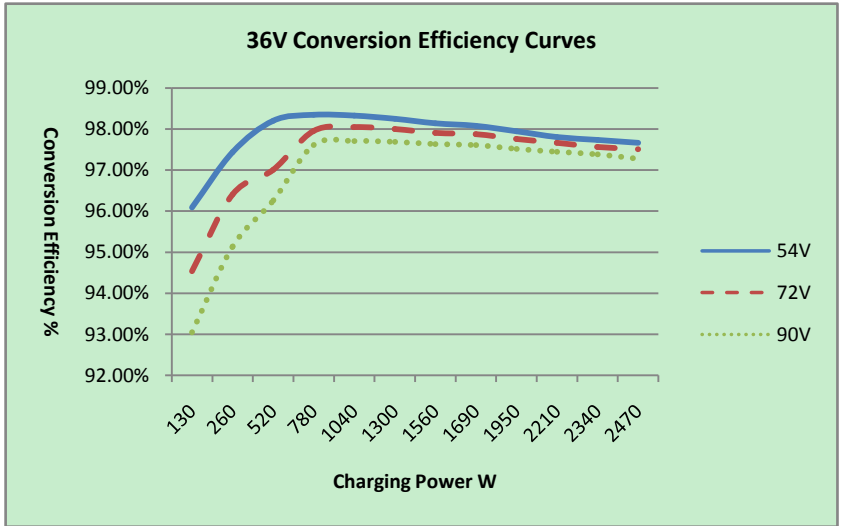

4. Solar MPPT Voltage(72V, 90V, 108V) / System Voltage(48V)

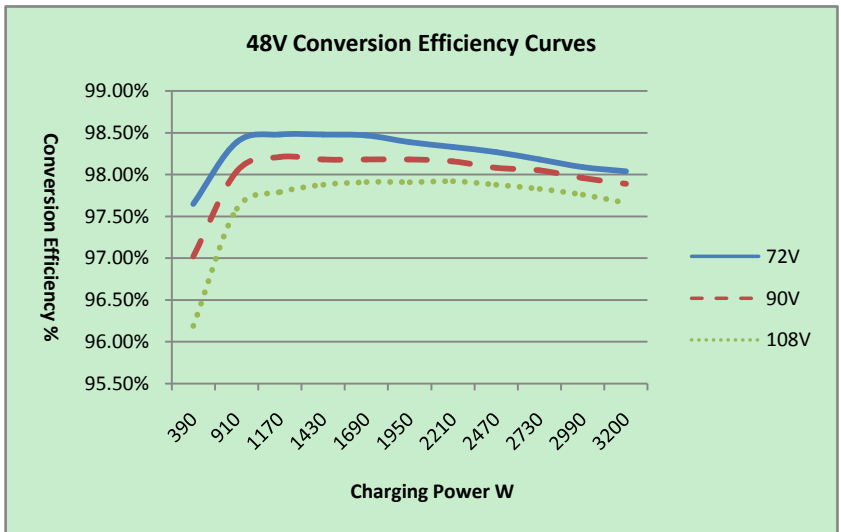

Test model: ET6420BND

1. Solar MPPT Voltage(36V, 54V, 72V) / System Voltage(12V)

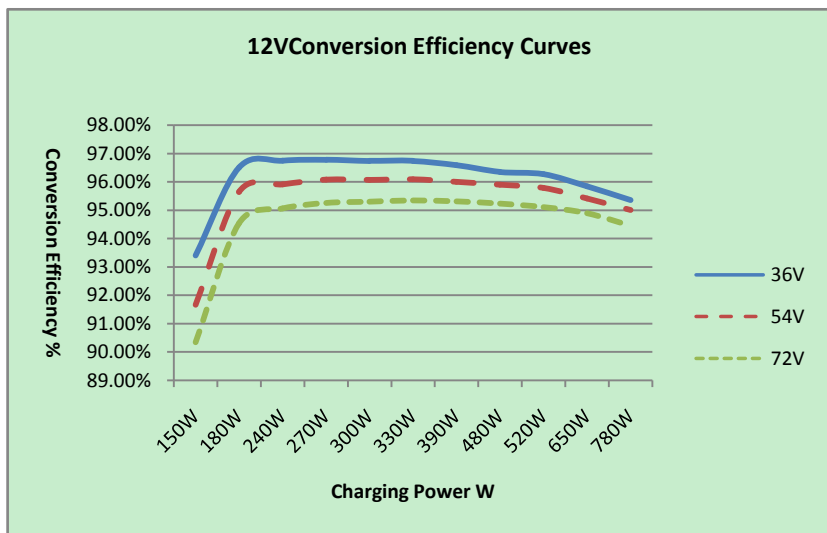

2. Solar MPPT Voltage(36V, 54V, 72V) / System Voltage(24V)

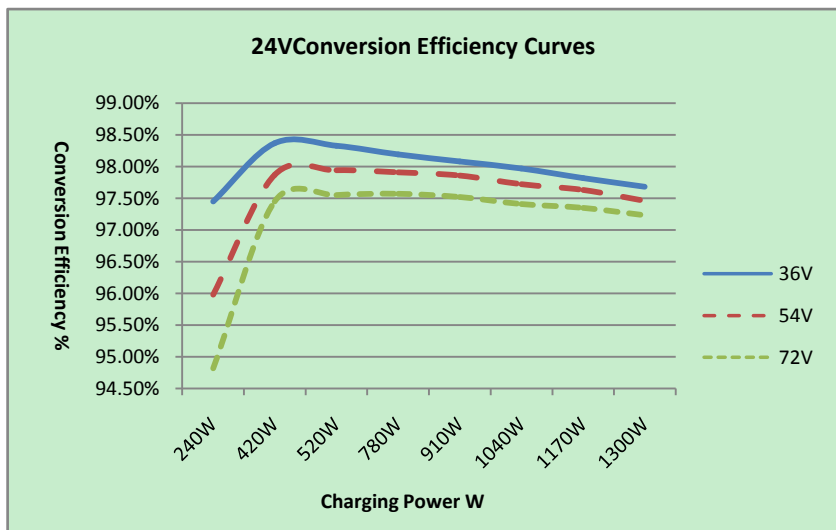

3. Solar MPPT Voltage(54V, 90V, 108V) / System Voltage(36V)

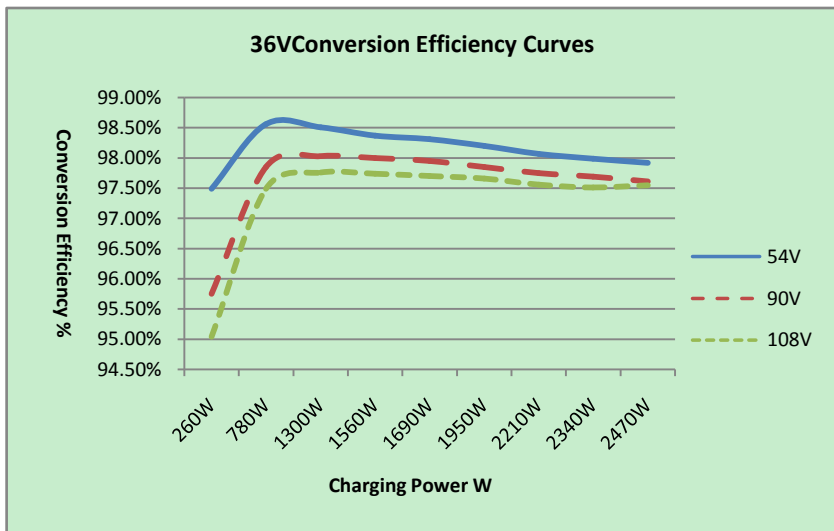

4. Solar MPPT Voltage(72V, 90V, 108V, 126V) / System Voltage(48V)

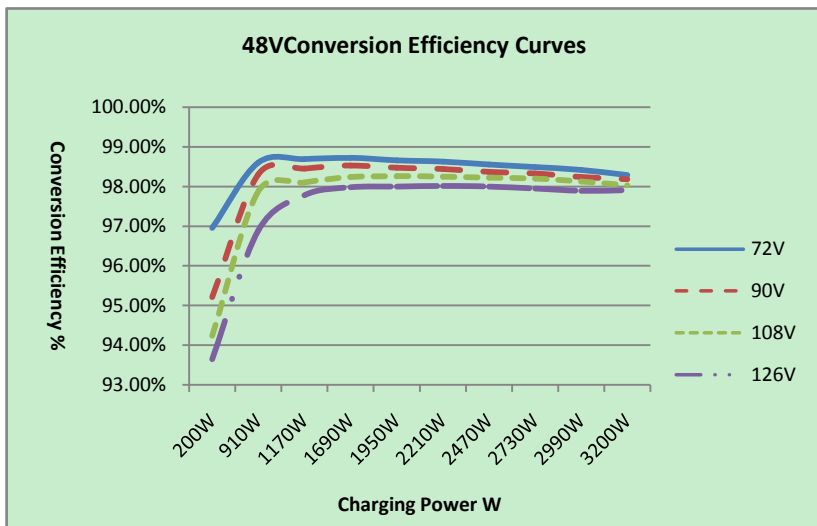

Annex II Dimensions

ET4415BND Dimensions (Unit: mm)

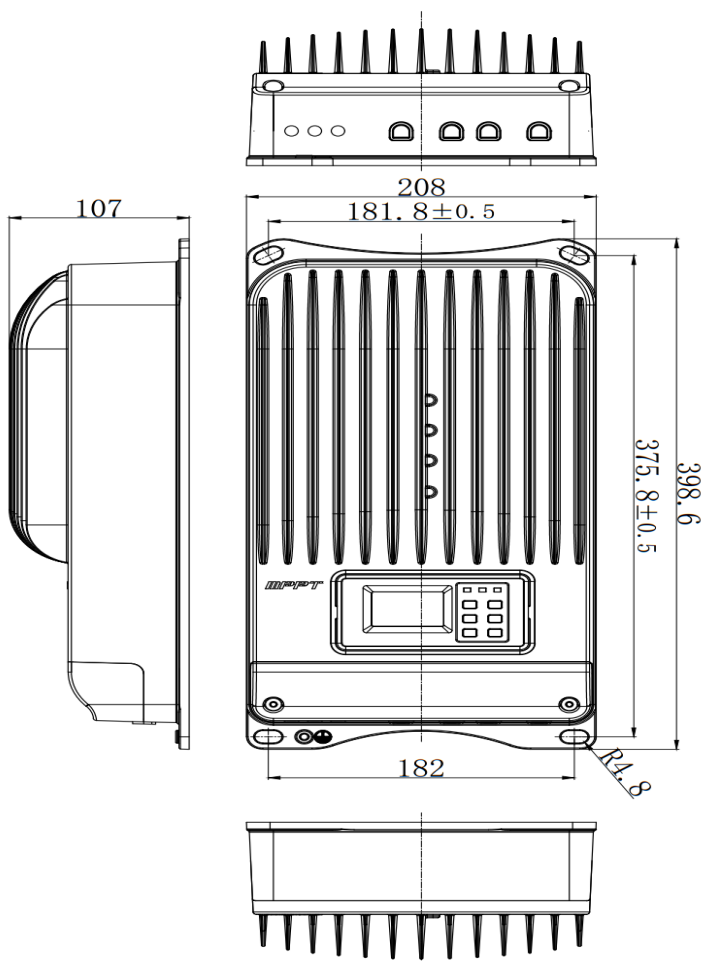

ET6415BND/ ET6420BND Dimensions (Unit: mm)

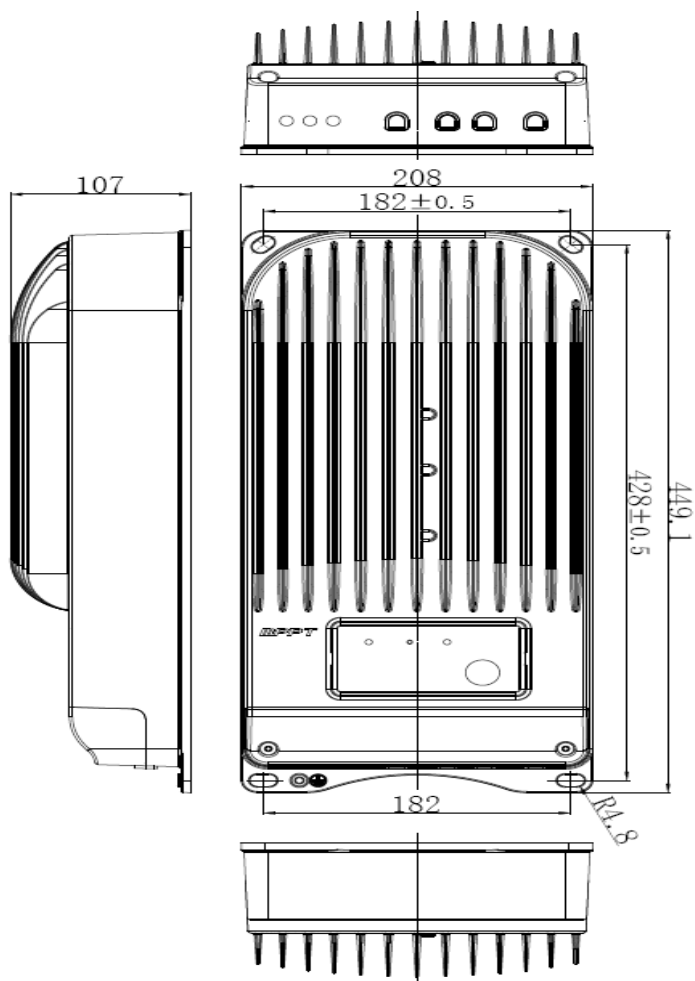

Final interpretation right of the manual belongs to EPsolar. Any changes without prior notice!

Version number: V1.4



BEIJING EPSOLAR TECHNOLOGY CO., LTD.

Tel: +86-10-82894112 / 82894962

Fax: +86-10-82894882

E-mail: info@epsolarpv.com

Website: <http://www.epsolarpv.com/>

<http://www.epever.com/>