

BAJARACK WARRANTY



This Limited Warranty covers BajaRack products and all accessories for a period of 2 years from the date of purchase to the original owner of the product and does not apply once the equipment is sold or transferred to another person.

This Warranty does not cover the cost of removal of reinstallation or the product. BajaRack warrants (subject to conditions listed in this warranty) all products to be free of manufacturing defects in materials and workmanship.

Warranty claim requirements

The claim has to be submitted during the warranty period at the place of purchase or directly at our corporate office located:



BajaRack Adventure Equipment
2275 Michael Faraday Drive, Suite 6
San Diego, CA 92154 USA
Phone Number: 760-621-0171

On your product you will find a label with a serial number. If you remove this label, please save the serial number in a safe place. You will need it if you want to make a warranty claim in the future. Any cost incurred to transport the defective product "to and from" will be the customer's responsibility.



Warranty resolution

Subject to BajaRack inspection of the product, the company will remedy defects in materials and/or workmanship by repairing or replacing, at BajaRack's option, the defective product without charge for parts or labor, subject to the limitations and exclusions described in this warranty. BajaRack may elect, at its option, not to repair or replace a defective product, in which case BajaRack will issue to the original retail purchaser, at BajaRack's option, either a full refund equal to the purchase price paid for the product, or a credit to be used toward the purchase of new BajaRack products or accessories.

Limitations of Liability

BajaRack is not liable for damage caused by shipping or transport of BajaRack products. It is the responsibility of the original retail purchaser to inspect all products prior to acceptance and to notify the shipping carrier in a timely manner so that any claim for damages can be made. If timely notification to the shipping carrier by the original retail purchaser is not made regarding damage caused during the transport of the product, a claim for damages may not be possible, and all liability falls to the original retail purchaser. This warranty does not apply if accident, abuse, misuse, collision, overloading, modification, misapplication, improper installation, or improper service has damaged the Product.

BAJARACK SHALL NOT BE LIABLE FOR ANY DIRECT, INDIRECT, CONSEQUENTIAL, INCIDENTAL, SPECIAL, EXEMPLARY, OR PUNITIVE DAMAGES OR FOR ANY OTHER DAMAGES OF ANY KIND OR NATURE [NO PERIOD.] (INCLUDING, BUT NOT LIMITED TO, LOST PROFITS, DOWN TIME OR LOSS OF USE) UNDER ANY LEGAL THEORY, EVEN IF BAJARACK WAS ADVISED OF THE POSSIBILITY OF SUCH DAMAGES. BAJARACK'S SOLE LIABILITY IS LIMITED TO THE REMEDY SET FORTH ABOVE.

BajaRack reserves the right to change Product design without notice.



YAKIMA & THULE

ACCESSORY MOUNT (2PCS)



Yakima & Thule Accessory Mount

RACK COMPONENTS

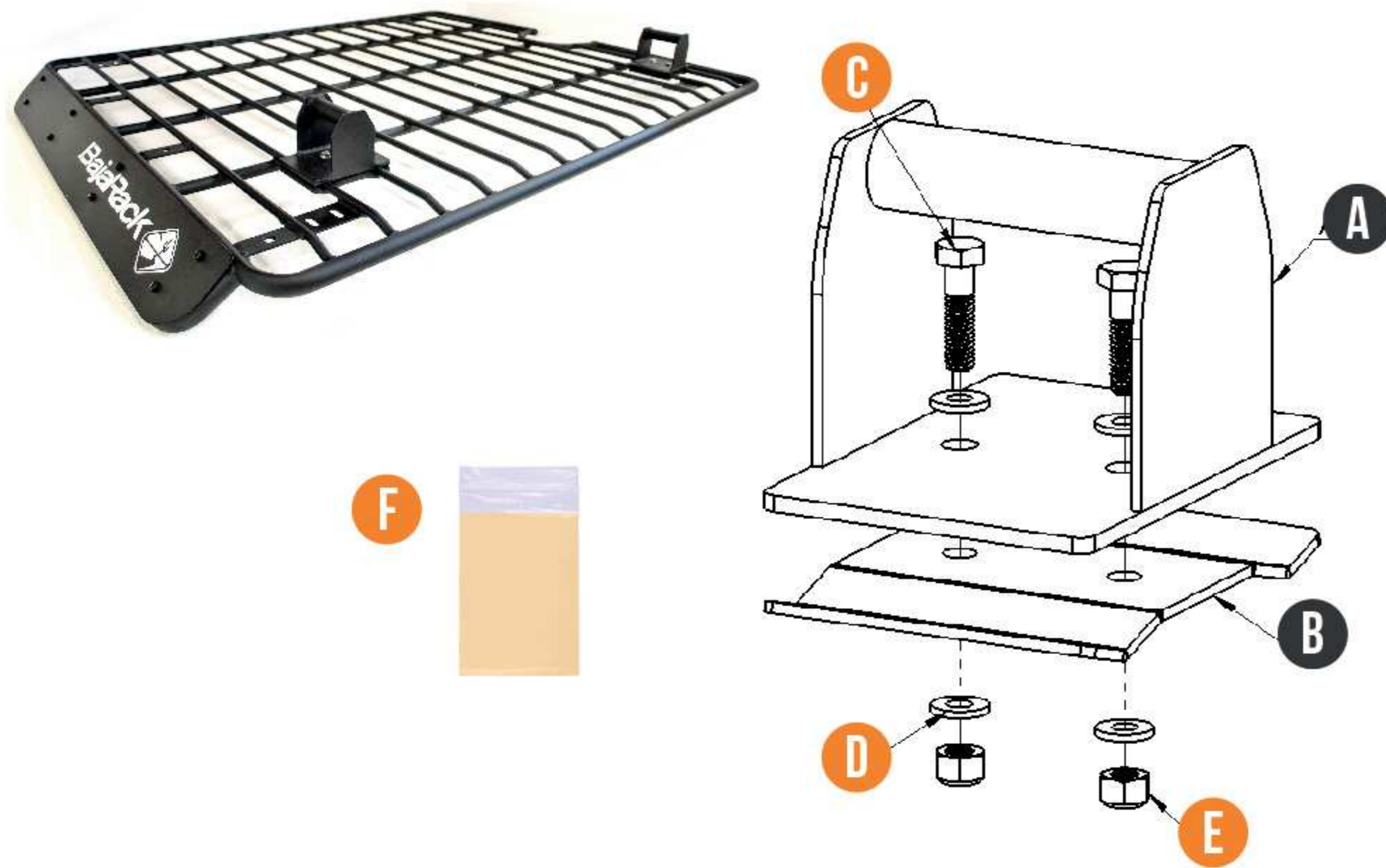

- A) Base plate (2x)
- B) Holding Plate (2x)

What's in the box

- C) 5/16" x 1 1/2" Hex Cap Screw Zinc Finish (4x)
- D) 5/16" Flat Washer Zinc Finish (8x)
- E) 5/16" Nylon Insert Lock Nut Zinc Finish (4x)
- F) Grease, for use with all bolts with lock nuts (1x)

Recommended Tools

- 1/2" wrench for installation
- 1/2" ratchet tool for support

Tips and recommendations (please read)

- Add grease is very important to avoid damage on the hardware threads

INSTALLATION STEPS

- 1 Place the Base plate (A) on top of the rack's roof as shown in picture above. The Location will depend on the kind of your accessory.



- 2 Place the Holding plate (B) below the Base plate (A). Insert washers (D) and bolts (C) in the base plate holes, then, inserting washers (D) and nylon lock nuts (E) in the bolts (C).

Note: Tighten bolts with the hand. Do not forget to add some grease (F) on the bolt's thread before inserting bolts in nylon lock nuts.



- 3 Repeat step 1 and 2 for other mount and adjust the mounts according to your accessory.



INSTALLATION STEPS

- 4 Tighten the bolts with a 1/2" wrench and 1/2" ratchet tool, and now you can install your Yakima or Thule accessory!



ENJOY
— YOUR NEW —
YAKIMA & THULE
ACCESSORY!



TECHNICAL SPECIFICATIONS

YAKIMA & THULE ACCESSORY

BR-YTFAM-2-0

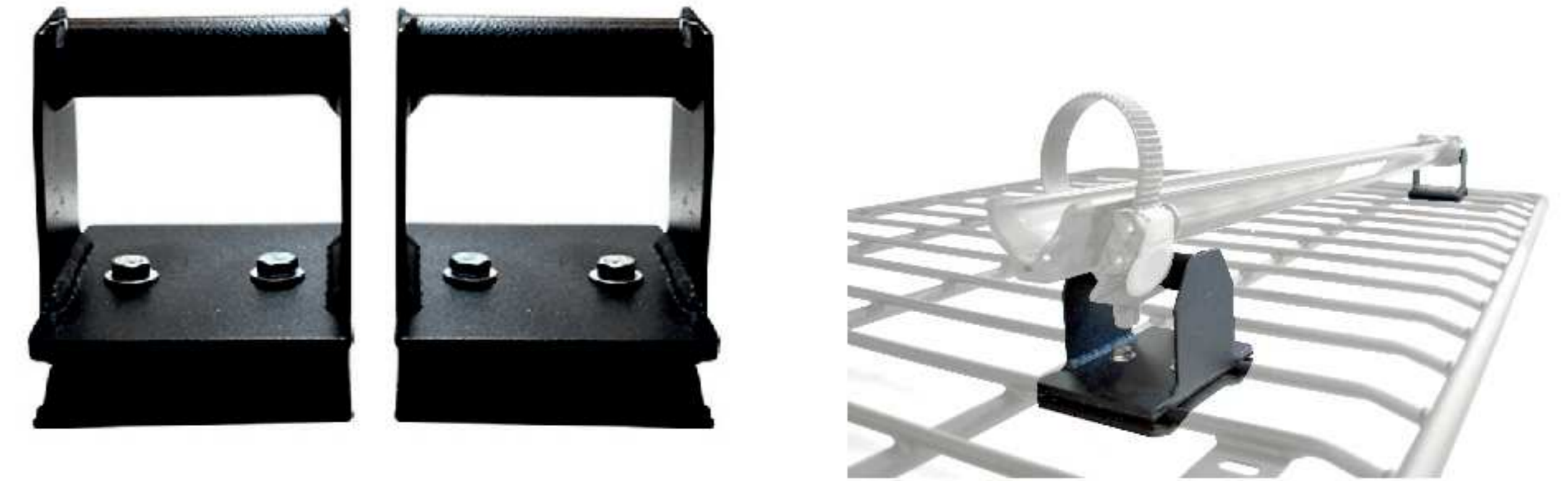

Material and Thickness: 1 Inch (25.4 mm) carbon steel tube and 1/8 Inch (3.175 mm) steel.

Finish: Epoxy primer (rust barrier) with black powder coating

Mounting Method: These mounts install on the floor of the rack.