



# RIVERQUIVER

## TRUCK BED MOUNT SHORTCUT

---

FLY ROD HOLDER. LOCKED. LOADED. READY TO FISH.

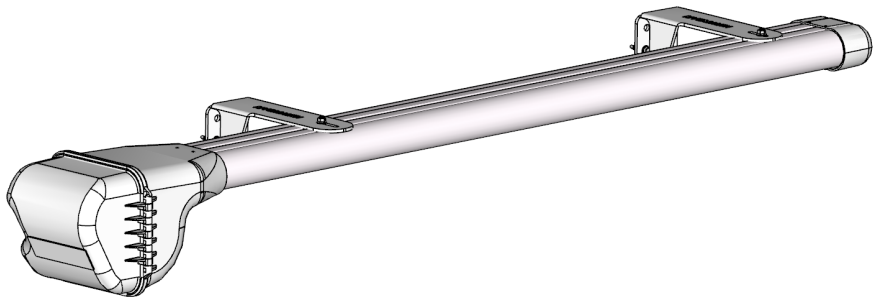

## INSTALLATION GUIDE

---

[WWW.RIVERSMITH.COM](http://WWW.RIVERSMITH.COM)

@RIVERSMITHUSA



Patent Pending

# CONTENTS

---

- 1 INCLUDED PARTS
- 2 TOOLS NEEDED & MOUNT ASSEMBLIES
- 3 STEP 1 - PREPARE VEHICLE
- 4-5 STEP 2 - INSTALL BED MOUNTS
- 6 STEP 3 - INSTALL SHORTCUT RIVER QUIVER
- 7 SAFETY INFORMATION
- 8 DRIVING
- 9 MAINTENANCE

# STOP!

IF YOU HAVE A DROP-IN BED LINER.



If installing Bed Mounts with self-tapping screws through a bed liner, the bed liner **MUST BE FLUSH** to the bed panel. Gaps will prevent proper installation. Flush fit and spray-in bed liners are acceptable for installation.

See FAQs at [riversmith.com](http://riversmith.com) for troubleshooting

# INCLUDED PARTS

## 2-BANGER

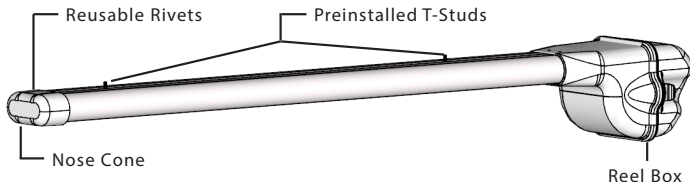

PARTS

### BED PANEL ATTACHMENT

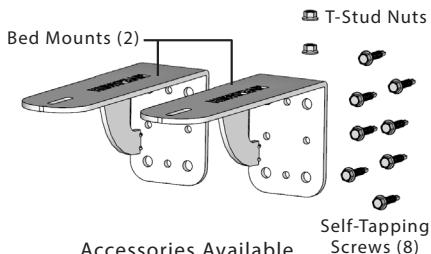

#### Accessories Available

- Cargo Rail Security Fasteners
- Rod Chairs
- Reel Box Pads

See full lineup of Accessories at [www.riversmith.com](http://www.riversmith.com)

(OR)

### CARGO RAIL ATTACHMENT

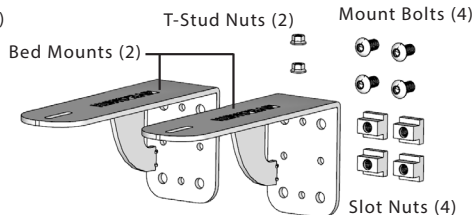

The ShortCut RQ is built and tested to the highest possible standards to securely transport and protect your gear, however it is not meant as a long term storage solution.

## TOOLS NEEDED FOR PANEL ATTACHMENT



Pencil/Sharpie



Measuring  
Tape



Drill w/  
3/8 Hex Bit



10mm  
Nut Driver



3/8  
Nut Driver

## TOOLS NEEDED FOR CARGO RAIL ATTACHMENT



Pencil/Sharpie



Measuring  
Tape



10mm  
Nut Driver



1/4  
Hex Wrench

## BED MOUNT ASSEMBLIES

PANEL ATTACHMENT

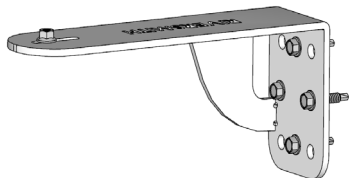

CARGO RAIL ATTACHMENT

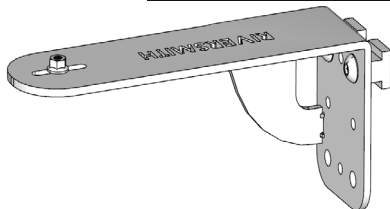

## STEP 1 PREPARE VEHICLE

**NOTE:** Standard ShortCuts are 5'-8" in total length. If you have a 5' bed (shortbed), the 5' ShortCut is required for bed attachment.

Prepare Vehicle - DO NOT INSTALL BED MOUNTS THROUGH DROP-IN BED LINERS.

1

Measure the desired height of the River Quiver and mark it on the bed of the truck. Locate the first bed mount between 13in - 18in from the inside of the tail gate (when closed).

- Mark same height for second bed mount within 36-40in from the center of the first mount.
- If Reel Box touches the tail gate, you will need to shift your mounts forward accordingly.

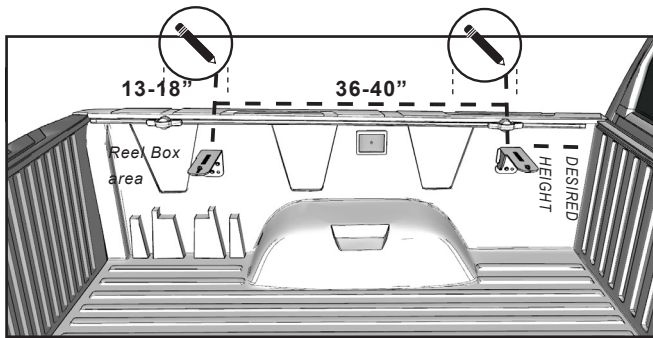

## STEP 2

### Installing the Direct Panel Attachment Bed Mounts

2

For direct panel attachment, locate the center of the bed mount with the mark made in Step 1 and install a self tapping screw in the top center hole using a drill and 3/8 hex bit. Fully tighten with a hand driver. **DO NOT OVER TORQUE** the self-tapping screws. Ensure the mount is level and repeat this step for the remaining 3 screws. Repeat this entire process for the remaining 3 screws. Repeat this entire process for the second bed mount.



- DO NOT OVERTIGHTEN OR DAMAGE WILL OCCUR

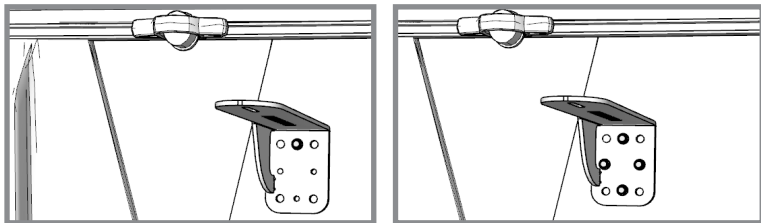

## STEP 2A

### Installing the Cargo Rail Attachment Bed Mounts

2A

For cargo rail attachments, start by assembling the mount bolts in the top left and right holes. Loosely thread the slot nuts onto each mount bolt on the backside of the bed mount. Slide the mount onto the cargo rail t-track ensuring both slot nuts properly engage with the track. Leave loose until the final step.

Repeat this entire process for the next bed mount.

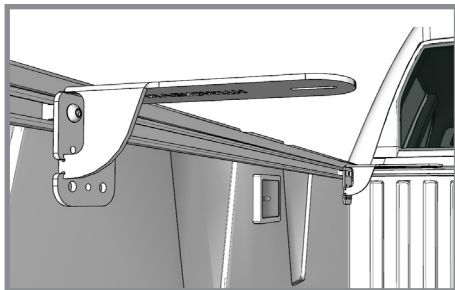
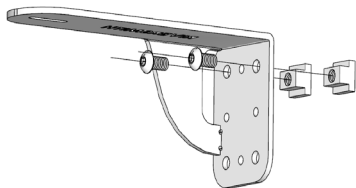

STEP 2A



## STEP 3

### Install ShortCut River Quiver

**3B**

Align the pre-installed t-studs with the slots on the bed mount. Then install the t-stud nut onto each t-stud loosely securing the ShortCut in position.

- Check to make sure the Reel Box lid can open when tail gate is down, and the tail gate does not hit the Reel Box Lid when closed.
- When confirmed, fully tighten all nuts and bolts

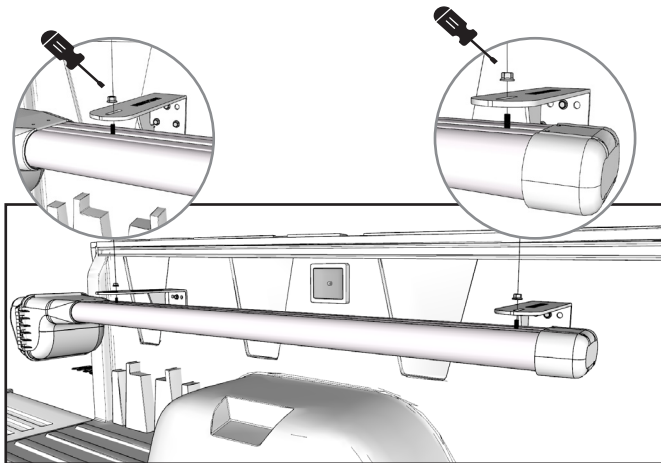

# SAFETY INFORMATION

---

- Improperly secured loads and incorrectly installed bed mounts can come loose causing damage to property, serious injury, or death.
- Always place bed mounts as far apart as possible before mounting ShortCut RQ.
- Check all rack and mount hardware:
  - Before any trips
  - After a short drive following initial install
  - At regular intervals during use
  - Anytime rough terrain is encountered
- Do not stack objects onto or attach accessories to the ShortCut when attached to the Bed Mounts. They are not rated for loading beyond the weight of the ShortCut.
- Do not attach accessories to ShortCut RQ when attached to bed mounts.

# DRIVING

- Do not exceed posted speed limits or speeds appropriate for the terrain and conditions.
- Off road driving is not recommended and could result in damage to vehicles, accessories, or gear.
- Adjust speed for curves.

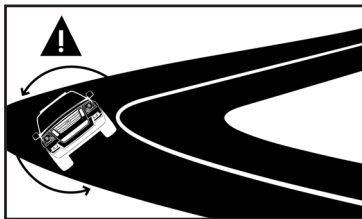

## MAINTENANCE AND USE

- **ShortCut RQ must be locked in order to function properly.**
- ShortCut RQ should be cleaned regularly with mild soap and water for maximum longevity.
- Always travel with in rod taken down to two sections secured with Rod Chairs in the ShortCut RQ.
- Periodically inspect ShortCut RQ and Bed Mounts for damage. Replace lost, damaged, or worn parts with original replacement parts from Riversmith.
- Any modifications made to the Bed Mounts or ShortCut RQ or repairs made with parts other than those supplied by the manufacturer will void warranty and liability.
- To replace lost or damaged keys, record key/lock number and register product online at [www.riversmith.com](http://www.riversmith.com)
- In the case you want to mount from the underside t-track, the rivets holding the nose cone are removeable/reusable. Simply insert a flathead screwdriver under the nose cone within the T-Track and pry firmly upward/downward to release the press in rivet. To reattach press the rivets back into their corresponding holes.

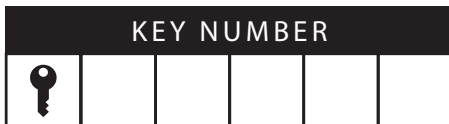

Note: View Warranty, Register Product, and Watch Installation Tutorial at: [www.riversmith.com](http://www.riversmith.com)

— SHORTCUT RQ IS A PRODUCT BY —

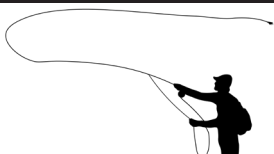

## RIVER QUIVER LOCKED & LOADED LIMITED LIFETIME WARRANTY

Riversmith takes pride in the products we manufacture and will warrant that all River Quiver Rooftop Fly Rod Holders will be free from defects in workmanship and materials for the life of the product to the original purchaser ("you"), subject to the below conditions:

- ShortCut RQ was purchased from a Riversmith authorized dealer;
- You can provide proof of purchase from the Riversmith authorized dealer;
- The product was used only as intended and in accordance with the ShortCut RQ installation guide.

If a defect occurs during intended use (according to the installation guide), we will replace, at our discretion, the defective product or part. The warranty does not cover defects caused by misuse, overloading, modifications, or improper assembly. Cosmetic damage, loss, theft, normal wear and tear, and the natural breakdown of colors and materials over time and use are not warranted. If damage is deemed outside of the scope of this warranty, replacement parts will be available at discounted prices.

### Warranty Disclaimer:

UNDER NO CIRCUMSTANCES, WHETHER FOR BREACH OF WARRANTY, BREACH OF CONTRACT, NEGLIGENCE, OR OTHER TORT, OR ANY STRICT LIABILITY THEORY, WILL RIVERSMITH BE LIABLE FOR ANY INCIDENTAL OR CONSEQUENTIAL DAMAGES TO NON-RIVER QUIVER PRODUCTS USED IN CONJUNCTION WITH RIVER QUIVER PRODUCTS.

The warranty is only available in the United States. No Riversmith reseller, agent, or employee is authorized to make any modification, extension, or addition to this warranty.