

**STAR
WARS**™

**SNOWTROOPER
HELMET KIT**

**ASSEMBLY
INSTRUCTIONS**



 ANOVOS®

TOOLS NEEDED

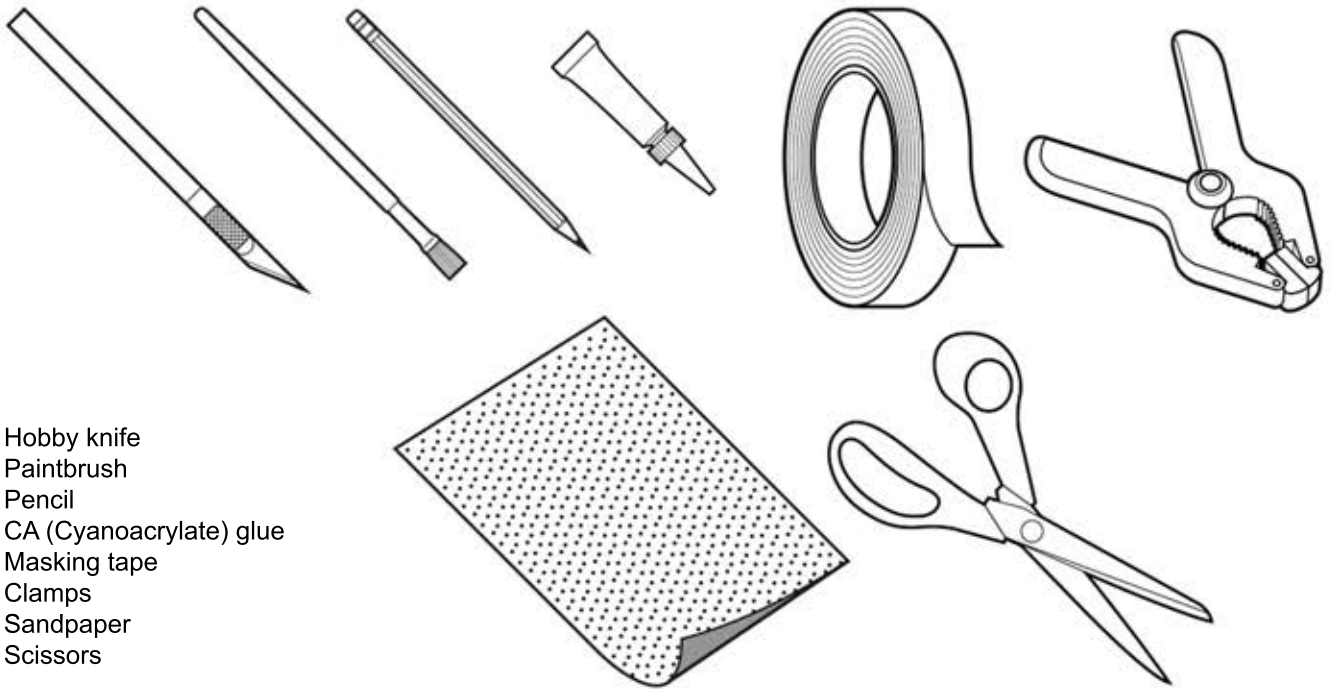

- Hobby knife
- Paintbrush
- Pencil
- CA (Cyanoacrylate) glue
- Masking tape
- Clamps
- Sandpaper
- Scissors

SAFETY



- Use caution when handling sharp instruments and tools.
- Wear safety glasses, dust mask and work gloves during assembly to prevent injury.
- Stay in well ventilated area when using any glue or paint.
- Keep small children away from poly-bags and all tools.

HELMET PIECES

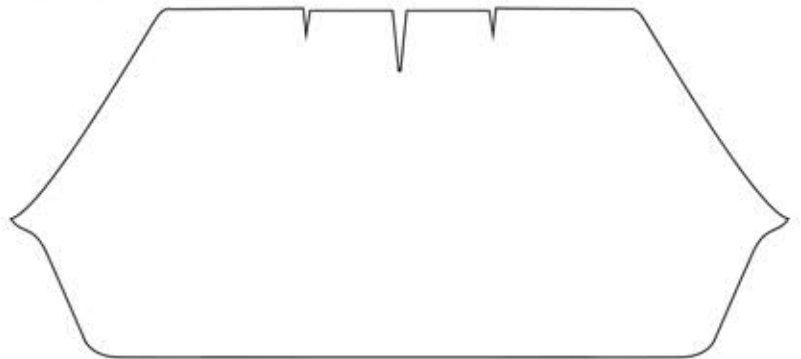
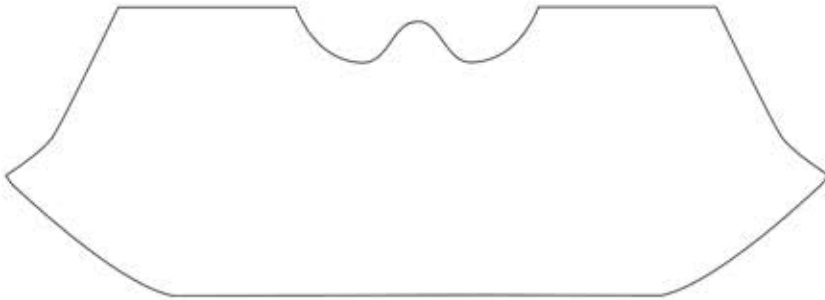
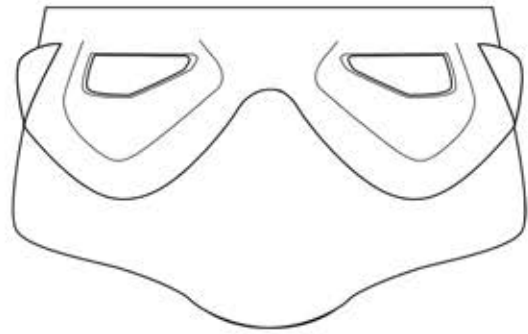
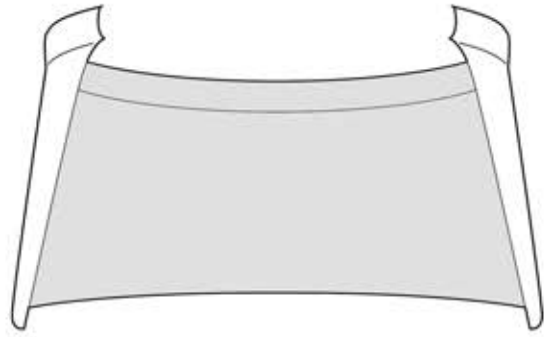
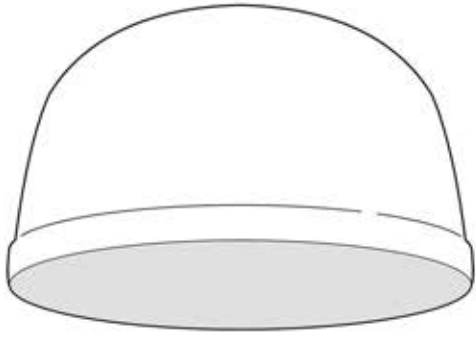

HOOK & LOOP



SEAM TAPE

COMMON TECHNIQUES



GLUING *(sand surfaces to be glued)*

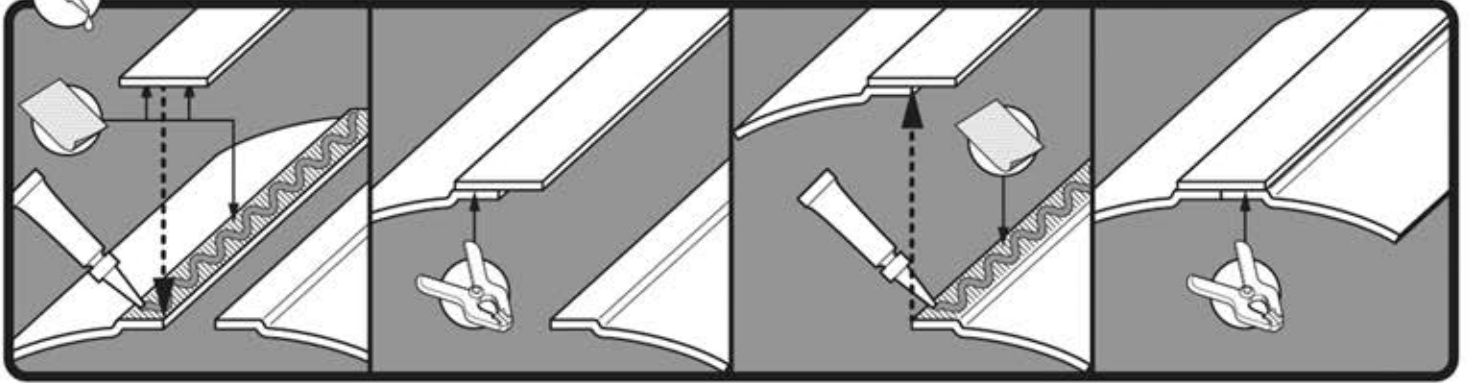

ASSEMBLY

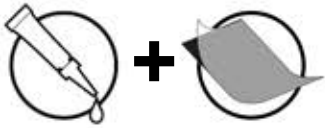

REMOVE BACKING AND FASTEN ADHESIVE SIDE DOWN



2

2

GLUE VISOR TO INSIDE OF EYE PIECE



1

1

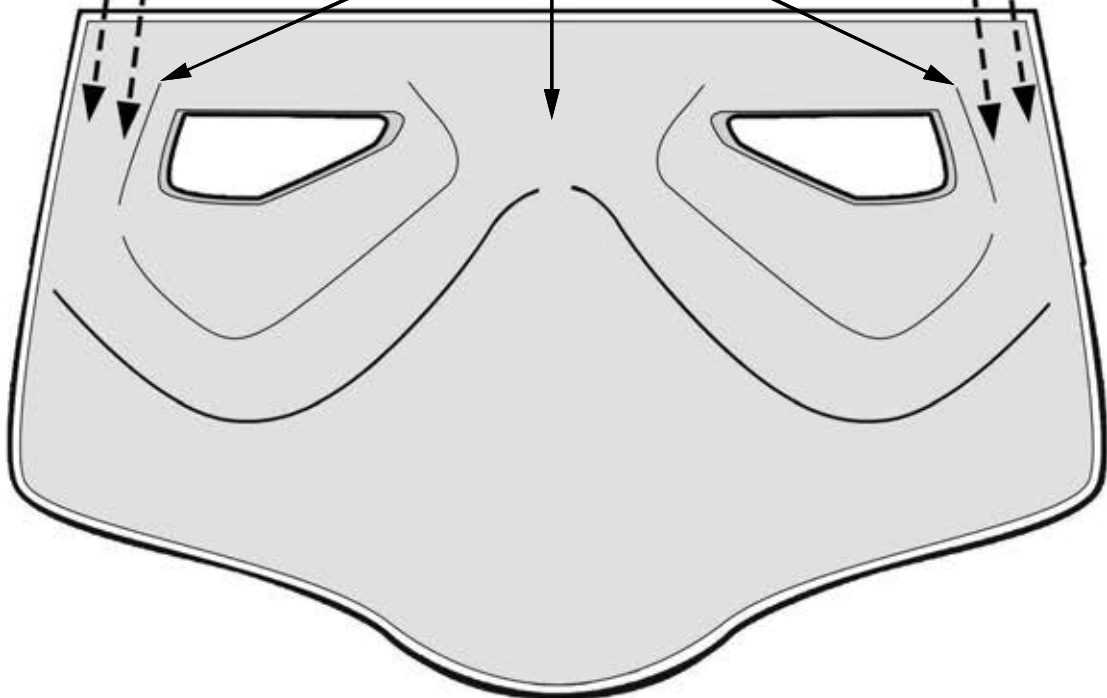

ASSEMBLY

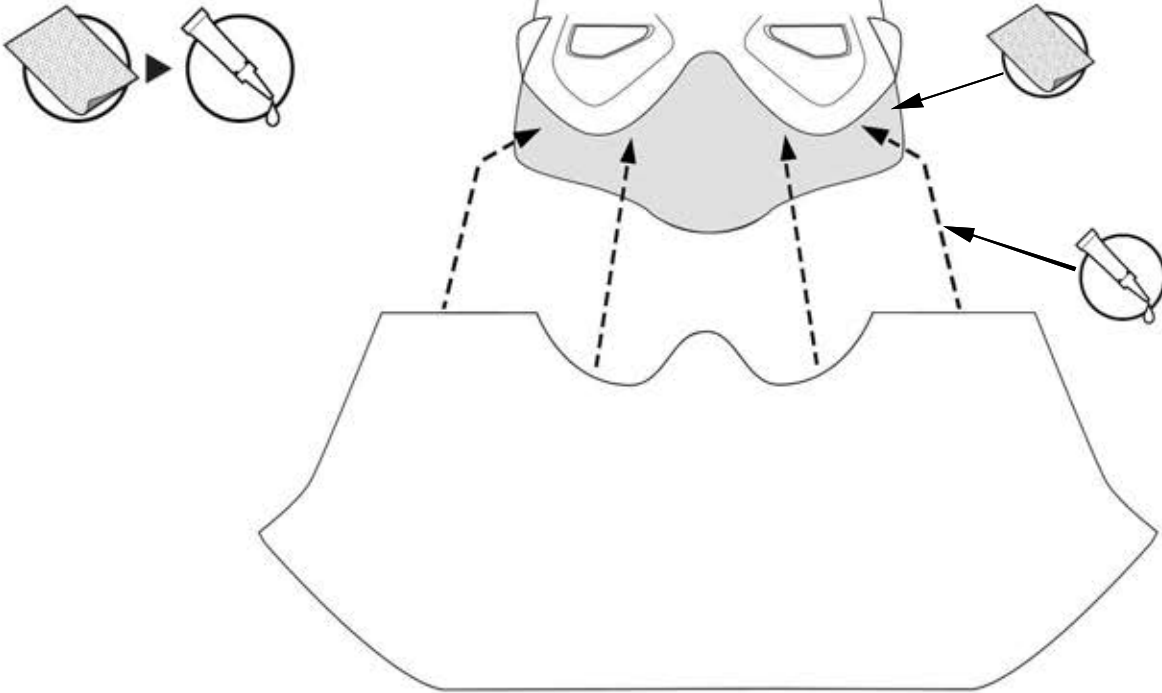

ASSEMBLY

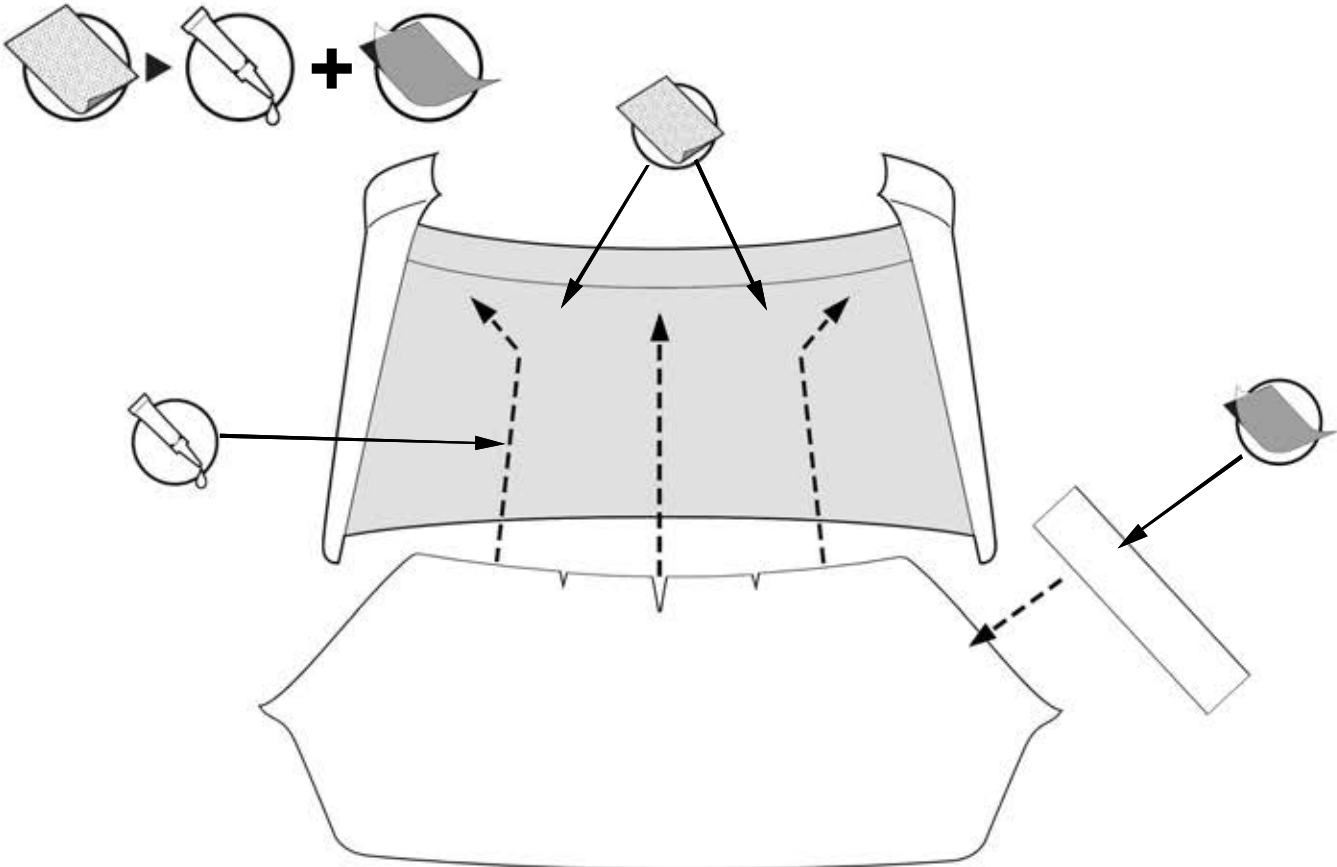

ONCE BACK SHEET HAS BEEN AFFIXED IN DESIRED POSITION,
USE PROVIDED SEAM TAPE TO COVER INTERIOR SEAM LINES

HOOK and LOOP *(be sure to clean the surface before applying adhesive Hook and Loop)*

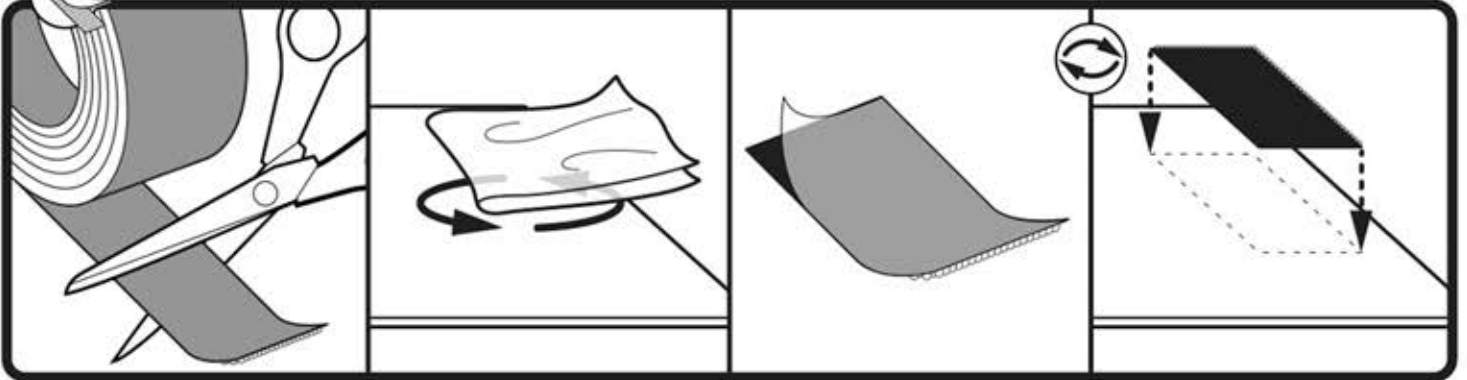

ASSEMBLY

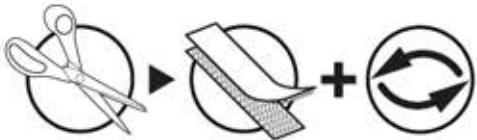

CUT HOOK & LOOP STRIP INTO FIVE EQUAL LENGTH PIECES.

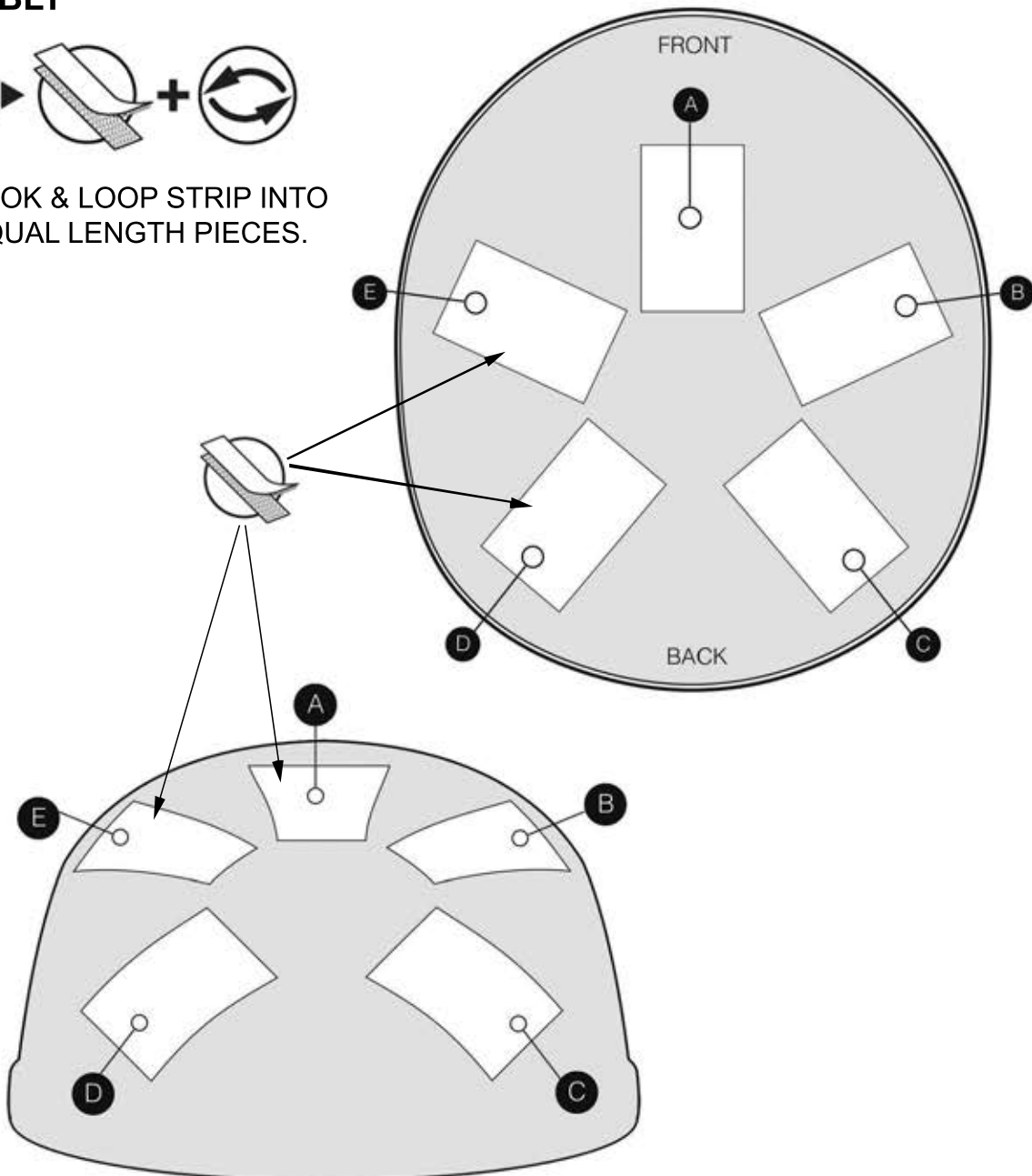

ASSEMBLY

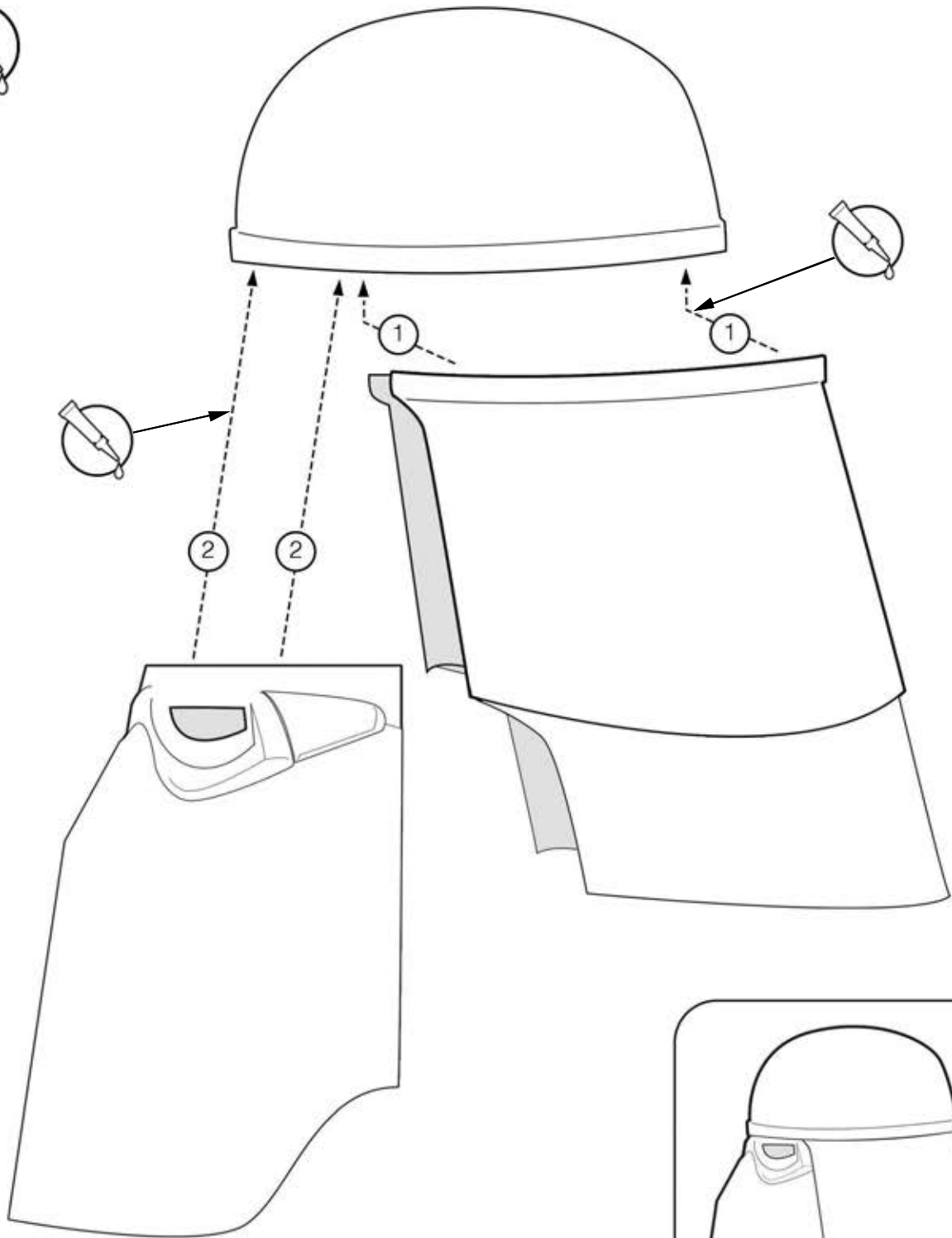

Downloadable assembly instruction booklet available at:
www.ANOVOS.com/pages/star-wars-product-instructions

www.STARWARS.com

© & ™ Lucasfilm Ltd.

Product subject to change without notice. Actual product may vary.

ANOVOS Logo ©, © 2017 ANOVOS, All Rights Reserved.

ANOVOS, 1197 East Los Angeles Ave, Suite C301, Simi Valley, CA 93065 USA

www.ANOVOS.com/StarWars

THIS IS NOT A TOY. NOT INTENDED FOR CHILDREN.

(Version 2017, VI)

