



HURDER MILLWORK

www.HurderMillwork.com

**STOCK AND CUSTOM
MOULDING OPTIONS**



HURDER MILLWORK

Basecap Profiles	100
Raised Panel Profiles.....	200
Misc. Panel Profiles	200
Wainscot Profiles	300
Backband Profiles	420
Chair Rail Profiles	500
Astragal Profiles.....	560
Crown Profiles	600
Baseboard Profiles.....	700
Casing Profiles	800
Hand Rail Profiles	6010
Index of Profiles by Number.....	1





HURDER MILLWORK

www.HurderMillwork.com

**BASECAP
PROFILES**



HURDER MILLWORK

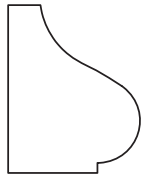

IN-STOCK

HM100

1 1/16" x 7/8"



IN-STOCK

HM101

1/2" x 1"

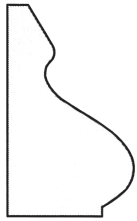

IN-STOCK

HM102

5/8" x 1 1/8"

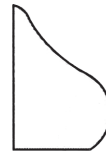

IN-STOCK

HM103

1/2" x 3/4"

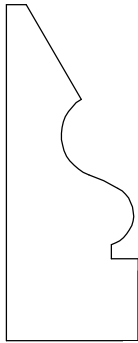

IN-STOCK

HM104

1 1/16" x 1 3/4"



HM105

5/8" x 1 1/8"

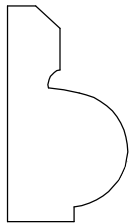

HM106

5/8" x 1 1/8"

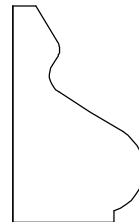

HM107

1 1/16" x 1 1/8"



HM108

1/2" x 1 3/8"



HM109

1/2" x 1 3/8"

HURDER MILLWORK

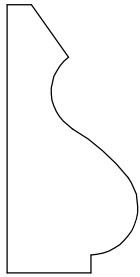

HM110
11/16" x 1 3/8"

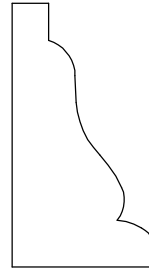

HM111
3/4" x 1 3/8"

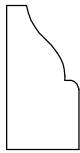

HM112
3/8" x 3/4"

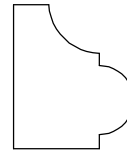

HM113
5/8" x 3/4"

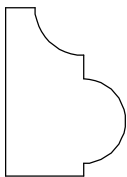

HM114
3/8" x 7/8"

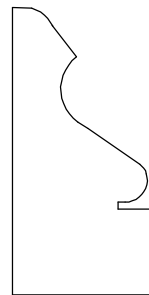

HM115
3/4" x 1 1/2"

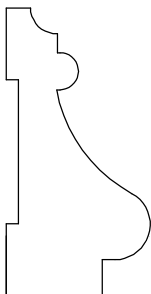

HM116
3/4" x 1 1/2"

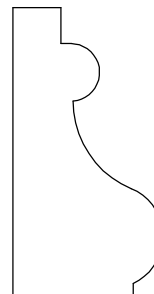

HM117
25/32" x 1 1/2"

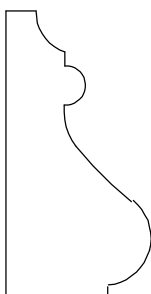

HM118
3/4" x 1 1/2"

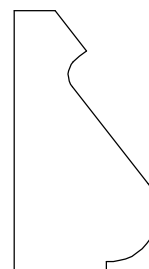

HM119
3/4" x 1 3/8"

HURDER MILLWORK

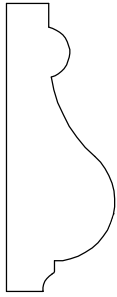

HM120
9/16" x 1 1/2"



HM121
7/16" x 3/4"



HM122
1 1/16" x 1 5/8"



HM123
5/8" x 1 1/2"



HM124
1/2" x 3/4"



HM125
1/2" x 3/4"



HM126
1/2" x 3/4"



HM127
9/16" x 1"

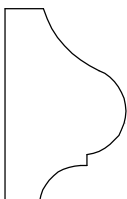

HM128
5/8" x 1"

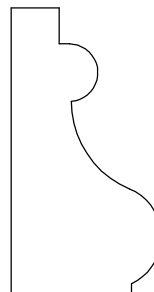

HM129
1 1/16" x 3/4"

HURDER MILLWORK

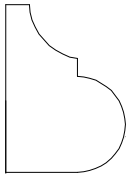

HM130
5/8" x 7/8"

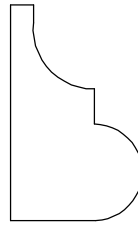

HM131
5/8" x 7/8"

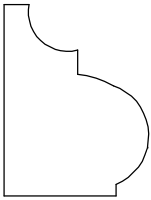

HM132
3/4" x 1"

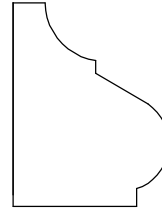

HM133
13/16" x 1 1/16"

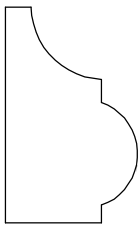

HM134
11/16" x 1 1/8"

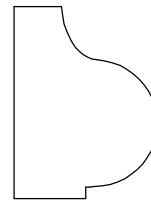

HM135
3/4" x 1"

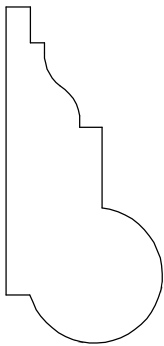

HM136
13/16" x 1 3/4"

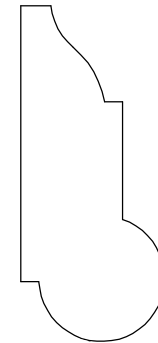

HM137
3/4" x 1 3/4"

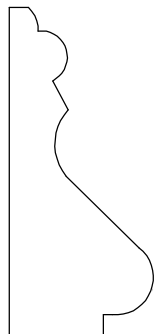

HM138
3/4" x 1 23/32"

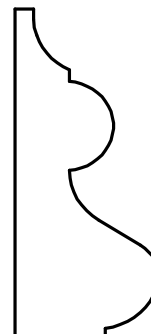

HM139
3/4" x 1 23/32"

HURDER MILLWORK

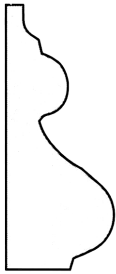

HM140
9/16" x 1 3/8"



HM141
11/16" x 2"

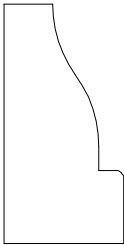

HM142
5/8" x 1 1/4"

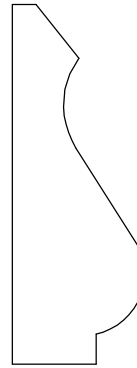

HM143
11/16" x 1 7/8"

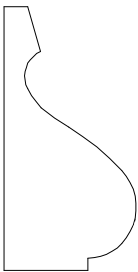

HM144
11/16" x 1 3/8"



HM145
1/2" x 1 3/4"

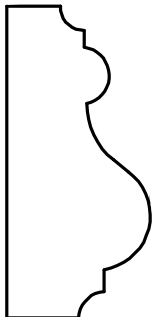

HM146
3/4" x 1 5/8"



HM147
9/16" x 1 9/16"

HURDER MILLWORK

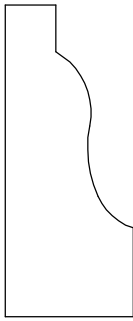

HM148
11/16" x 1 5/8"



HM149
5/8" x 1 3/16"

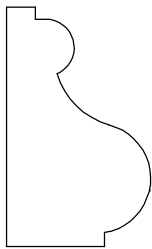

HM150
3/4" x 1 1/4"

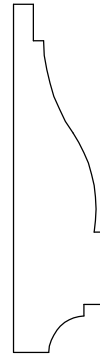

HM151
15/32" x 1 13/16"

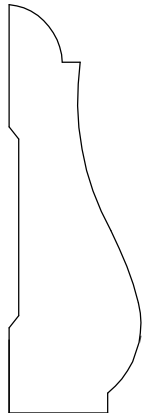

HM152
11/16" x 2 1/8"

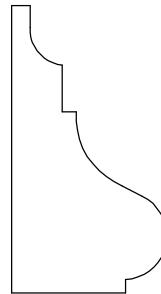

HM153
13/16" x 1 1/2"

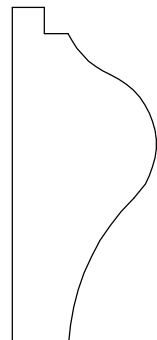

HM154
3/4" x 1 3/4"

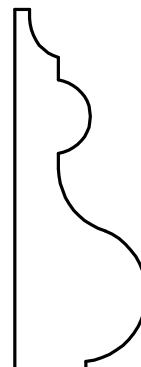

HM155
11/16" x 1 7/8"

HURDER MILLWORK

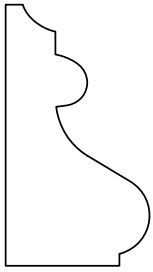

HM156
3/4" x 1 3/8"

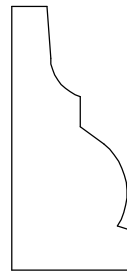

HM157
5/8" x 1 3/8"

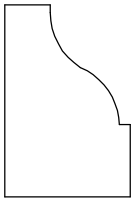

HM158
21/32" x 1"

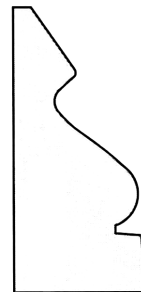

HM159
11/16" x 1 1/2"

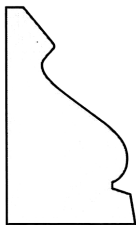

HM160
11/16" x 1 1/8"

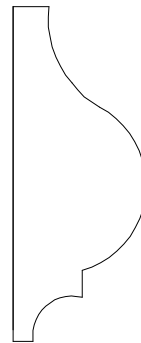

HM161
11/16" x 1 3/4"



HM162
5/8" x 1 7/16"

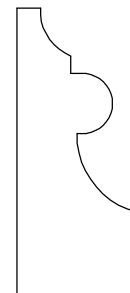

HM163
5/8" x 1 1/2"

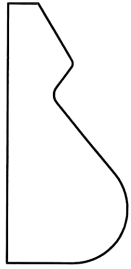

HM164
5/8" x 1 3/8"

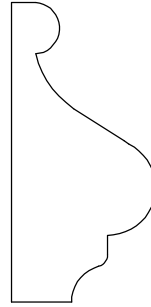

HM165
3/4" x 1 9/16"

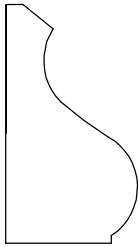

HM166
1 1/16" x 1 1/4"

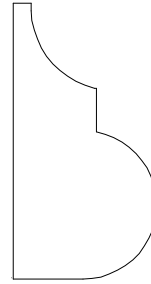

HM167
3/4" x 1 7/16"



HM168
1 1/16" x 1 3/4"

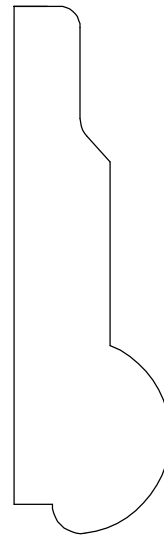

HM169
1 3/16" x 2 3/4"

HURDER MILLWORK

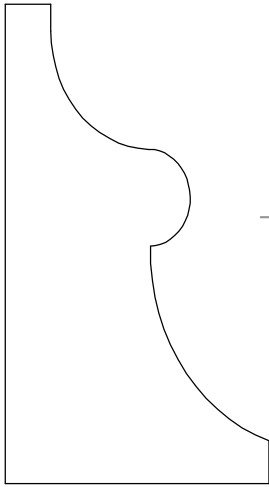

HM170
1 3/8" x 2 1/2"

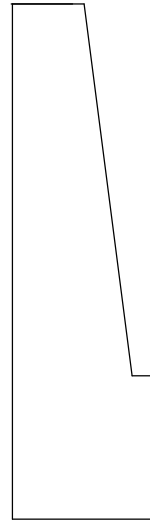

HM171
3/4" x 2 11/16"

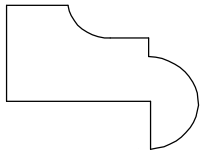

HM172
1" x 3/4"

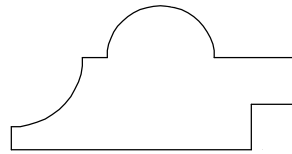

HM173
3/4" x 1 1/2"

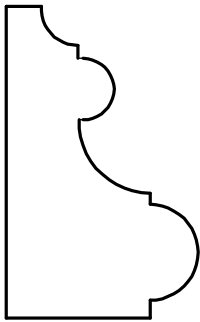

HM174
1" x 1 5/8"

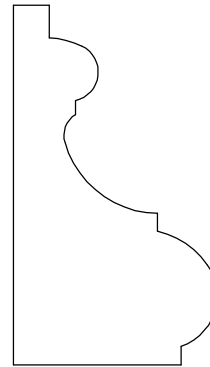

HM175
1 1/16" x 1 7/8"

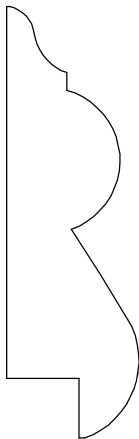

HM176
1 1/16" x 2 1/4"

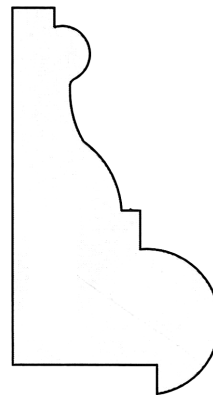

HM177
1 1/16" x 2"



HURDER MILLWORK

www.HurderMillwork.com

RAISED PANEL PROFILES



HURDER MILLWORK

IN-STOCK

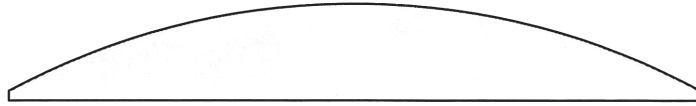

HM200

3 5/8" x 1/2"

IN-STOCK

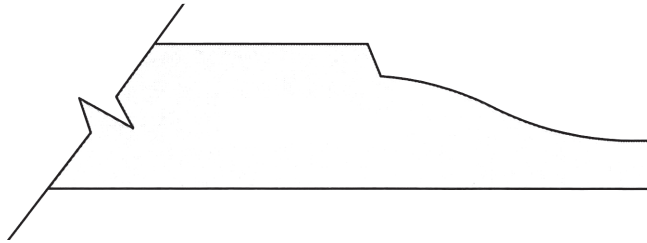

HM201

3/4" x 1 1/2"



HURDER MILLWORK

www.HurderMillwork.com

MISCELLANEOUS PROFILES



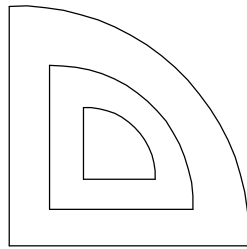

HM206

1 1/4" x 1 1/4"

**HURDER
MILLWORK**

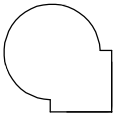

HM209

9/16" x 9/16"

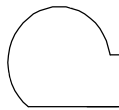

HM210

17/16" x 19/32"

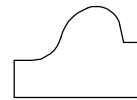

HM211

15/32" x 21/32"

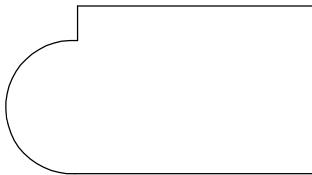

HM212

7/8" x 1 5/8"

HURDER MILLWORK



HM217
1/2" x 1/2"

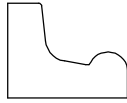

HM218
1/2" x 5/8"

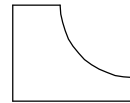

HM219
1/2" x 5/8"

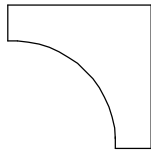

HM220
3/4" x 3/4"



HM221
3/4" x 3/4"

HURDER MILLWORK



HM225
3/8" x 3/8"

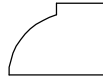

HM226
3/8" x 1/2"

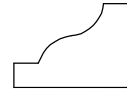

HM227
7/16" x 5/8"



HM228
7/16" x 5/8"

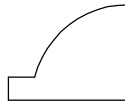

HM229
1/2" x 5/8"



HM230
7/16" x 3/4"

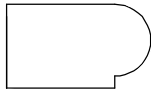

HM231
7/16" x 3/4"



HM232
1/2" x 3/4"

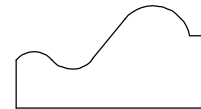

HM233
17/32" x 1"

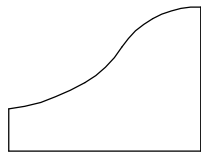

HM234
3/4" x 1"

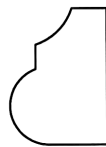

HM235
1/2" x 11/16"

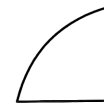

HM236
1/2" x 1/2"

HURDER MILLWORK



HM240

11/32" x 2 5/32"

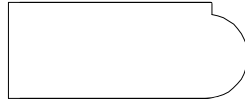

HM241

1/2" x 1 1/4"



HM242

7/16" x 1 3/8"



HM243

7/16" x 1 3/8"



HM244

7/16" x 1 3/8"

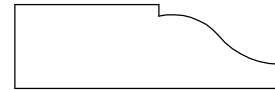

HM245

7/16" x 1 3/8"

NO ITEM
NO. 00111

HM246

1/2" x 1 3/8"



HM247

1/2" x 1 5/8"



HM248

3/8" x 2 5/16"



HM249

1/2" x 2 1/2"

**HURDER
MILLWORK**

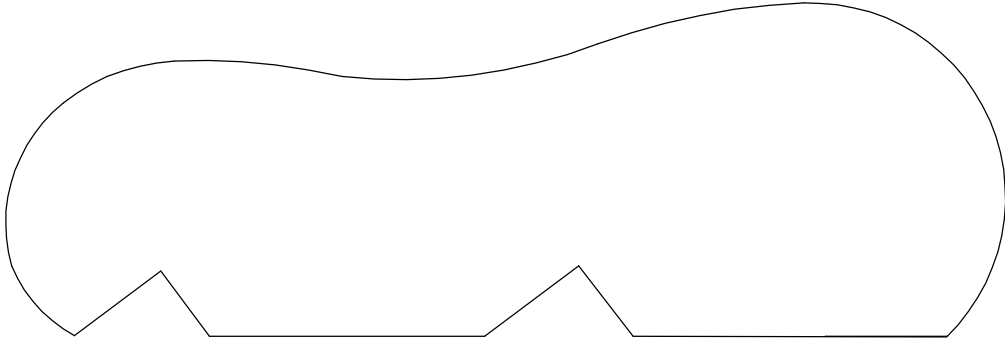

HM256

1 3/4" x 5 1/4"

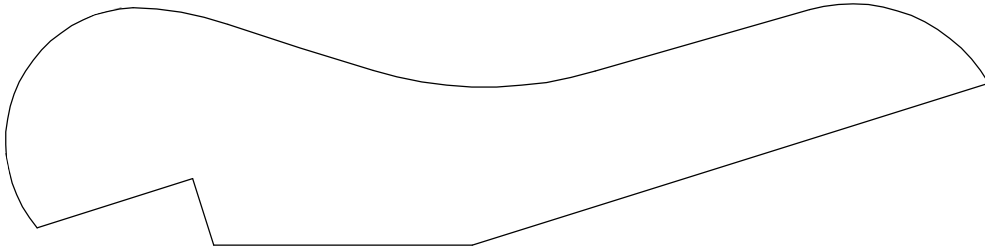

HM257

1 1/4" x 5 1/8"

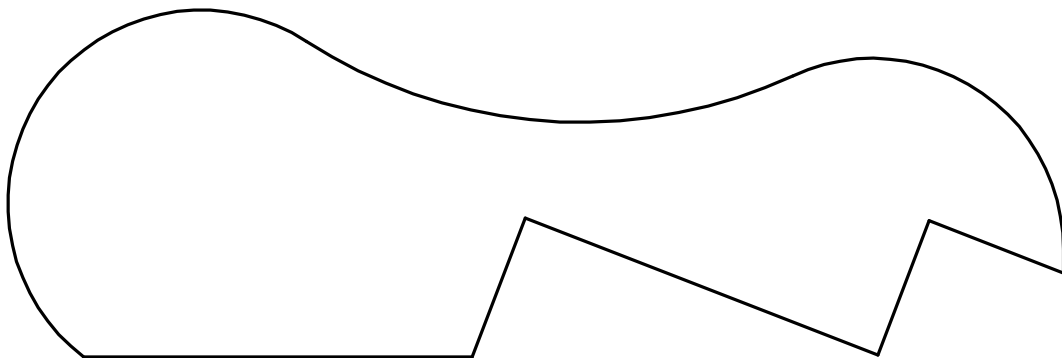

HM258

1 13/16" x 5 1/2"

**HURDER
MILLWORK**



HM259
6" x 2 7/16"

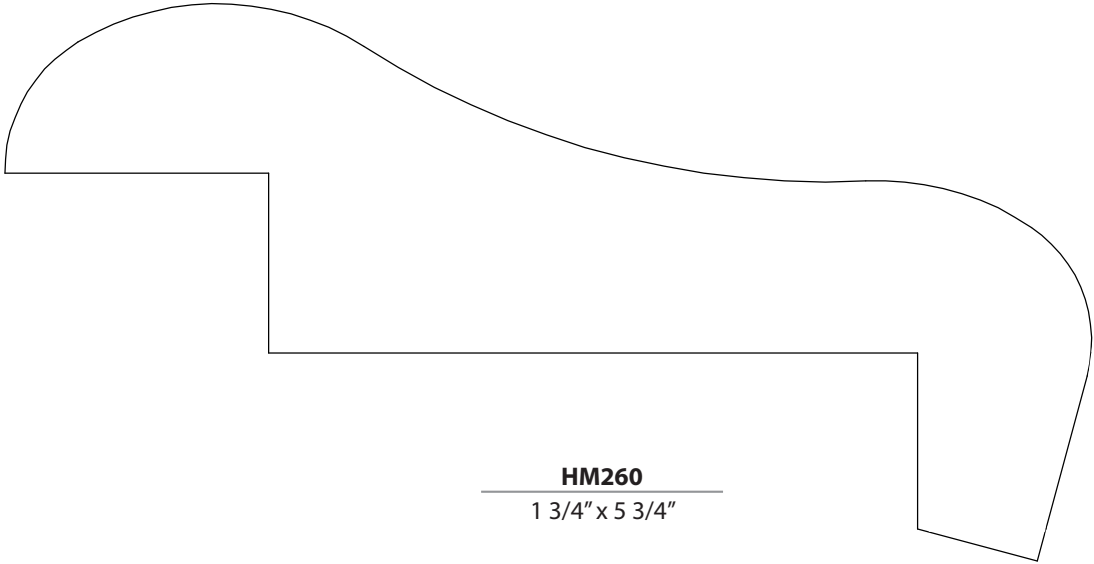

HM260
1 3/4" x 5 3/4"

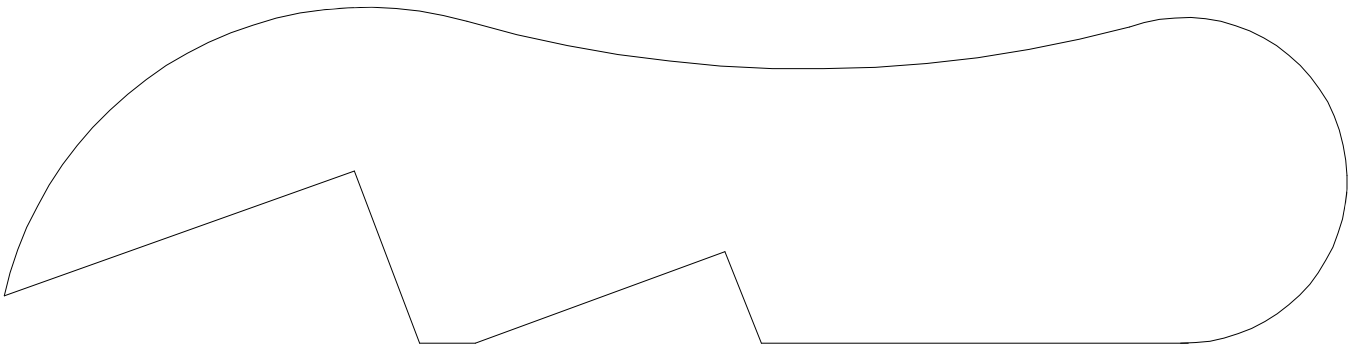

HM261
1 3/4" x 7"

**HURDER
MILLWORK**

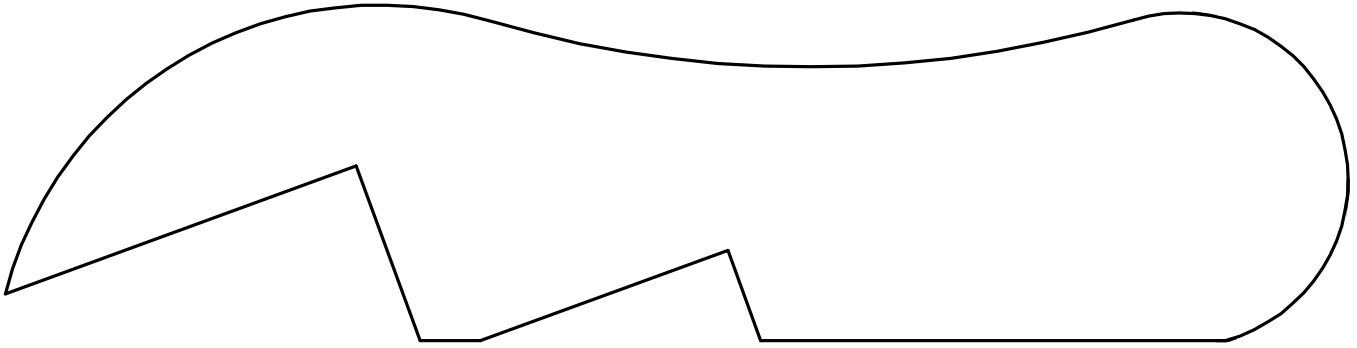

HM262
1 23/32" x 7"

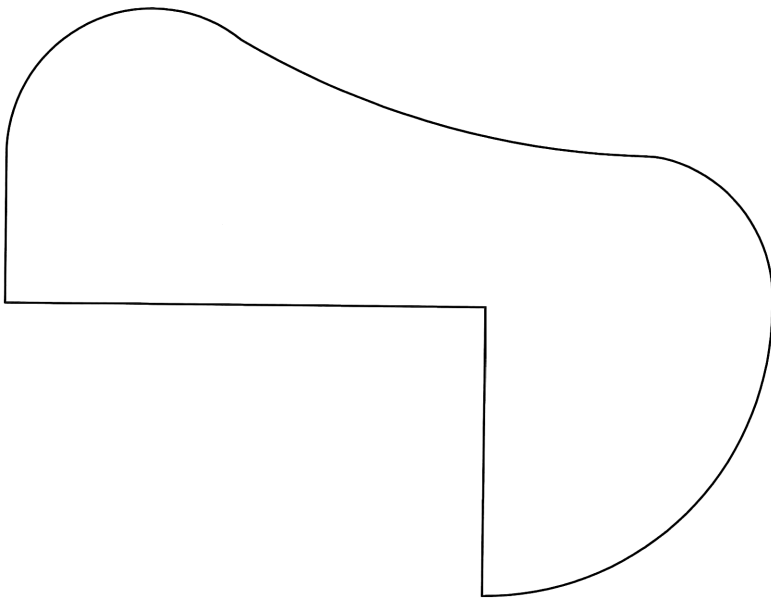

HM263
4" x 3 1/16"



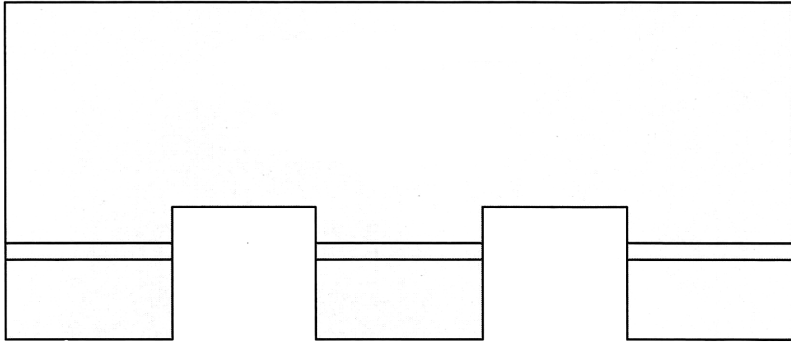

Front View

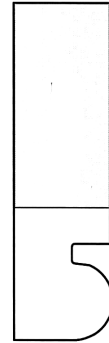

Side View

HM267
1/2" x 1 3/4"

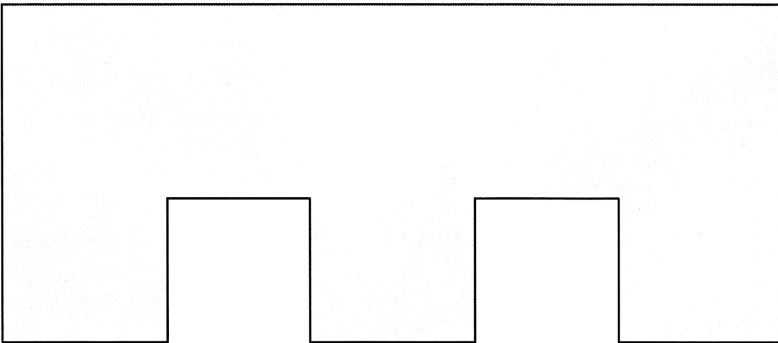

Front View

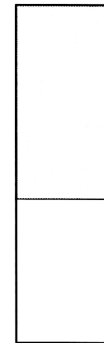

Side View

HM268
1/2" x 1 3/4"

HURDER MILLWORK



IN-STOCK

HM270
1" x 4 1/2"



IN-STOCK

HM271
1" x 4 1/2"



HM272
1" x 4 1/2"



HM273
1" x 3 3/4"

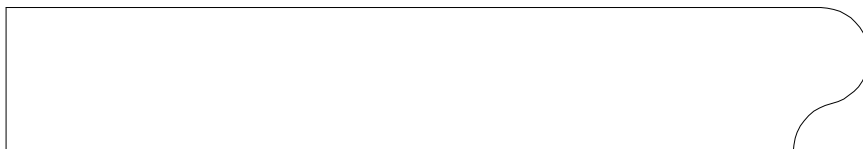

HM274
3/4" x 4 1/2"

HURDER MILLWORK

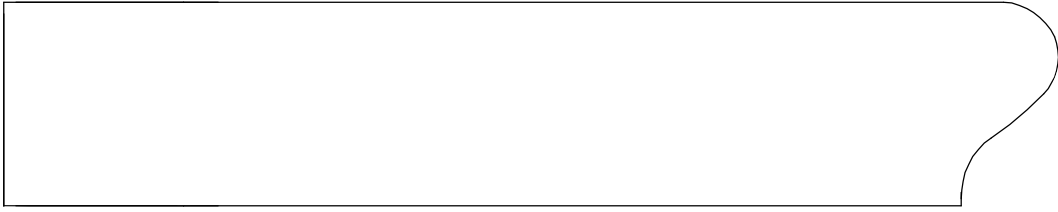

HM275

1 1/16" x 5 1/2"

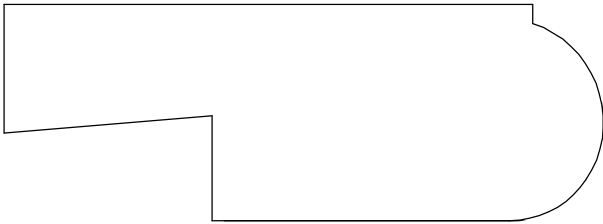

HM276

1 1/8" x 3 1/8"



HM277

1" x 3 1/4"

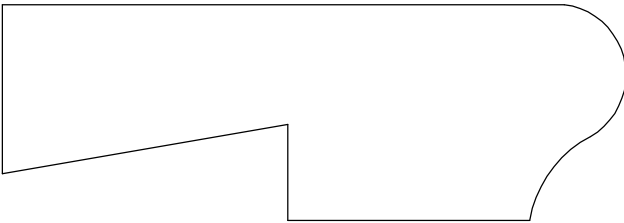

HM278

1 1/8" x 3 1/4"

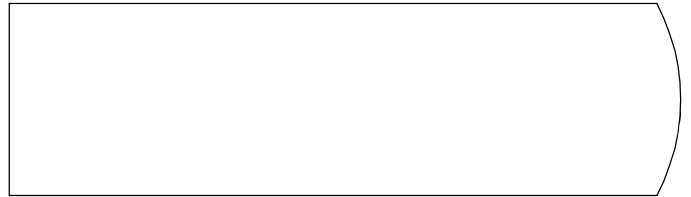

HM279

1" x 3 1/2"

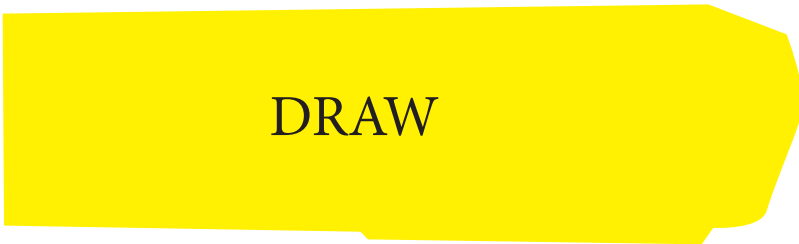

DRAW

HM280

3/4" x 4 1/2"

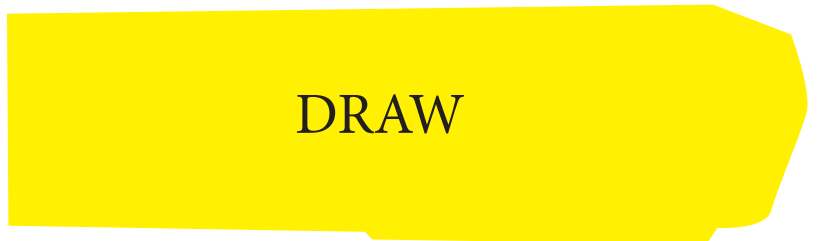

DRAW

HM281

3/4" x 4 1/2"

HURDER MILLWORK

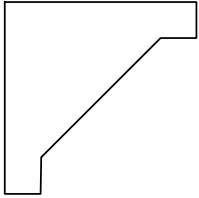

HM285

1" x 1"

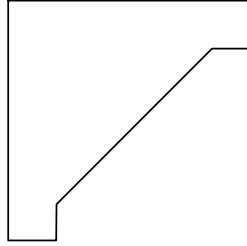

HM286

1 1/4" x 1 1/4"

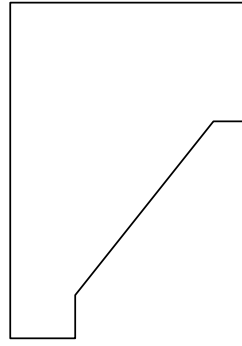

HM287

1 1/4" x 1 3/4"

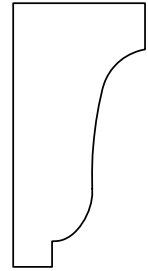

HM288

1 1/16" x 1 3/8"

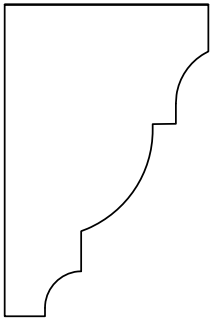

HM289

1 1/16" x 1 5/8"

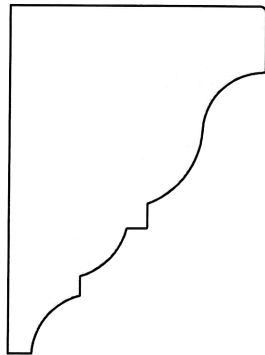

HM290

1 5/16" x 1 13/16"

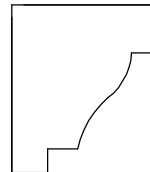

HM291

3/4" x 7/8"

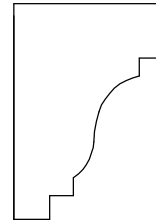

HM292

3/4" x 1 1/8"

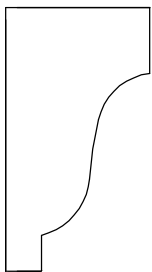

HM293

3/4" x 1 3/8"



HM294

1 5/32" x 1 3/8"

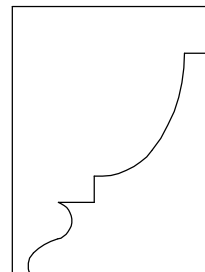

HM295

1 1/16" x 1 13/32"

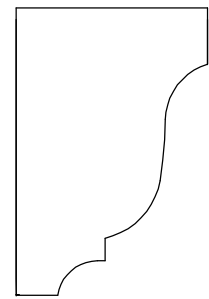

HM296

1" x 1 1/2"

HURDER MILLWORK

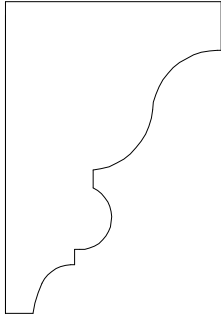

HM297

1 1/8" x 1 5/8"

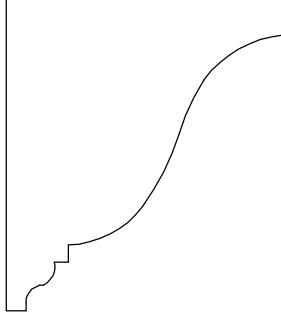

HM298

1 7/16" x 1 5/8"

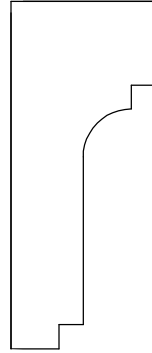

HM299

3/4" x 1 13/32"

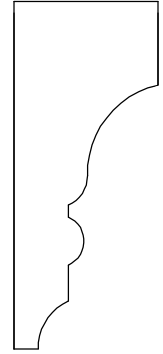

HM366

3/4" x 1 13/16"

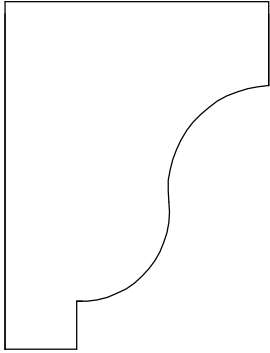

HM367

1 3/8" x 1 13/16"

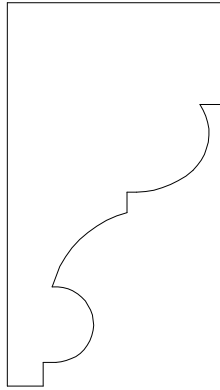

HM368

1 1/8" x 2"

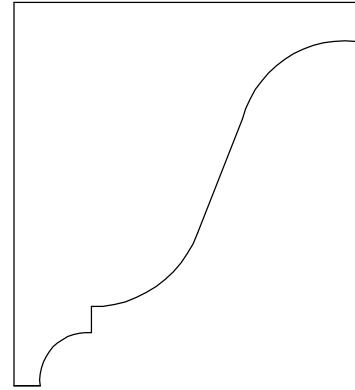

HM369

1 25/32" x 2"

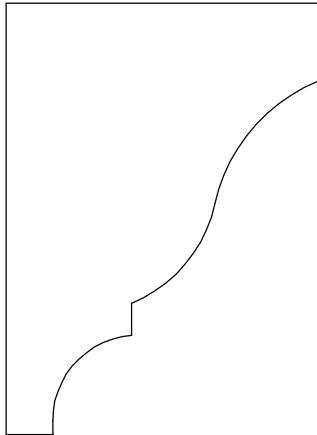

HM370

1 5/8" x 2 1/4"

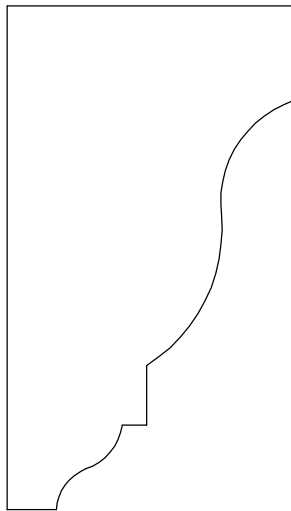

HM371

1 1/2" x 2 5/8"

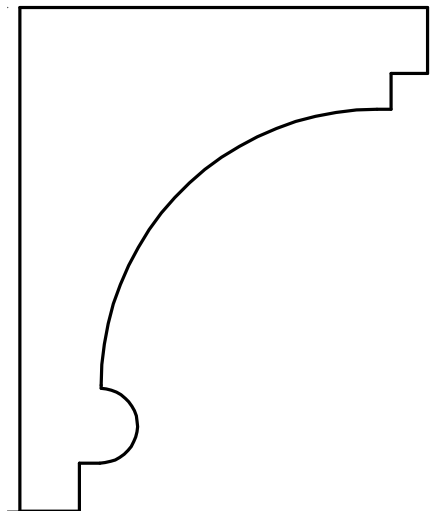

HM372

2 1/8" x 2 5/8"

HURDER MILLWORK



HM373
1 3/8" x 2 3/4"

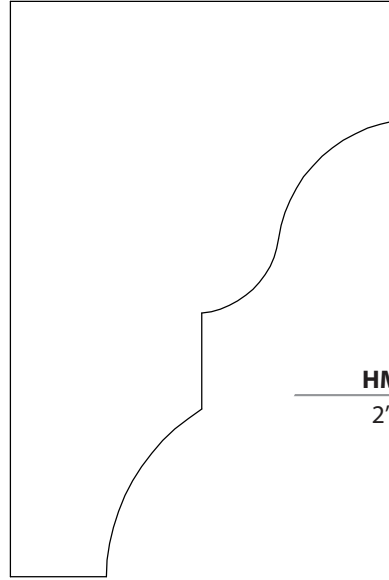

HM374
2" x 3"

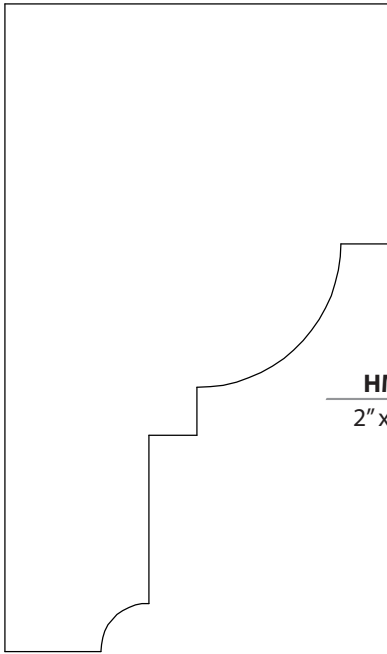

HM375
2" x 3 3/8"

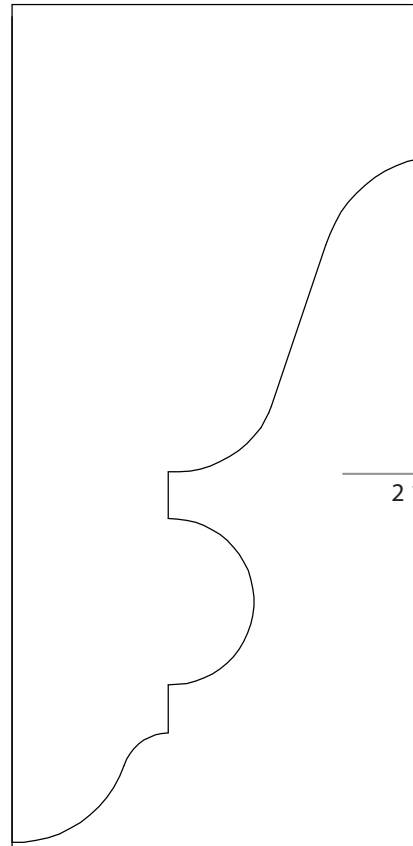

HM376
2 1/8" x 5 3/4"

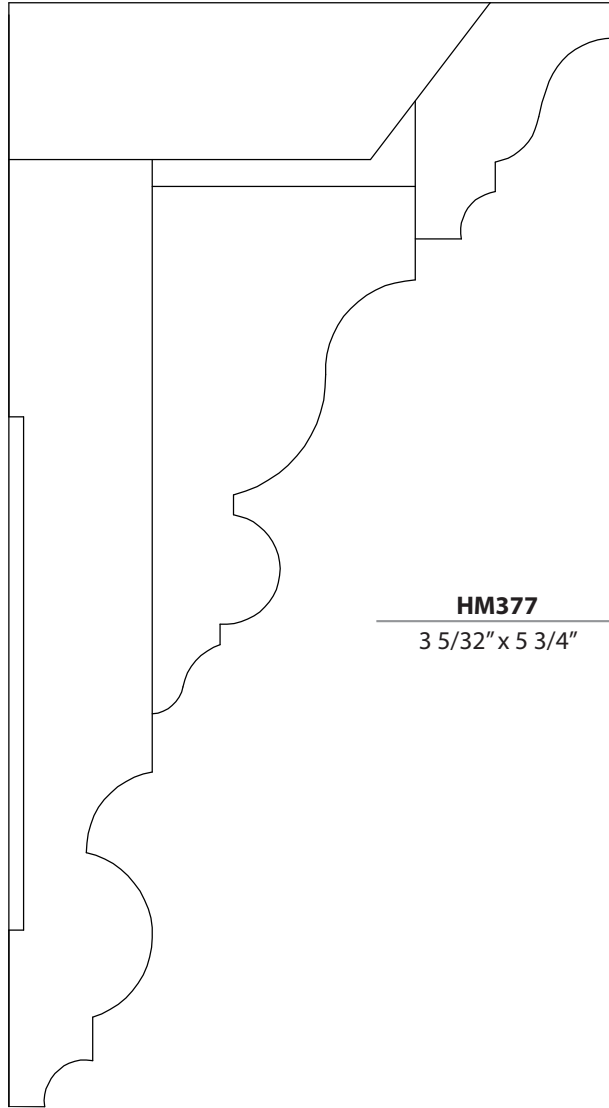

HM377

3 5/32" x 5 3/4"



HURDER MILLWORK

www.HurderMillwork.com

SHELF EDGE PROFILES



HURDER MILLWORK

IN-STOCK

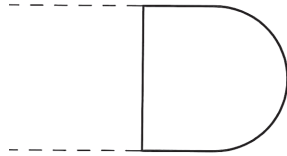

HM300

3/4" x 3/4"

IN-STOCK

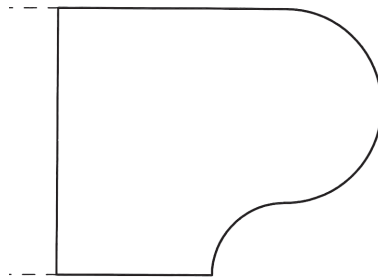

HM301

1 11/16" x 1 3/8"

IN-STOCK

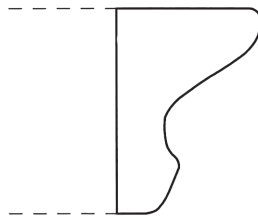

HM302

3/4" x 1 1/16"

IN-STOCK

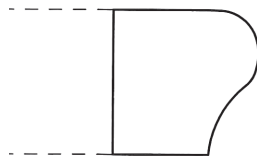

HM303

3/4" x 3/4"



HURDER MILLWORK

www.HurderMillwork.com

**WAINSCOT
PROFILES**



HURDER MILLWORK

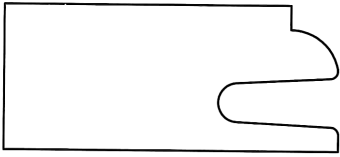

HM301
1 3/4" x 3/4"

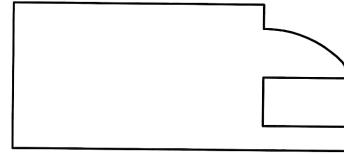

HM302
1 3/4" x 3/4"

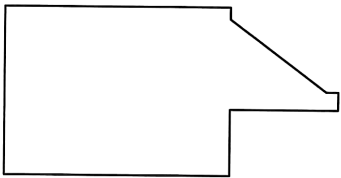

HM303
1 3/4" x 7/8"

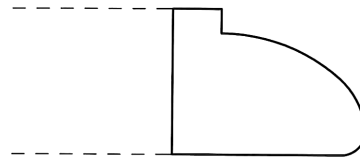

HM304
2 1/4" x 7/8"

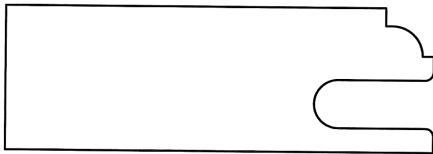

HM305
2 1/4" x 3/4"

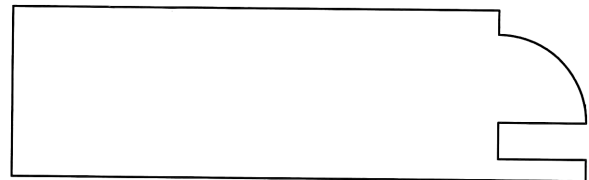

HM306
3" x 7/8"

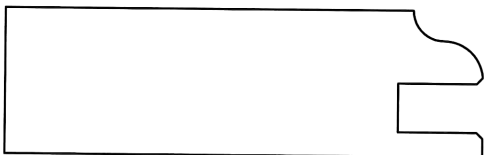

HM307
2 1/2" x 3/4"

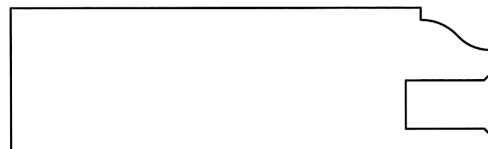

HM308
2 1/2" x 3/4"

HURDER MILLWORK

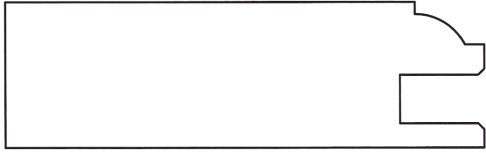

HM309
2 1/2" x 3/4"

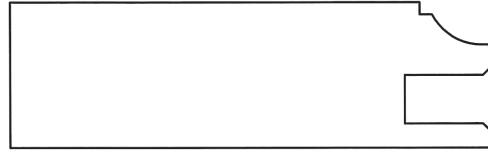

HM310
2 1/2" x 3/4"

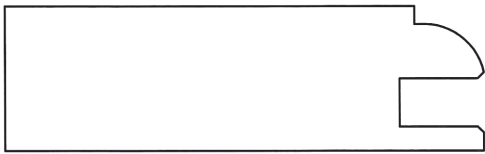

HM311
2 1/2" x 3/4"



HM312
2 1/2" x 3/4"

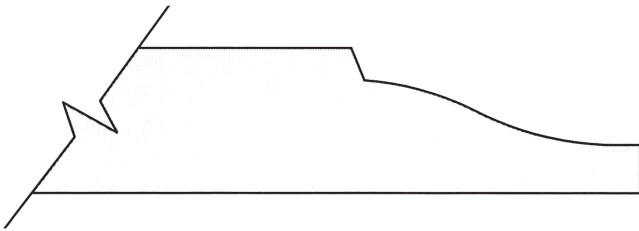

IN-STOCK

HM313
3/4" x 1 1/2"

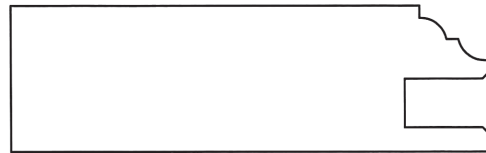

IN-STOCK

HM314
1 3/8" x 1/2"

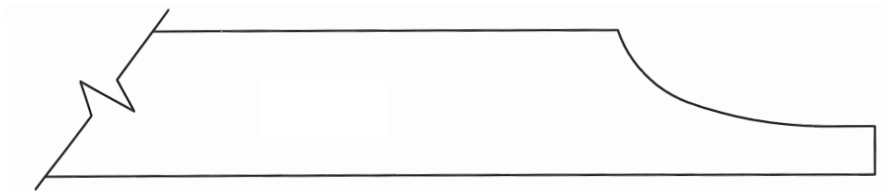

HM315
1 5/16" x 3/4"

HURDER MILLWORK

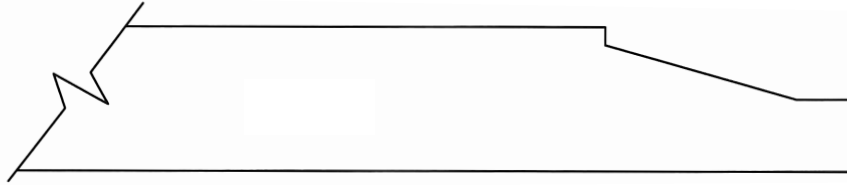

HM316

1 5/16" x 3/4"

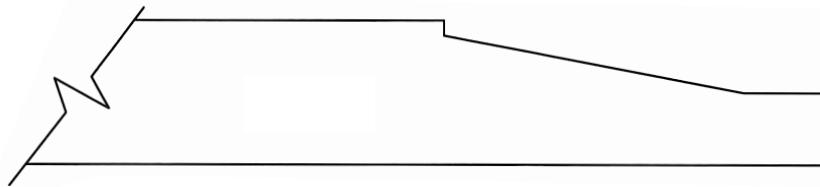

HM317

2" x 3/4"

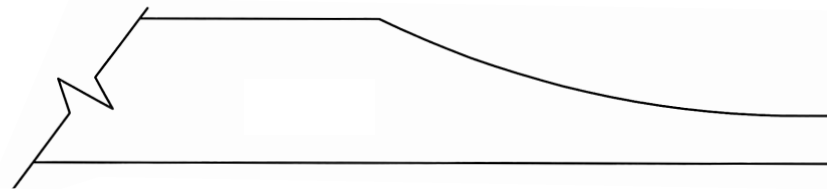

HM318

2 3/8" x 3/4"



HM319

5 1/4" x 3/4"
6" Repeat



HM320

3 1/2" x 1/2"
3 1/4" Repeat

HURDER MILLWORK

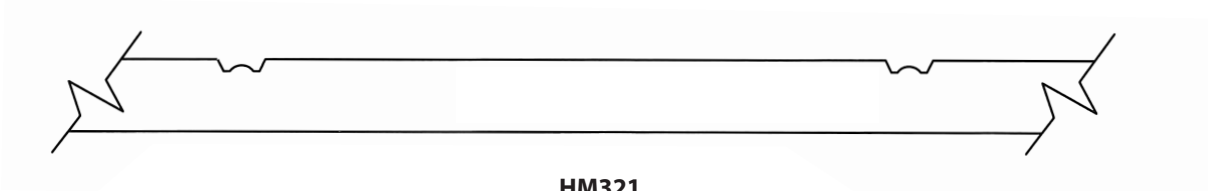

HM321

48" x 3/8"
3 1/2" Repeat



HM322

1/2" x 2 25/32"



HM323

1/2" x 2 7/8"



HM324

3/8" x 3 1/4"



HM325

7/16" x 3 1/4"



HM326

7/16" x 3 1/4"

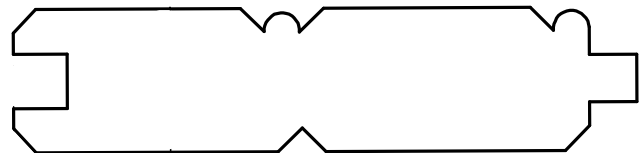

HM327

3/4" x 3 1/4"



HM328

1/2" x 3 15/16"



HM329

1/2" x 3 3/4"

HURDER MILLWORK

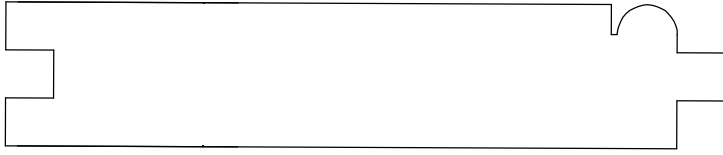

HM330

3/4" x 3 3/4"

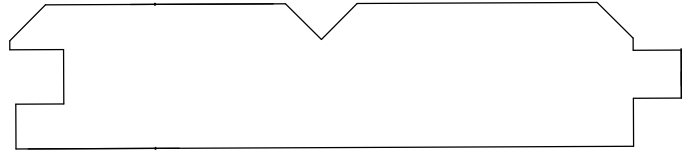

HM331

3/4" x 3 1/2"

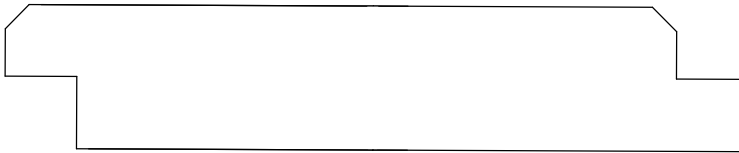

HM332

3/4" x 3 7/8"



HM333

5/8" x 4 1/4"

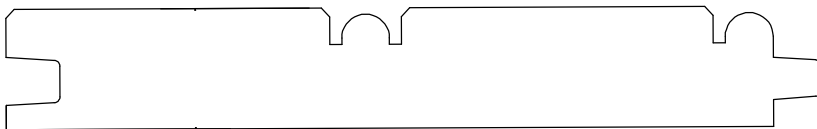

HM334

5/8" x 4 1/4"



HM335

3/4" x 4 1/4"

HURDER MILLWORK

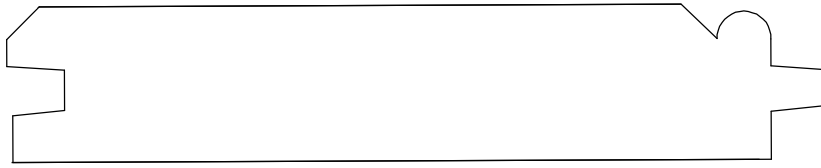

HM336
13/16" x 4 1/4"

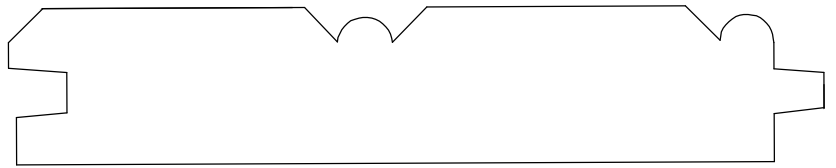

HM337
13/16" x 4 1/4"

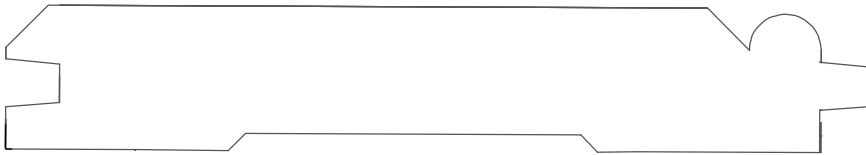

HM338
3/4" x 4 1/2"



HM339
3/4" x 4 1/2"



HM340
9/16" x 5"

HURDER MILLWORK



HM341

3/4" x 5 1/2"

IN-STOCK

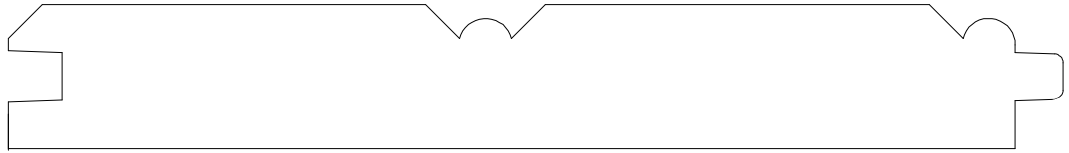

HM342

3/4" x 5 1/2"



HM343

3/4" x 5 1/2"

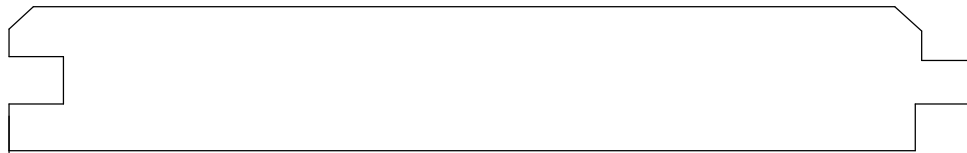

HM344

3/4" x 5"

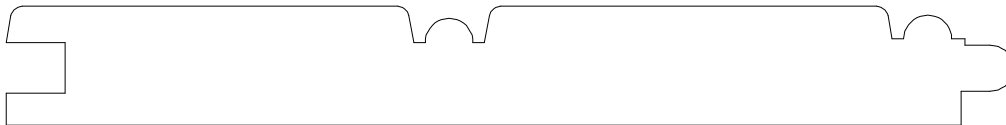

HM345

5/8" x 5 1/4"

HURDER MILLWORK

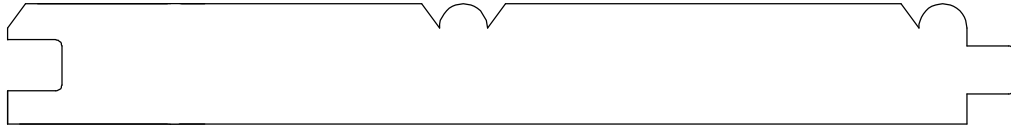

HM346

5/8" x 5 1/4"

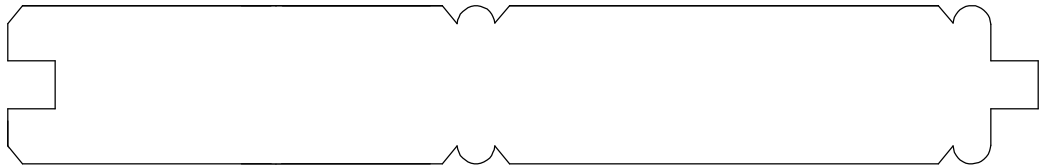

HM347

13/16" x 5 3/8"



HM348

1/2" x 6 1/8"



HM349

7/8" x 7 1/8"

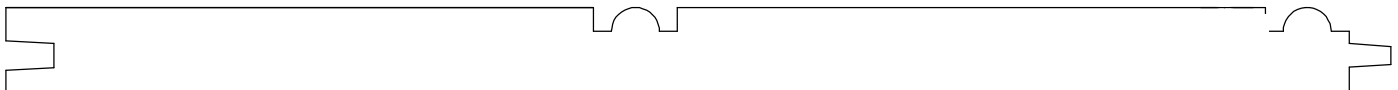

HM350

7/16" x 7 7/32"

**HURDER
MILLWORK**

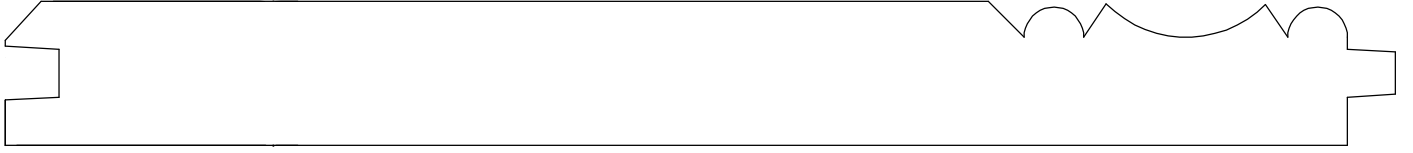

HM351
3/4" x 7 1/4"

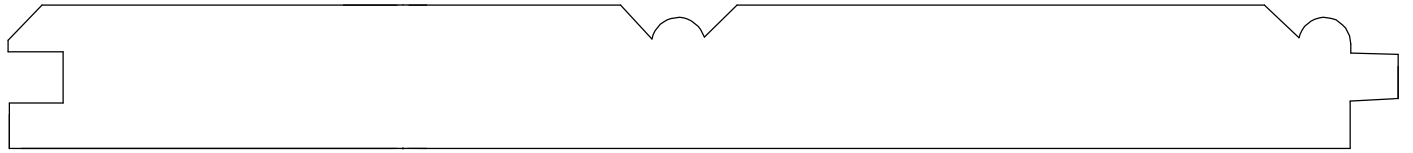

HM352
3/4" x 7 1/4"



HM353
3/4" x 7 1/2"



HM354
13/16" x 7 5/8"

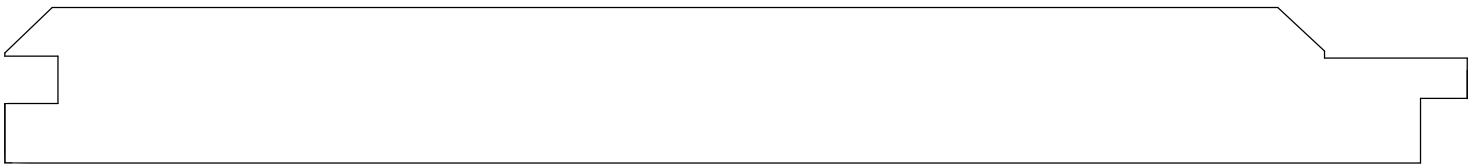

HM355
123/32" x 9 1/4"



**HURDER
MILLWORK**

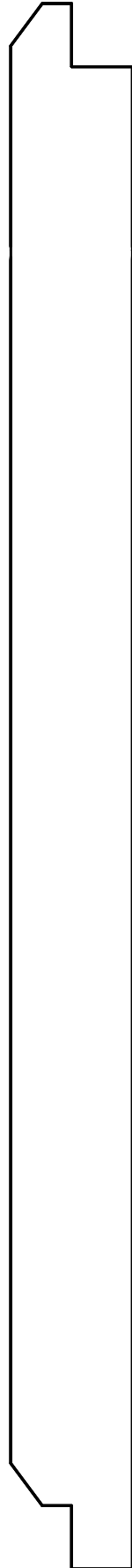

HM355

123/32" x 9 1/4"



HURDER MILLWORK

www.HurderMillwork.com

BACK BAND PROFILES



HURDER MILLWORK

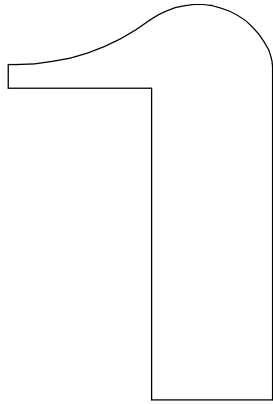

HM421

2 3/8" x 2 1/16"

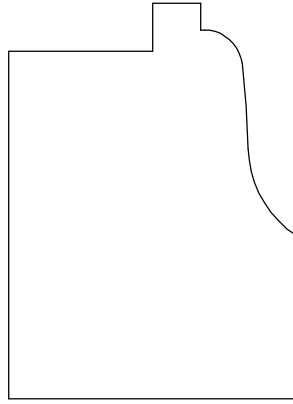

HM422

1 1/2" x 2 1/16"

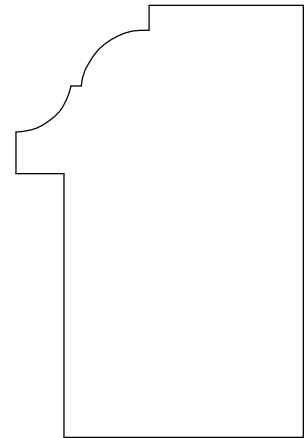

HM423

1 1/2" x 2 1/4"

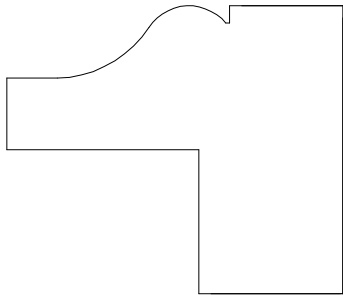

HM424

1 5/8" x 2 3/8"

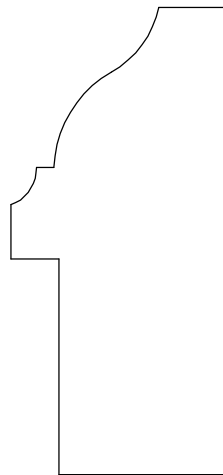

HM425

1 1/8" x 2 7/16"

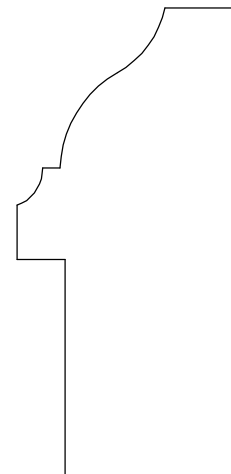

HM425

1 1/8" x 2 7/16"

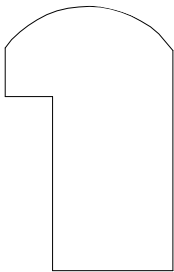

HM426

7/8" x 1 3/8"

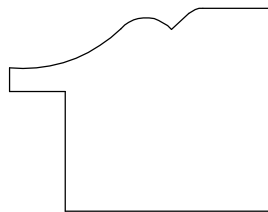

HM427

1 1/16" x 1 3/8"

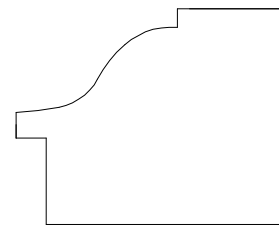

HM428

1 1/8" x 1 3/8"

HURDER MILLWORK

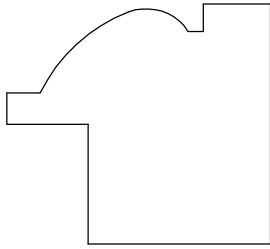

HM429

1 1/4" x 1 3/8"

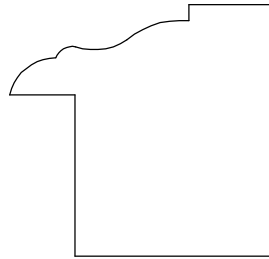

HM430

1 5/16" x 1 3/8"

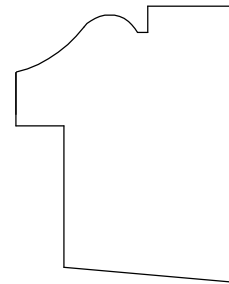

HM431

1 1/8" x 1 37/16"

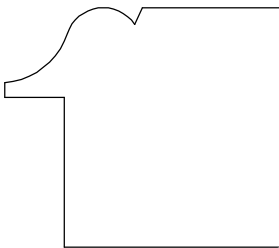

HM432

1 1/4" x 1 7/16"

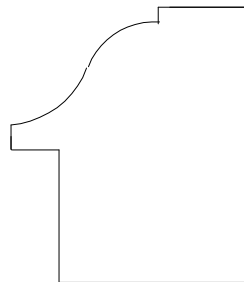

HM433

1 1/4" x 1 7/16"

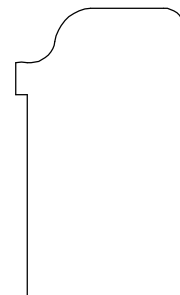

HM434

7/8" x 1 1/2"

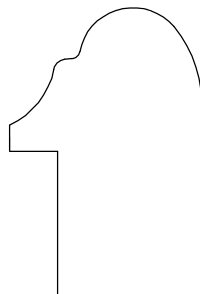

HM435

1" x 1 1/2"

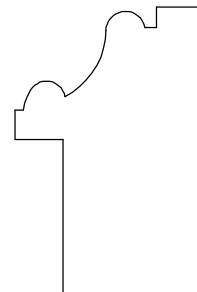

HM436

1" x 1 1/2"

**HURDER
MILLWORK**

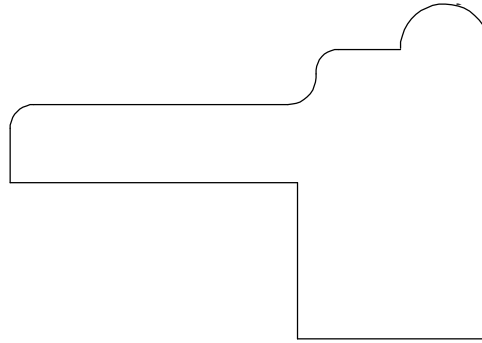

HM437
1 3/4" x 2 1/2"

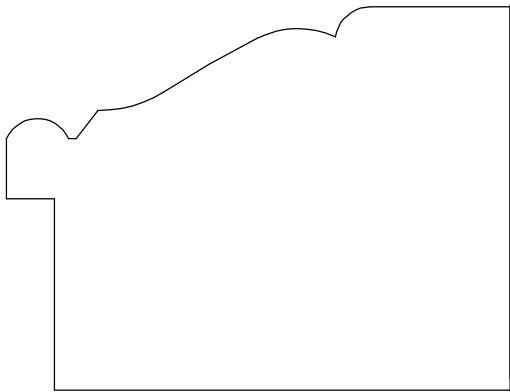

HM438
2" x 2 5/8"

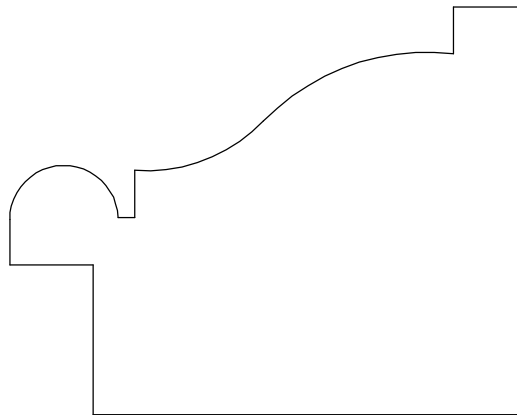

HM439
2 1/8" x 2 11/16"

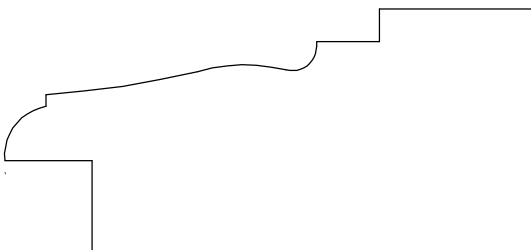

HM440
1 1/4" x 2 3/4"

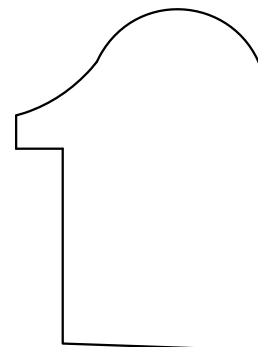

HM441
1" x 1 3/8"

HURDER MILLWORK

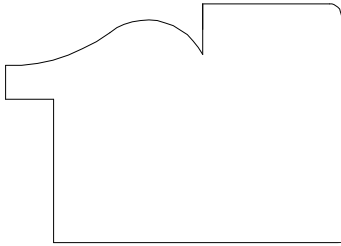

HM442
1 1/4" x 1 1/4"

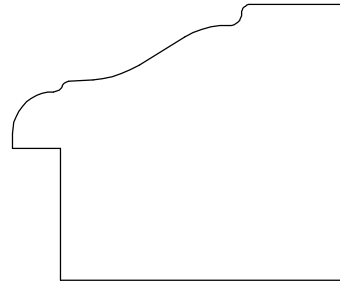

HM443
1 7/16" x 1 3/4"

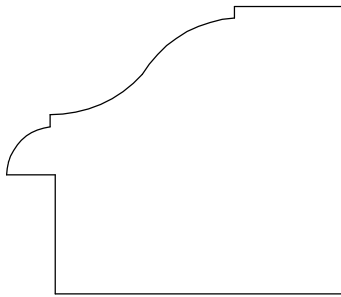

HM444
1 1/2" x 1 3/4"

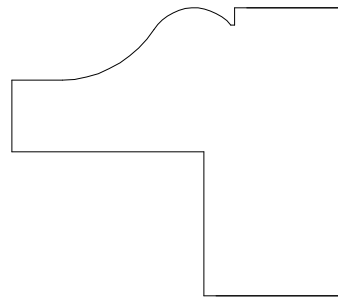

HM445
1 1/2" x 1 3/4"

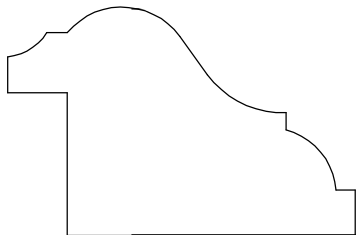

HM446
1 3/16" x 1 13/16"

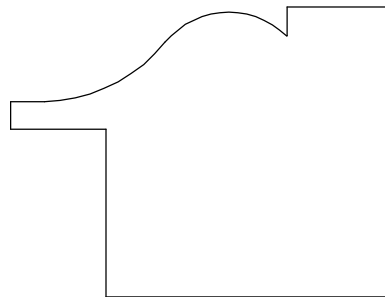

HM447
1 1/2" x 2"

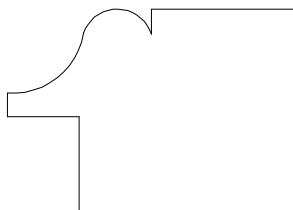

HM448
1 1/16" x 1 1/2"

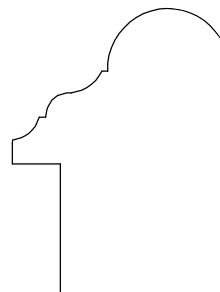

HM449
1 1/8" x 1 1/2"

HURDER MILLWORK

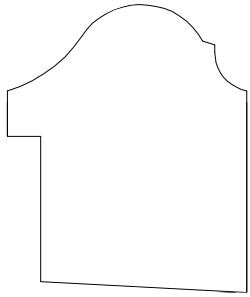

HM450
1 1/4" x 1 1/2"

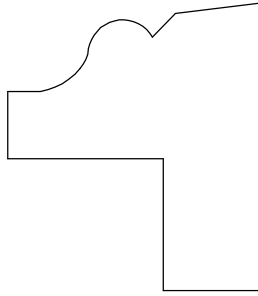

HM451
1 5/16" x 1 1/2"

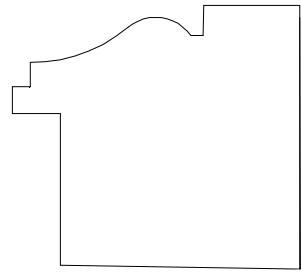

HM452
1 3/8" x 1 1/2"

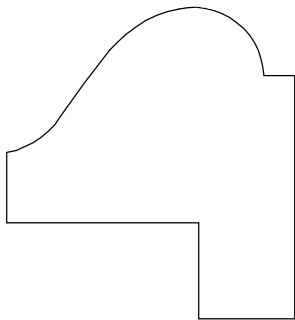

HM453
1 5/8" x 1 1/2"

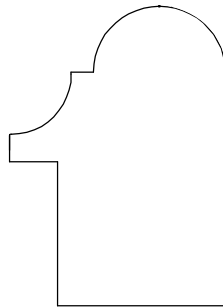

HM454
1 1/8" x 1 9/16"

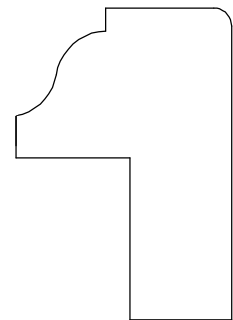

HM455
1 1/8" x 1 5/8"

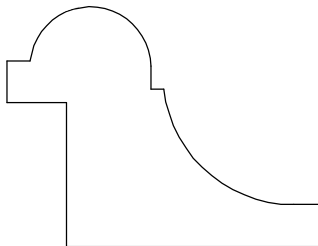

HM456
1 1/4" x 1 5/8"

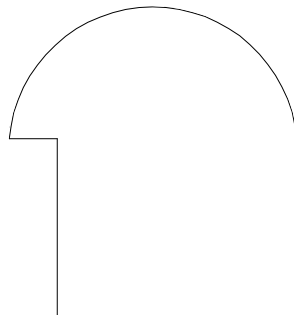

HM457
1 1/2" x 1 5/8"

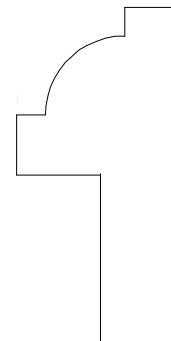

HM458
13/16" x 1 3/4"

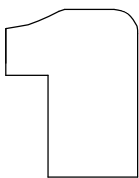

HM459
1 1/16" x 7/8"

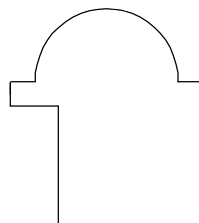

HM460
1 1/8" x 1"

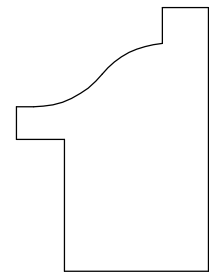

HM461
1 3/8" x 1"

HURDER MILLWORK

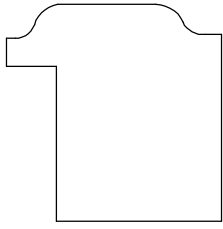

HM462

1 1/8" x 1 1/8"

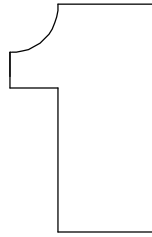

HM463

3/4" x 1 3/16"

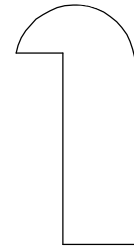

HM464

5/8" x 1 1/4"

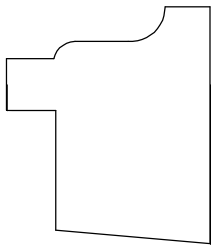

HM465

1 1/16" x 1 1/4"

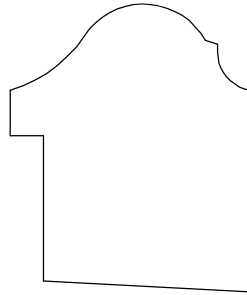

HM466

1 1/2" x 1 1/4"

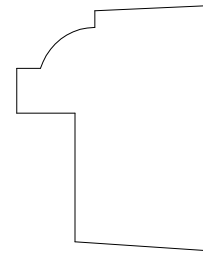

HM467

1" x 1 9/32"

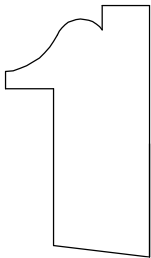

HM468

3/4" x 1 5/16"

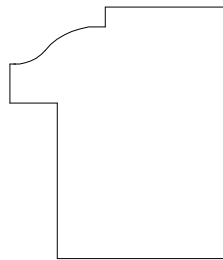

HM469

1 1/8" x 1 5/16"

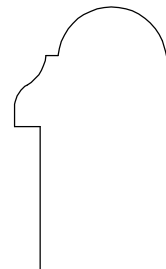

HM470

13/16" x 1 3/8"

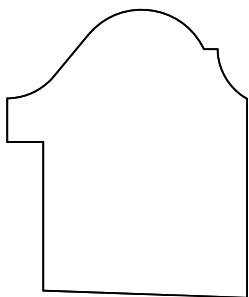

HM471

1 1/4" x 1 1/2"

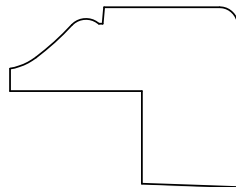

HM472

7/8" x 1 3/16"

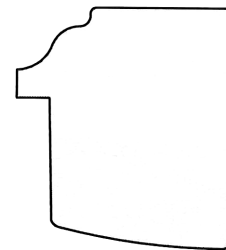

HM473

1 1/8" x 1 1/4"

HURDER MILLWORK

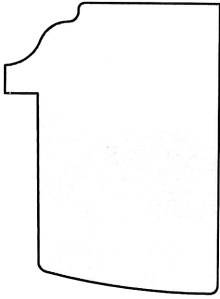

HM474

1 1/8" x 1 1/2"

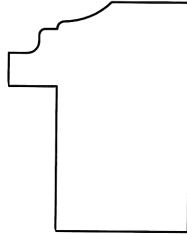

HM475

15/16" x 1 3/16"

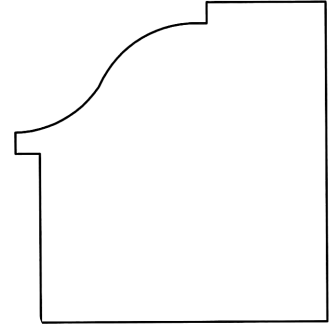

HM476

1 5/8" x 1 11/16"

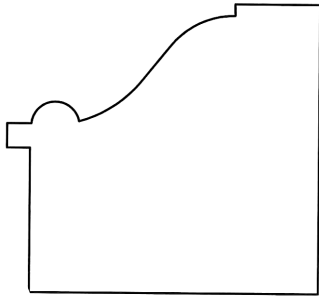

HM477

1 5/8" x 1 1/2"

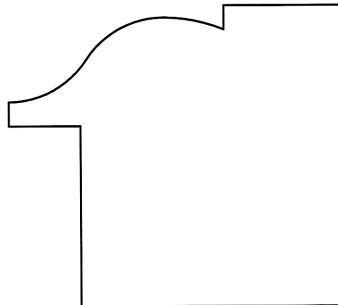

HM478

1 3/4" x 1 9/16"

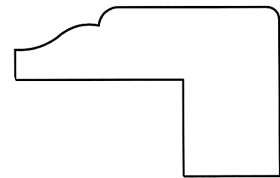

HM479

1 3/8" x 7/8"



HURDER MILLWORK

www.HurderMillwork.com

CHAIR RAIL & ASTRAGAL PROFILES



HURDER MILLWORK

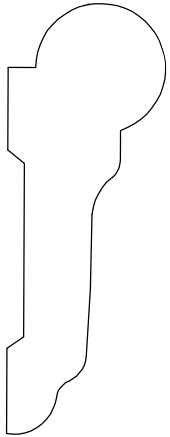

IN-STOCK

HM500

13/16" x 2 1/4"

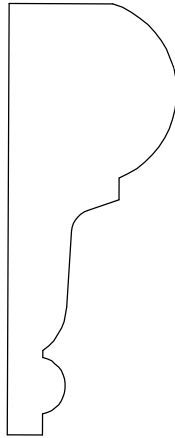

IN-STOCK

HM501

7/8" x 2 1/4"

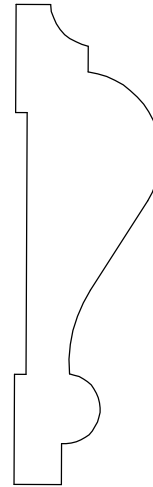

IN-STOCK

HM502

3/4" x 2 1/2"

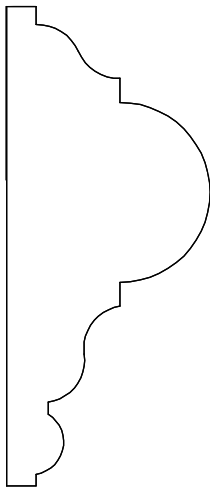

IN-STOCK

HM503

1 1/16" x 2 1/2"

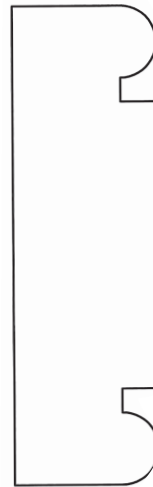

IN-STOCK

HM504

3/4" x 2 1/2"

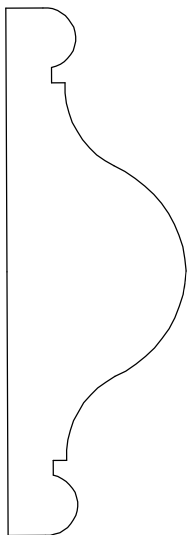

HM505

15/16" x 2 3/4"

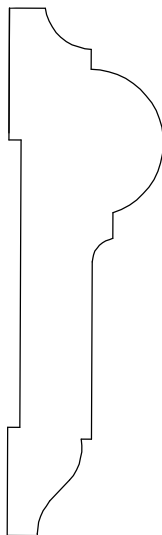

HM506

13/16" x 2 3/4"

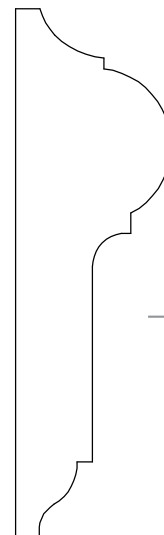

HM507

13/16" x 2 3/4"

HURDER MILLWORK

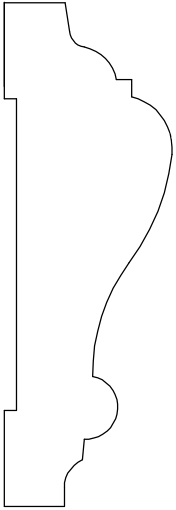

HM508
7/8" x 2 5/8"

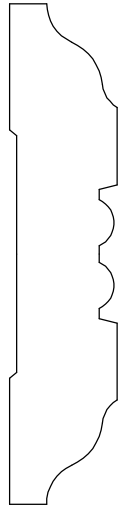

HM509
9/16" x 2 5/8"

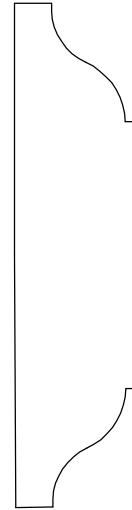

HM510
5/8" x 2 5/8"



HM511
1 1/16" x 2 5/8"

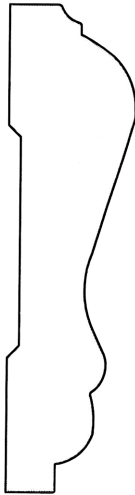

HM512
5/8" x 2 7/16"

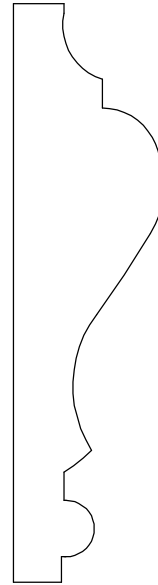

HM517
1 3/16" x 3"

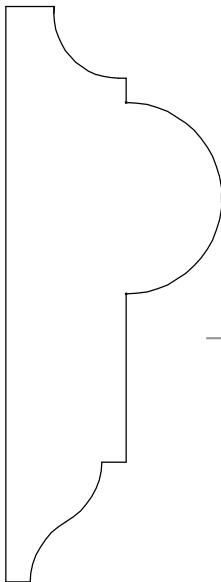

HM518
1 1/8" x 3"

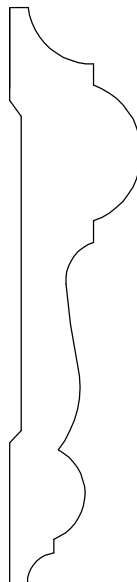

HM519
1 1/16" x 3"

HURDER MILLWORK

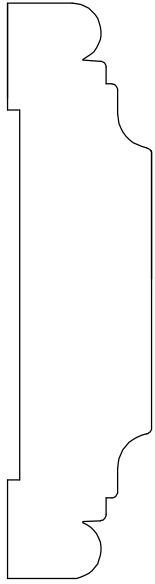

HM520

3/4" x 3"

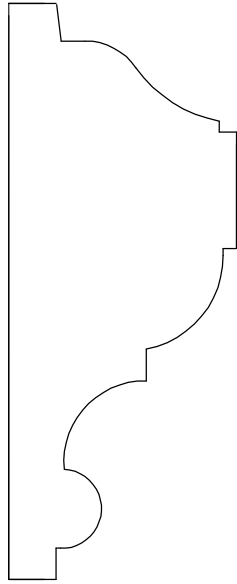

HM521

1 3/16" x 3"

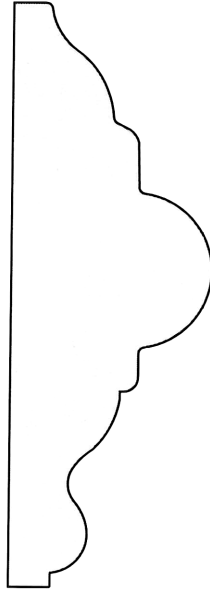

HM522

1" x 3"

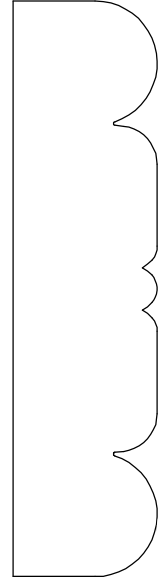

HM523

3/4" x 3"

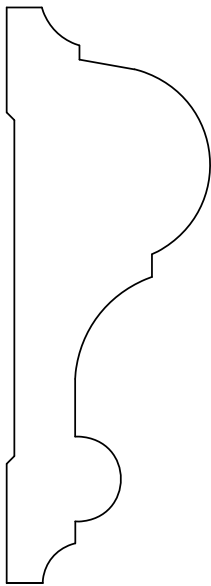

HM524

1 1/16" x 3"

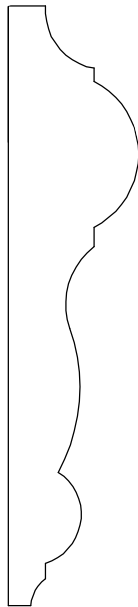

HM525

1 1/16" x 3 1/8"

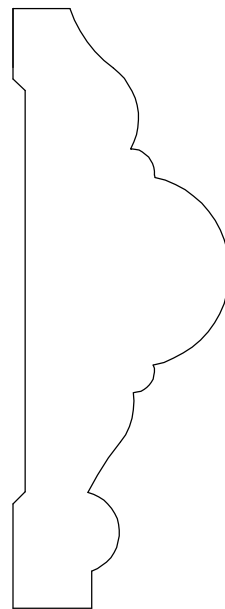

HM526

1 1/8" x 3 1/8"

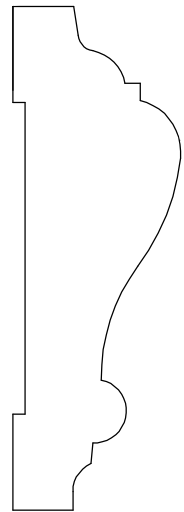

HM527

7/8" x 2 5/8"

HURDER MILLWORK

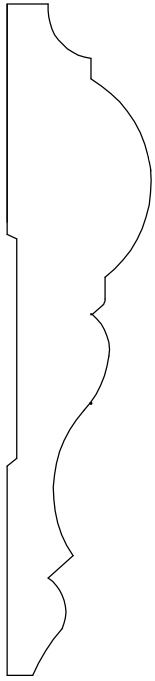

HM528

3/4" x 3 1/2"

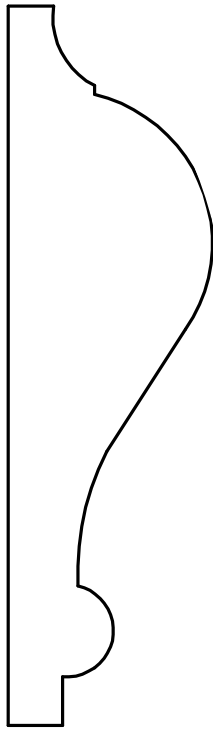

HM529

1 1/16" x 3 3/4"

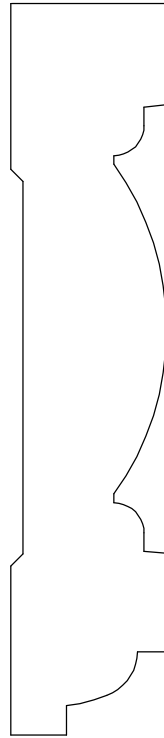

HM530

13/16" x 3 13/16"

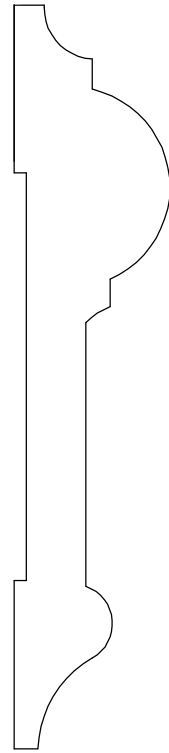

HM531

13/16" x 3 7/8"

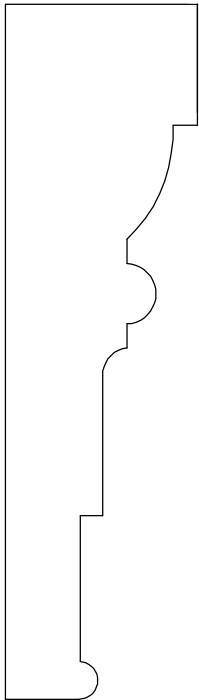

HM532

1" x 3 5/8"

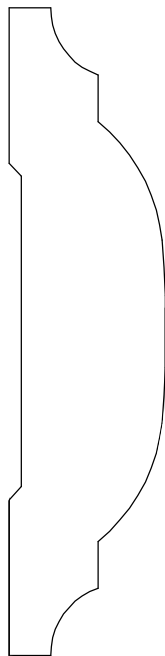

HM533

13/16" x 3 3/8"

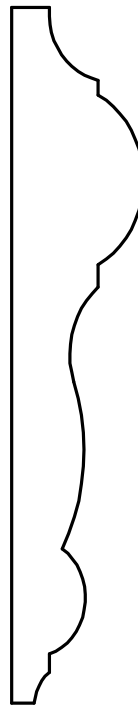

HM534

131/16" x 3 5/8"

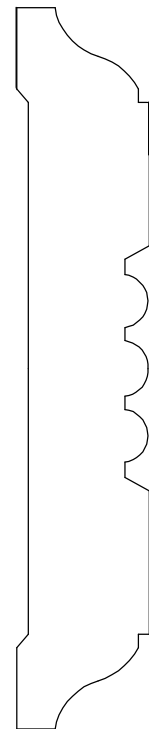

HM535

11/16" x 3 3/4"

HURDER MILLWORK

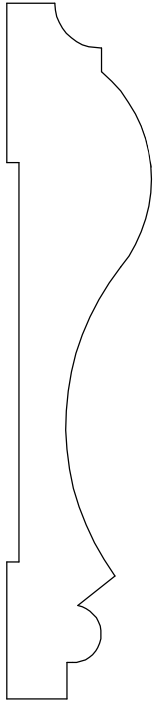

HM536

3/4" x 3 5/8"

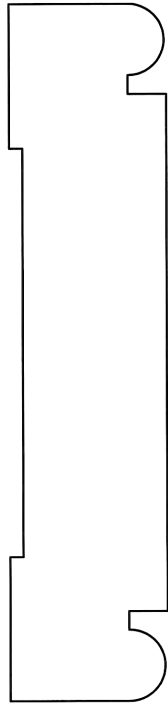

HM537

13/16" x 3 5/8"

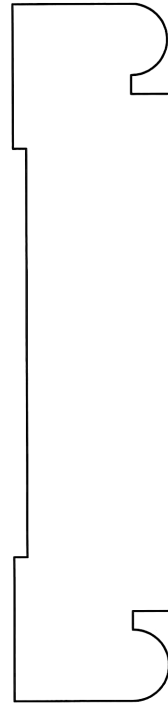

HM537

13/16" x 3 5/8"

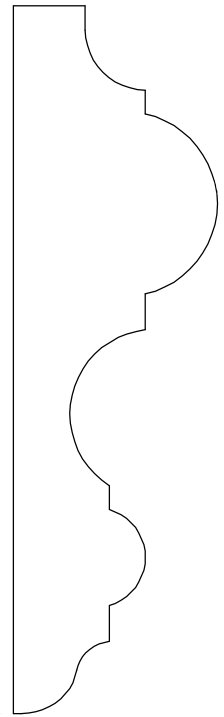

HM538

11/16" x 3 11/16"

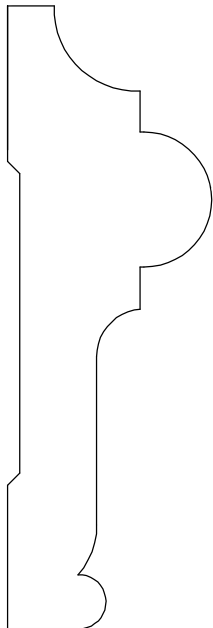

HM539

1 1/16" x 3 1/4"

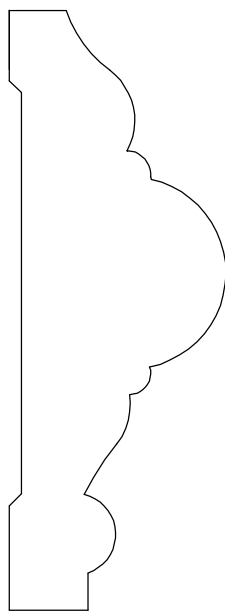

HM540

1 1/4" x 3 1/2"



HM541

3/4" x 3 1/2"

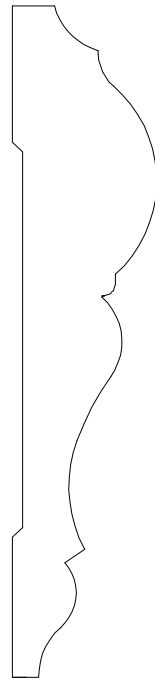

HM542

3/4" x 3 1/2"

HURDER MILLWORK

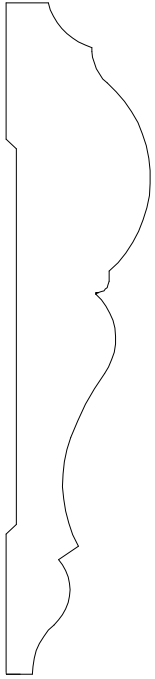

HM542

3/4" x 3 1/2"

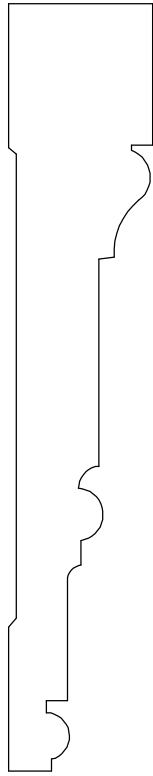

HM547

3/4" x 4"

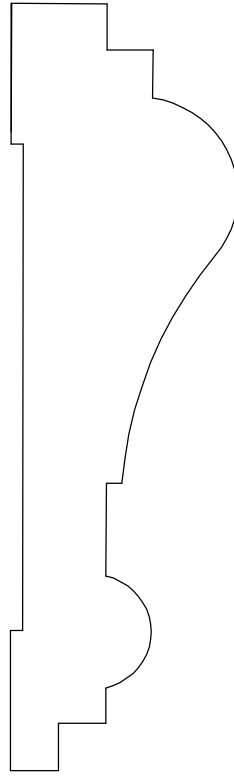

HM548

1 3/16" x 4"

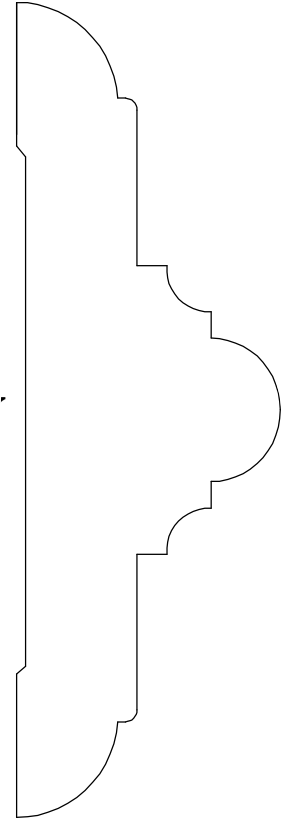

HM549

1 3/8" x 4 1/4"

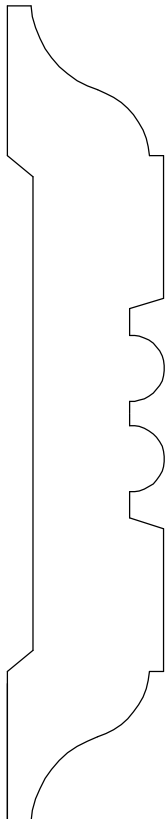

HM550

13/16" x 4 1/4"

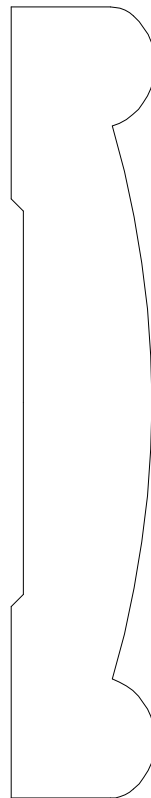

HM551

3/4" x 4 1/8"

**HURDER
MILLWORK**

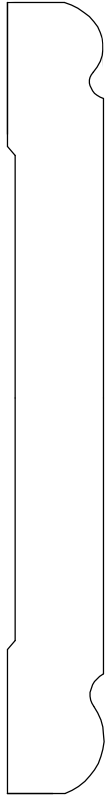

HM552
1/2" x 4 1/8"

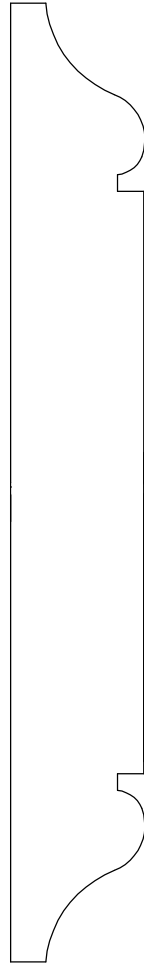

HM553
11/16" x 5"

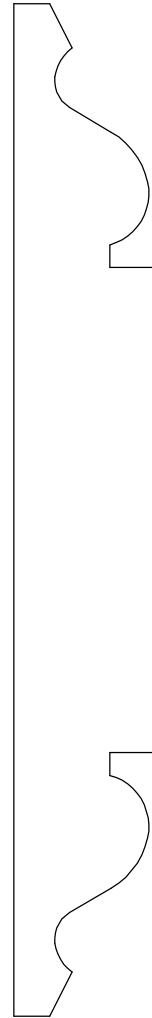

HM554
11/16" x 5 4/32"

HURDER MILLWORK

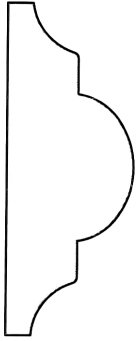

HM560
1 3/4" x 5/8"

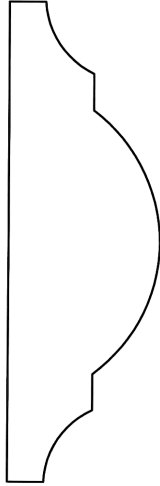

HM561
2 1/2" x 13/16"



HM562
1/4" x 1/2"



HM563
3/4" x 7/16"

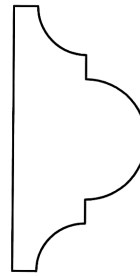

HM564
1 3/8" x 11/16"



HM565
5/8" x 5/16"

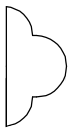

HM566
5/16" x 5/8"

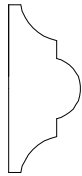

HM567
3/8" x 7/8"

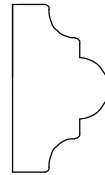

HM568
1/2" x 7/8"



HM569
1/4" x 3/4"



HM570
3/8" x 3/4"

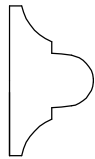

HM571
7/16" x 25/32"

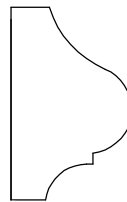

HM575
5/8" x 1"

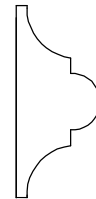

HM576
7/16" x 1"

HURDER MILLWORK

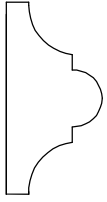

HM577
1/2" x 1"

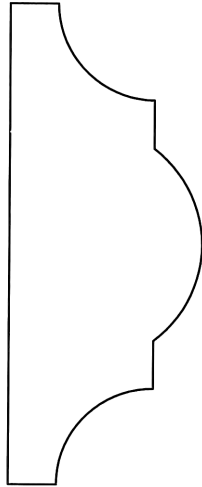

HM578
2 2/2" x 1"



HM579
15/32" x 1 1/8"

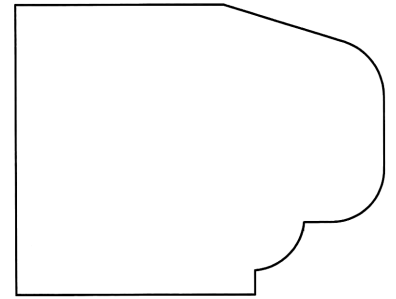

HM580
1 15/16" x 1 1/2"

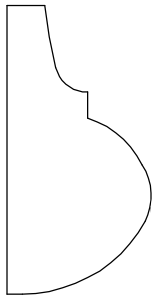

HM581
3/4" x 1 1/2"

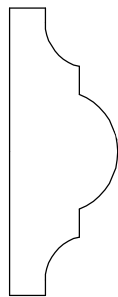

HM582
9/16" x 1 1/2"

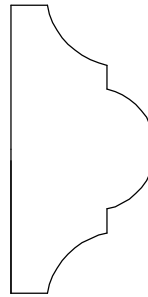

HM583
3/4" x 1 1/2"



HM584
9/16" x 1 1/4"

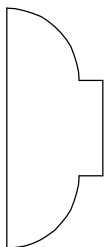

HM585
1/2" x 1 1/4"

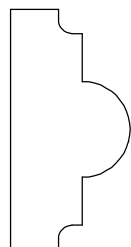

HM586
5/8" x 1 1/4"

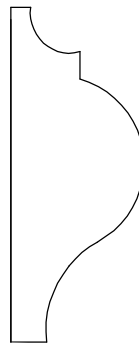

HM587
11/16" x 1 3/4"

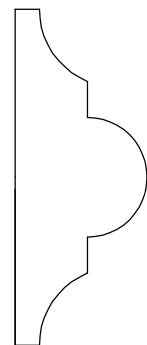

HM588
11/16" x 1 3/4"

HURDER MILLWORK

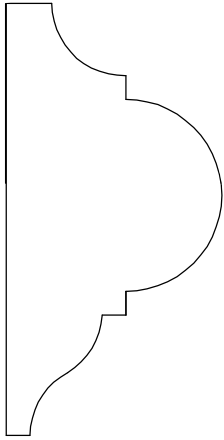

HM589

1 1/8" x 2 1/4"

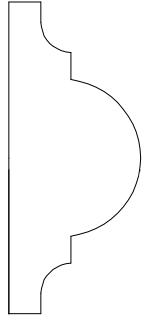

HM590

1 1/16" x 1 5/8"

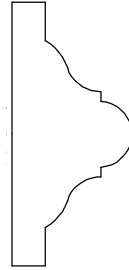

HM591

5/8" x 1 3/8"

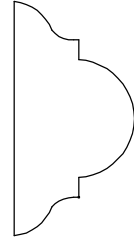

HM592

5/8" x 1 7/32"

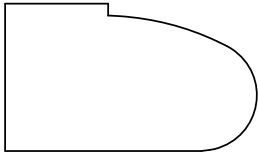

HM593

25/32" x 1 5/16"

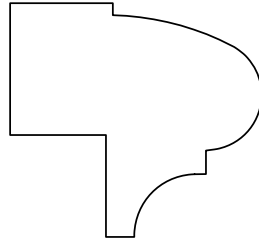

HM594

1 1/4" x 1 5/16"

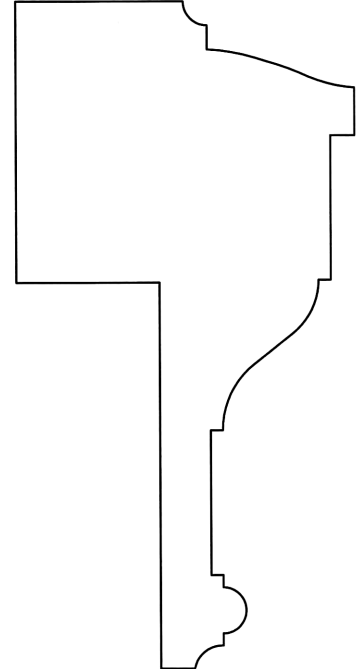

HM597

1 3/4" x 3 7/16"

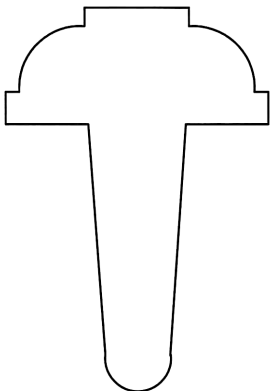

HM595

2" x 1 3/8"

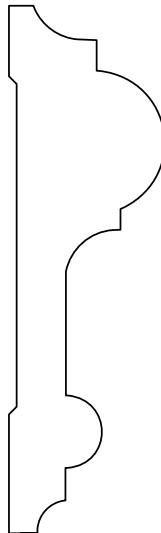

HM596

13/16" x 2 3/4"



HURDER MILLWORK

www.HurderMillwork.com

**CROWN
PROFILES**



HURDER MILLWORK

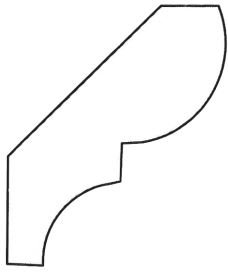

IN-STOCK

HM601

9/16" x 1 3/4"

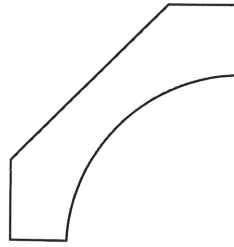

IN-STOCK

HM602

5/8" x 1 3/4"

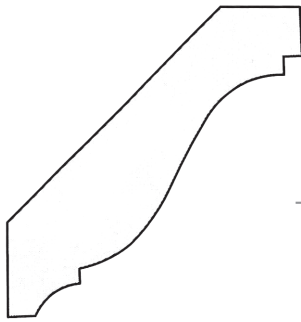

IN-STOCK

HM603

9/16" x 2 1/4"

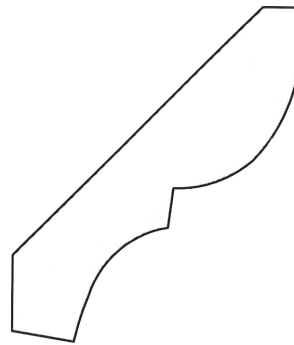

IN-STOCK

HM604

9/16" x 1 3/4"

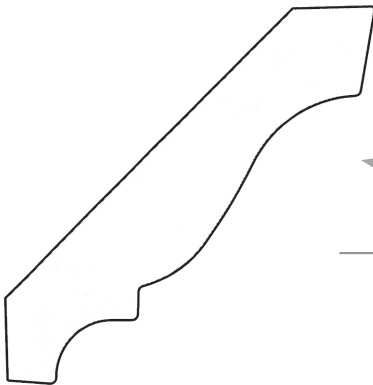

IN-STOCK

HM605

9/16" x 2 3/4"

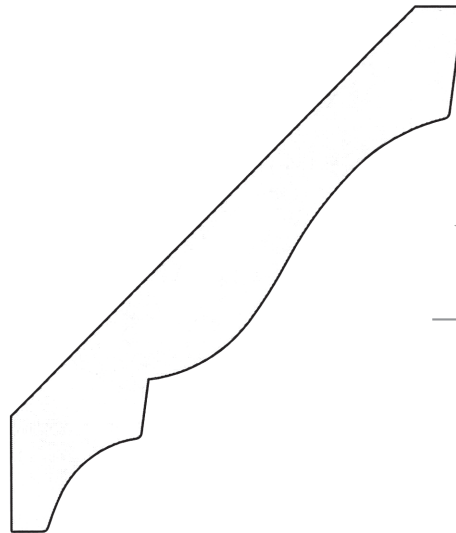

IN-STOCK

HM606

9/16" x 3 5/8"

HURDER MILLWORK

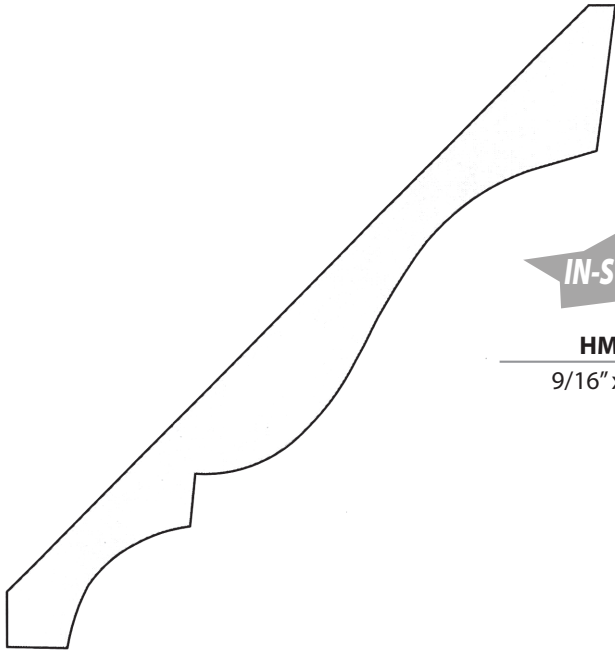

IN-STOCK

HM607

9/16" x 4 5/8"

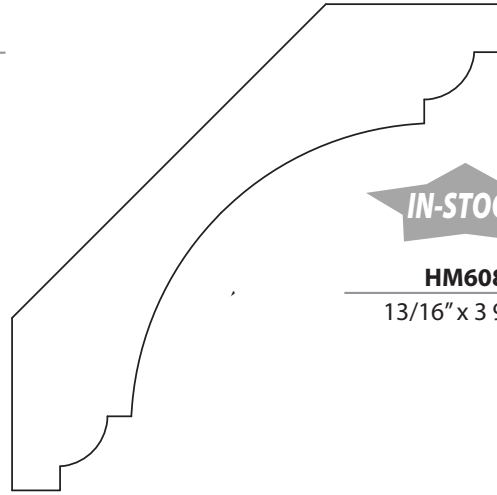

IN-STOCK

HM608

13/16" x 3 9/16"

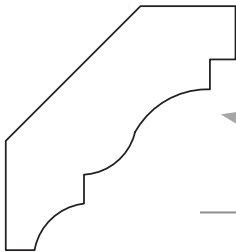

IN-STOCK

HM609

9/16" x 1 3/4"

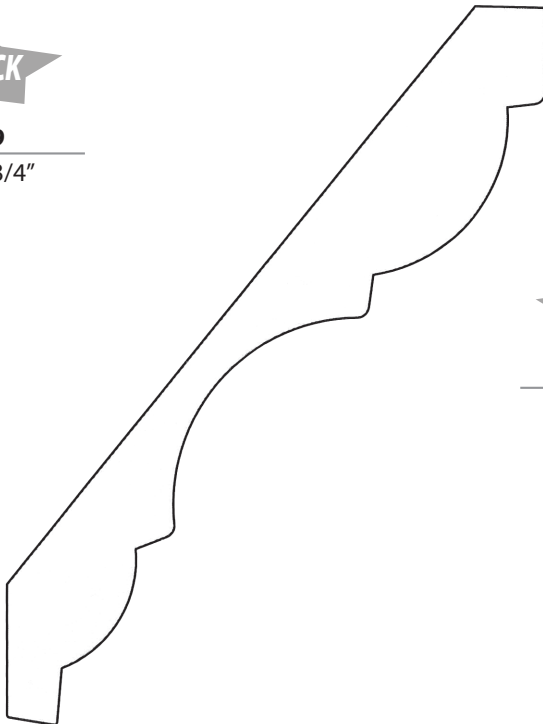

IN-STOCK

HM611

11/16" x 4 5/8"

HURDER MILLWORK

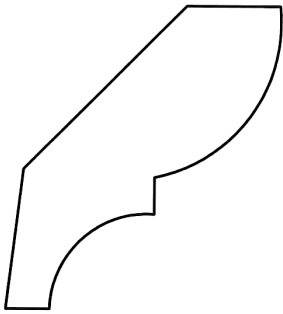

HM620
9/16" x 1 3/4"

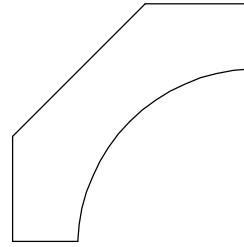

HM621
5/8" x 1 3/4"

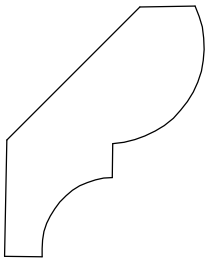

HM622
9/16" x 1 5/8"

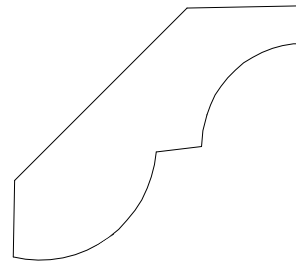

HM623
9/16" x 2"

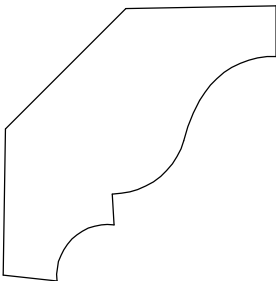

HM624
3/4" x 2"

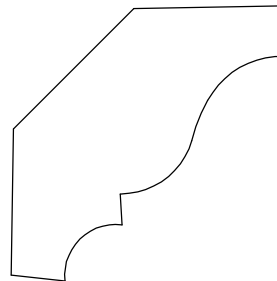

HM625
7/8" x 2 1/8"

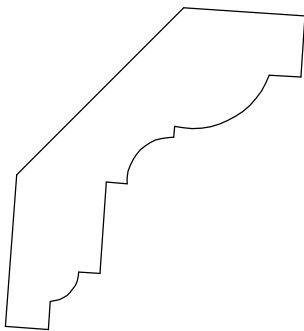

HM626
1 1/16" x 2 1/4"

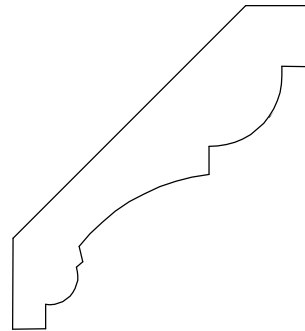

HM627
1/2" x 2 5/16"

HURDER MILLWORK

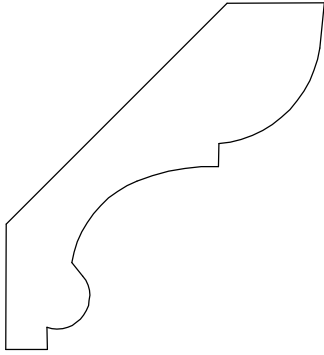

HM628
5/8" x 2 7/16"

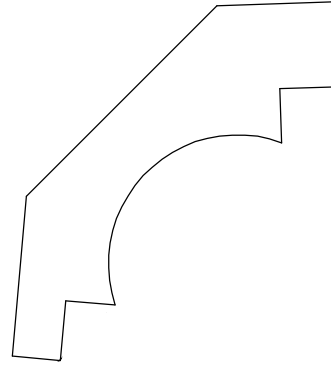

HM629
3/4" x 2 1/2"

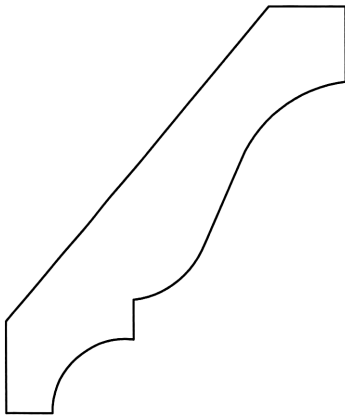

HM630
9/16" x 2 3/4"

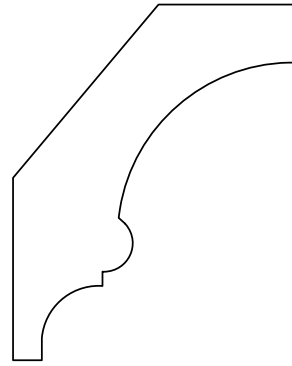

HM631
3/4" x 2 3/8"

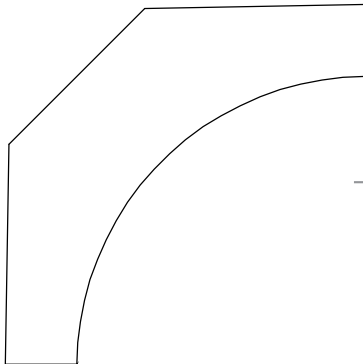

HM632
1 1/16" x 2 21/32"

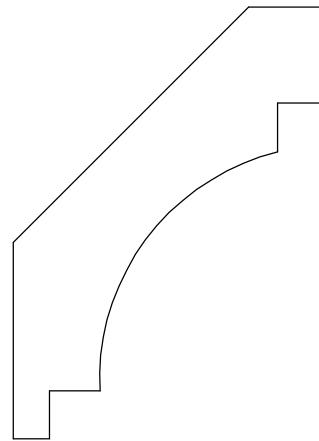

HM633
7/8" x 2 3/4"

HURDER MILLWORK

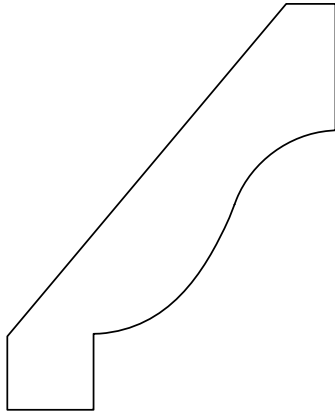

HM634
9/16" x 2 3/4"

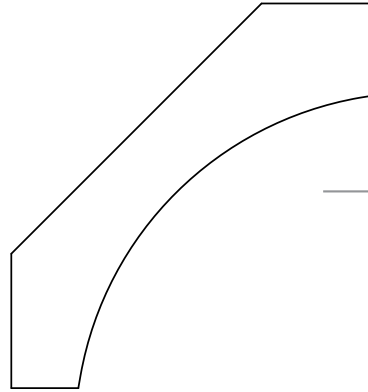

HM635
3/4" x 2 3/4"

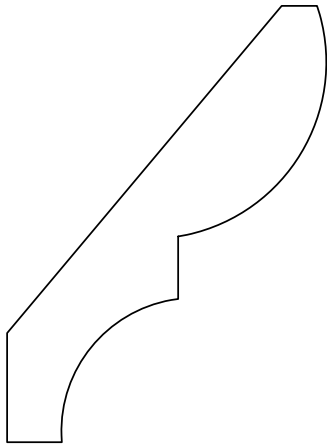

HM636
9/16" x 2 3/4"

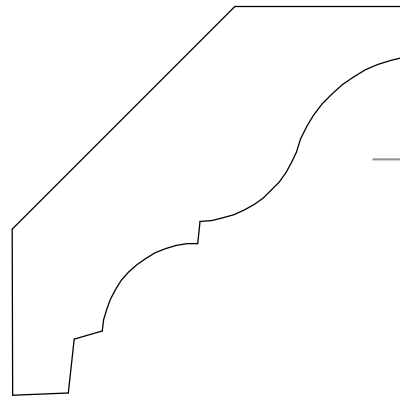

HM637
13/16" x 2 7/8"

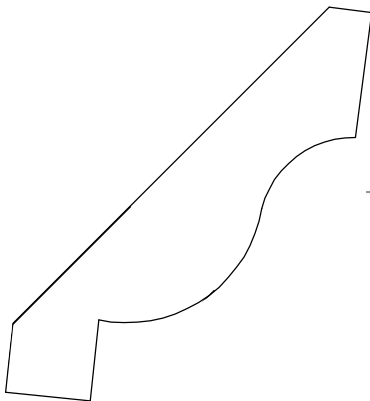

HM638
5/8" x 2 3/4"

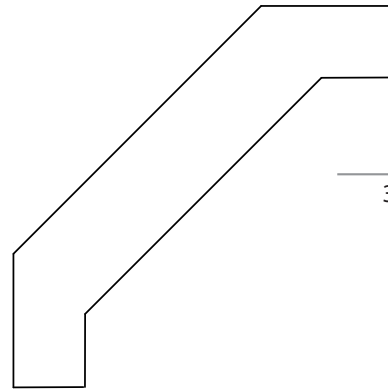

HM639
3/4" x 2 13/16"

HURDER MILLWORK

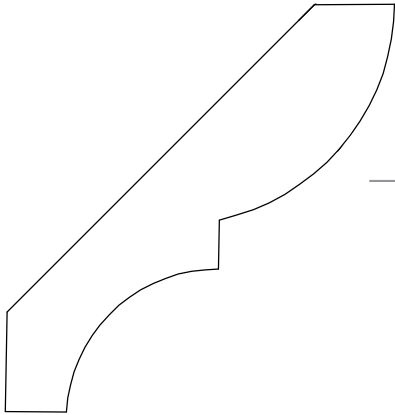

HM640
5/8" x 2 15/16"

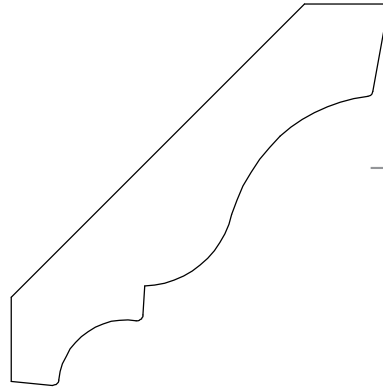

HM641
37/64" x 2 25/32"

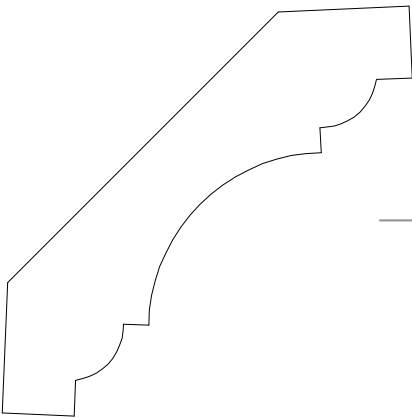

HM642
3/4" x 3"

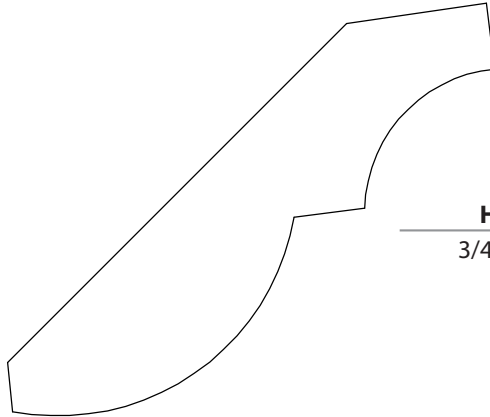

HM643
3/4" x 3 1/4"

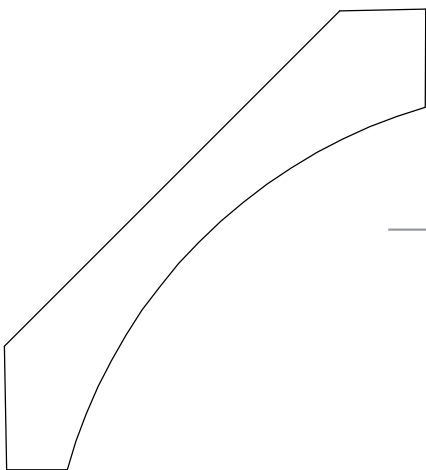

HM644
11/16" x 3 1/4"

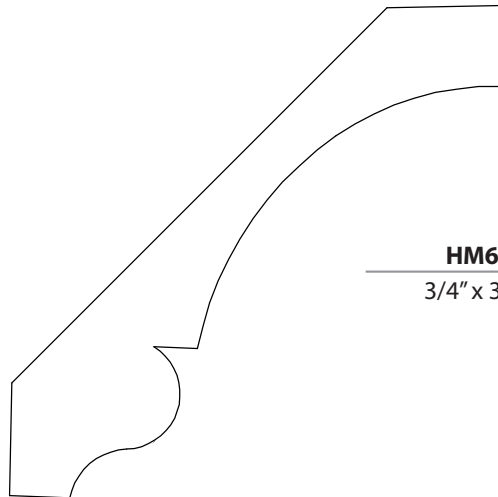

HM645
3/4" x 3 5/8"

HURDER MILLWORK

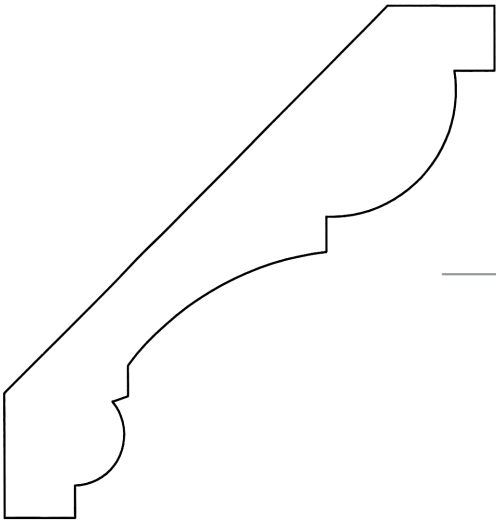

HM646
3/4" x 3 3/4"

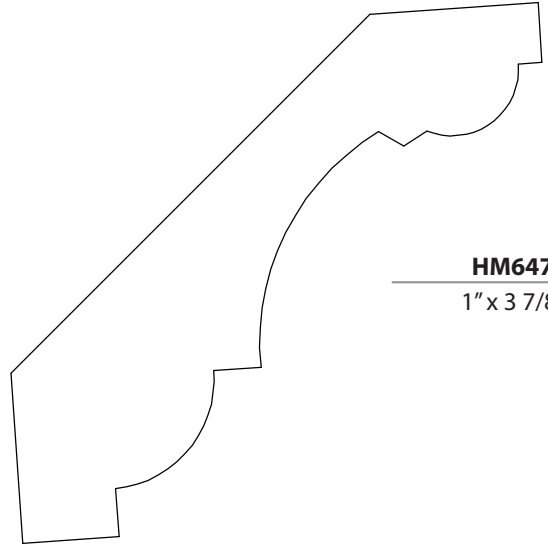

HM647
1" x 3 7/8"

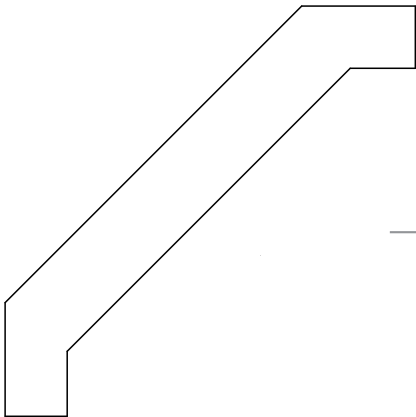

HM648
3/4" x 3 31/2"

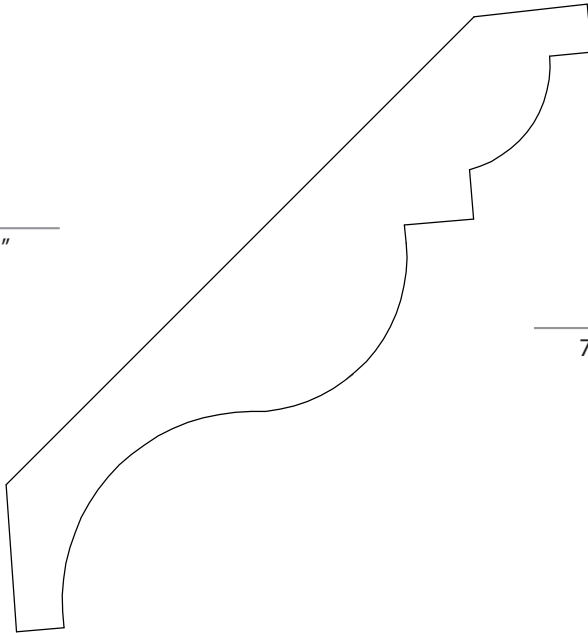

HM649
7/8" x 4 13/16"

HURDER MILLWORK

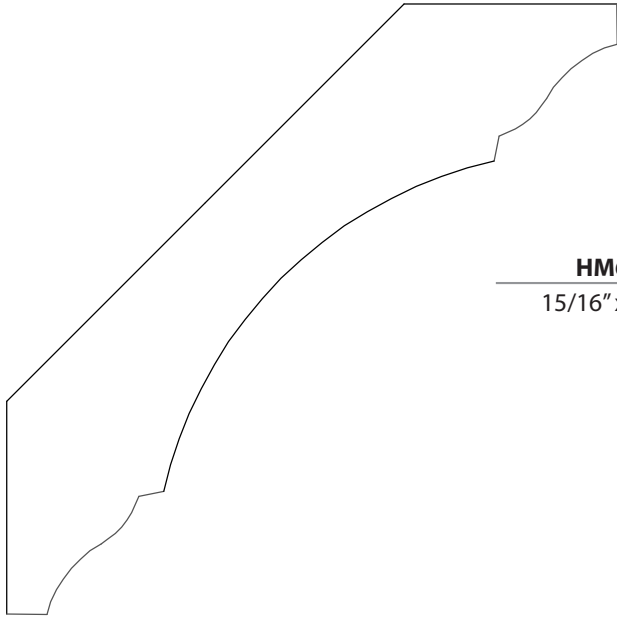

HM650
15/16" x 4 1/2"

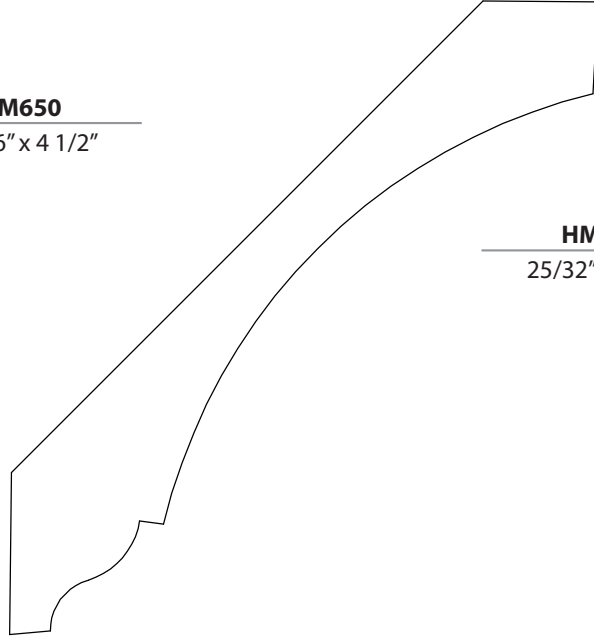

HM651
25/32" x 4 1/2"

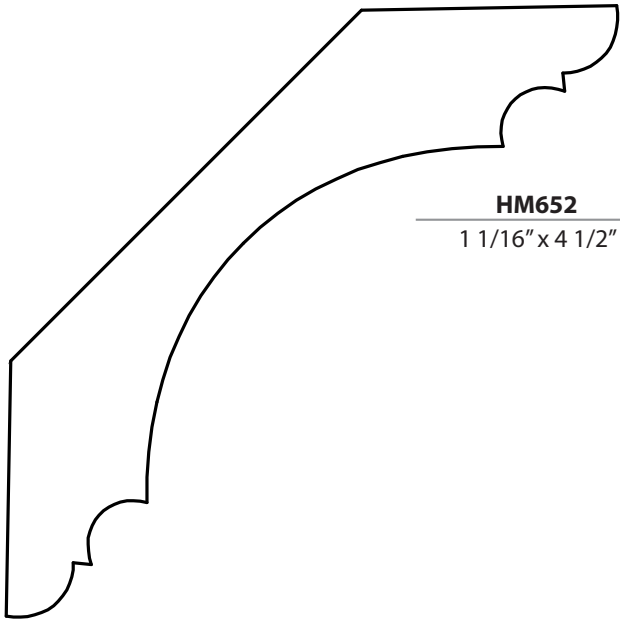

HM652
1 1/16" x 4 1/2"

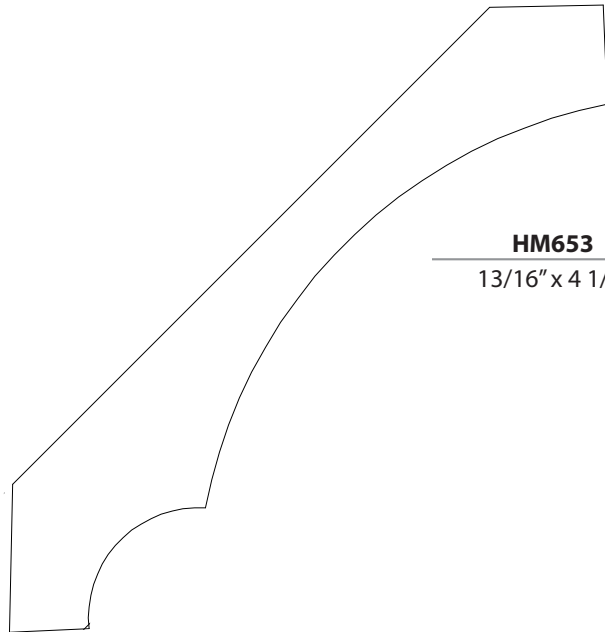

HM653
13/16" x 4 1/2"

HURDER MILLWORK

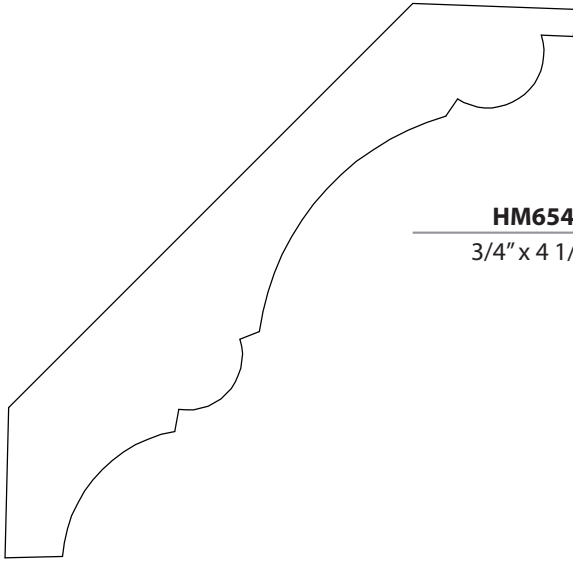

HM654

3/4" x 4 1/8"

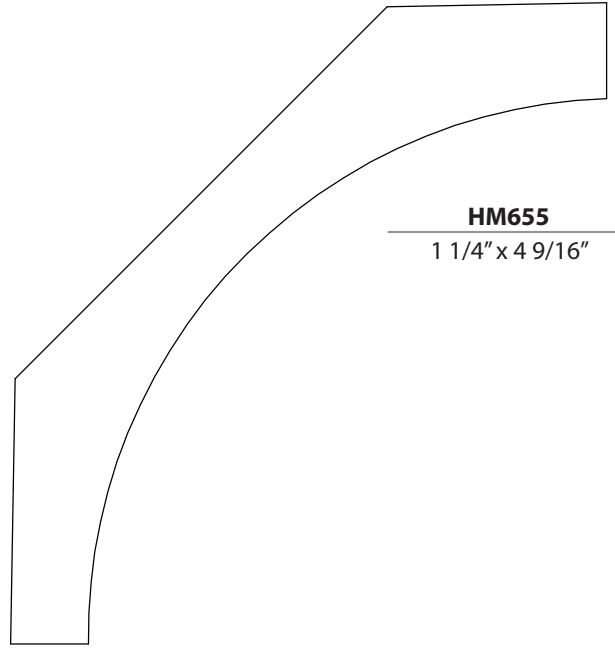

HM655

1 1/4" x 4 9/16"

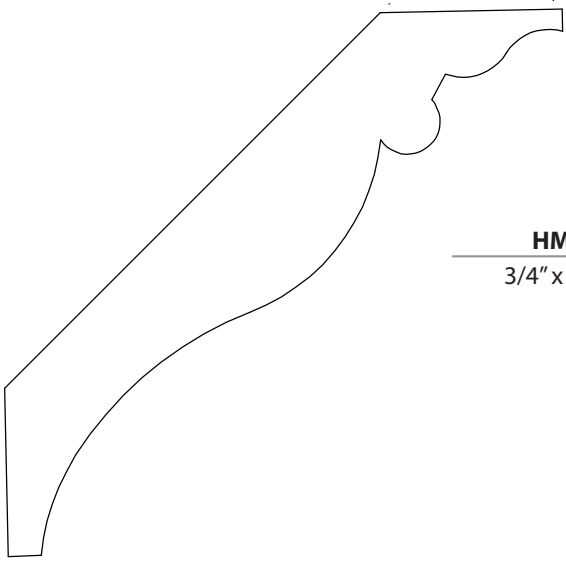

HM656

3/4" x 4 1/16"

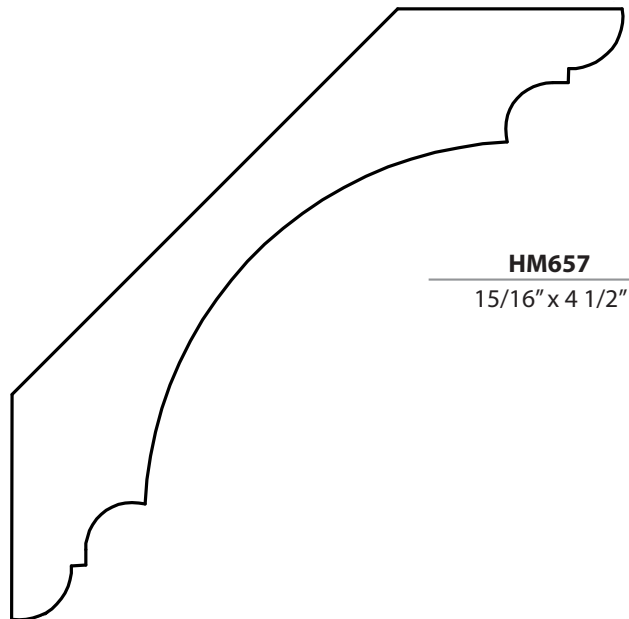

HM657

15/16" x 4 1/2"

HURDER MILLWORK

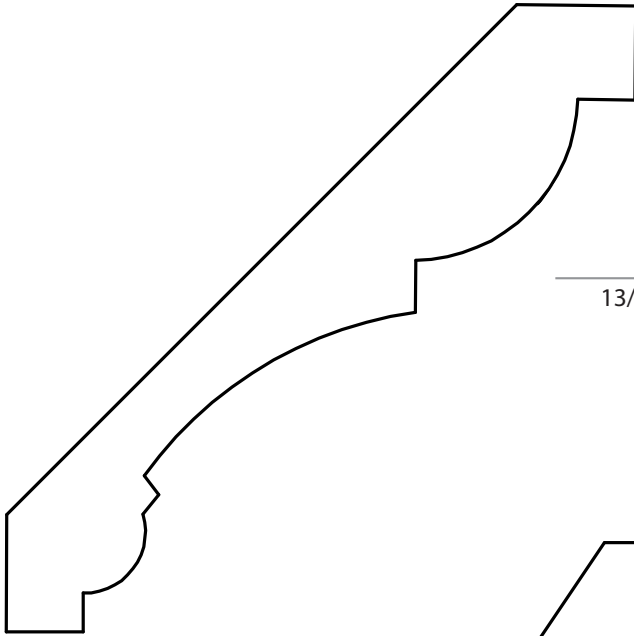

HM658

13/16" x 4 5/8"

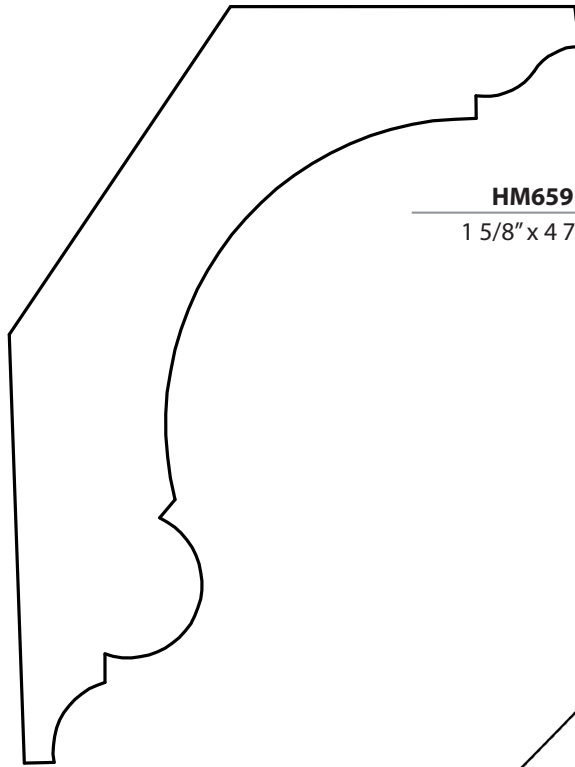

HM659

1 5/8" x 4 7/8"

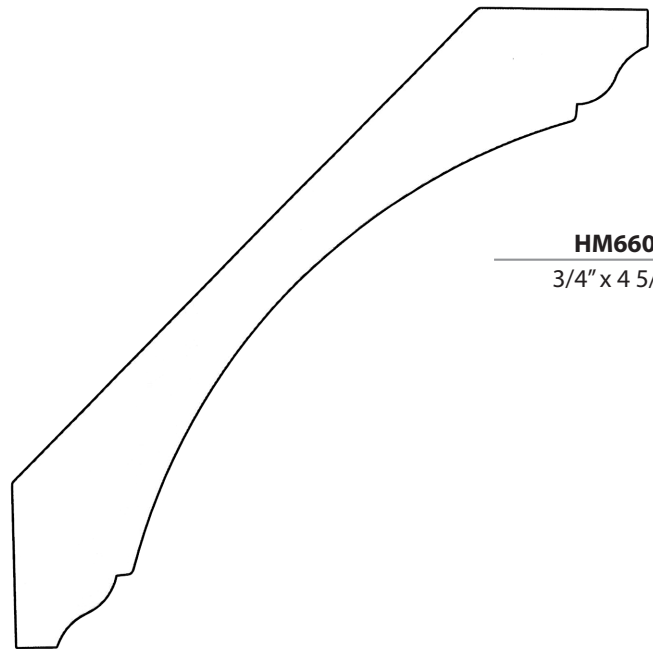

HM660

3/4" x 4 5/8"

HURDER MILLWORK

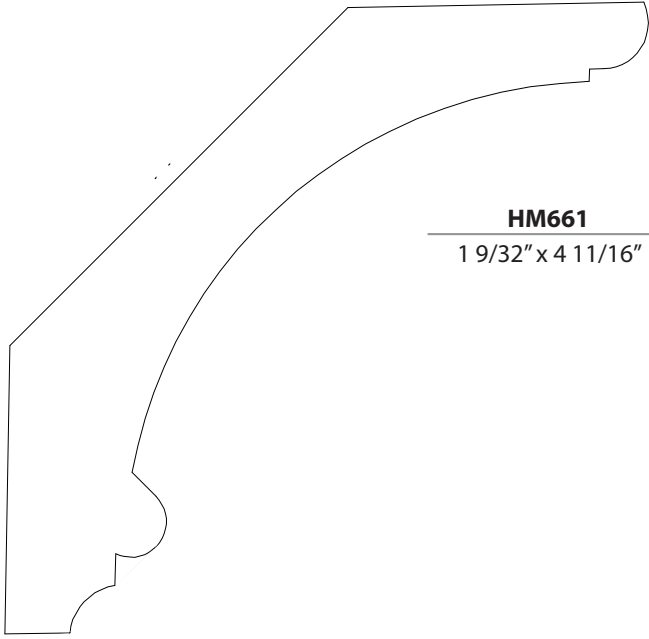

HM661
1 9/32" x 4 11/16"

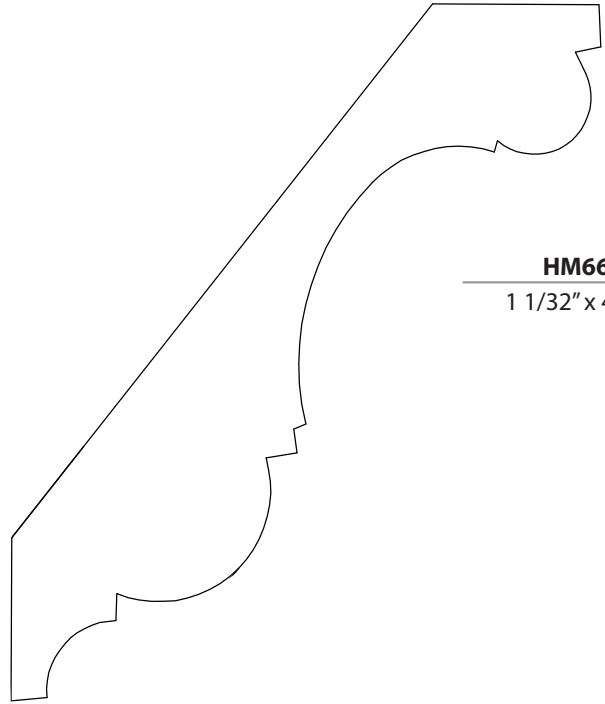

HM662
1 1/32" x 4 3/4"

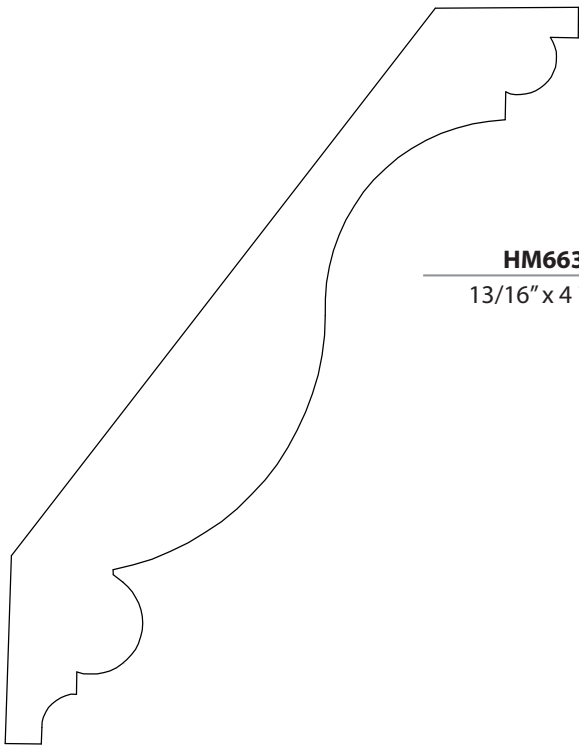

HM663
13/16" x 4 7/8"

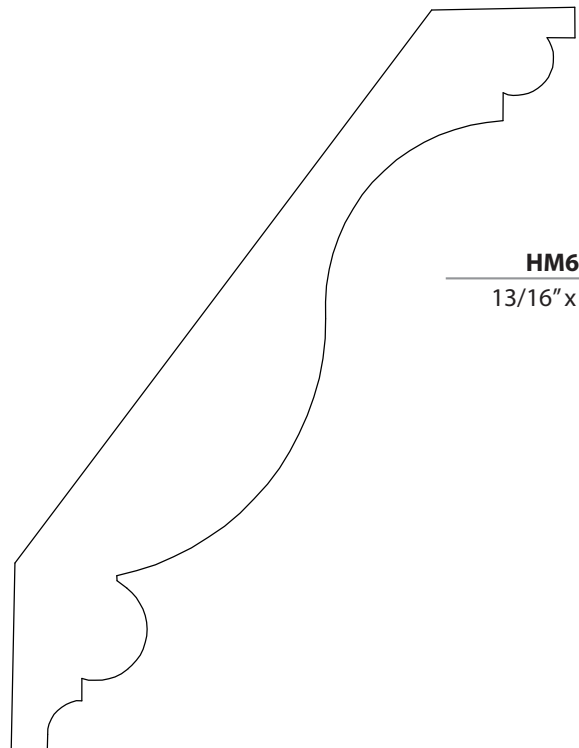

HM663
13/16" x 4 7/8"

HURDER MILLWORK

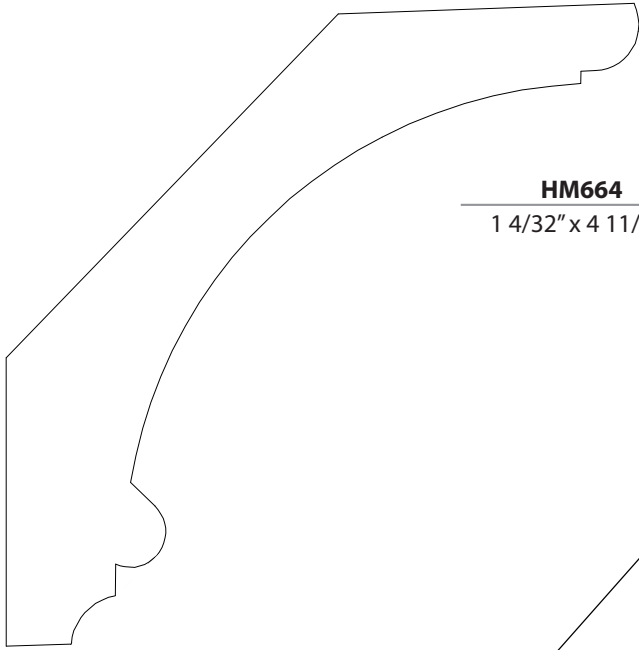

HM664
1 4/32" x 4 11/16"

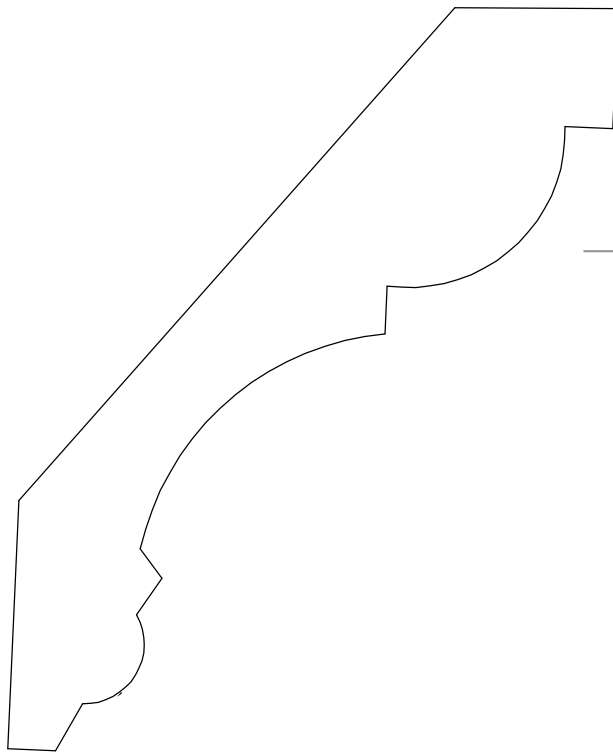

HM665
1 1/16" x 5"

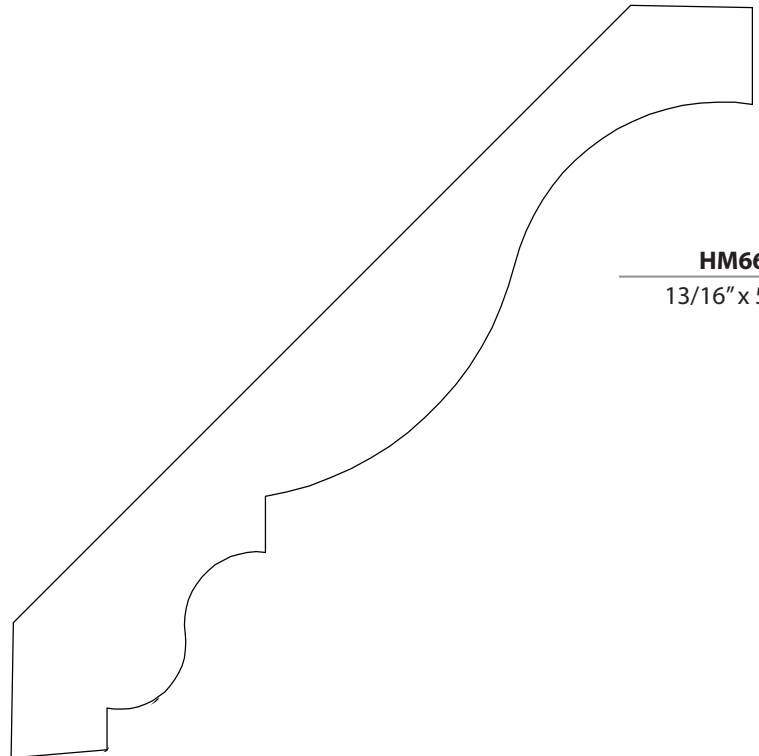

HM666
13/16" x 5 1/2"

HURDER MILLWORK

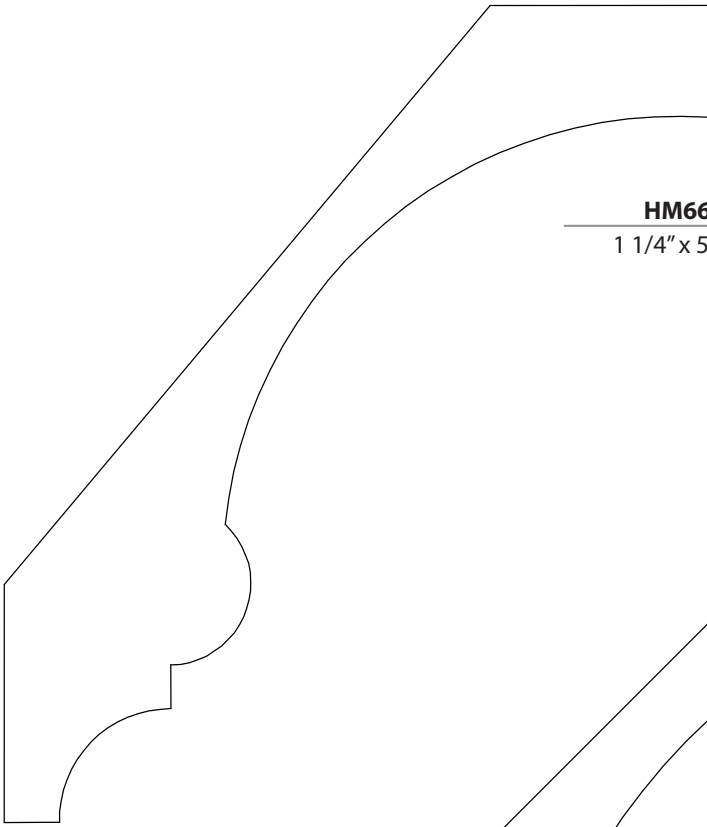

HM667

1 1/4" x 5 5/8"

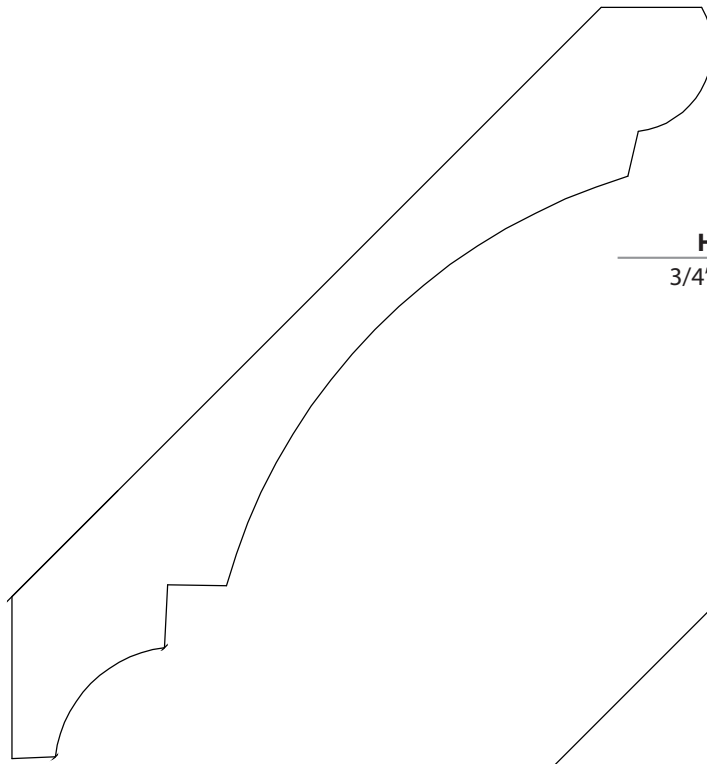

HM668

3/4" x 5 5/16"

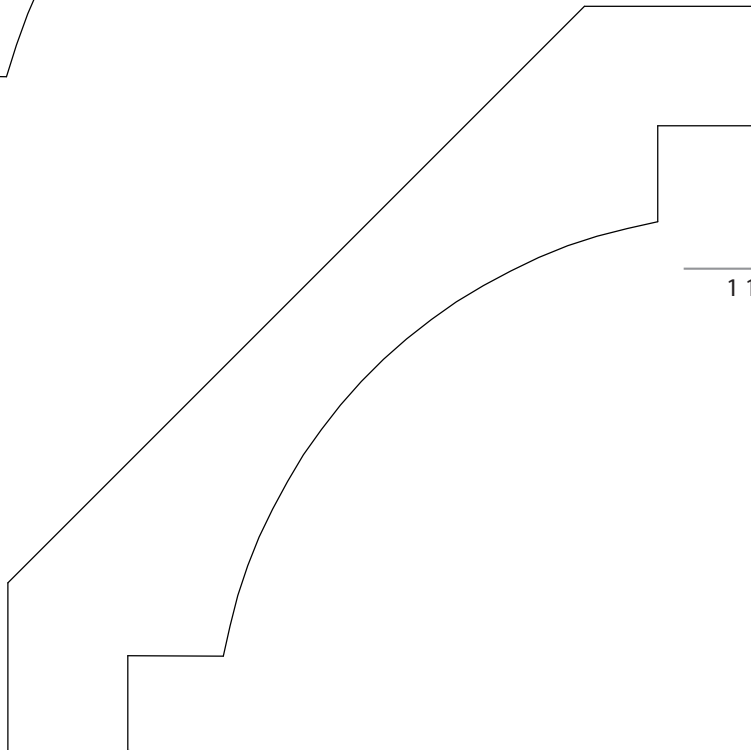

HM669

1 1/16" x 5 1/2"

HURDER MILLWORK

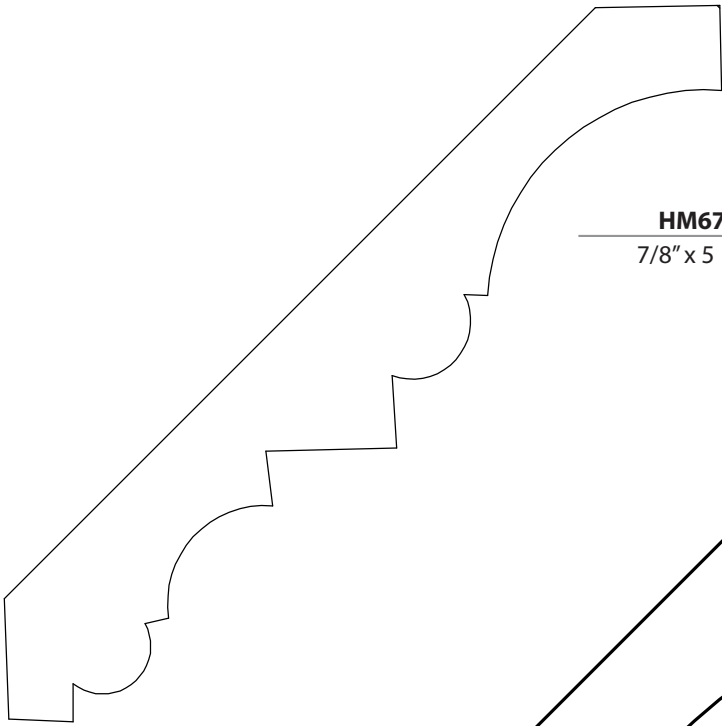

HM670
7/8" x 5 1/4"

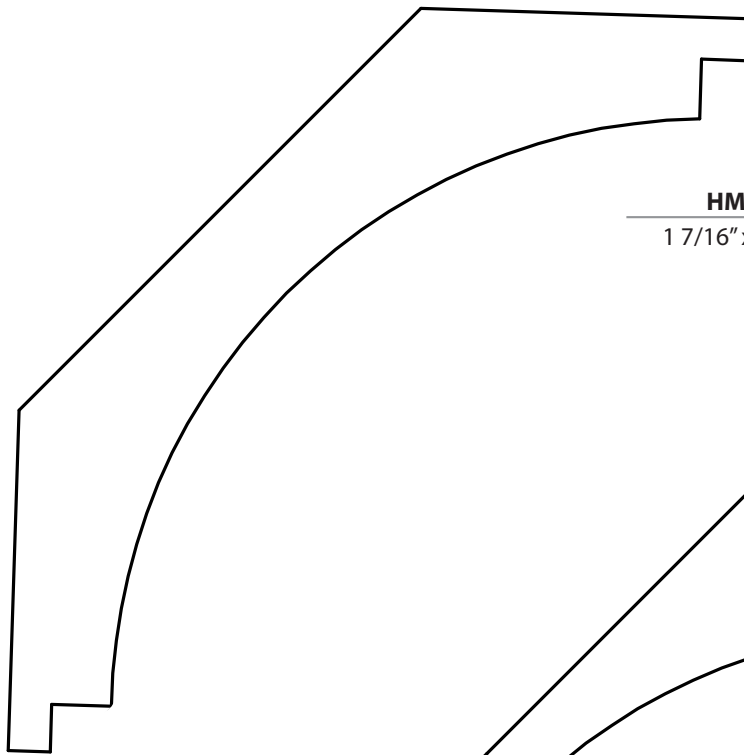

HM671
1 7/16" x 5 7/16"

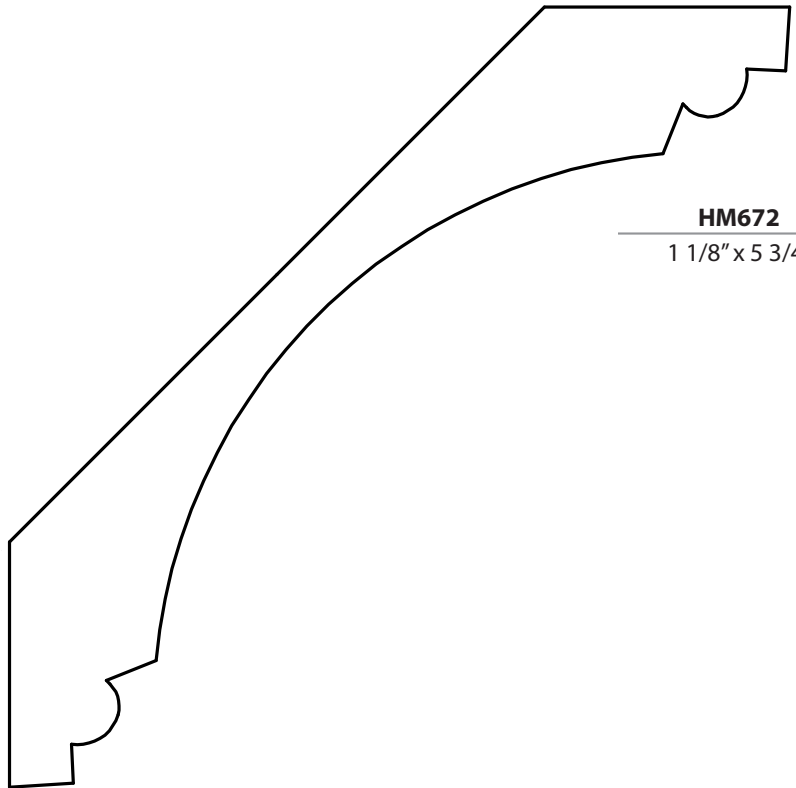

HM672
1 1/8" x 5 3/4"

HURDER MILLWORK

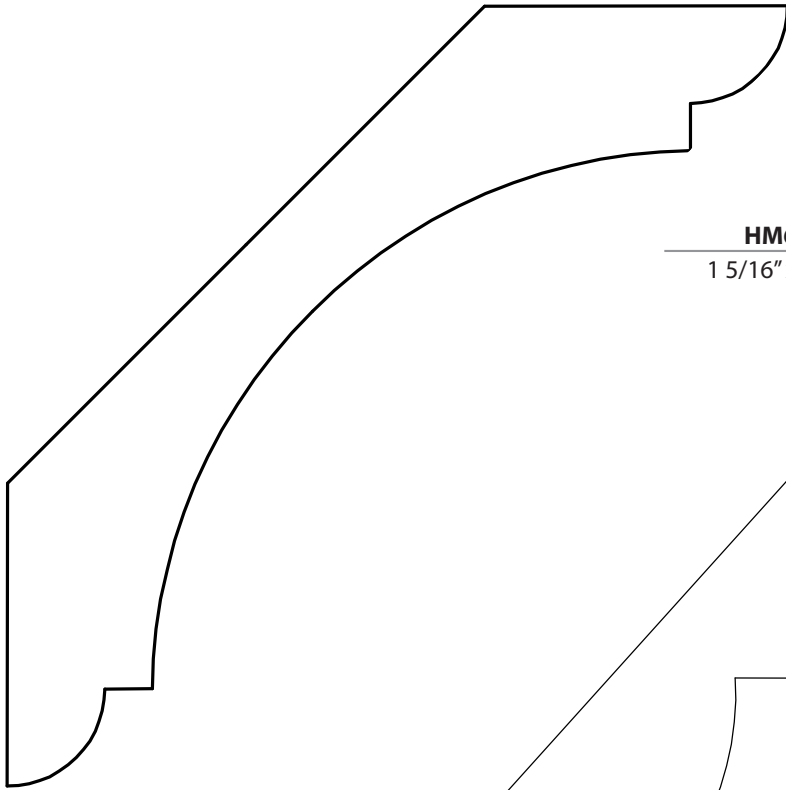

HM673
1 5/16" x 5 3/4"

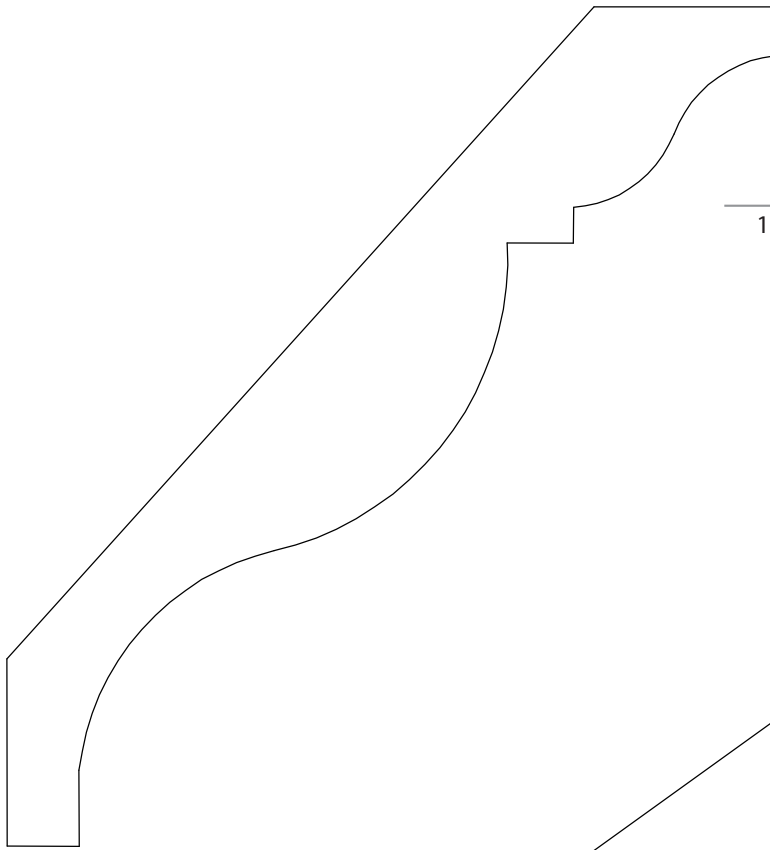

HM674
15/16" x 5 15/16"



HM675
3/4" x 6"



HURDER MILLWORK

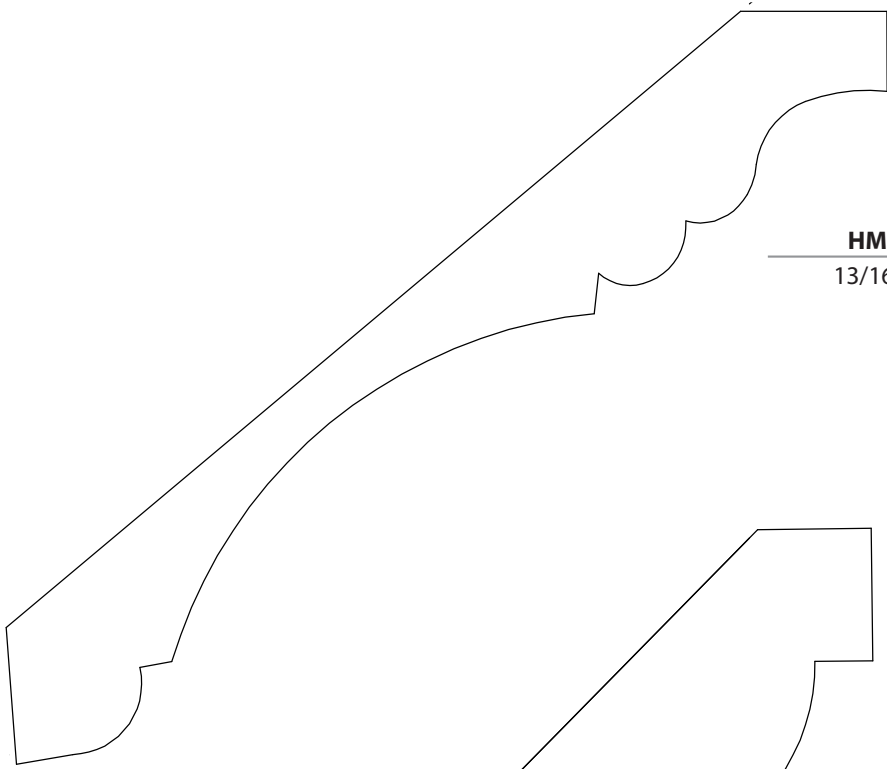

HM676
13/16" x 6"

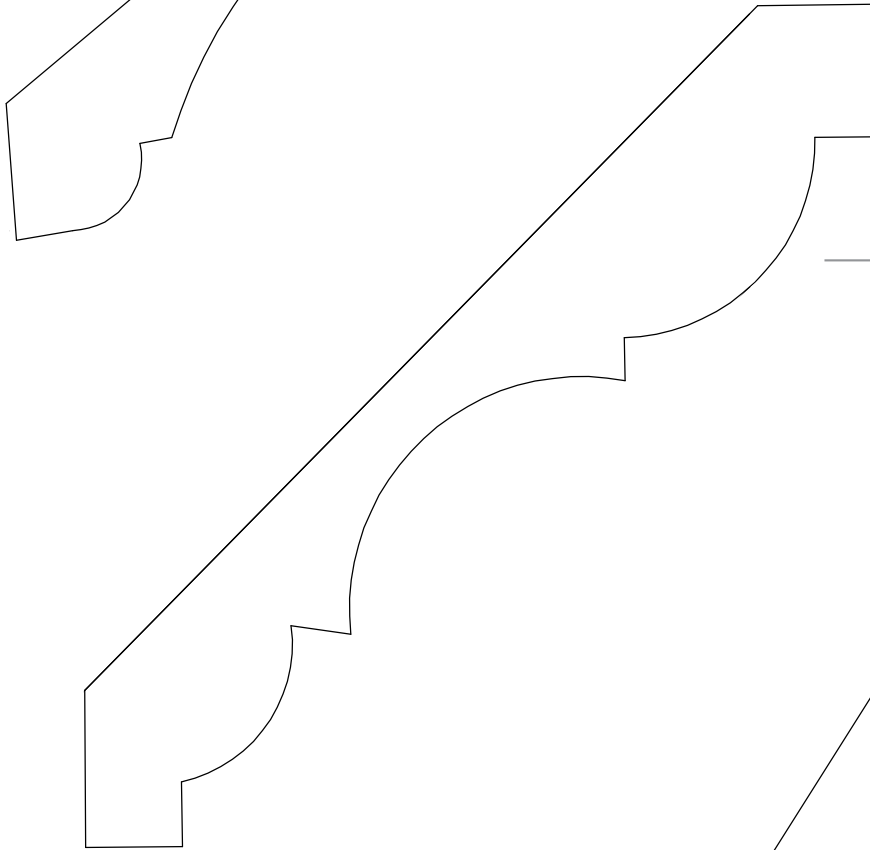

HM677
1" x 6"

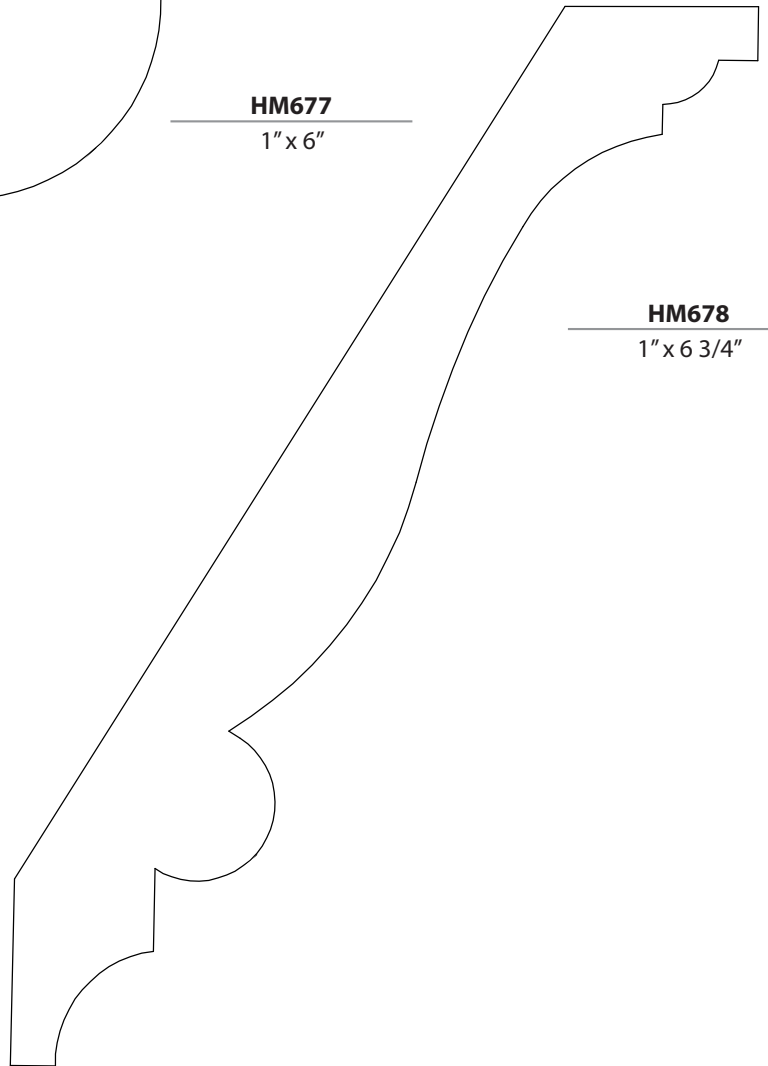

HM678
1" x 6 3/4"

**HURDER
MILLWORK**

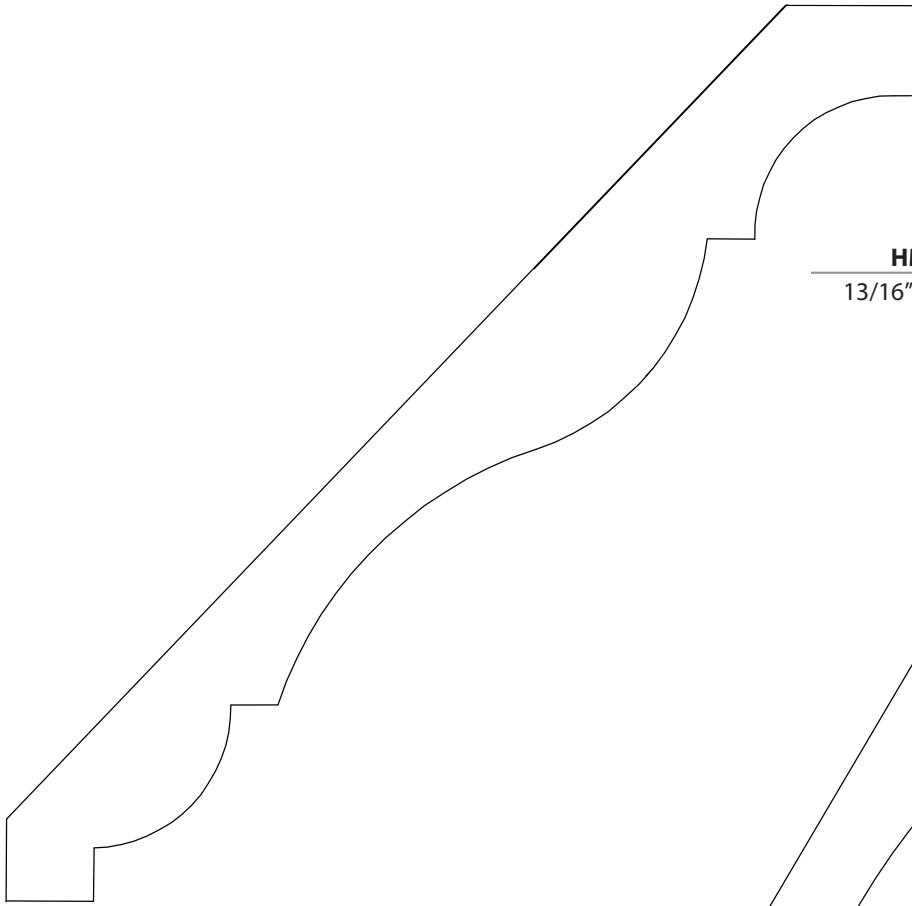

HM679
13/16" x 6 21/32"

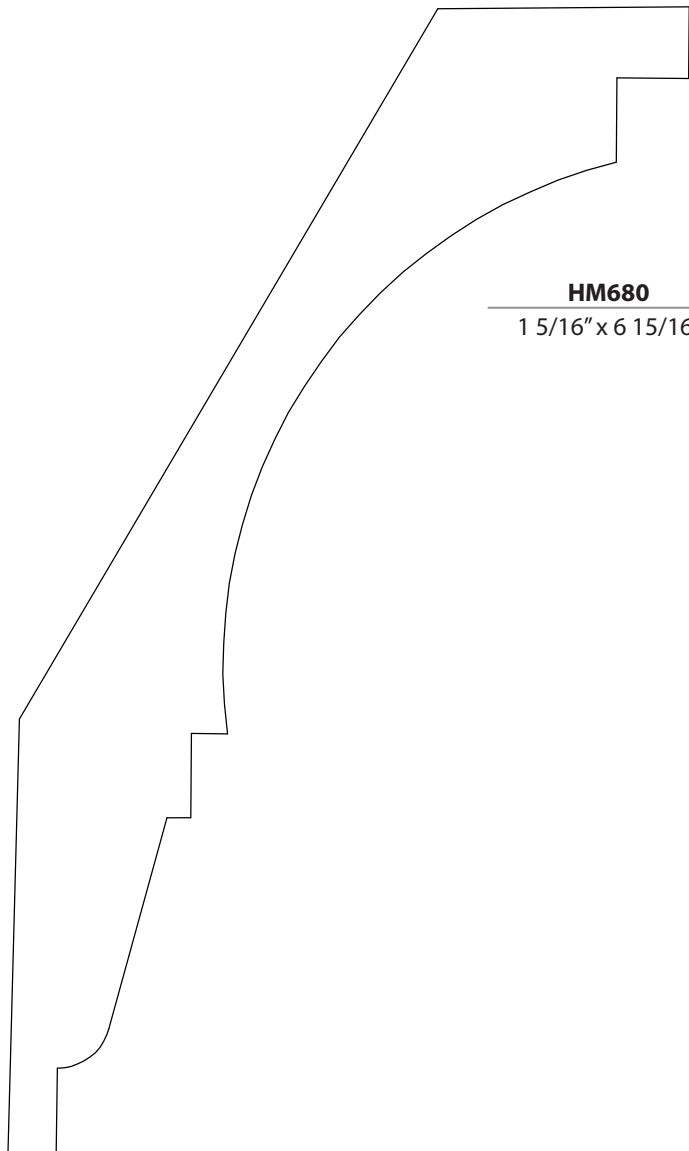

HM680
1 5/16" x 6 15/16"

HURDER MILLWORK



HM681
3/4" x 6 1/2"

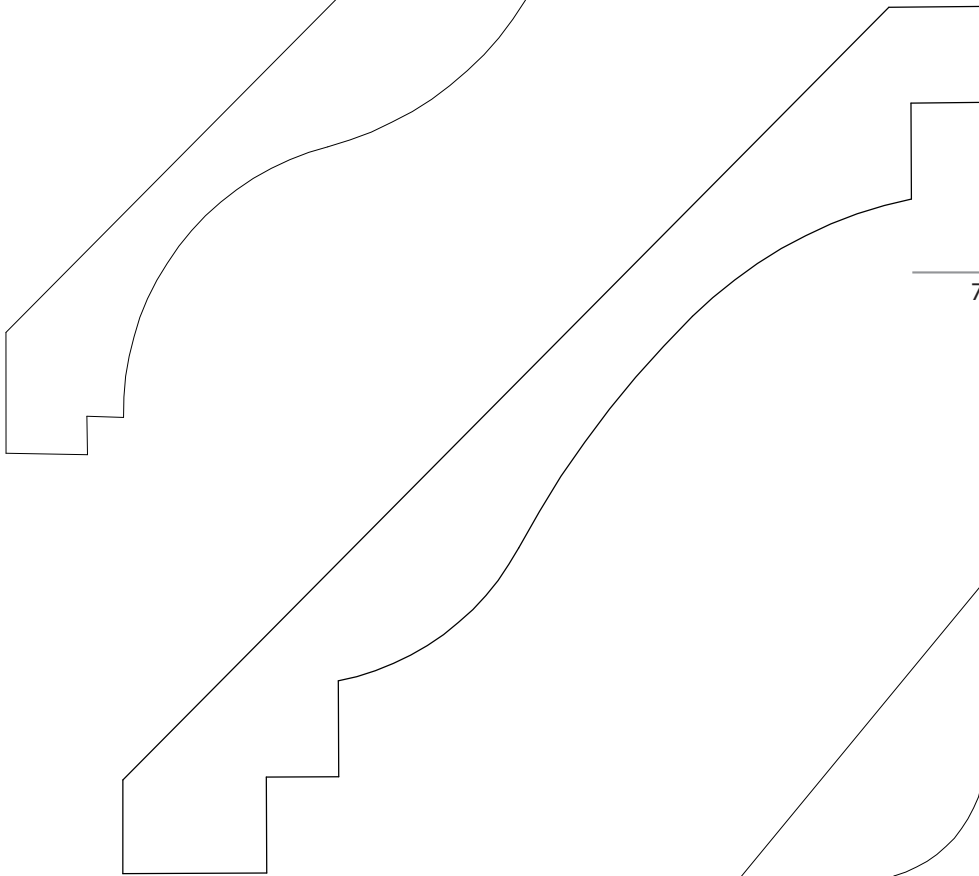

HM682
7/8" x 6 3/8"

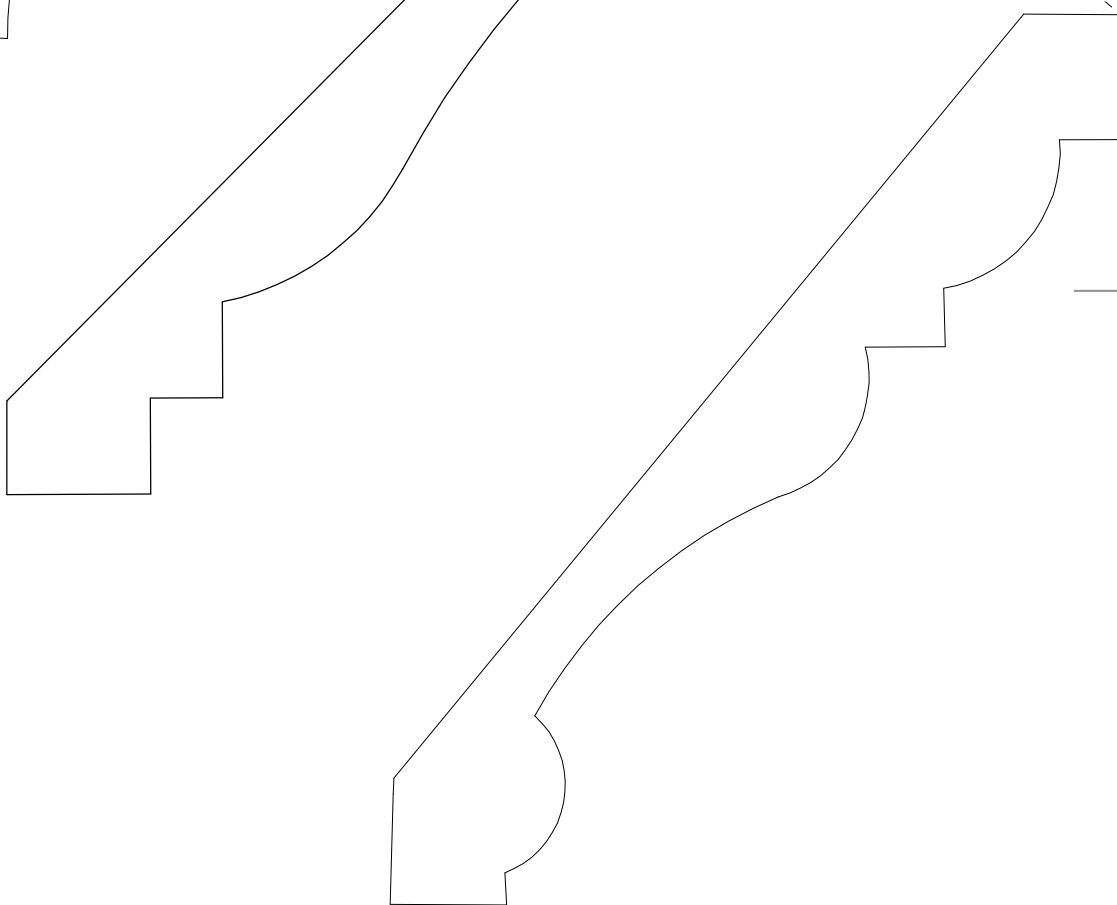

HM683
7/8" x 6"

HURDER MILLWORK

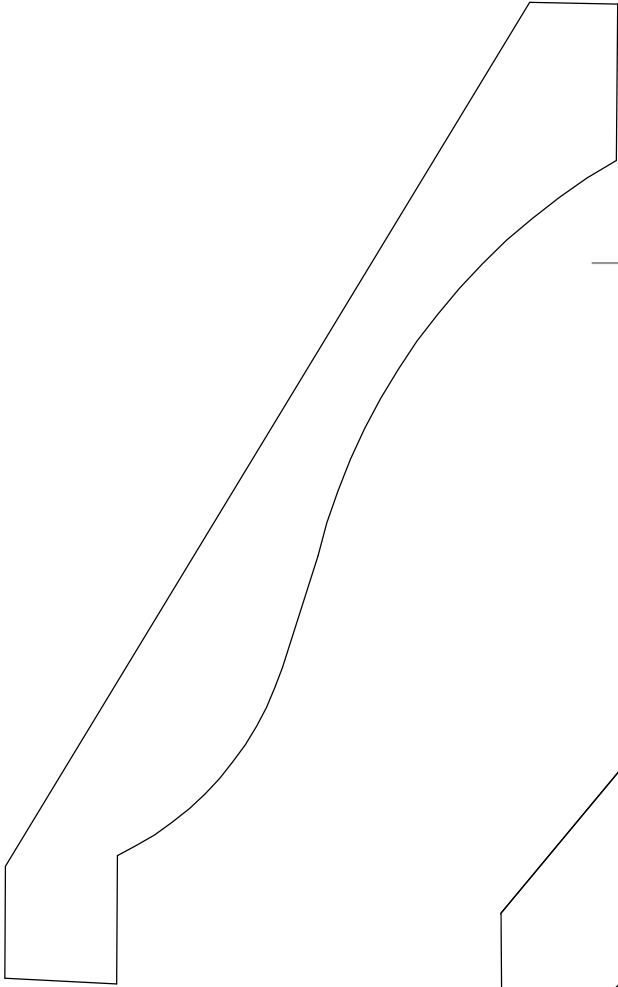

HM684
1 3/16" x 6"

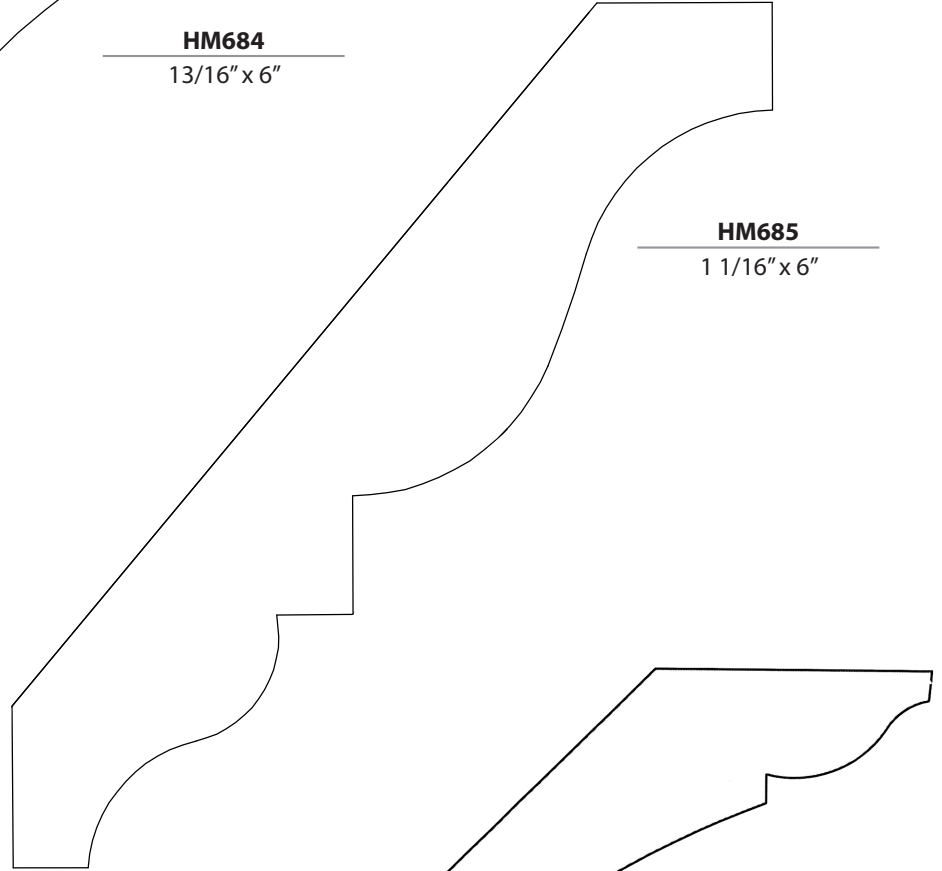

HM685
1 1/16" x 6"

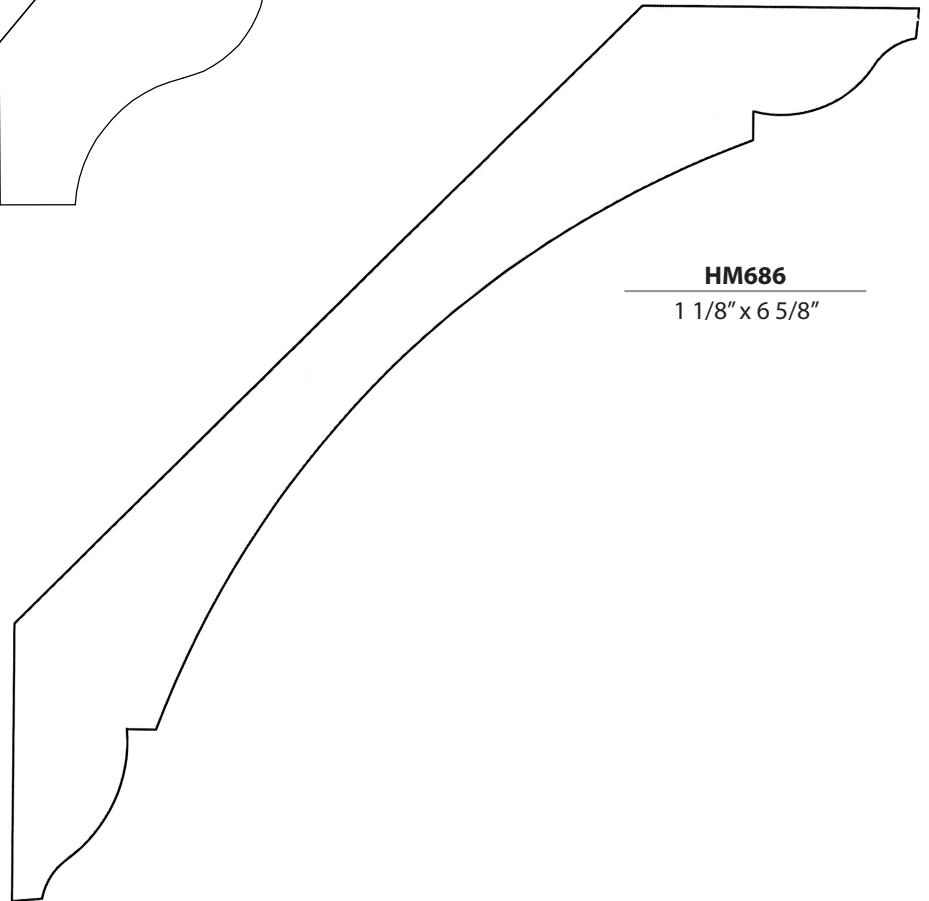

HM686
1 1/8" x 6 5/8"

HURDER MILLWORK

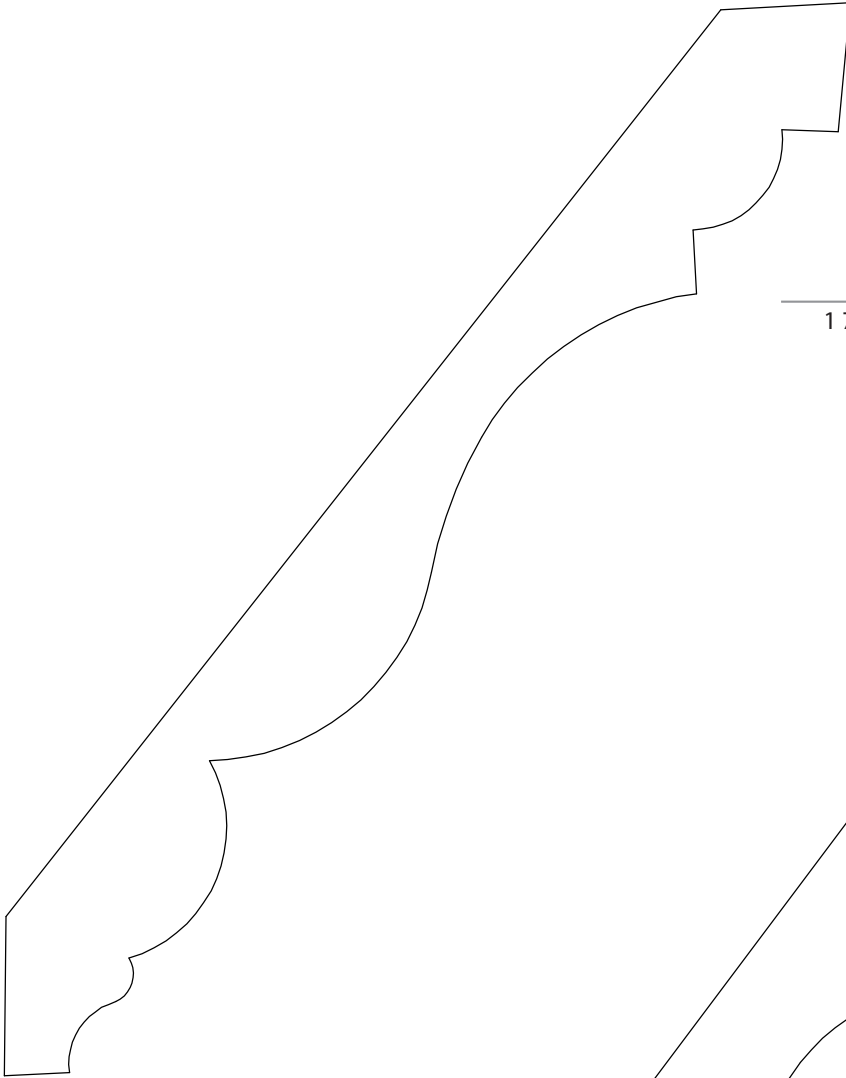

HM687

1 7/16" x 7 1/8"

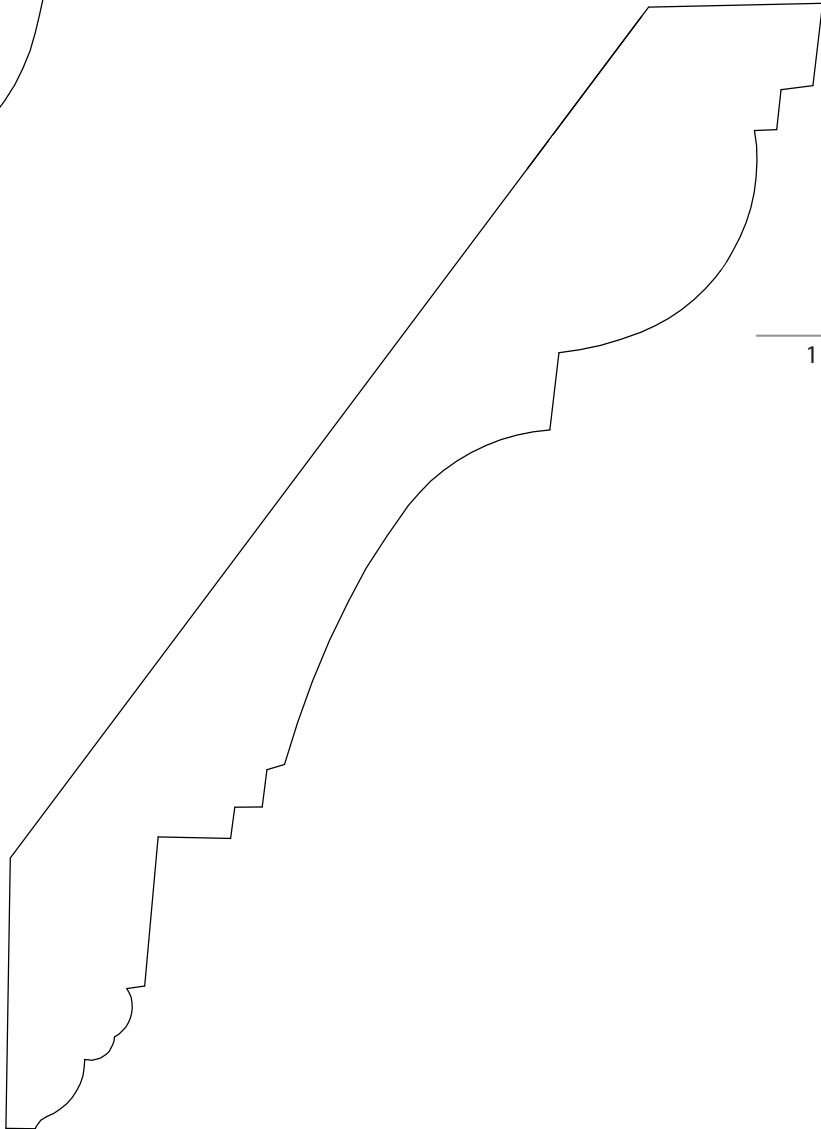

HM688

1 1/8" x 7 1/4"

**HURDER
MILLWORK**

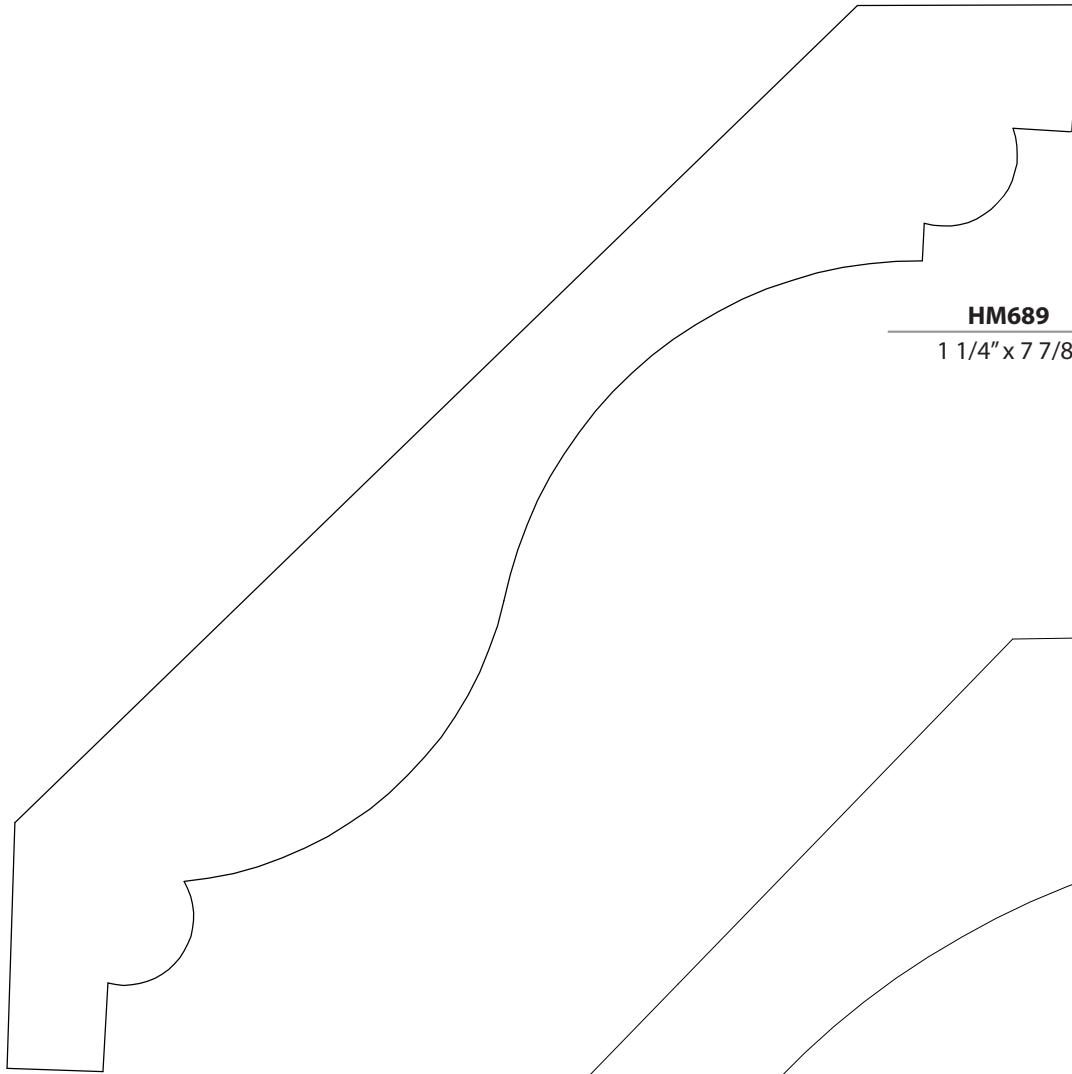

HM689
1 1/4" x 7 7/8"

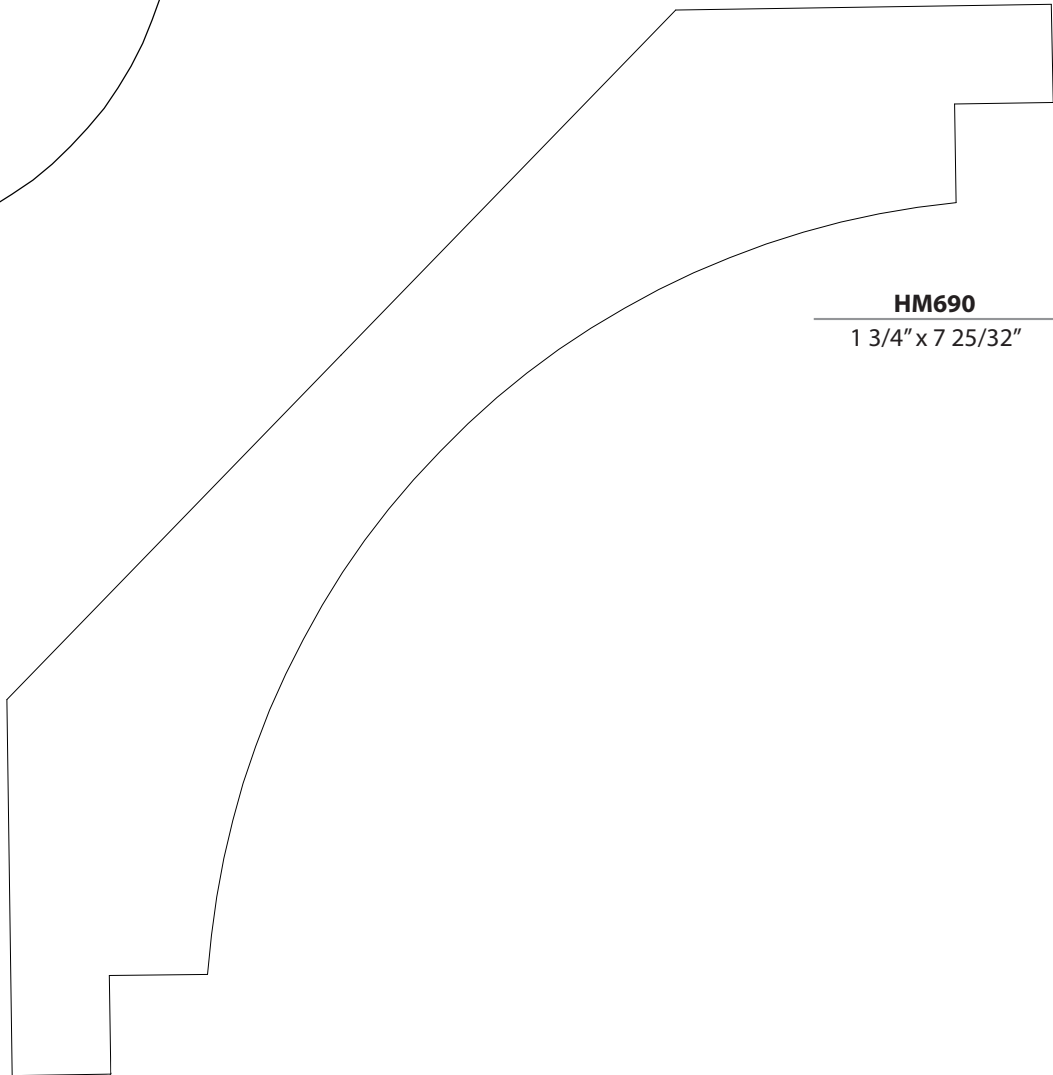

HM690
1 3/4" x 7 25/32"



**HURDER
MILLWORK**

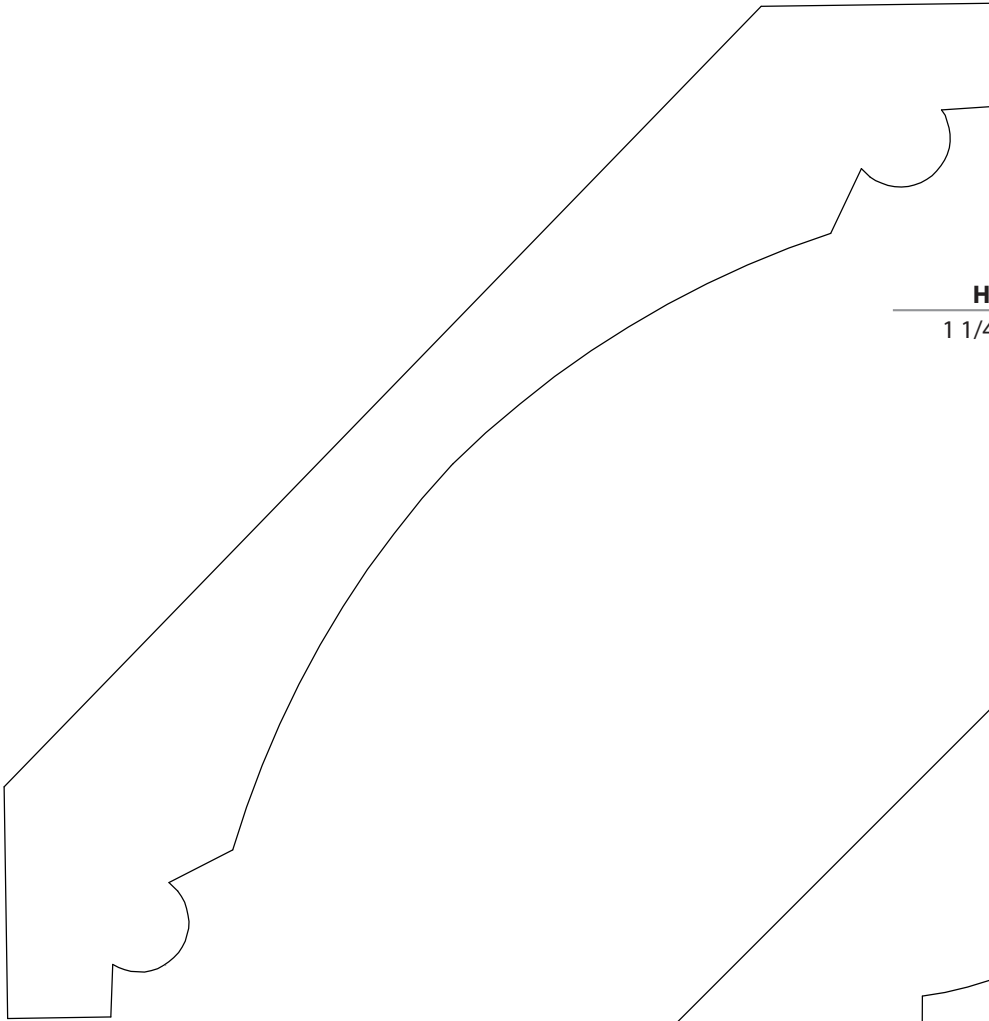

HM691

1 1/4" x 7 3/8"



HM692

1 1/4" x 7 3/8"

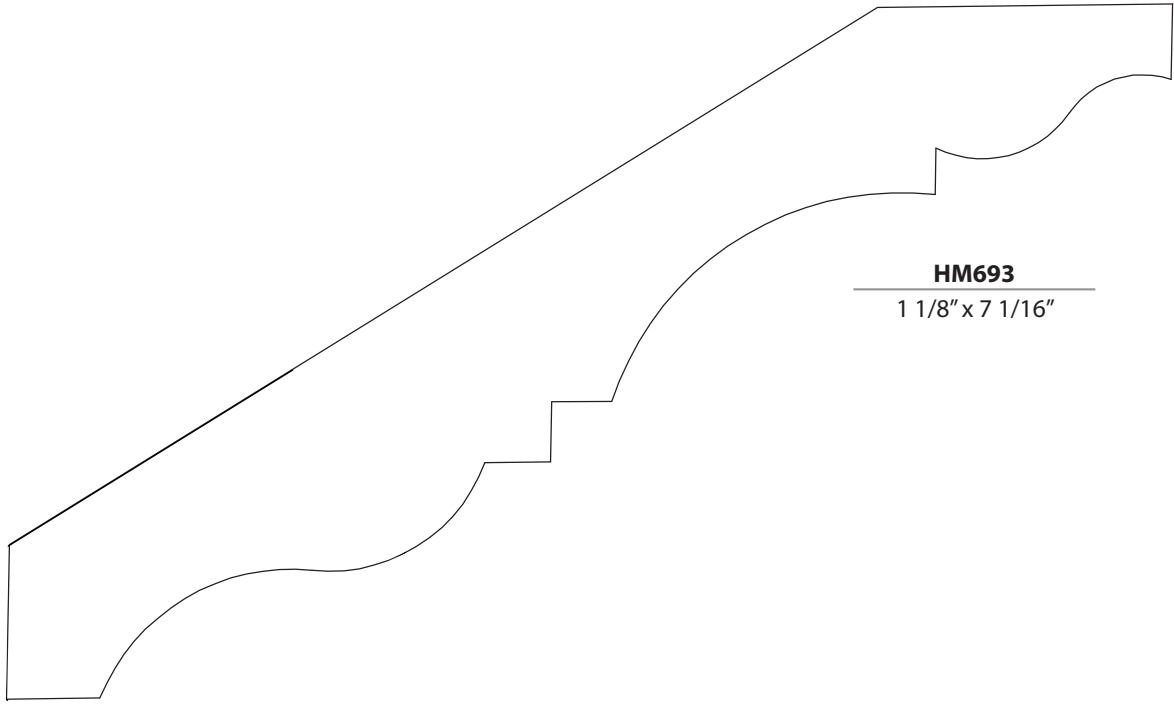

HM693

1 1/8" x 7 1/16"



HURDER MILLWORK

www.HurderMillwork.com

BASE BOARDS PROFILES



HURDER MILLWORK

IN-STOCK



Ogee
HM700

9/16" x 3 1/2"

IN-STOCK

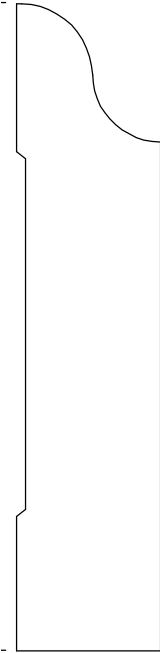

HM701

3/4" x 3 3/8"

IN-STOCK



HM702

9/16" x 3 1/4"

IN-STOCK

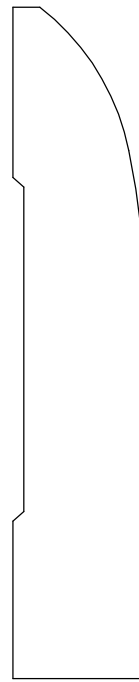

HM703

11/16" x 3 1/2"

IN-STOCK

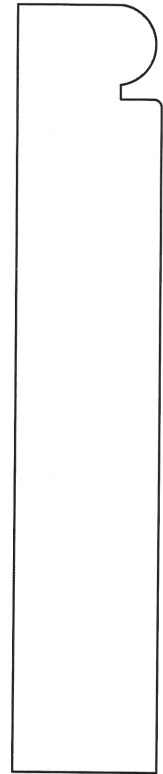

Beaded
HM704

3/4" x 3 1/2"

HURDER MILLWORK

IN-STOCK



HM705
9/16" x 4 1/4"

IN-STOCK

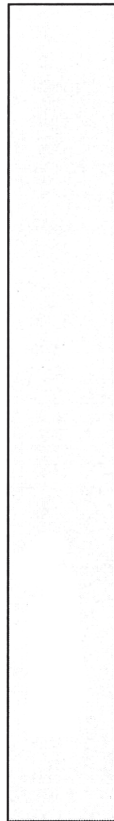

HM706
9/16" x 4 1/4"

IN-STOCK

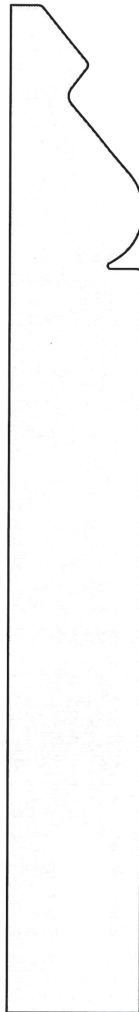

HM707
11/16" x 5 1/4"

IN-STOCK

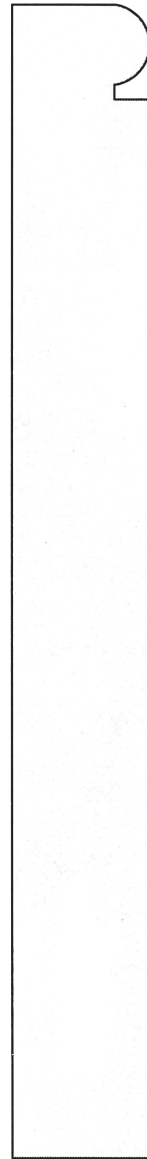

HM708
3/4" x 5 1/2"

IN-STOCK

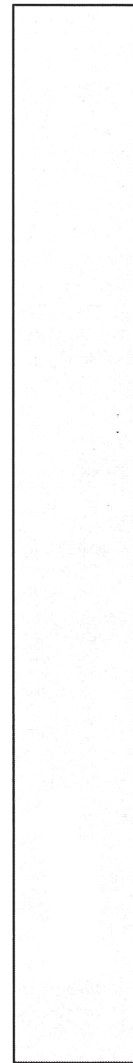

HM709
5/8" x 5 1/2"

HURDER MILLWORK

IN-STOCK



Speed Base

HM711

11/16" x 7 3/4"

IN-STOCK

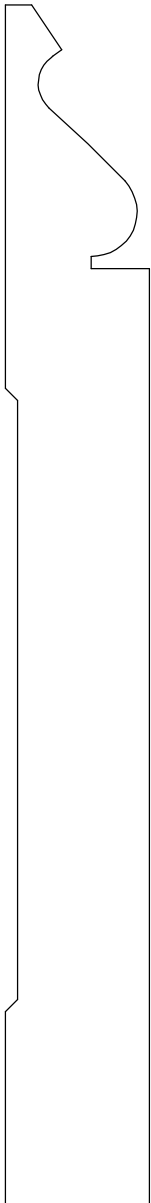

HM710

3/4" x 6 1/4"



HM712

11/16" x 3 1/2"



HM713

3/4" x 3 1/2"

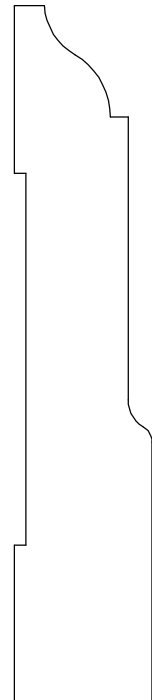

HM714

23/32" x 3 5/8"

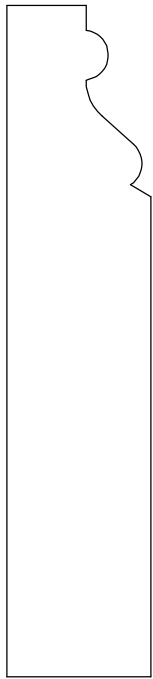

HM715
3/4" x 3 1/2"

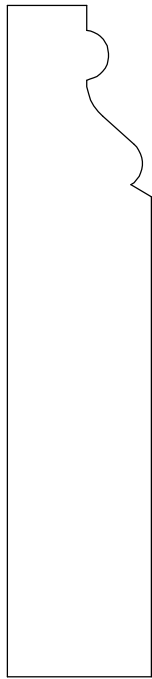

HM716
9/16" x 3 1/4"

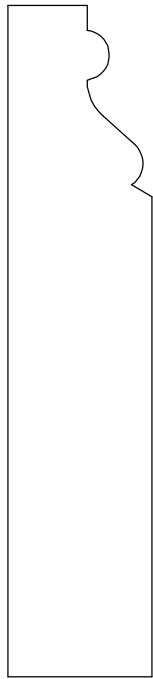

HM717
21/32" x 3 13/16"

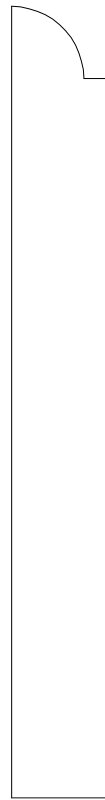

HM718
1/2" x 4 1/8"



HM719
5/8" x 4 1/16"

**HURDER
MILLWORK**

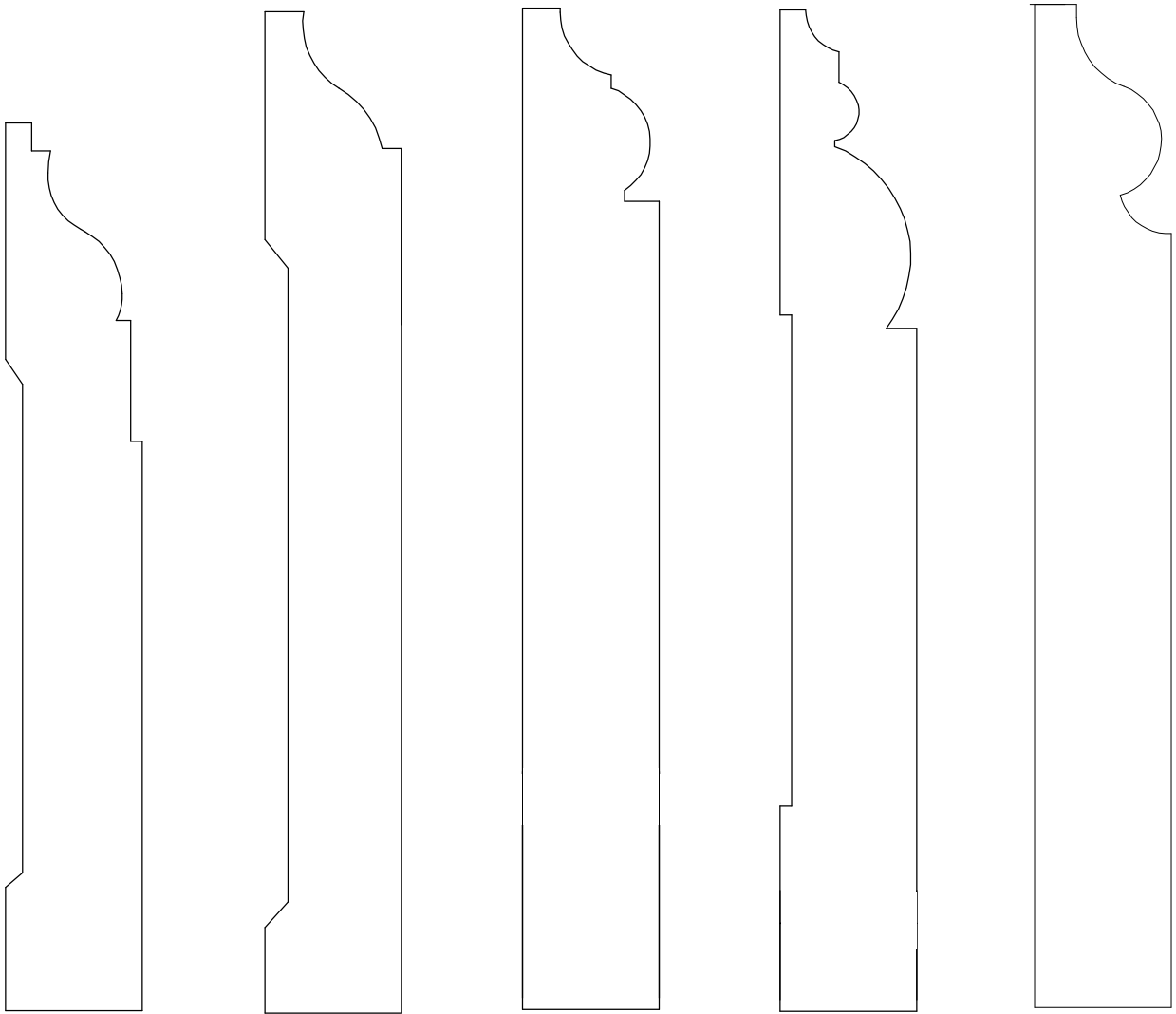

HM720

3/4" x 4 7/8"

HM721

3/4" x 5 1/2"

HM722

3/4" x 5 1/2"

HM723

3/4" x 5 1/2"

HM724

3/4" x 5 1/2"

HURDER MILLWORK



HM725
3/4" x 5 3/4"

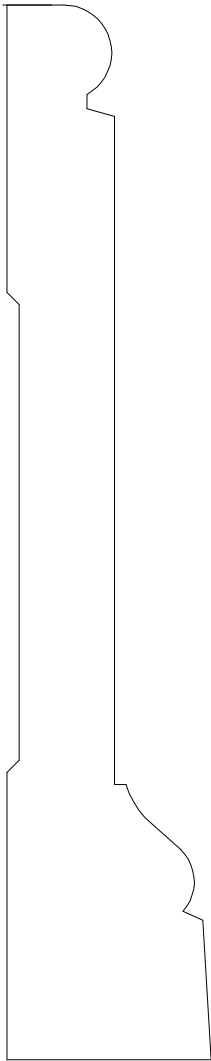

HM726
1 1/16" x 5 1/2"

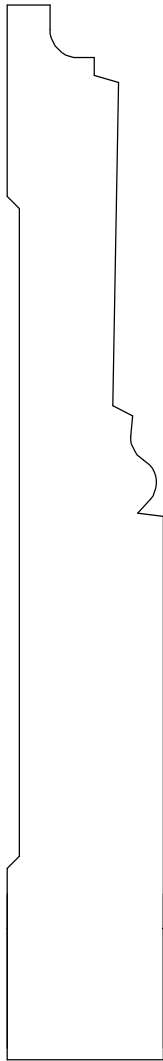

HM727
13/16" x 5 1/2"



HM728
3/4" x 5 1/2"

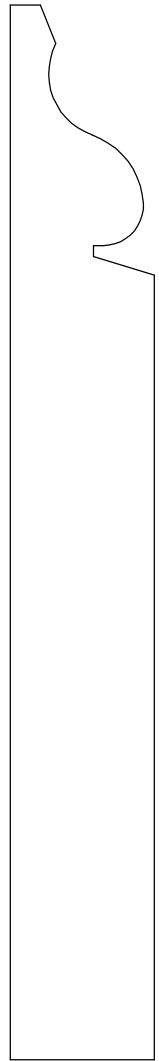

HM729
3/4" x 5 1/2"

HURDER MILLWORK

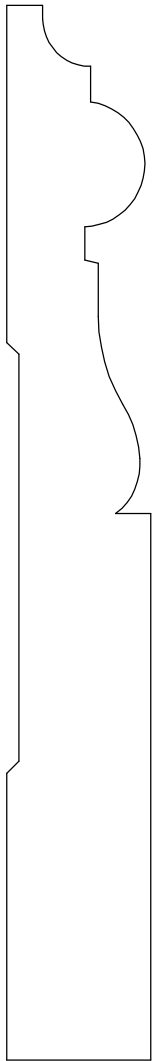

HM730

3/4" x 5 1/2"

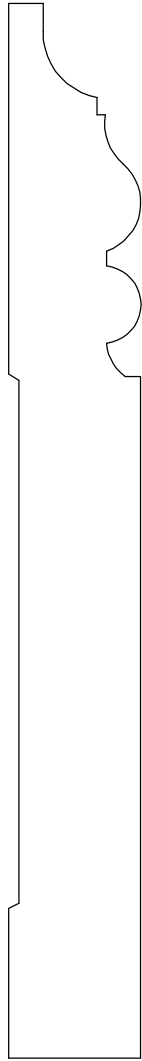

HM731

1 1/16" x 5 1/2"

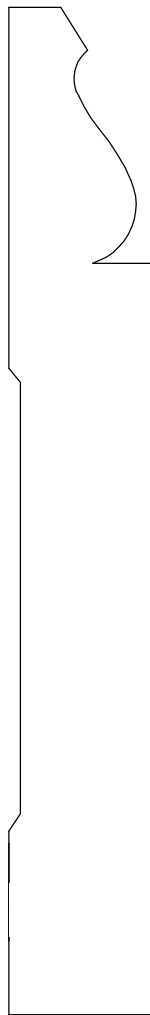

HM732

3/4" x 5 1/4"

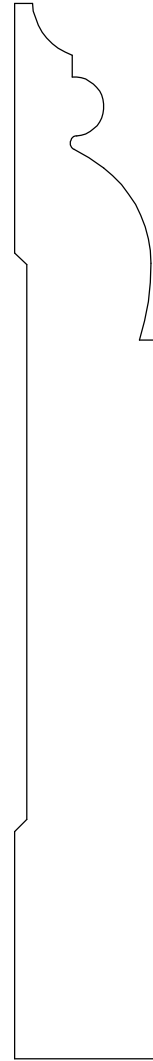

HM733

3/4" x 5 1/2"

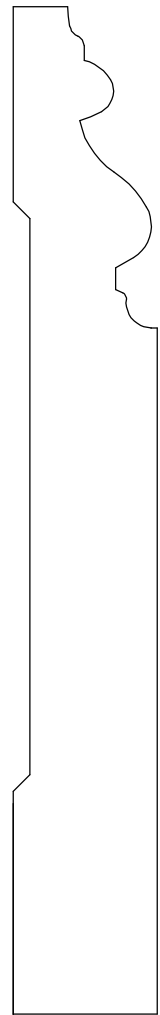

HM734

3/4" x 5 1/4"

HURDER MILLWORK

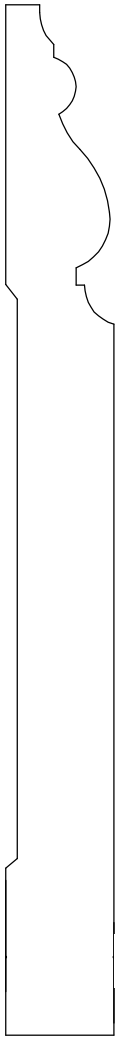

HM735

9/16" x 5 3/8"



HM736

3/4" x 5 1/4"

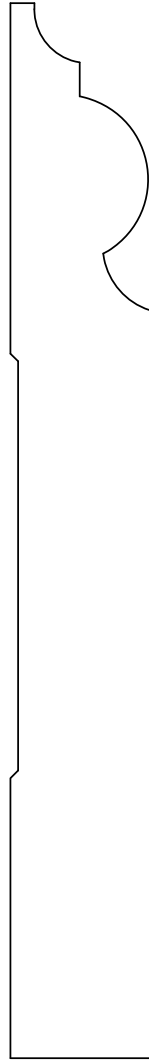

HM737

3/4" x 5 1/2"



HM738

3/4" x 5 1/2"

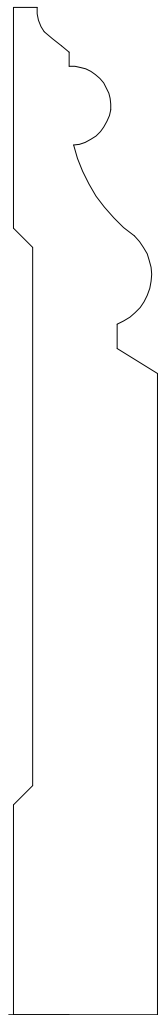

HM739

3/4" x 5 1/4"

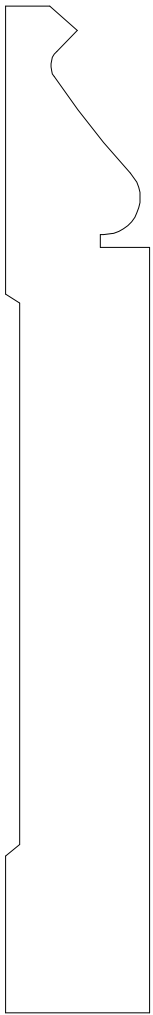

HM740

3/4" x 5 1/4"



HM741

3/4" x 5 1/8"



HM742

3/4" x 5 1/2"

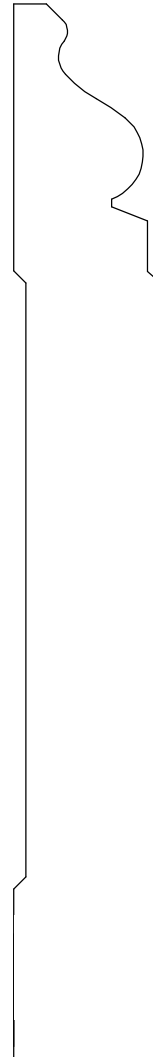

HM743

3/4" x 5 1/2"

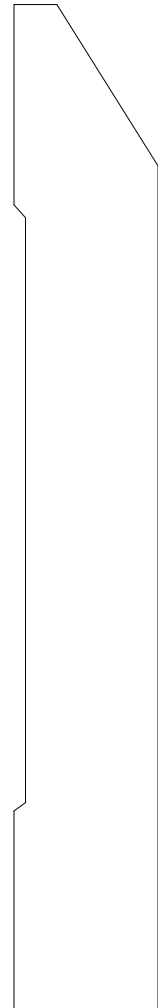

HM744

3/4" x 5 1/4"

HURDER MILLWORK

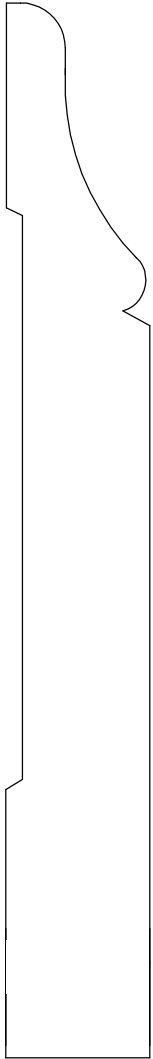

HM745

3/4" x 5 1/2"



HM746

9/16" x 5 1/4"

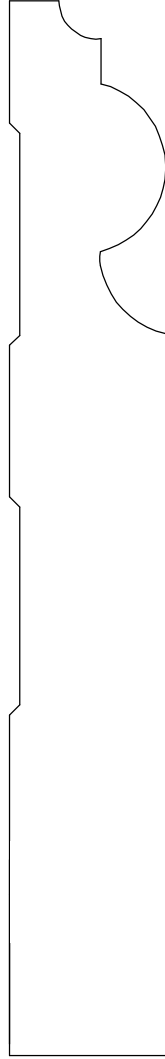

HM747

3/4" x 5 1/2"

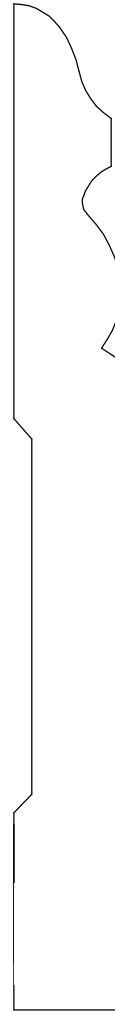

HM748

9/16" x 5 1/4"

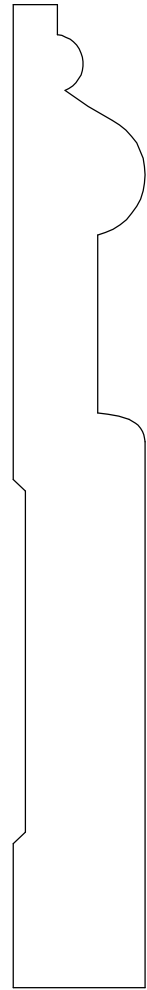

HM749

1 1/16" x 5 1/8"

HURDER MILLWORK

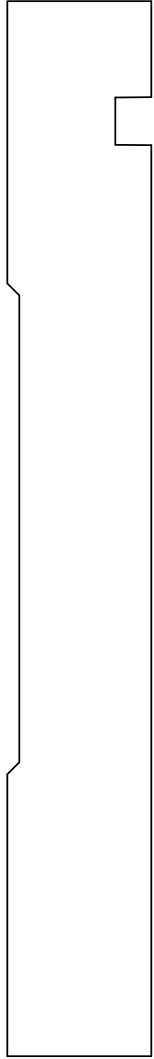

HM750

3/4" x 5 1/2"



HM751

3/4" x 5 1/8"

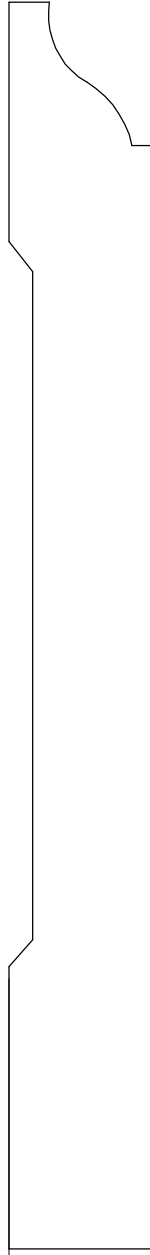

HM752

3/4" x 6 1/2"



HM753

3/4" x 6 1/2"

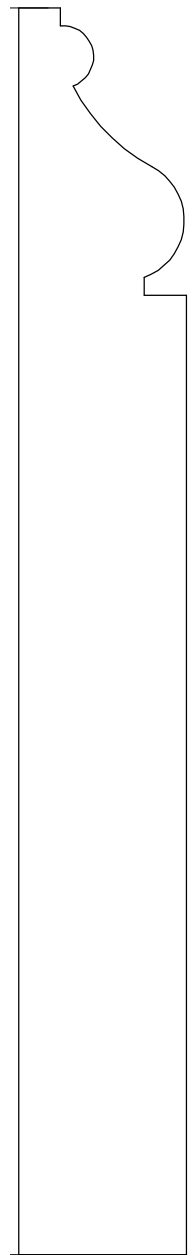

HM754

7/8" x 6 1/2"

no RX01647

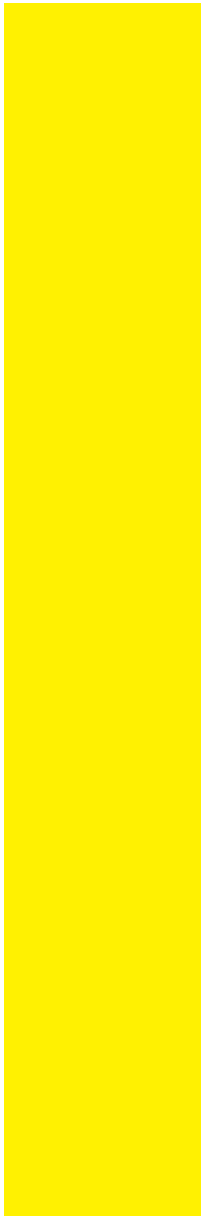

HM755

1" x 6 1/2"



HM756

3/4" x 6 11/16"

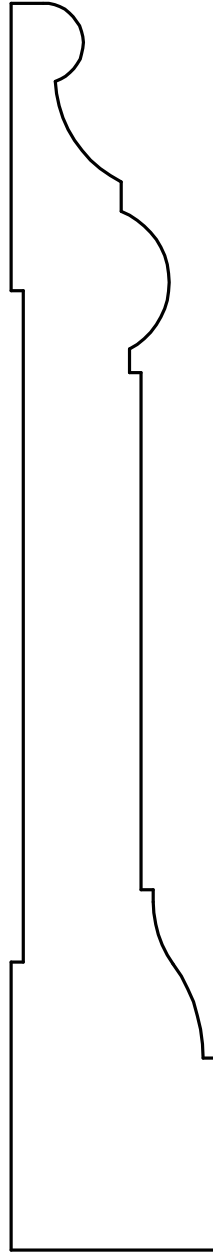

HM757

1 1/16" x 6 1/2"

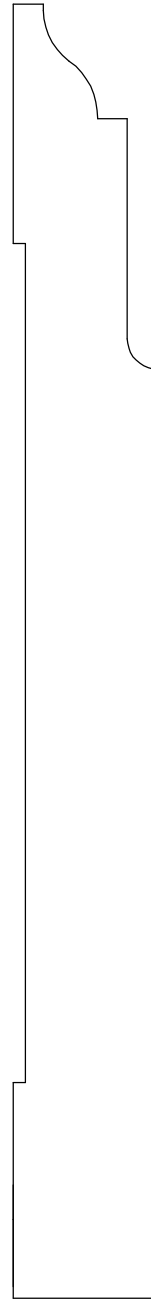

HM758

3/4" x 6 3/4"

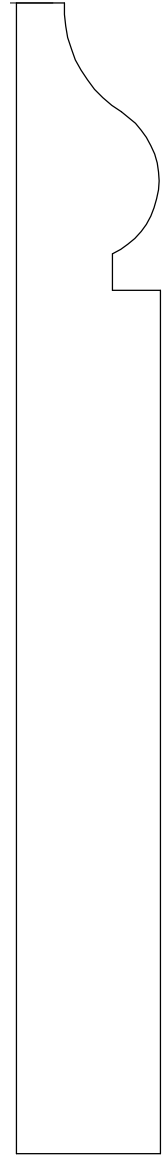

HM759

3/4" x 6"

HURDER MILLWORK

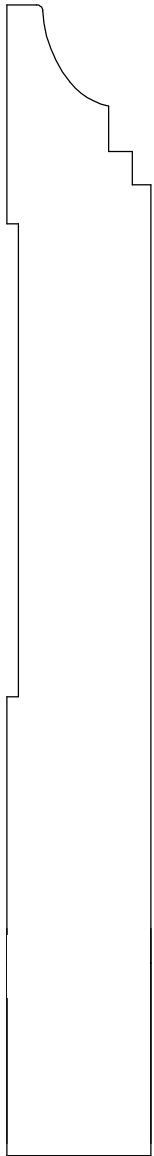

HM760
3/4" x 6"



HM761
3/4" x 6"

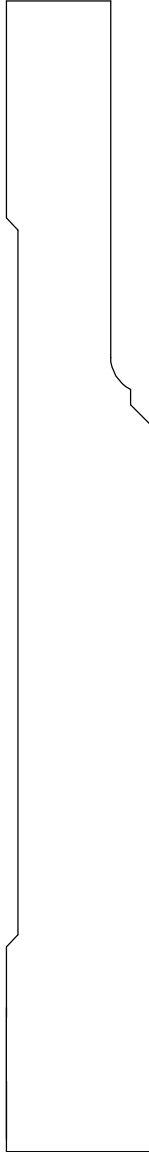

HM762
3/4" x 6"

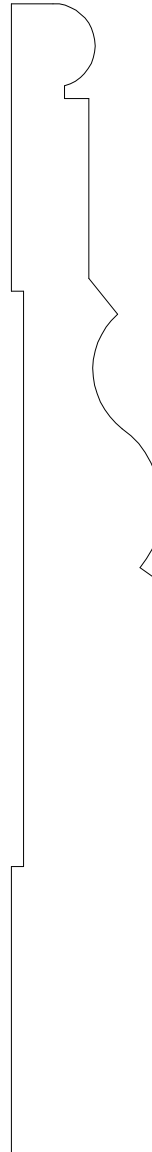

HM763
25/32" x 6"

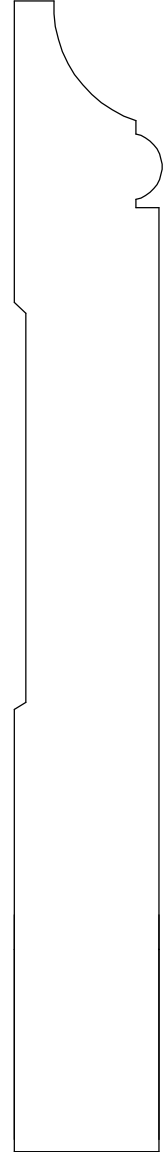

HM764
3/4" x 6"

HURDER MILLWORK

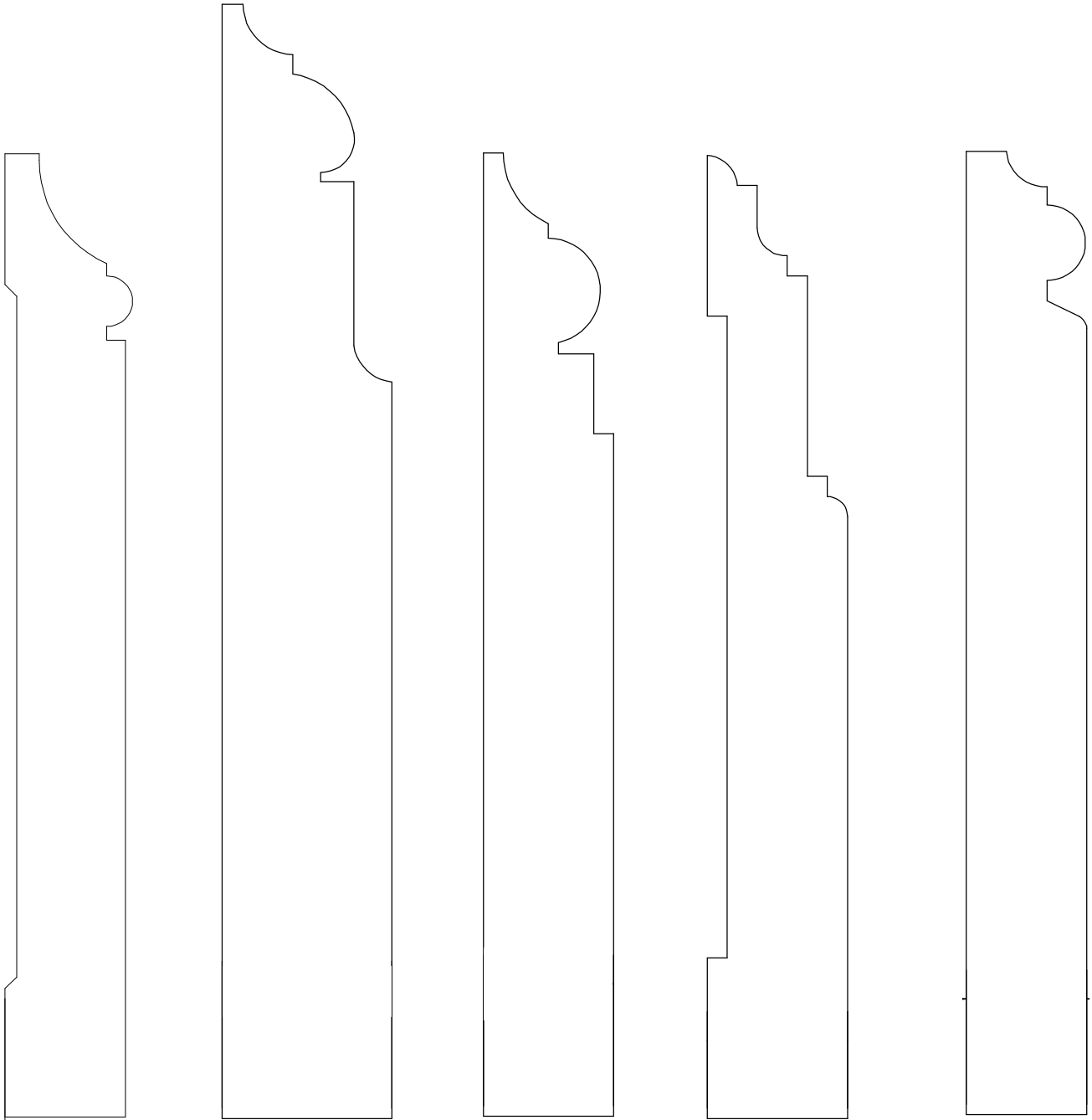

HM765

3/4" x 6"

HM766

1 1/16" x 6 15/16"

HM767

13/16" x 6"

HM768

7/8" x 6"

HM769

3/4" x 6"

HURDER MILLWORK

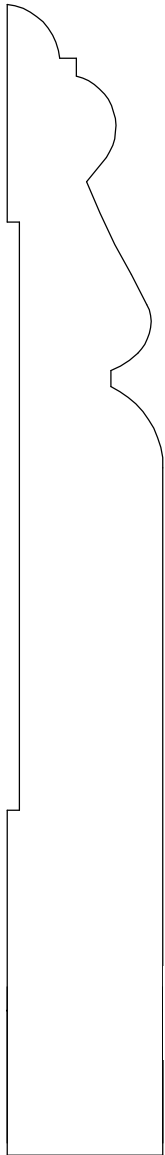

HM770

13/16" x 6"

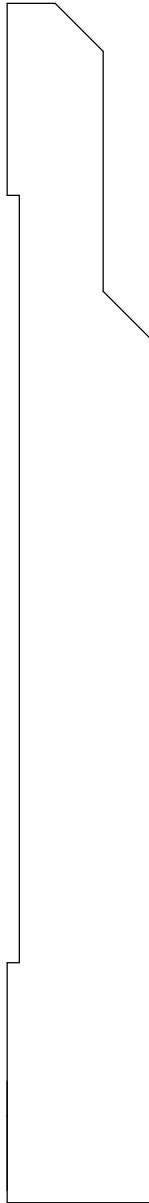

HM771

3/4" x 6 1/4"

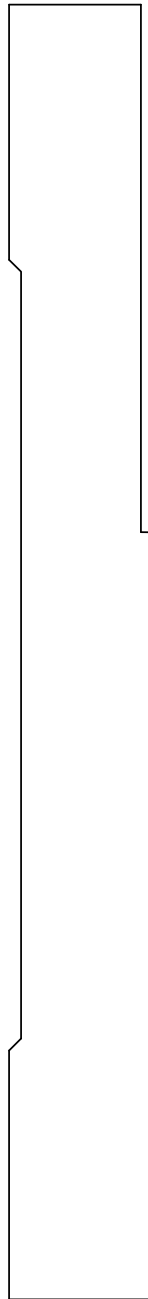

HM772

3/4" x 6 3/4"

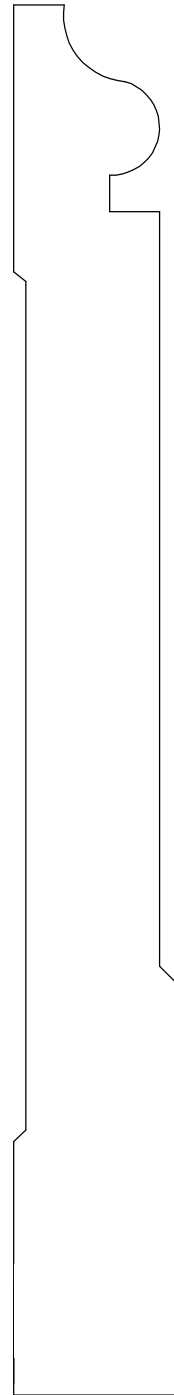

HM773

7/8" x 7 1/4"

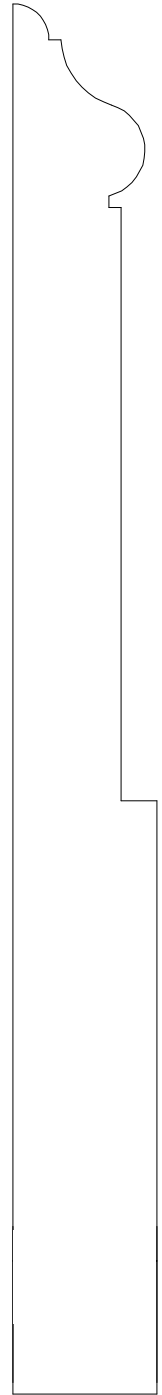

HM774

3/4" x 7 1/4"

**HURDER
MILLWORK**



HM775

27/32" x 7 1/4"



HM776

1 1/16" x 7 1/4"

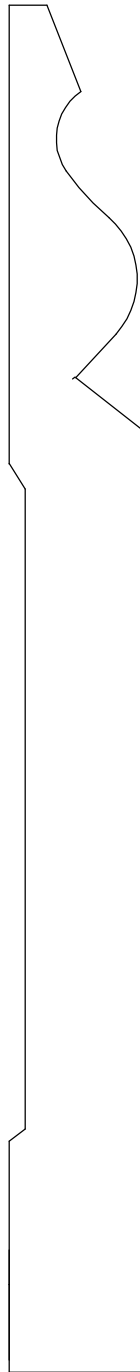

HM777

1 1/16" x 7 1/8"

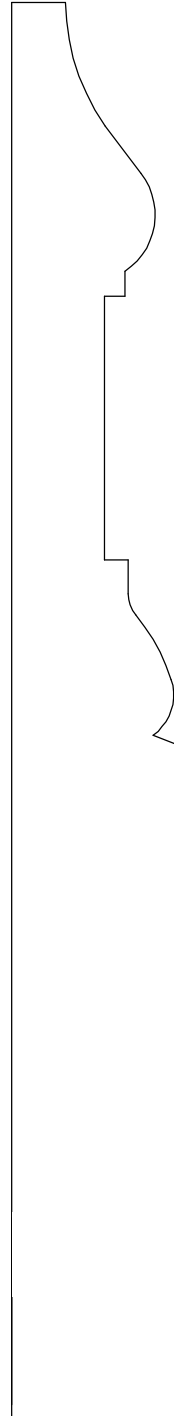

HM778

7/8" x 7 3/8"

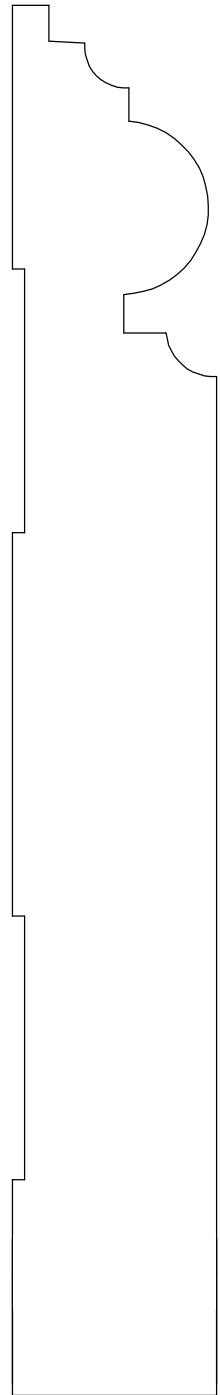

HM779

1 1/16" x 7 1/4"

HURDER MILLWORK

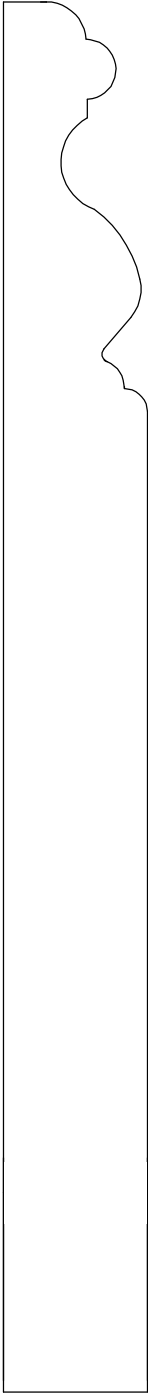

HM780
3/4" x 7 1/4"

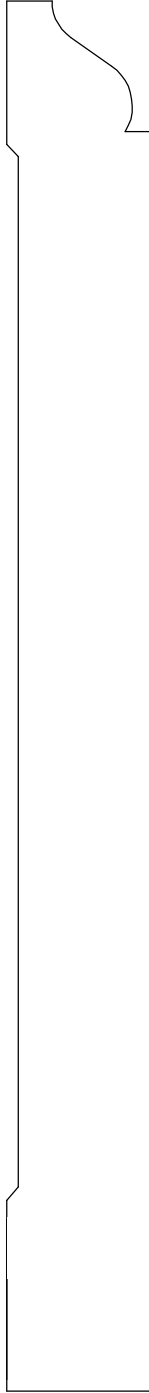

HM781
3/4" x 7 1/4"

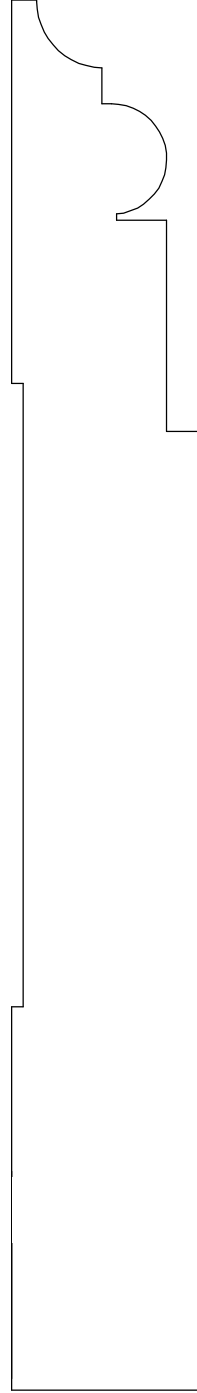

HM782
1" x 7 1/4"

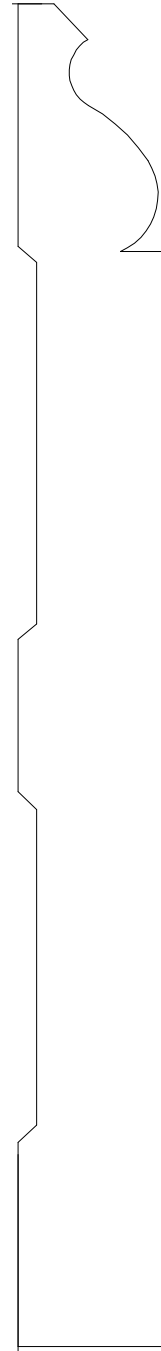

HM783
3/4" x 7"

**HURDER
MILLWORK**

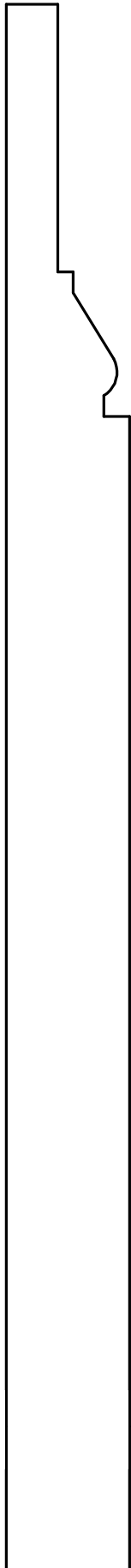

HM784
3/4" x 9 1/2"



HM785
3/4" x 8"

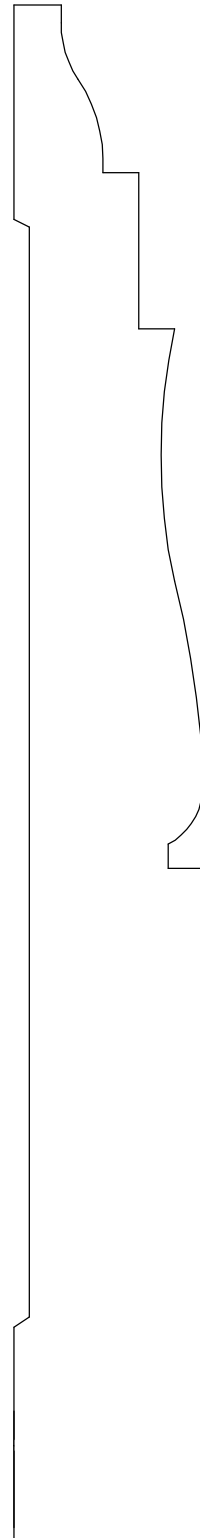

HM786
1" x 8"

**HURDER
MILLWORK**

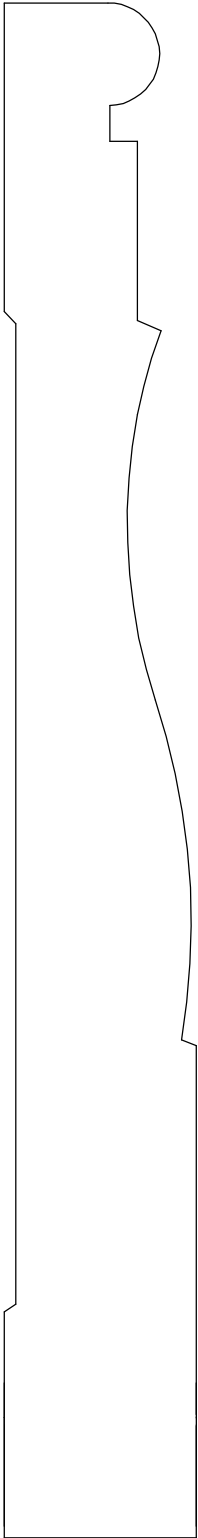

HM787
1" x 8"

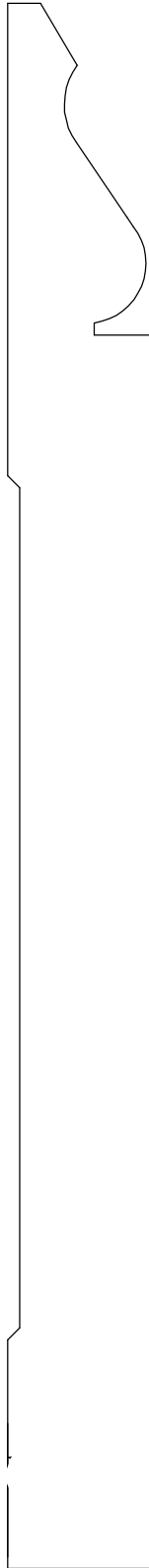

HM788
3/4" x 8 1/4"

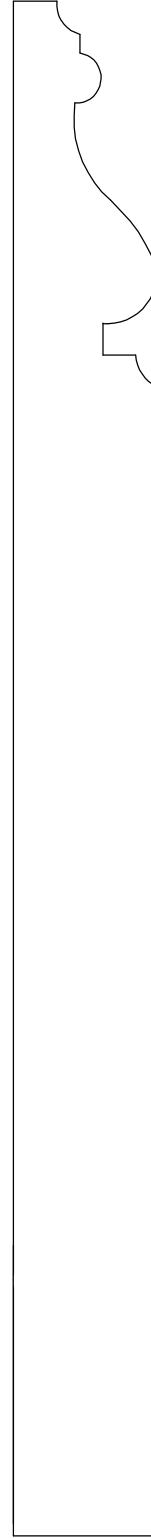

HM789
3/4" x 8"

**HURDER
MILLWORK**



HM790
27/32" x 8 9/16"

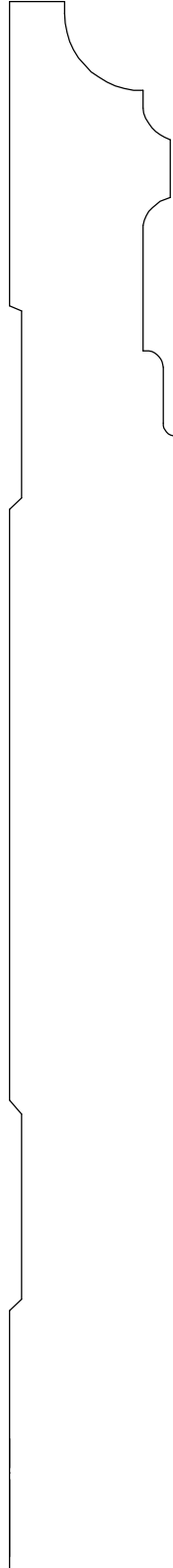

HM791
7/8" x 8 1/4"



HURDER MILLWORK

www.HurderMillwork.com

CASING PROFILES



HURDER MILLWORK

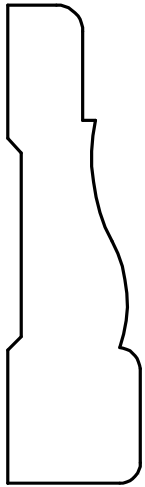

IN-STOCK

**Colonial
HM801**

11/16" x 2 1/2"



IN-STOCK

**Newport
HM802**

5/8" x 2 7/16"

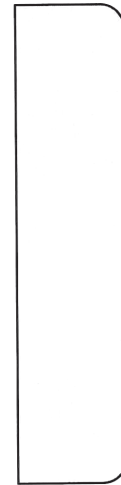

IN-STOCK

**Eased Edge
HM803**

9/16" x 2 1/2"

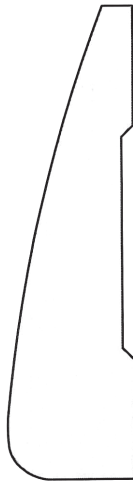

IN-STOCK

**Clamshell
HM804**

11/16" x 2 1/2"

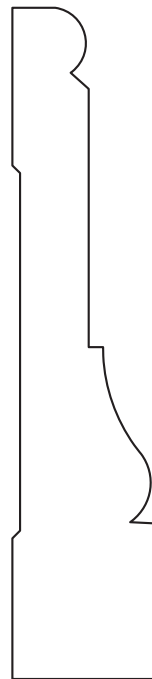

IN-STOCK

HM805

3/4" x 3 1/2"

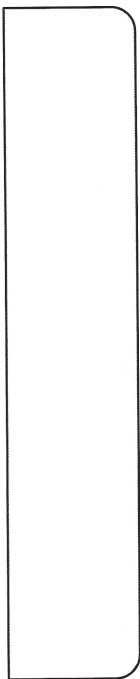

IN-STOCK

**Eased Edge
HM806**

3 11/16" x 3 1/2"

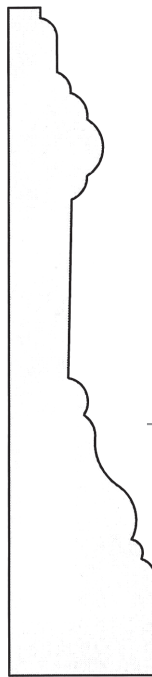

IN-STOCK

**Alexander
HM807**

3/4" x 3 1/2"



IN-STOCK

**Colonial
HM808**

3/4" x 3 1/2"

HURDER MILLWORK



IN-STOCK

**Stafford
HM809**

5/8" x 3 3/8"



IN-STOCK

**Stafford
HM810**

3/4" x 3 1/2"

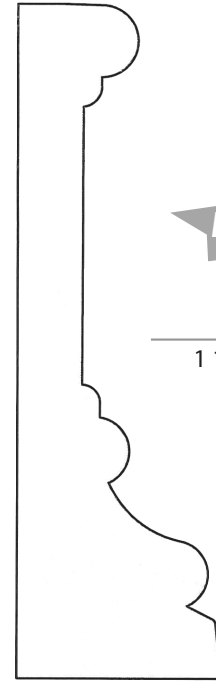

IN-STOCK

**Vindsor
HM811**

1 1/16" x 3 1/2"

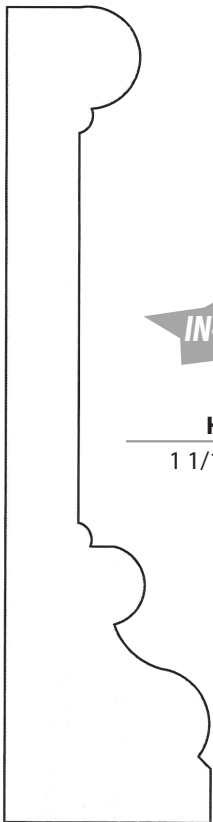

IN-STOCK

**Vindsor
HM812**

1 1/16" x 4 1/4"

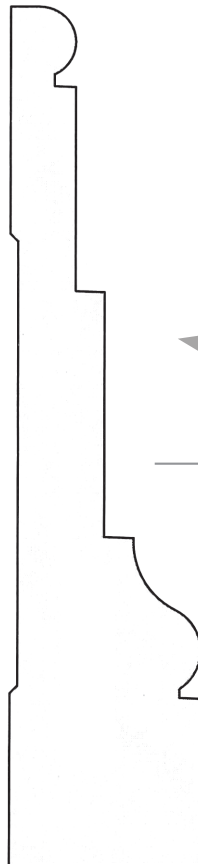

IN-STOCK

**Essex
HM813**

1" x 4 1/2"

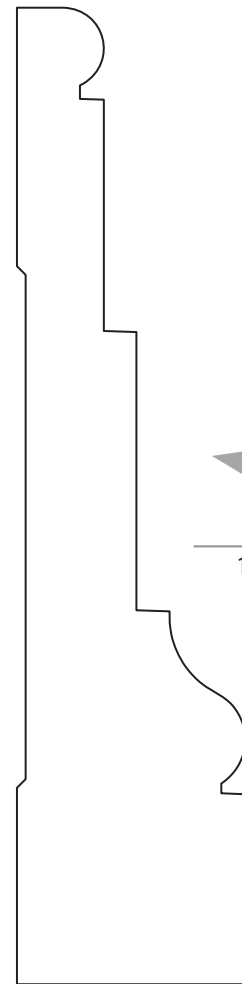

IN-STOCK

HM814

1 1/16" x 4 1/2"

HURDER MILLWORK

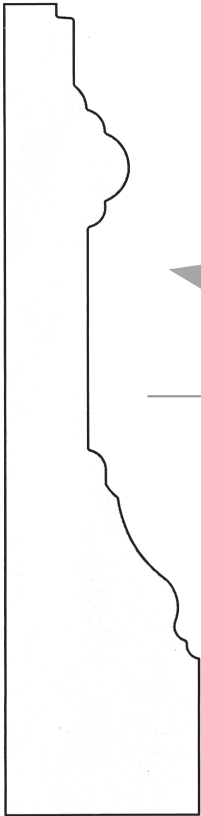

IN-STOCK

**Alexander
HM815**

1" x 4 1/4"

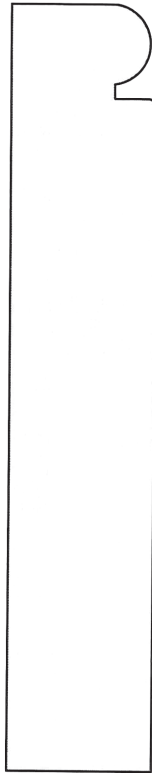

IN-STOCK

**Beaded
HM816**

3/4" x 3 1/2"

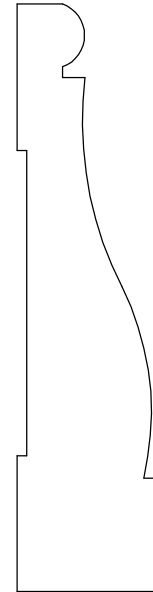

HM821

3/4" x 2 1/16"

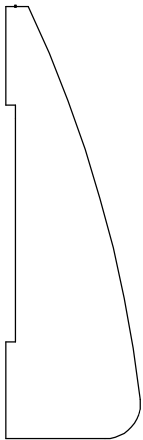

**Clamshell
HM822**

11/16" x 2 1/4"

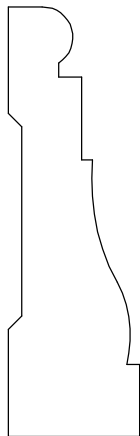

HM823

11/16" x 2 1/4"

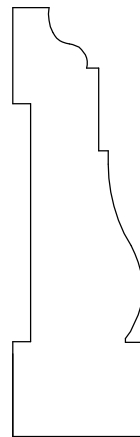

HM824

11/16" x 2 1/4"

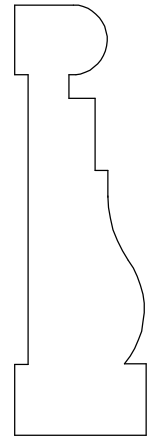

HM825

11/16" x 2 1/4"

HURDER MILLWORK

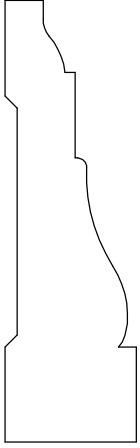

HM826

11/16" x 2 5/16"

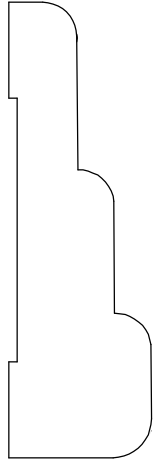

HM827

3/4" x 2 3/8"

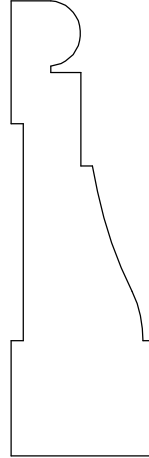

HM828

3/4" x 2 3/8"

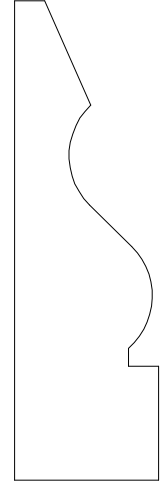

HM829

3/4" x 2 1/2"

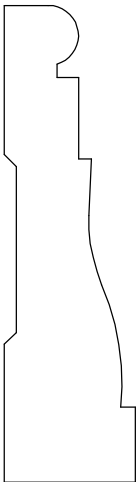

HM830

11/16" x 2 1/2"

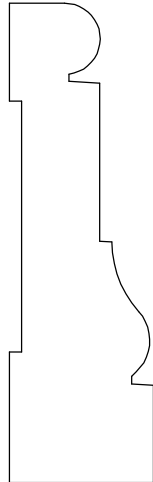

HM831

3/4" x 2 1/2"

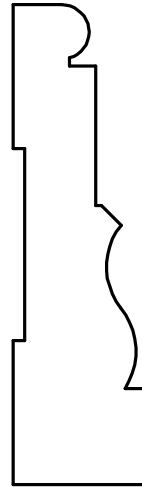

HM832

11/16" x 2 1/2"

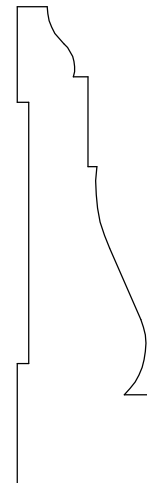

HM833

11/16" x 2 1/2"

HURDER MILLWORK

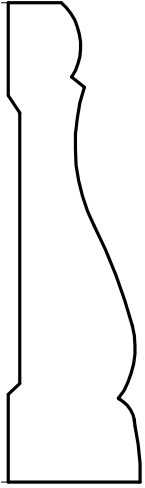

HM834

11/16" x 2 1/2"

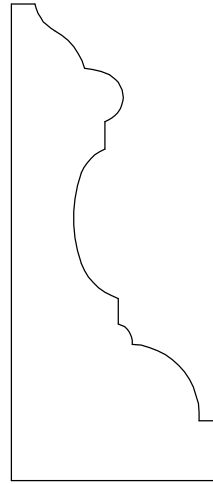

HM835

1 1/16" x 2 1/2"

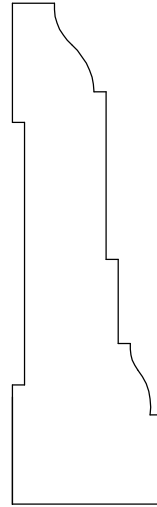

HM836

2 5/8" x 24/32"

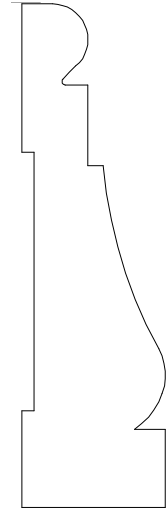

HM837

3/4" x 2 5/8"

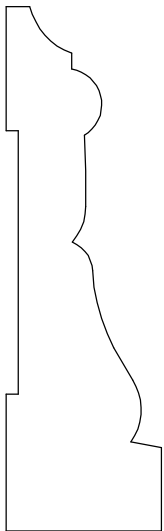

HM838

13/16" x 2 3/4"

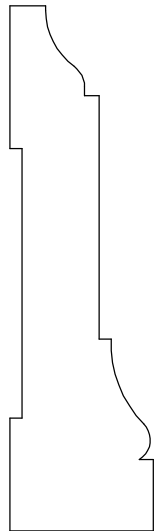

HM839

3/4" x 2 3/4"

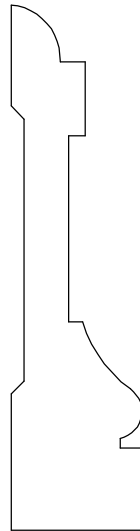

HM840

11/16" x 2 3/4"

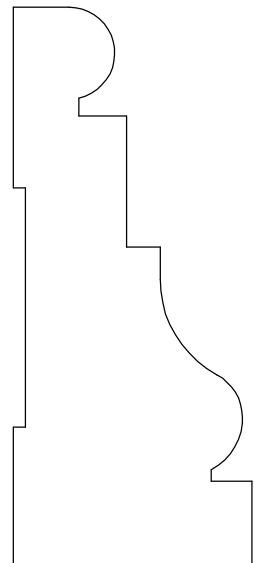

HM841

1 1/4" x 2 15/16"

HURDER MILLWORK



Concord
HM850
5/8" x 3"

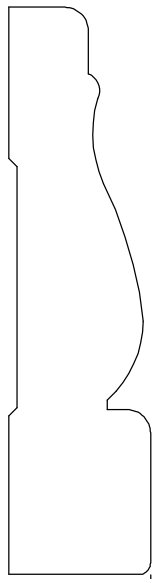

HM851
3/4" x 3"

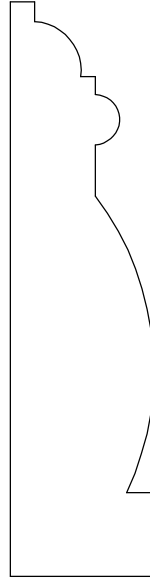

HM852
3/4" x 3"

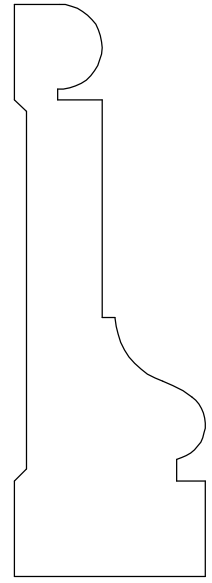

HM854
1" x 3"

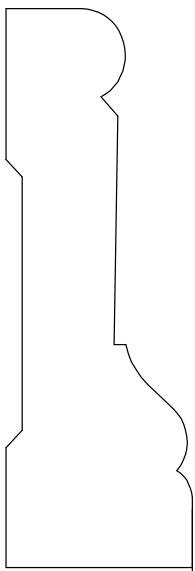

HM855
1" x 3"

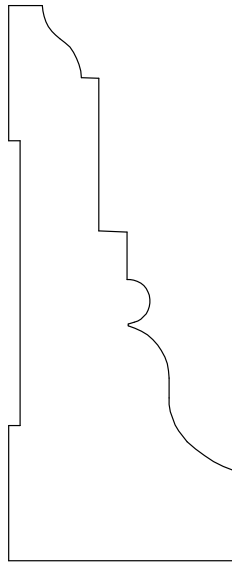

HM856
1 1/4" x 3 1/16"

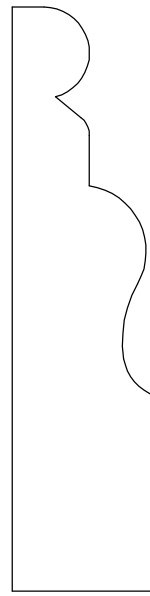

HM857
3/4" x 3 1/16"

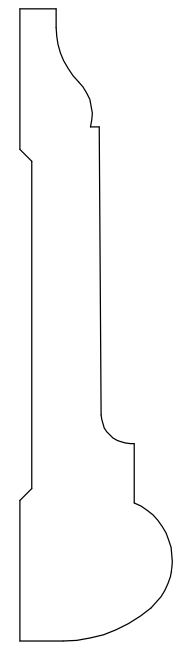

HM858
1 1/16" x 3 1/8"

HURDER MILLWORK

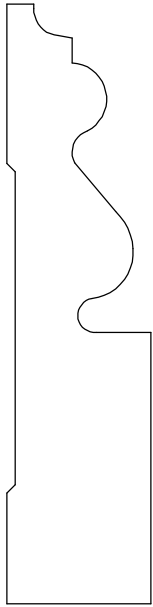

HM859

3/4" x 3 1/8"

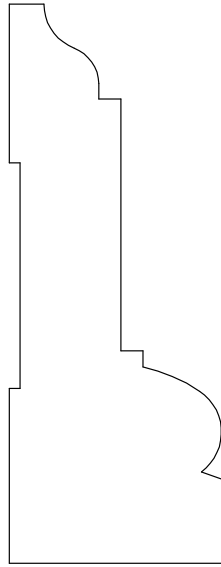

HM860

1 3/16" x 3 1/8"

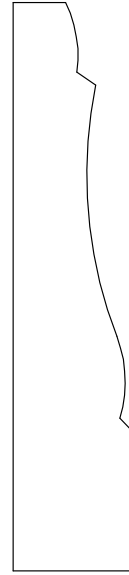

HM861

1 1/16" x 3 7/32"

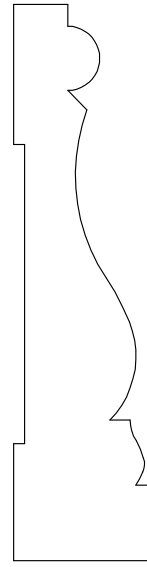

HM862

25/32" x 3 7/32"

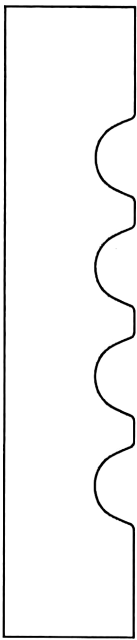

Rockport Fluted

HM863

1 1/16" x 3 1/4"

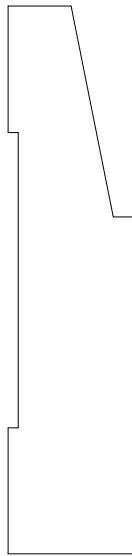

HM864

3/4" x 3 1/4"

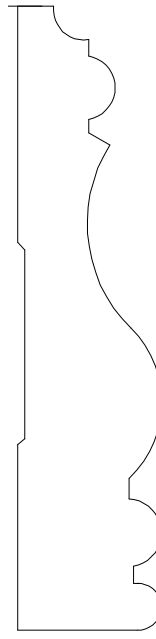

HM865

3/4" x 3 1/4"

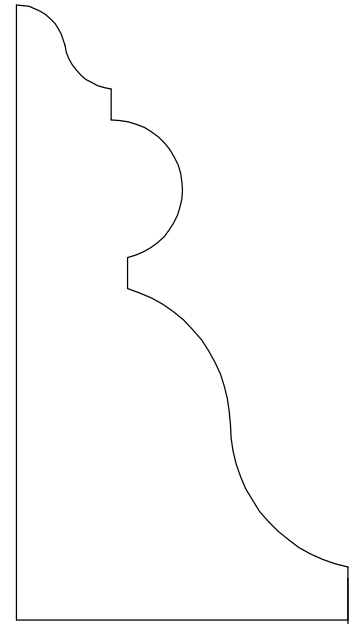

HM866

1 3/4" x 3 1/4"

HURDER MILLWORK

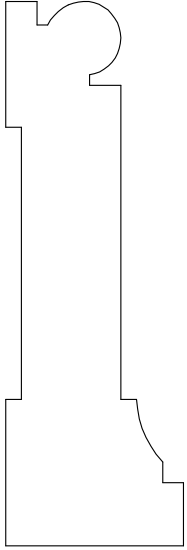

HM867

1 1/16" x 3 1/4"

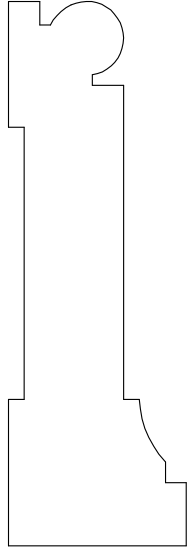

HM867

1 1/16" x 3 1/4"

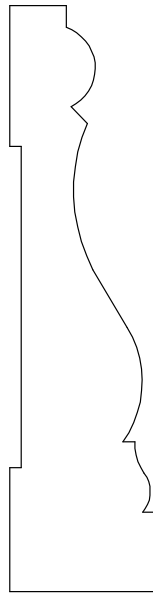

HM868

13/16" x 3 1/4"

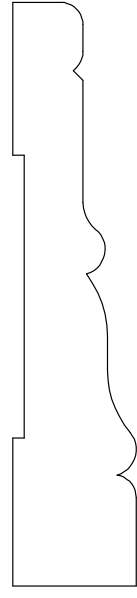

HM869

11/16" x 3 1/4"

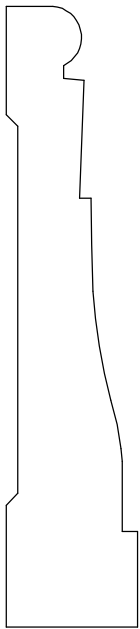

HM870

11/16" x 3 1/4"

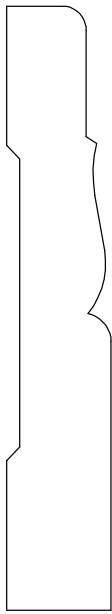

HM871

9/16" x 3 1/4"

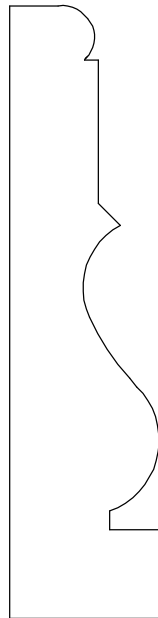

HM872

13/16" x 3 1/4"

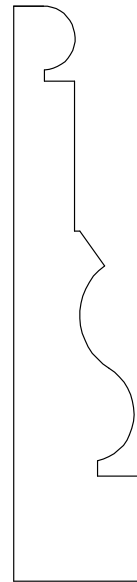

HM873

23/32" x 3 1/4"

HURDER MILLWORK

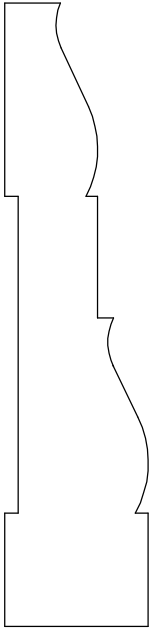

HM874

3/4" x 3 1/4"

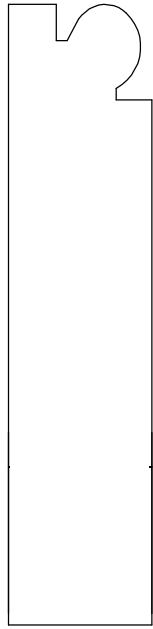

HM875

3/4" x 3 1/4"

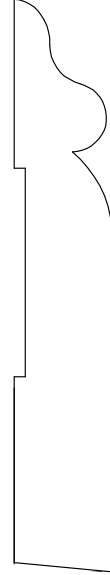

HM876

9/16" x 3 9/32"

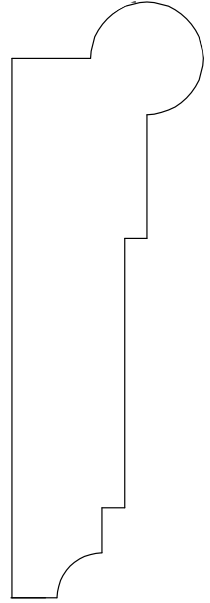

HM877

1 1/16" x 3 5/16"

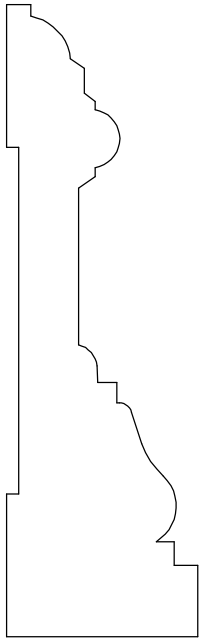

HM878

1" x 3 5/16"

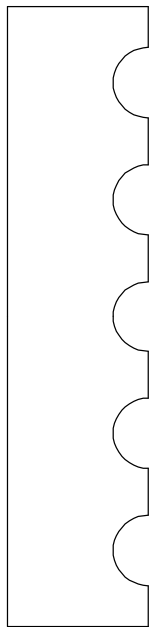

HM879

3/4" x 3 5/16"

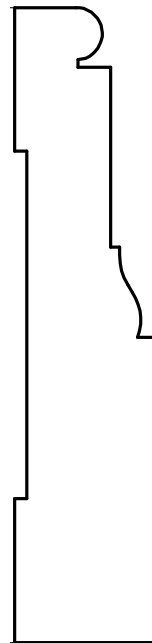

HM880

3/4" x 3 5/16"

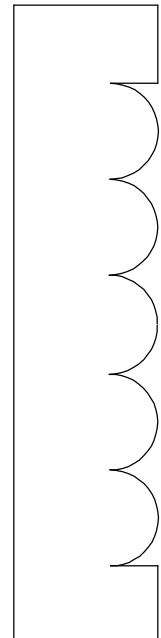

HM881

3/4" x 3 5/16"

HURDER MILLWORK

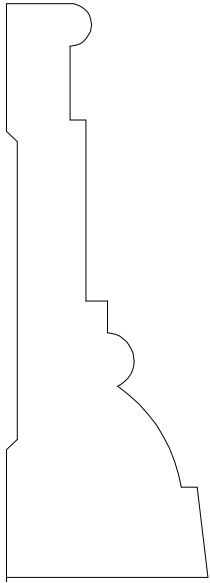

HM882

1 3/16" x 3 3/8"

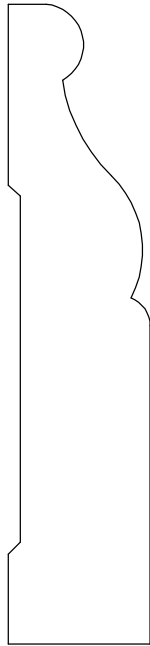

HM883

3/4" x 3 3/8"



Stafford
HM884

5/8" x 3 3/8"

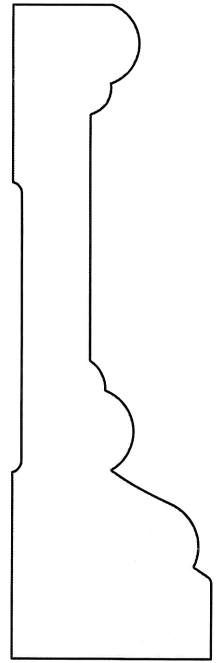

Windsor
HM885

1 1/16" x 3 3/8"

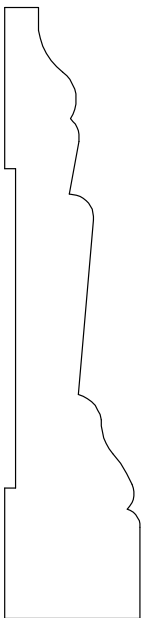

HM886

3/4" x 3 3/8"

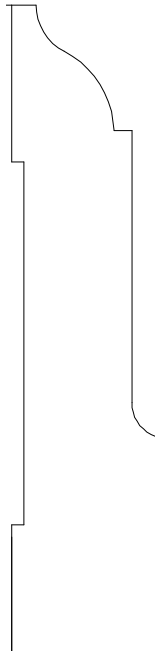

HM887

3/4" x 3 3/8"

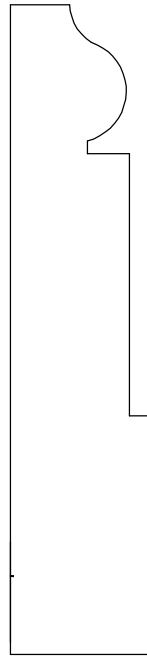

HM888

3/4" x 3 3/8"

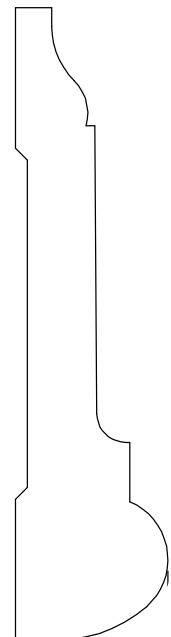

HM889

13/16" x 3 3/8"

HURDER MILLWORK

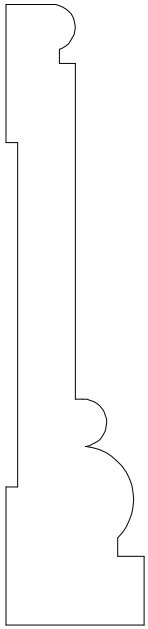

HM890

3/4" x 3 3/8"

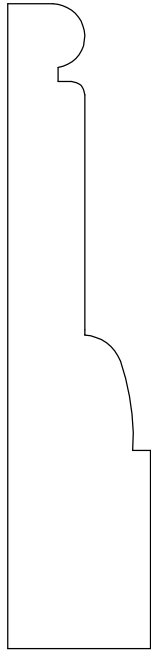

HM891

3/4" x 3 3/8"

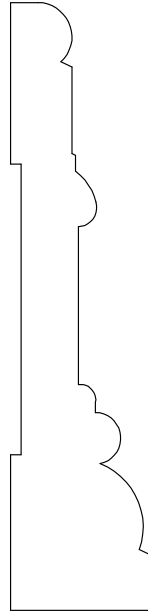

HM892

13/16" x 3 15/16"

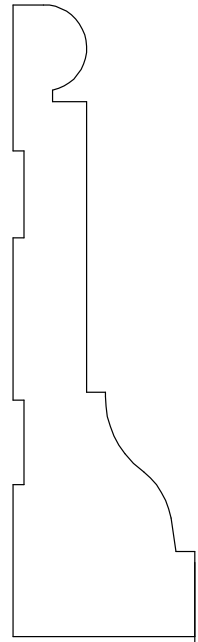

HM893

1" x 3 15/32"

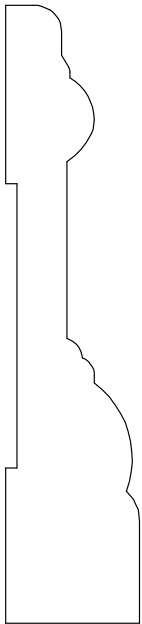

HM894

3/4" x 3 15/32"

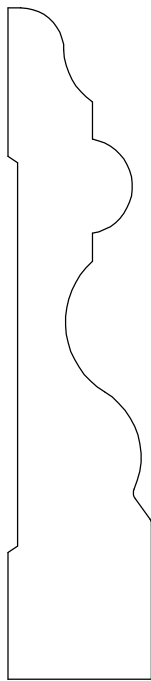

HM895

3/4" x 3 1/2"

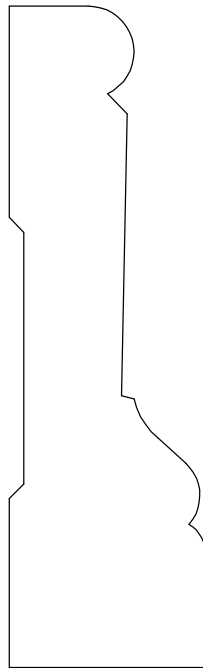

HM896

1 1/16" x 3 1/2"

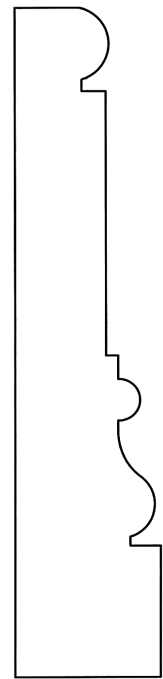

HM897

3/4" x 3 1/2"

HURDER MILLWORK

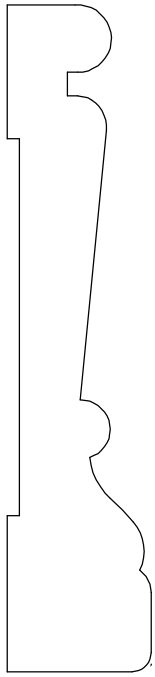

HM898
3/4" x 3 1/2"

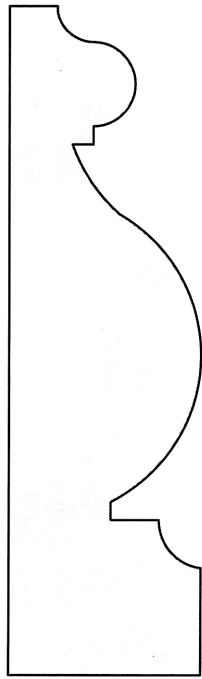

Lexington
HM899
1" x 3 1/2"

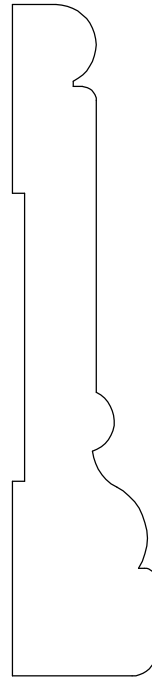

HM900
1" x 3 1/2"

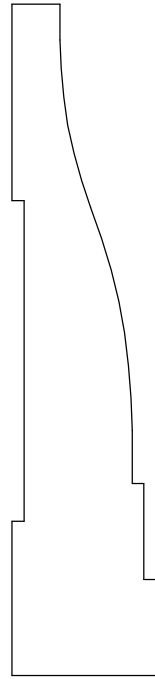

HM901
3/4" x 3 1/2"

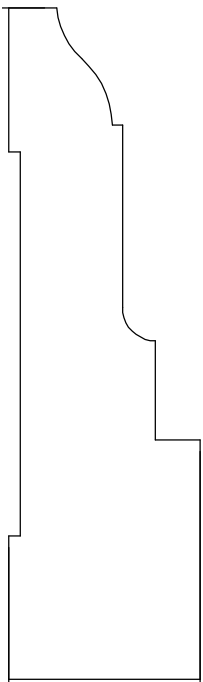

HM902
1" x 3 1/2"

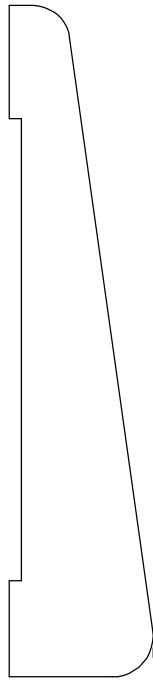

HM903
3/4" x 3 1/2"

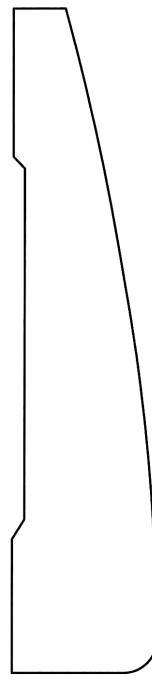

HM904
3/4" x 3 1/2"

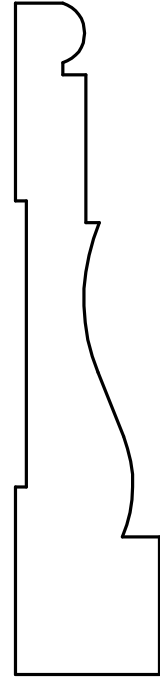

HM905
3/4" x 3 1/2"

HURDER MILLWORK

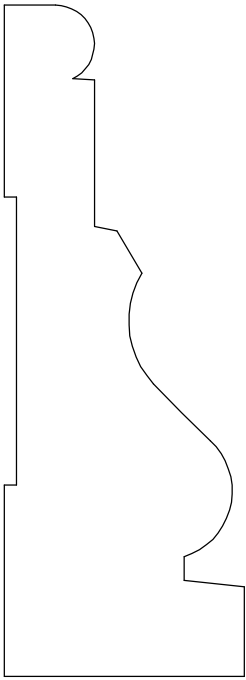

HM906

1 1/4" x 3 1/2"

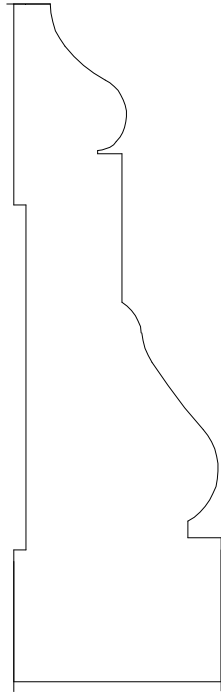

HM907

1 1/16" x 3 1/2"

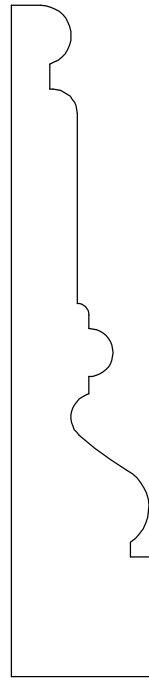

HM908

3/4" x 3 1/2"

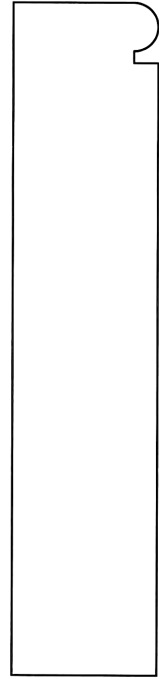

HM909

3/4" x 3 1/2"

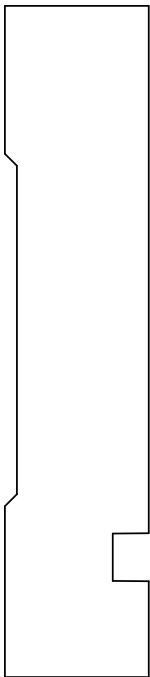

HM910

3/4" x 3 1/2"

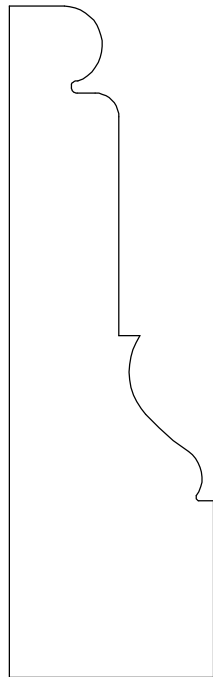

HM911

1 1/16" x 3 1/2"

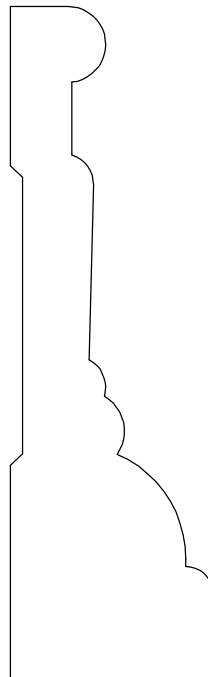

HM912

1 1/16" x 3 1/2"

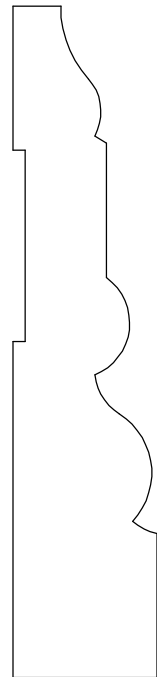

HM914

3/4" x 3 1/2"

HURDER MILLWORK

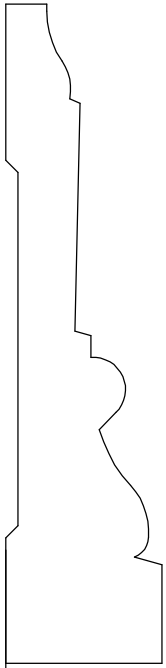

HM915

13/16" x 3 1/2"

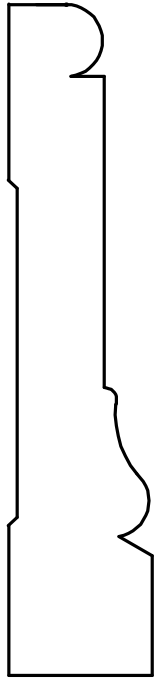

HM917

3/4" x 3 1/2"

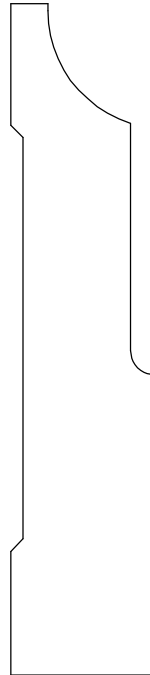

HM918

3/4" x 3 1/2"

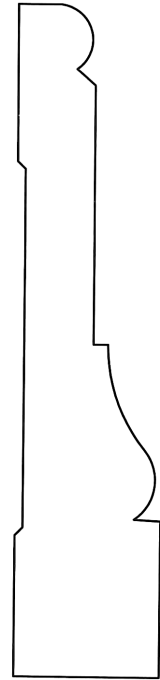

HM919

3/4" x 3 1/2"

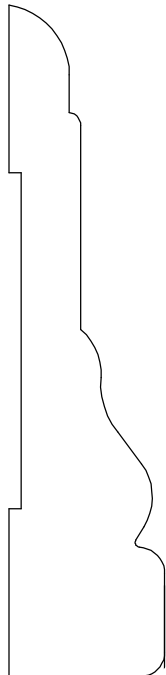

HM920

13/16" x 3 1/2"

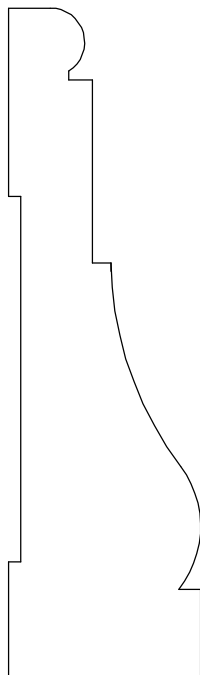

HM921

1" x 3 1/2"

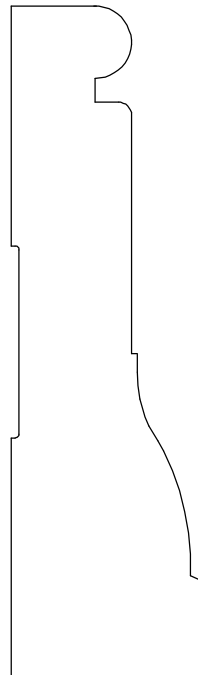

HM922

1" x 3 1/2"

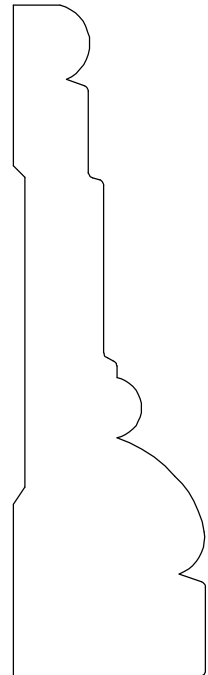

HM923

1" x 3 1/2"

HURDER MILLWORK

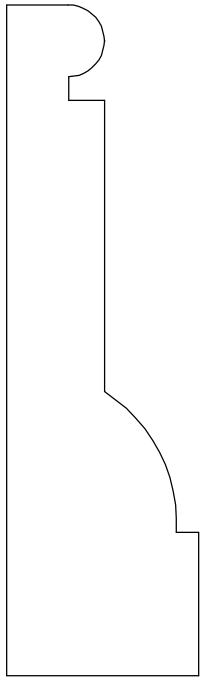

HM924

1" x 3 1/2"

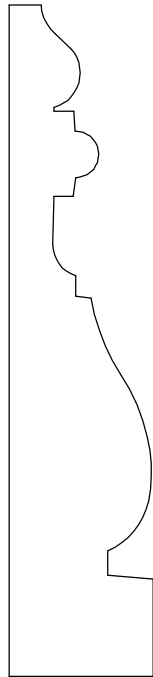

HM925

3/4" x 3 1/2"

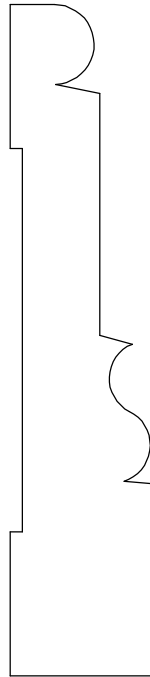

HM926

3/4" x 3 1/2"

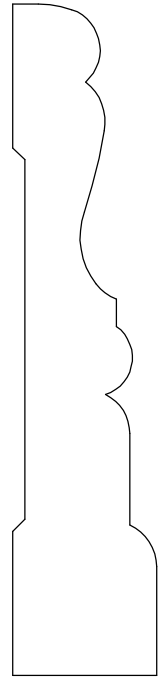

HM927

3/4" x 3 1/2"

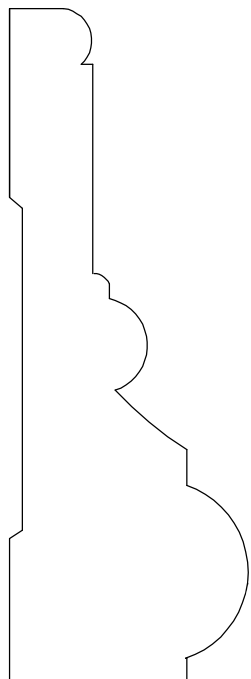

HM928

1 1/4" x 3 1/2"

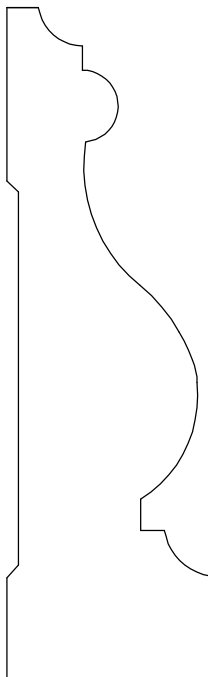

HM929

1 1/16" x 3 1/2"

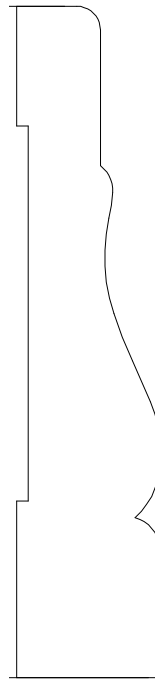

HM930

3/4" x 3 1/2"

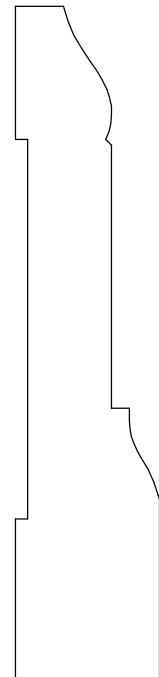

HM931

3/4" x 3 1/2"

HURDER MILLWORK

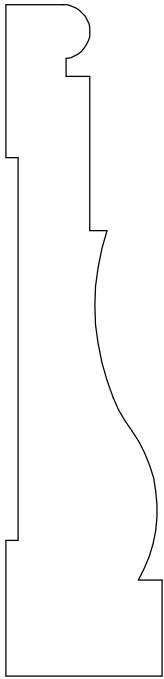

HM932

13/16" x 3 1/2"

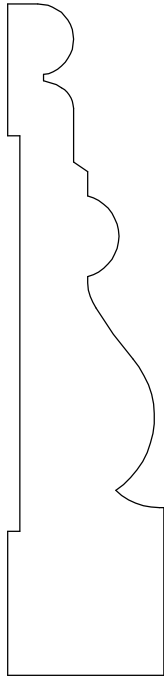

HM933

13/16" x 3 1/2"

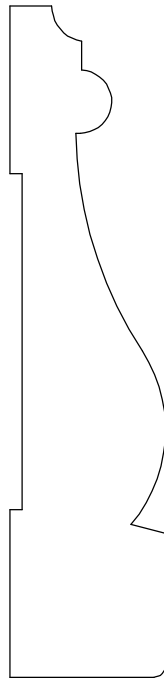

HM934

13/16" x 3 1/2"

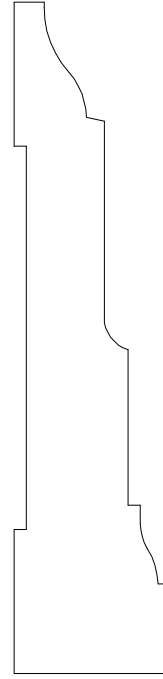

HM935

13/16" x 3 1/2"

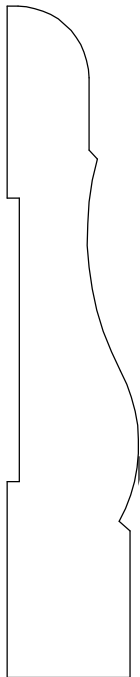

HM936

11/16" x 3 1/2"

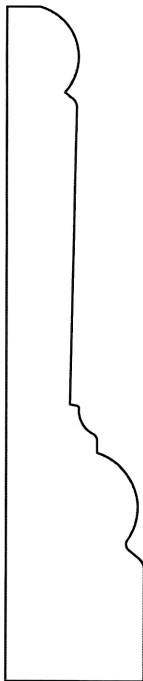

Dover
HM937

11/16" x 3 1/2"

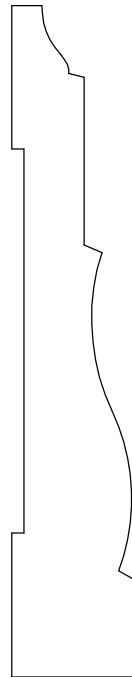

HM938

21/32" x 3 1/2"

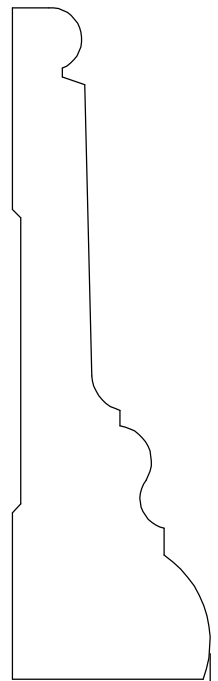

HM939

1 1/32" x 3 1/2"

HURDER MILLWORK

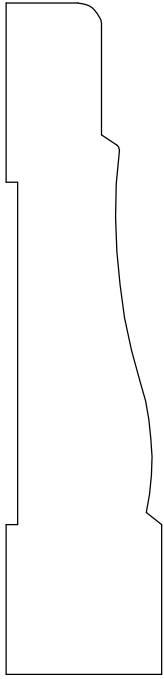

HM940

13/16" x 3 1/2"

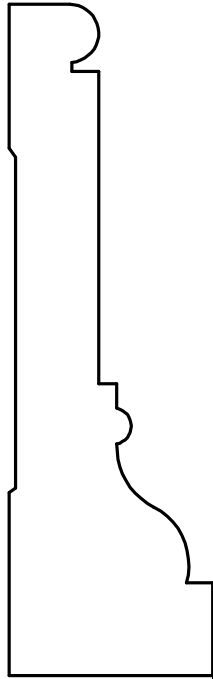

HM941

1 1/16" x 3 1/2"

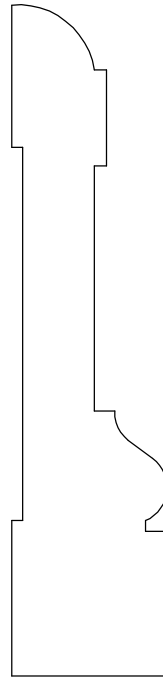

HM942

13/16" x 3 1/2"

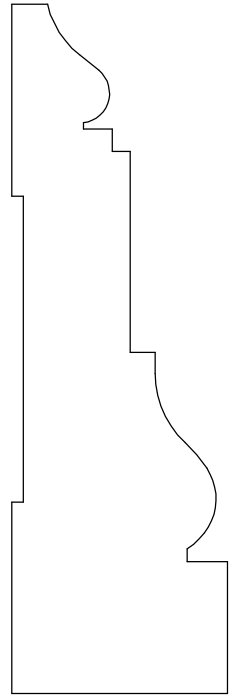

HM943

1 1/8" x 3 19/32"

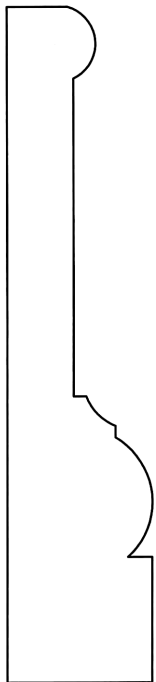

HM944

3/4" x 3 19/16"

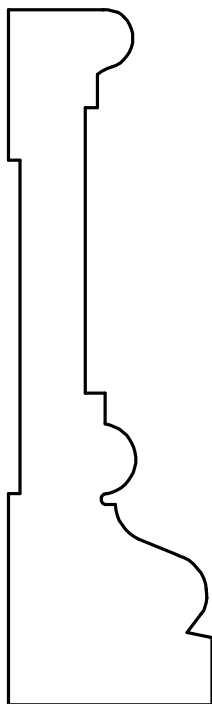

HM945

1 1/16" x 3 5/8"

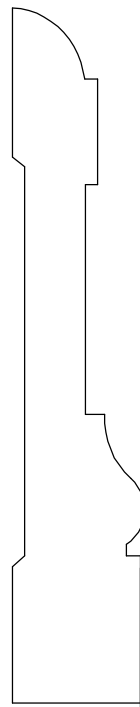

HM946

11/16" x 3 5/8"

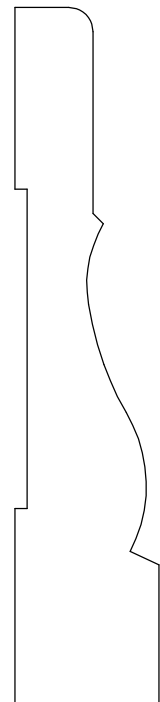

HM947

3/4" x 3 5/8"

HURDER MILLWORK

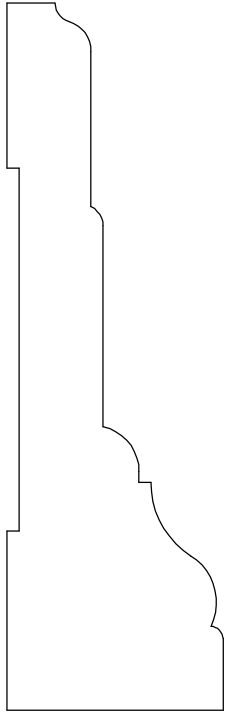

HM948

1 1/8" x 3 11/16"

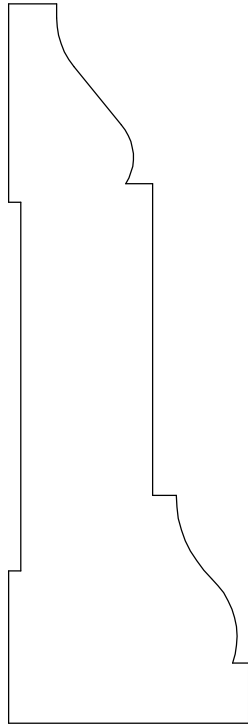

HM949

1 1/4" x 3 3/4"

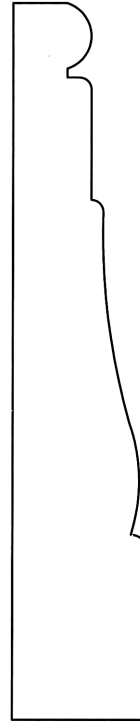

HM950

1 1/16" x 3 3/4"

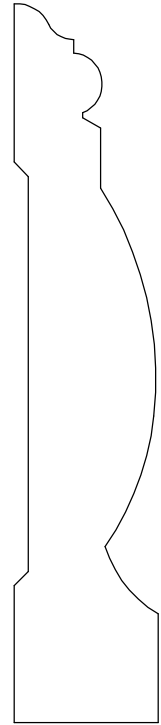

HM951

3/4" x 3 3/4"

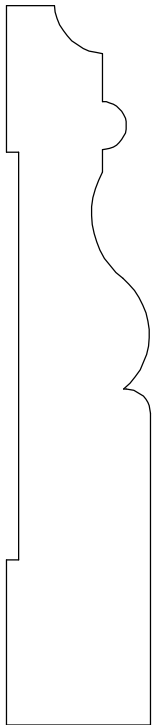

HM952

3/4" x 3 3/4"

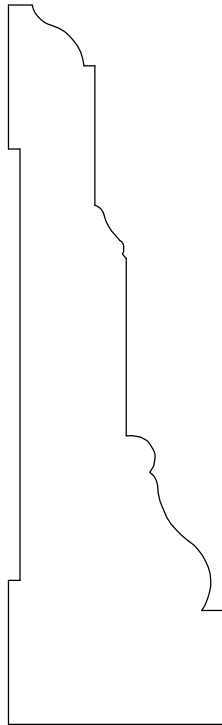

HM953

1 1/8" x 3 3/4"

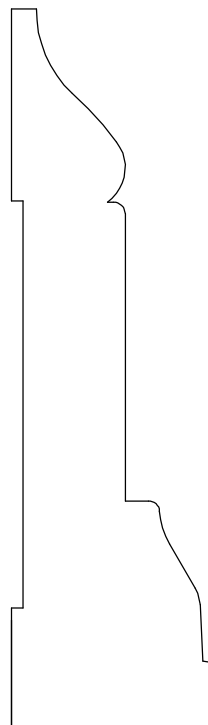

HM954

1 1/16" x 3 3/4"

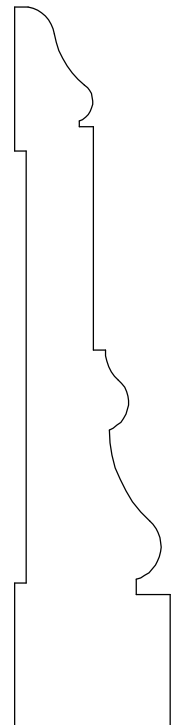

HM955

13/16" x 3 3/4"

HURDER MILLWORK

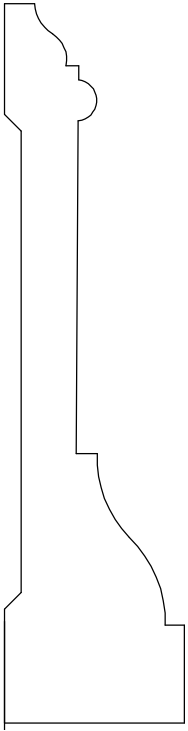

HM956

15/16" x 3 3/4"

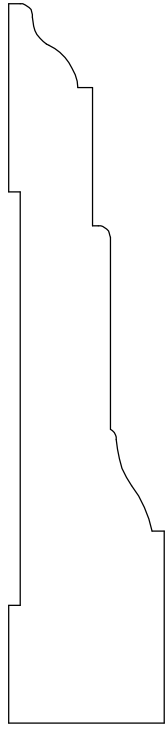

HM957

13/16" x 3 3/4"

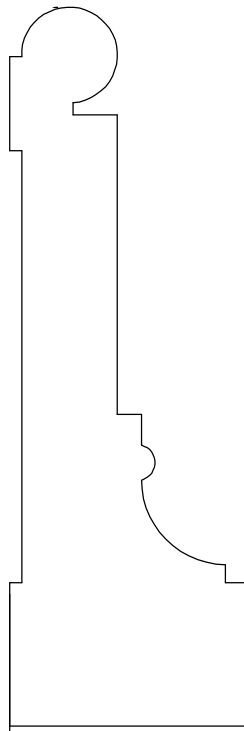

HM958

1 1/4" x 3 3/4"

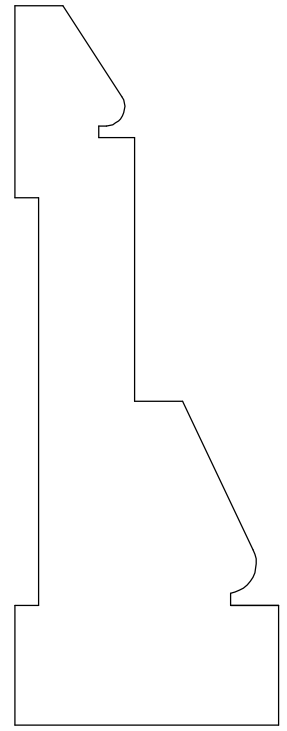

HM959

1 3/8" x 3 3/4"

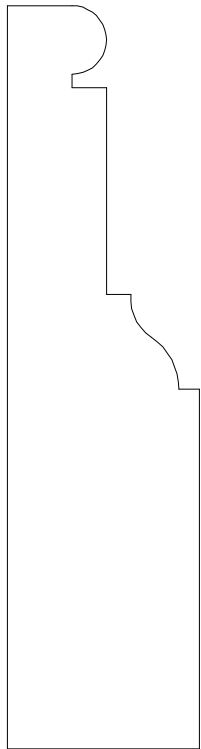

HM960

1" x 3 7/8"

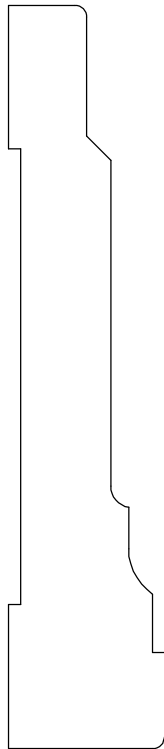

HM961

13/16" x 3 7/8"

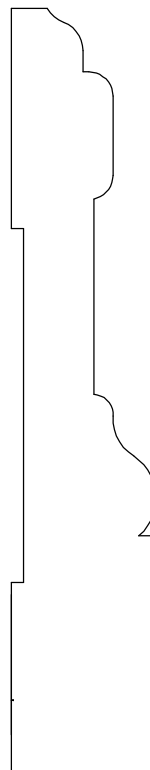

HM970

3/4" x 4"

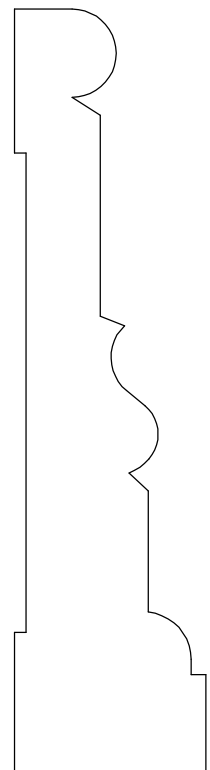

HM971

1" x 4"

HURDER MILLWORK

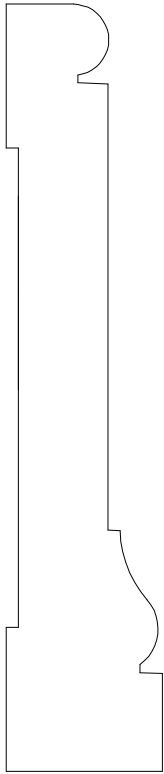

HM972

13/16" x 4"

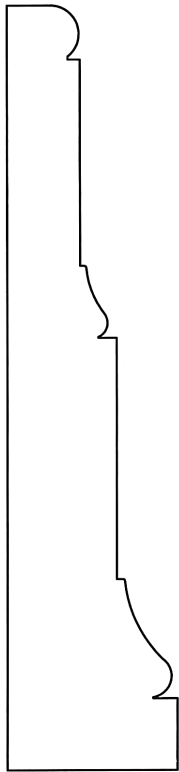

HM973

7/8" x 4"

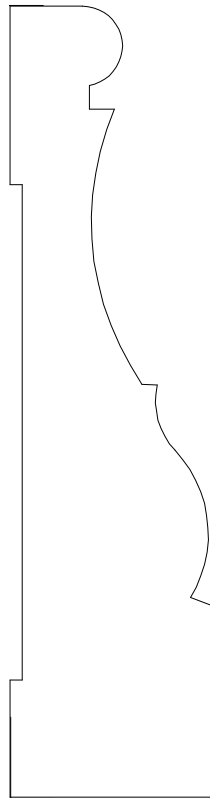

HM974

1 1/16" x 4 1/8"

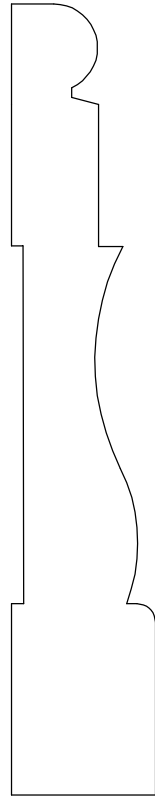

HM975

3/4" x 4 1/8"

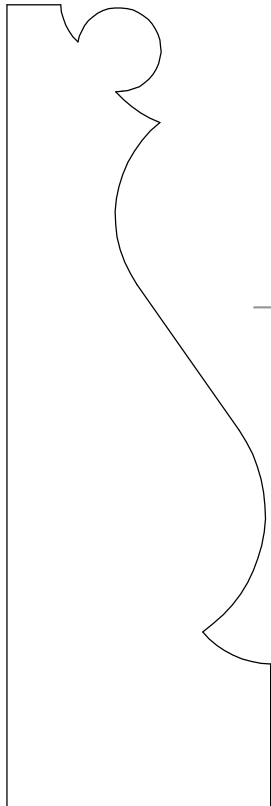

HM976

1 3/8" x 4 3/16"

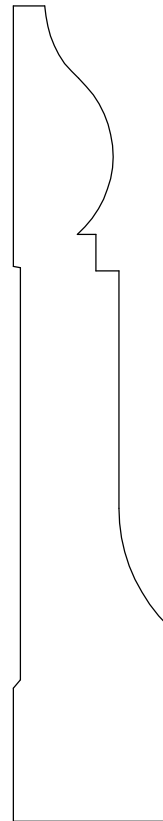

HM977

13/16" x 4 1/4"

**HURDER
MILLWORK**

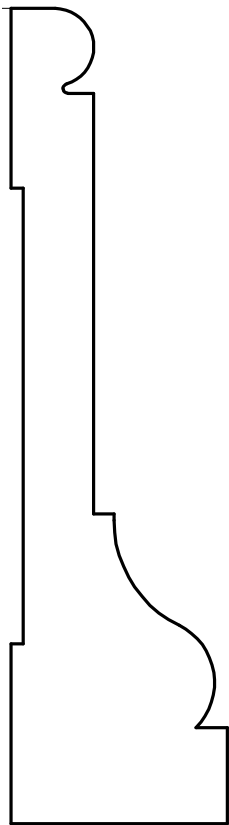

HM978

1 1/8" x 4 1/4"

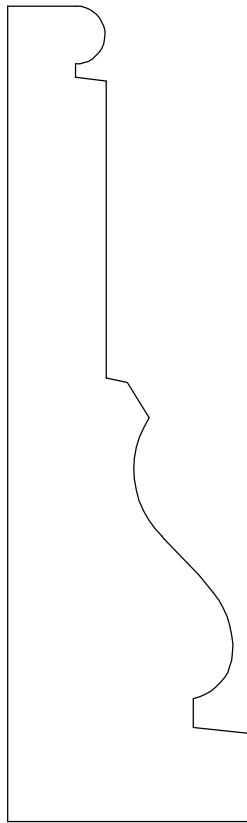

HM979

1 1/4" x 4 1/4"

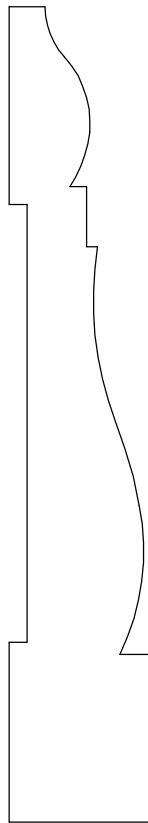

HM980

3/4" x 4 1/4"

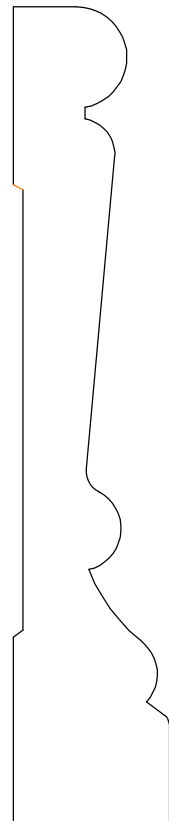

HM981

13/16" x 4 1/4"

**HURDER
MILLWORK**

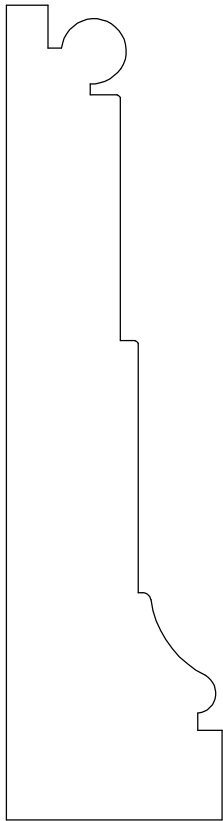

HM982

1 1/8" x 4 1/4"

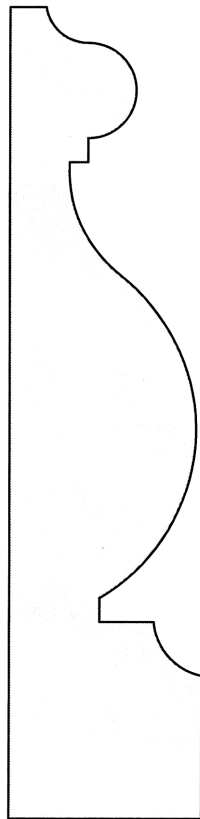

Lexington

HM983

1" x 4 1/4"

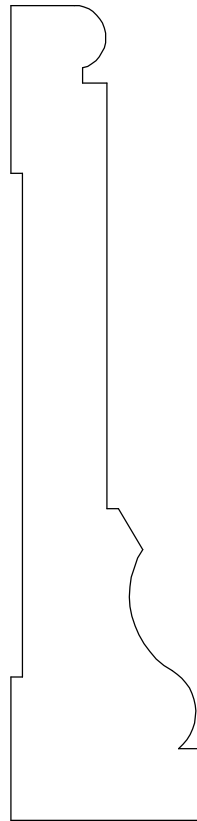

HM984

1" x 4 1/4"

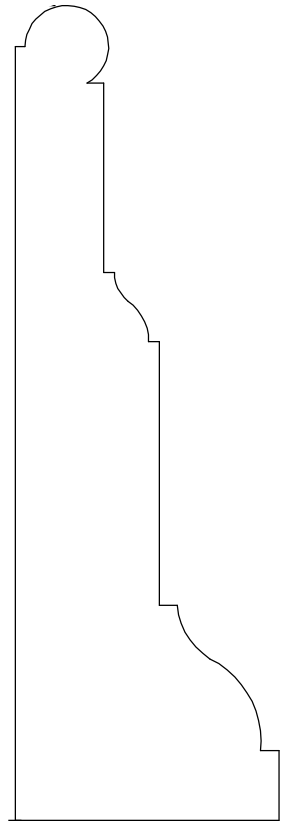

HM985

1 3/8" x 4 1/4"

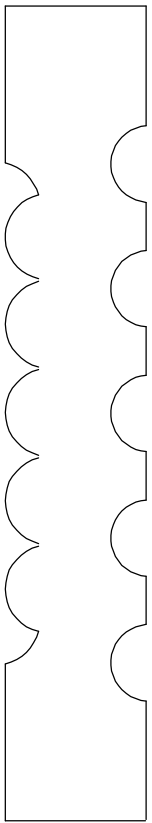

HM986

3/4" x 4 1/4"

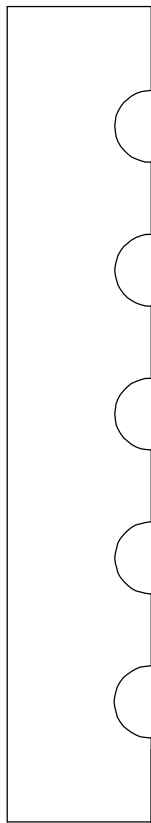

HM987

3/4" x 4 1/4"

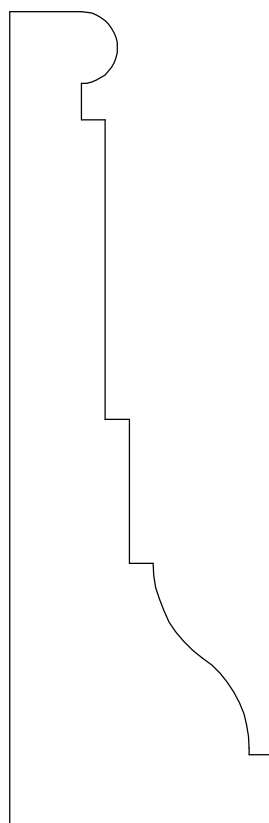

HM988

1 3/8" x 4 1/4"

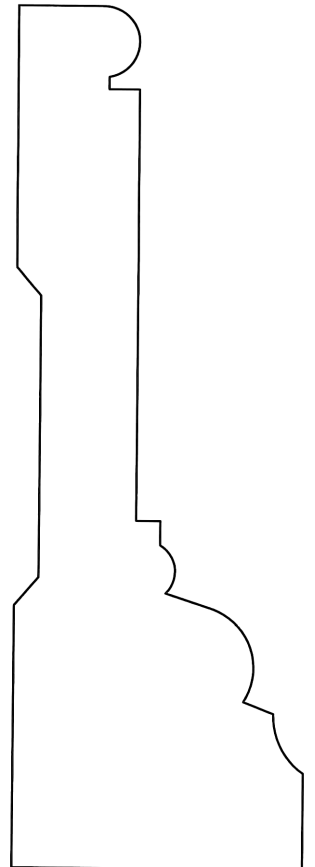

HM989

1 1/2" x 4 1/4"



HURDER MILLWORK

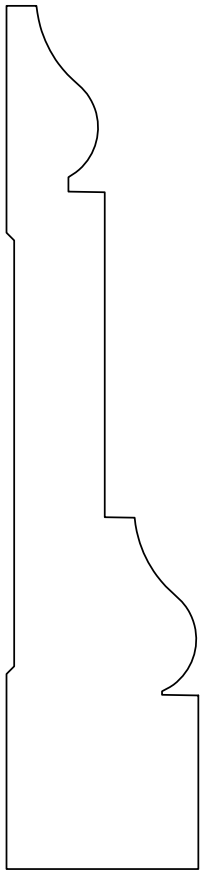

HM990

1" x 4 1/2"

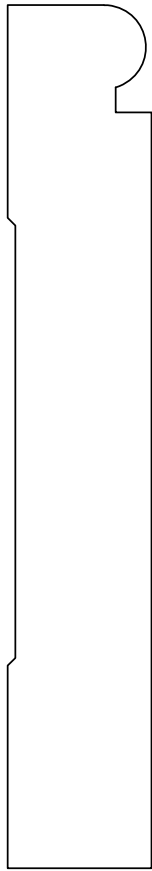

HM991

3/4" x 4 1/2"

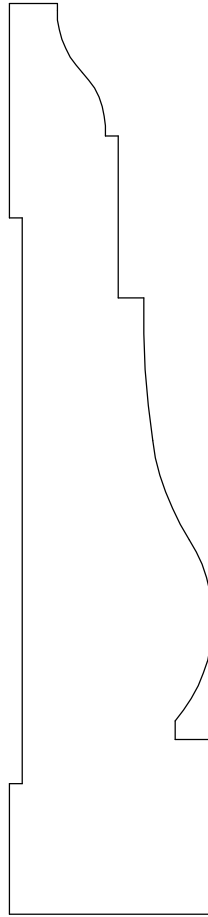

HM992

1 1/16" x 4 3/4"

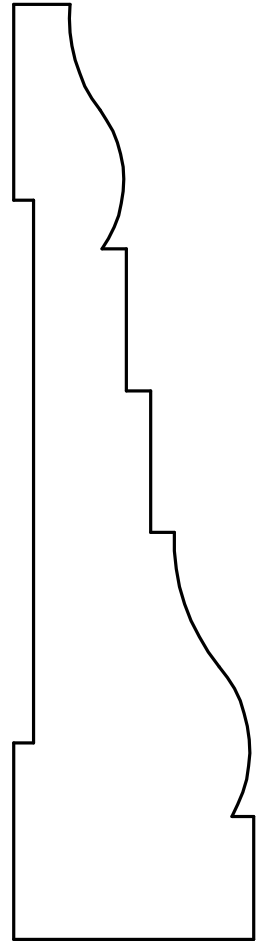

HM993

1 1/4" x 4 7/8"

HURDER MILLWORK

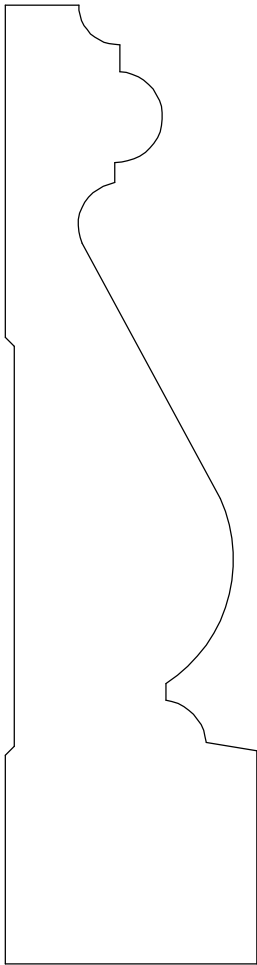

HM1000

1 15/16" x 5"

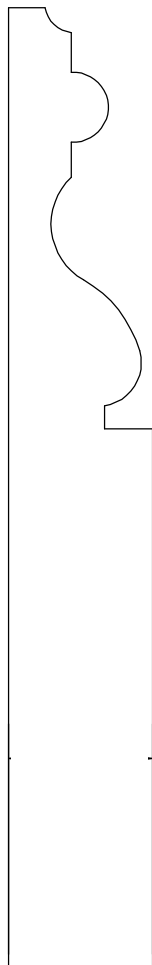

HM1001

3/4" x 5"

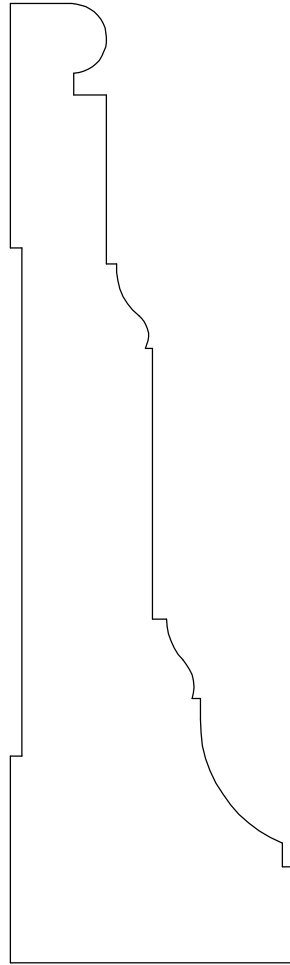

HM1002

1 3/4" x 5"

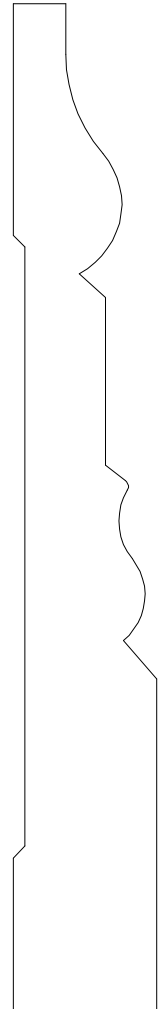

HM1003

3/4" x 5 1/4"

**HURDER
MILLWORK**

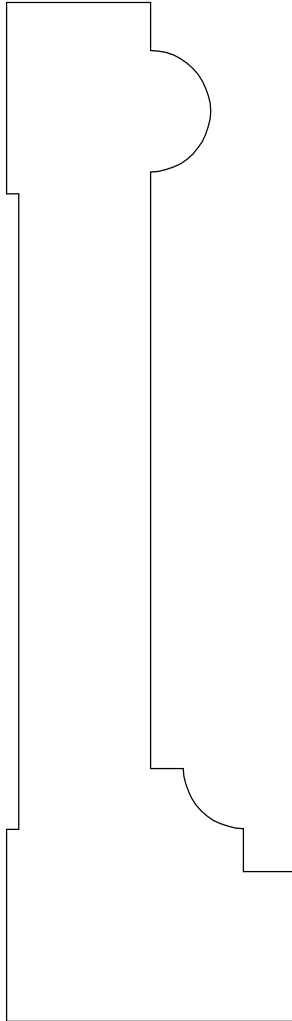

HM1004
1 1/2" x 5 5/16"

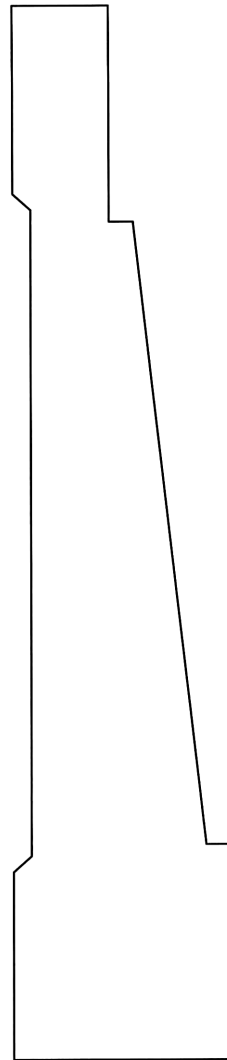

HM1005
1 1/8" x 5 1/2"



HURDER MILLWORK

www.HurderMillwork.com

**HAND RAILS
PROFILES**



HURDER MILLWORK

IN-STOCK

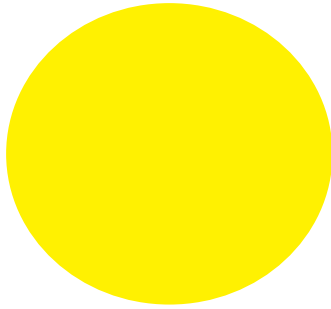

HM6010

2 1/4" x 2 3/8"

HM6010B

2 1/4" x 2 3/8"

IN-STOCK

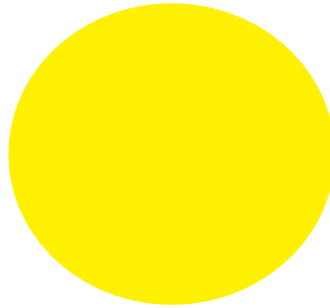

HM6210

2 5/8" x 2 3/8"

HM6210B

2 5/8" x 2 3/8"

IN-STOCK

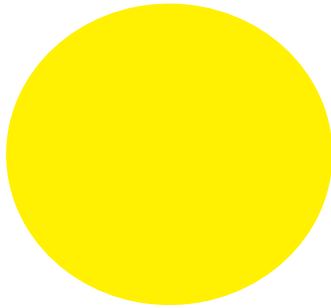

HM6510

2 5/8" x 2 3/8"

HM6510B

2 5/8" x 2 3/8"

IN-STOCK

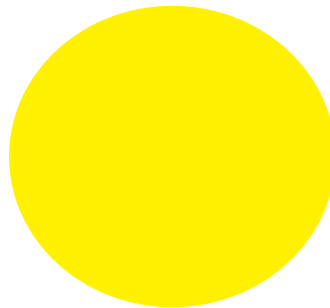

HM6710

2 3/4" x 2 3/4"

HM6710B

2 3/4" x 2 3/4"

IN-STOCK

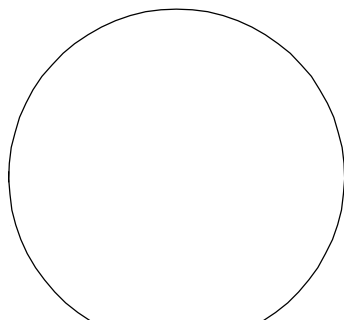

HM5100

1 5/8" x 1 3/4"

**HURDER
MILLWORK**

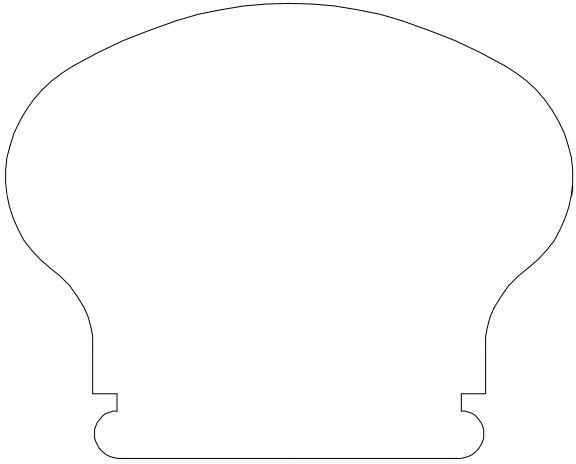

HM5101
2 3/8" x 2 31/32"

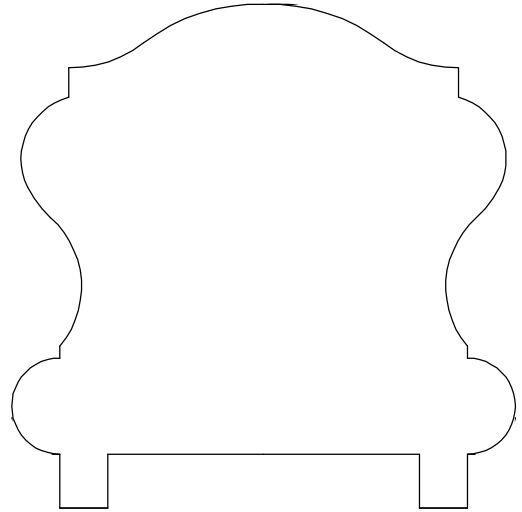

HM5102
2 5/8" x 2 5/8"

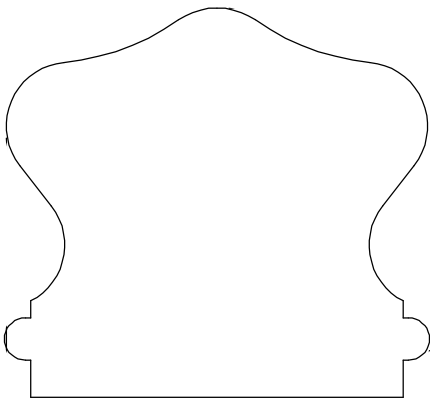

HM5103
2 1/32" x 2 7/32"

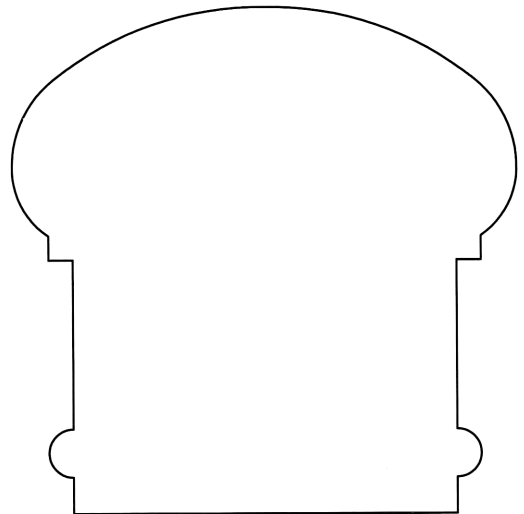

HM5104
2 5/8" x 2 5/8"

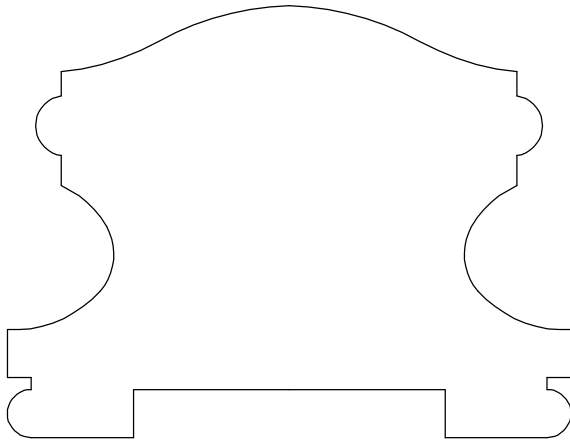

HM5105
2 1/4" x 2 15/16"

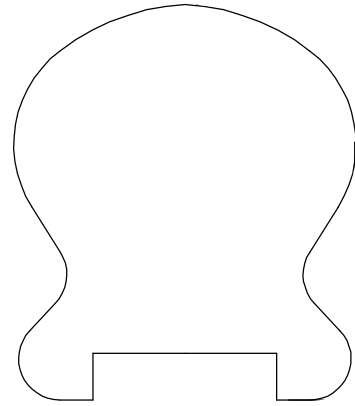

HM5106
1 13/16" x 2 1/16"

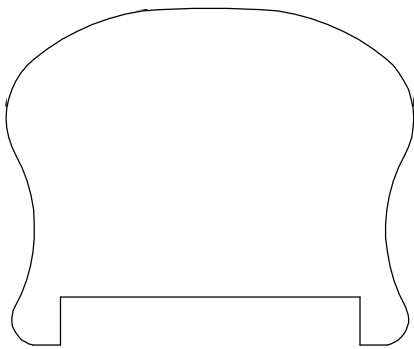

HM5107
1 3/4" x 2 1/8"

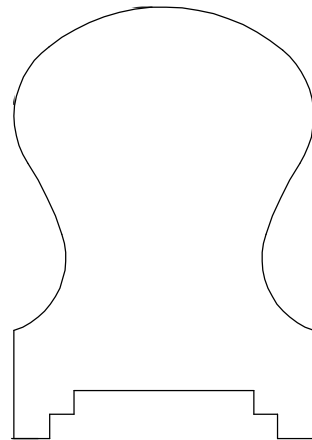

HM5108
1 9/16" x 2 1/4"

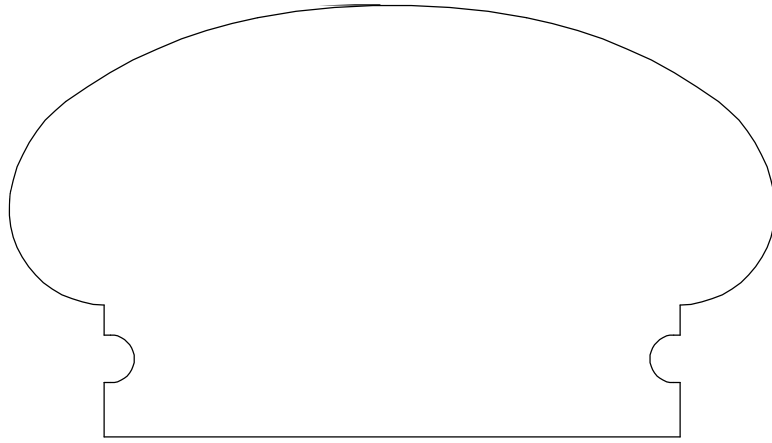

HM5109

2 1/4" x 4"

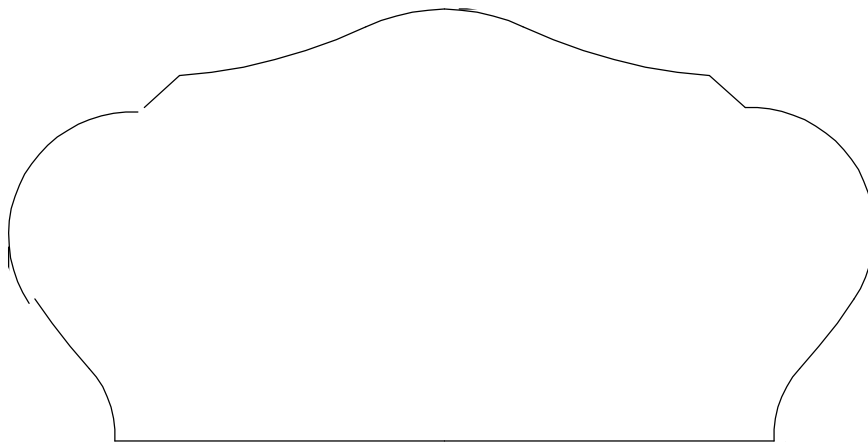

HM5110

2 1/4" x 4 1/2"

HURDER MILLWORK

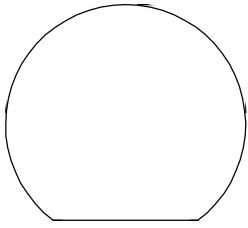

HM5111

1 1/8" x 1 1/4"

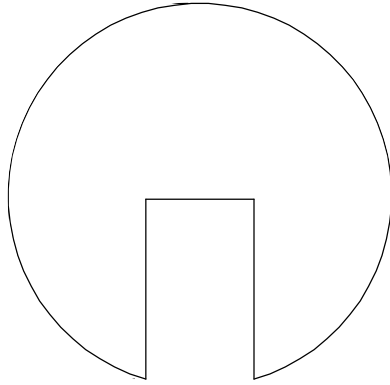

HM5112

2" x 2"

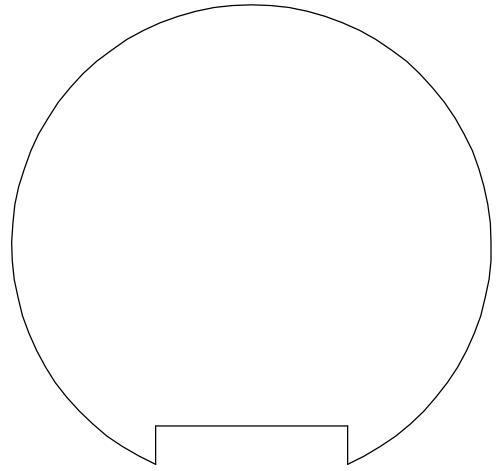

HM5113

2 3/8" x 2 1/2"

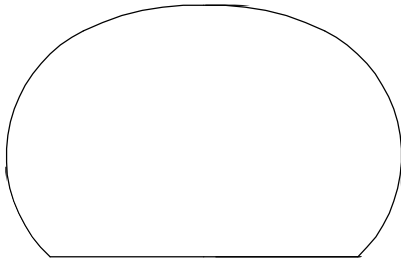

HM5114

1 5/16" x 2 1/16"

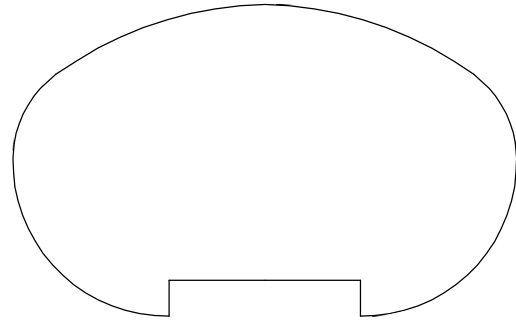

HM5115

1 5/8" x 2 5/8"

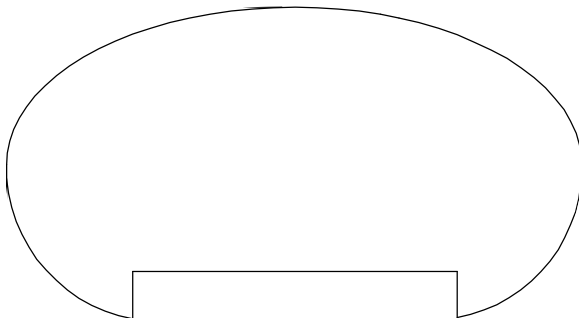

HM5116

1 5/8" x 3"

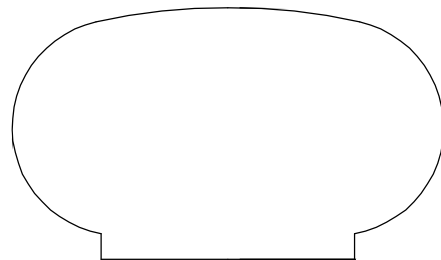

HM5117

1 5/16" x 2 1/4"

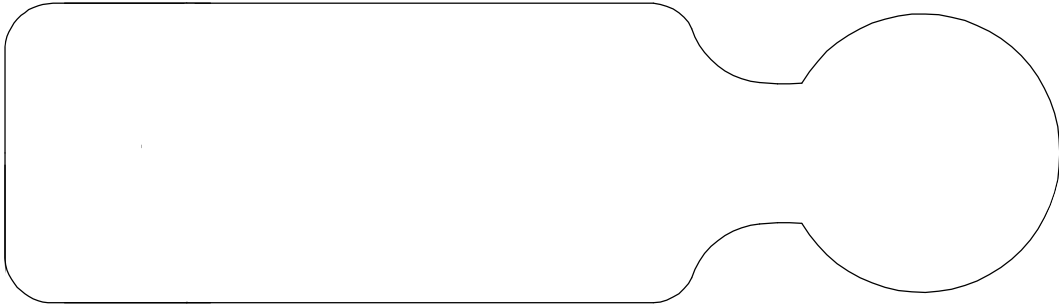

HM5118

1 9/16" x 5 1/2"

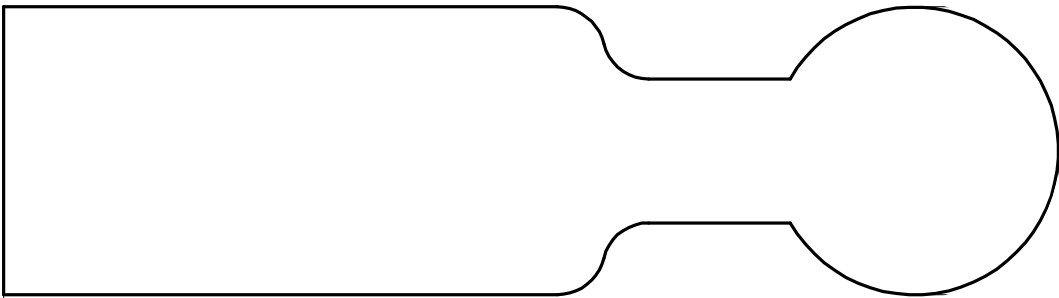

HM5119

1 1/2" x 5 1/2"

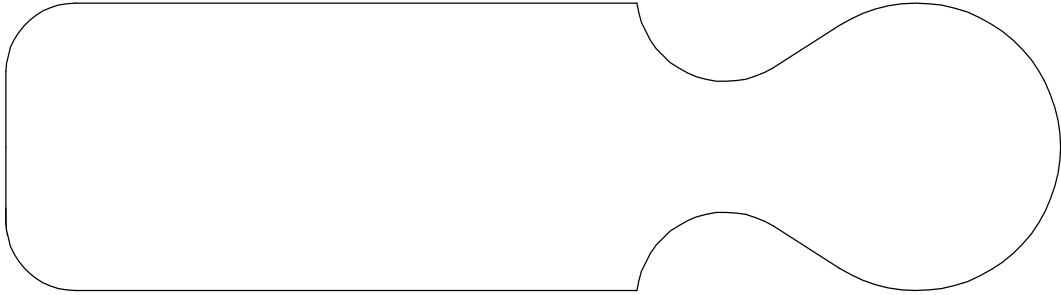

HM5120

1 1/2" x 5 1/2"

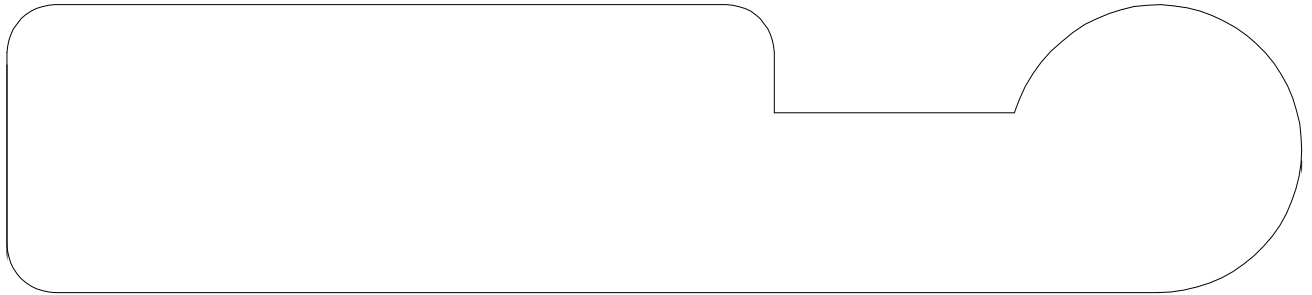

HM5121

1 1/2" x 6 3/4"



HURDER MILLWORK

www.HurderMillwork.com

INDEX OF PROFILES BY PART NUMBER



**HURDER
MILLWORK**
