

GREYSTONE®

INSTRUCTION MANUAL
Gas Range

Models:

CF-RV17/CF-RV17B/ CF-RV17BB

CF-RV21/CF-RV21B/ CF-RV21BB

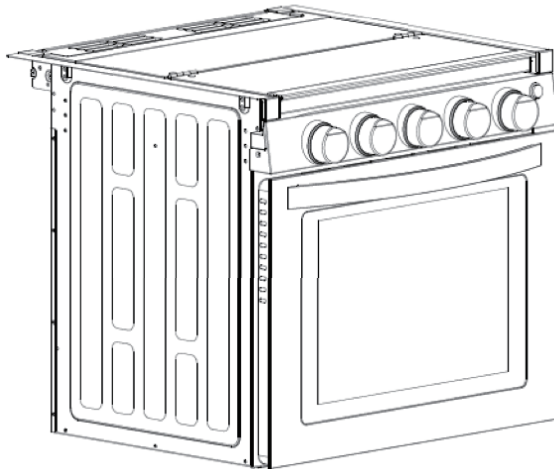

Table of Contents

Getting Started	3
Safety Precautions	4
Safety Instructions	5
Installation	10
Operation.....	15
Range Features	21
Troubleshooting	22
Cleaning and Maintenance.....	23
Exploded-View Drawing.....	24
Warranty.....	26
Contact Information	28

Getting Started

We appreciate your purchase of the GREYSTONE Gas Range for RVs. Prior to operating your new appliance, please read this manual carefully. This instruction manual contains information for safe use, installation and maintenance of the appliance.

You will want to keep this manual handy for future reference. Using the range by following the directions in this manual will help ensure safe use and reduce the risk of injury. Please pass on this manual to future owners of your range.

The manufacturer accepts no responsibility for any damage caused by not observing these instructions.

Safety Precautions

WARNING

Warning: If the instructions in this manual are not followed exactly, a fire or explosion may result causing property damage, personal injury or death.

Do not store or use gasoline or other flammable vapors or liquids near this or any appliance.

WHAT TO DO IF YOU SMELL GAS:

- Do not try to light any appliance
- Do not touch any electrical switch
- Do not use any phone in your recreational vehicle
- Clear the recreational vehicle of all occupants
- Turn off the gas supply tank valve(s) or main gas supply
- From a location away from the gas smell, Immediately call your gas supplier for instructions
- If you cannot reach your gas supplier, call the fire department
- Have the gas system checked and leakage source corrected by a qualified installer, service agency, manufacturer or dealer of the gas supplier.

 is the safety alert symbol. This symbol alerts you to potential hazards that can result in property damage and/or serious bodily harm or death. All safety messages will follow the safety alert symbol and either the word **WARNING** or **CAUTION**. These words mean:

WARNING

Warning: Hazards or unsafe practices **COULD** result in severe personal injury or death.

Caution

Caution: Hazards or unsafe practices COULD result in minor personal injury

Read the follow all instructions before using this application to prevent the potential risk of fire, electric shock, personal injury or damage to the appliance as a result of improper usage of the appliance. Use appliance only for its intended purpose as described in this guide.

If an external electrical source is utilized, the appliance must be electrically grounded in accordance with state or other codes or, in the absence of such codes, with the National Electrical Code (ANSI /NFPA 70). Do not attempt to adjust, repair, service, or replace any part of your appliance unless it is specifically recommended in this guide. Other services should be referred to a qualified service technician.

Warning and important safety instructions appearing in this guide are not meant to cover all possible conditions and situations that may occur. Common sense, caution, and care must be exercised when installing, maintaining, or operating the appliance. Always contact the manufacturer about problems or conditions you do not understand.

Safety Instructions

To reduce risk of tipping of the appliance from abnormal usage or by excessive loading of the oven door.

- **Remove all tape and packaging before using the range.**
Destroy the carton and plastic bag after unpacking the range.
Never allow children to play with packaging material.

- **Your appliance should be installed by a qualified technician in accordance with state and local laws.**
- **Never modify or alter the construction of a range by removing leveling legs, panels, anti-tip brackets/screws, or any other part of product.**

Do not use the oven or warmer drawer (if equipped) for storage.

Do not store items of interest to children in the cabinets above a range. Children climbing on the range to reach items could be seriously injured.

WARNING

NEVER use this appliance as a space heater to warm a room. Doing so may result in carbon monoxide poisoning and overheating the oven.

NEVER cover rear vent on counter top, internal cavity holes or space at bottom of oven door. Never cover an entire rack with materials such as aluminum foil or any other flammable items. Doing so blocks air flow through the oven and may cause carbon monoxide poisoning, explode, or start a fire.

- The appliance must be disconnected from the gas supply piping system during any pressure testing of that system at test pressures in excess of 1/2 psi(3.5 kPa).
- The appliance must be isolated from the gas supply piping system during any pressure testing of the gas supply piping system at test pressures equal to or less than 1/2 psi(3.5 kPa)
- **DO NOT TOUCH SURFACE BURNERS, AREAS NEAR THESE BURNERS, OVEN BURNERS, OR INTERIOR SURFACES OF THE OVEN OR WARMER DRAWERS (if equipped).**

During and after use, do not touch or let clothing or other flammable items touch these areas until they have sufficient time to cool down. Both surface burners and oven burners and oven vent (if equipped) may be hot even though flames are not visible and may be hot enough to cause burns.

- Wear proper apparel: Loose fitting or hanging clothing should never be worn while using this appliance.
- When heating fat or grease, watch it closely. Fat and grease may catch fire if allowed to become too hot. If there is a grease fire, smother the fire with a pan lid, use baking soda, or a dry chemical or foam-type extinguisher. **DO NOT USE WATER OR FLOUR.**
- The recess in which an oven is to be installed shall be constructed so as to be framed in or guarded to prevent creation or storage space around the recessed portion of the appliance.

WARNING

Gas leaks may occur in your system and result in a dangerous situation. Gas leaks may not be detected by smell alone. Gas suppliers recommend you purchase and install an UL approved gas detectors. Install and use in accordance with the manufacturer's instructions.

Use only dry potholders and do not let potholders touch hot heating burners. Do not use a towel or other bulky doth or towels in place of potholders.

Never heat unopened food containers as the buildup of heat and pressure may cause container to explode and result in injury.

If you will be storing the range or throwing it away, remove the oven door beforehand.

IMPORTANT: Do not attempt to operate the appliance during a power failure. If the power fails, always turn off the oven because the oven may begin to operate again when power resumes, even if nobody is present. Once power is restored reset clock.

Instructions for using your cooktop

- Using proper flame size: adjust flame so it does not extend beyond the edge of utensils. Undersized utensils will expose a portion of the burner flame to direct contact and may result in ignition of clothes. Proper utensil and flame size will improve efficiency. Burners are different sizes for different utensil sizes. The furniture above hobs has the potential risk during hobs working.
- If you use stove top grill on a sealed gas burner, it will cause incomplete combustion and can result in carbon monoxide poisoning.
- Know which knob controls each surface burner. Place a pan of food on the burner before turning it on, and turn the burner off before removing pan.
- Always turn the knob to the full LIGHT position when igniting top burners and visually check that burner is lit.
- Then adjust the flame so it does not extend beyond the edge of the utensil.
- Utensil handles should be turned outward and not extend over adjacent surface burners. This will help reduce the risk of burns, ignition of flammable materials, and spillage due to unintentional contact with the utensil.
- **Never leave surface burners unattended at high heat settings:** Boil overs cause smoking and greasy spillovers that may ignite.

- **Protective liners:** Do not use aluminum foil to line surface burner pans or oven bottom, except as suggested in this manual. Improper installation of these liners may result in risk of electric shock or fire.
- **Do not use searing grill on the cooktop.** Searing grills are not designed for use on the cooktop. Doing so may result in a fire.
- **Do not use decorative surface burner covers.** If burner is accidentally turned on, covers will become hot and possibly melt. There may be damage to the cooktop due to overheating and can lead to combustion problems.
- **Glazed cooking utensils:** Only certain types of glass, glass/ceramic, or other glazed utensils are suitable for range top use. Avoid use of glazed utensils whenever possible.

Important Instructions for Using your Oven

- **Be careful when opening oven door of a hot range or warmer drawer (if equipped).** When opening door to a warm or hot oven, stand to the side rather than directly in front of the range. . Allow hot air or steam to escape before you remove or replace food in the oven/warmer drawer.
- **Keep oven vent ducts unobstructed.** Oven vent is located at the center rear of the cooktop. Touching the surfaces in this area when the oven is on or still hot may cause severe burns.
- **Always place oven racks in desired location while oven/warmer drawer (if equipped) is cool.** If rack must be moved while oven is hot, use extreme caution. Use potholders and grasp the rack with both hands to reposition. Do not let potholders contact the hot heating elements in the oven/warmer drawer (if equipped). Remove all utensils from the rack before moving.

- **Do not use a broiler pan without the insert.** The broiler pan and insert allow dripping fat to drain and be kept away from the broiler.
- **Do not use aluminum foil to cover your broiler insert.** Exposed fat and grease could ignite.
- **Do not touch heating elements or interior surfaces of oven:** Heating elements may be hot even though they are dark in color and may cause burns. This Oven is intended to be built-in to a cabinet structure only and is not intended for attachment to the building structure.
- **Do not touch any place on the vent panel(Located at the back of the product).** The panel would be hot during oven cooking and may cause injury.

Cleaning Instructions

Clean your range regularly to keep all parts free of grease that could catch fire. Exhaust fan ventilation hoods and grease filters should be kept clean. Do not allow grease to accumulate on hood or filter as greasy deposits in the fan could ignite. When you are cooking food under the hood, turn the fan on.

Installation

The installation must conform with state or other codes or, in the absence of such codes and the standard for Recreational Vehicles (ANSI /NFPA 1192).

WARNING

Installation of this appliance must adhere to the written instructions in this manual. No agent, representative or employee of the manufacturer of GREYSTONE appliances or

other person has the authority to change, modify or waive any provision of the instructions this manual.

Cabinet Cutout Instructions

To ensure proper operation of your range, suitable cabinets must be used, and cabinets must be leveled, with the bottom of the range supported.

Notes:

- There must be a ventilation hole in the cabinet for air circulation. A gap at the bottom of the oven a minimum of 3/8" will also provide air circulation.
- The minimum vertical distance from the cooking top is 30". Using non-combustible materials and construction can reduce distance.
- The maximum depth of cabinets installed above the cooking top is 13". If there is range hood below the cabinet, there is no limit for the depth of the cabinet.
- The minimum distance between the vehicle/trailer floor and bottom of cutout is 4". The minimum distance to the bottom of range hood is 19.5".
- The minimum horizontal distance(s) for sides and back of the range to adjacent vertical combustible walls extending above the top panel:
 - 7.25" from the side walls
 - 9" from the rear wall

These distances are measured from the center of the burner,

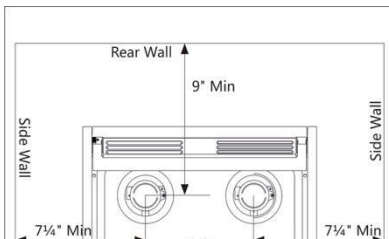

Cabinet and counter cutout:

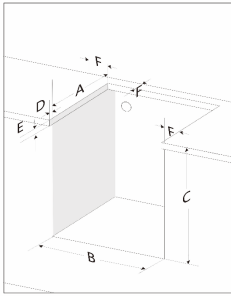

Model	A	B	C	D	E	F
17" RV Range	17 ³ / ₄ " 451mm	20 ¹ / ₄ " 514mm	16 ¹ / ₈ " 410mm	15/16" 23mm max.	19/16" 40mm max.	2" min 51mm min.
21" RV Range	17 ³ / ₄ " 451mm	20 ¹ / ₄ " 514mm	20 ¹ / ₁₆ " 510mm	15/16" 23mm max.	19/16" 40mm max.	2" min 51mm min.

Oven installation

Once the cabinet has been prepared according to the dimensions provided and once the gas line is in place:

1. Remove packing material, tape and any temporary labels from your range, Unscrew the two screws marked on Fig.1-1.

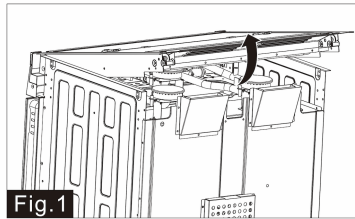
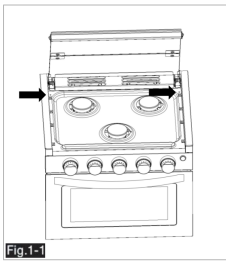

2. Push back the top glass cover assembly a little and lift up to remove it from the range oven. (Fig. 2)

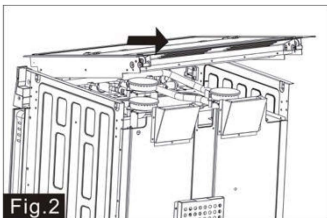

3. Slide the range oven into the cabinet opening. Verify the oven is level from side to side and front to rear. (Fig. 3)

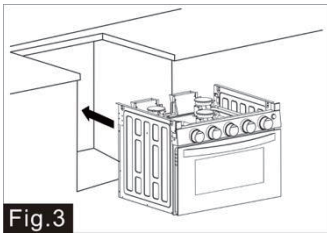

4. Connect a copper gas supply line to the range oven through gas cavity on the upper Left-rear corner of the cabinet. Connect a 12V power supply wire to the appliance from the upper right-rear corner of the cabinet. (Fig. 4)

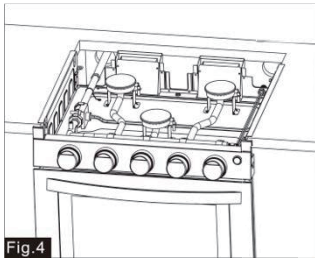

5. Use two tapping screws on both left and right to secure the range oven (Fig. 5)

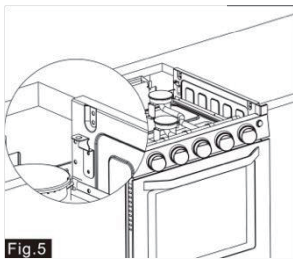

- 6 & 7. Check the pipe fittings for leaks using a soapy solution. Never use a flame. Push to insert the top glass cover assembly

into the metal dip and place it into the range oven, then pull front a little to lock into place. (Fig. 6 & Fig. 7)

Tighten the screws marked on the picture Fig.1 –1.

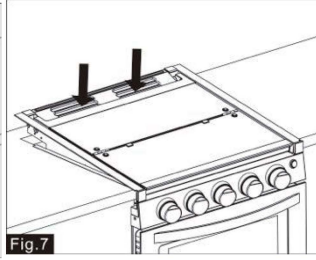
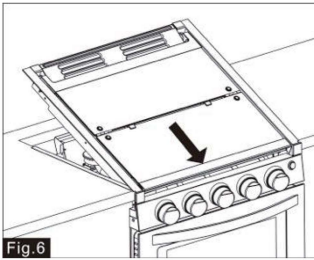

8. The range oven is completely installed into the cabinet. (Fig. 8)

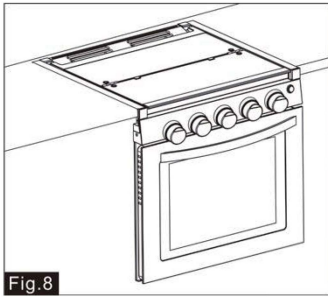

Model without LED light:

Connect the wires of oven and lamp to a 12V DC circuit with a fuse protected and a max rating of no more than 15 amps.

Note: Make sure to connect the wires with the correct polarity.

Black is + and white is –

Electrical Connection

Model with LED light: Connect the light wires to a 12V DC circuit with a fuse protected and a max rating of no more than 15 amps.

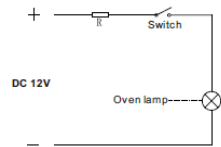

Wiring Diagram

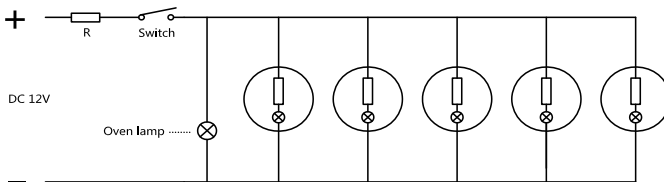

Wiring Diagram

Operation

Lighting Oven

Match Lighting:

1. Before lighting, check to make sure all the control knobs are turned to **OFF** position.
2. Make sure the main gas tank valve is open.
3. Open the range door (Fig. 13)

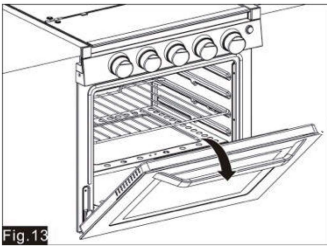

4. Push and rotate the oven control knob counterclockwise to "🔥" position. (Fig 14)

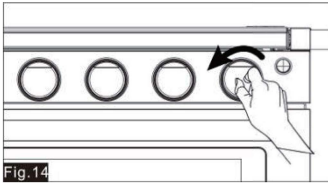

5. Continue to push and hold in the oven control knob, then open the oven door and insert a lit, long wooden match or a butane lighter with extension) through the spaces in the grate near the ports of the burner to light the oven burner. (Fig. 15)

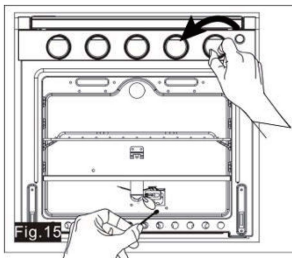

6. Continue to push and hold in the oven control knob for 5 seconds after pilot is lit. Repeat steps 4 and 5 if not lit.
7. Rotate the oven control knob to adjust burner flame to desired Level. (Fig. 16)

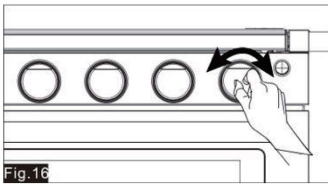

Electronic Ignition:

1. Before lighting, check to make sure all the control knobs are turned to OFF position.
2. Make sure the main gas tank valve is open.
3. Push and turn the oven control knob counterclockwise to "  " position. (Fig. 14)
4. Continue to push and hold in the oven control knob for 5 seconds and rotate the ignition button clockwise repeatedly until burner lights. Repeat steps 3 & 4 if not lit. (Fig. 17)

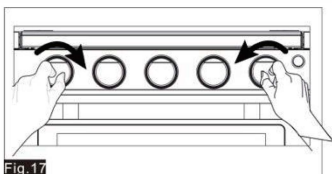

5. Rotate the oven control knob to adjust pilot flame to desired Level. The oven pilot has been factory set and requires no further adjustment.

Lighting Top Burners

WARNING

Top cover must be open when main burner is in operation. Based on safety considerations, the top burner flame size should be adjusted so it does not extend beyond the edge of the cooking utensil.

Match Lighting:

1. Before lighting, check to make sure the control knobs are turned to OFF position
2. Make sure the main gas tank valve is open
3. Turn the appropriate burner knob counterclockwise to "HI" position. (Fig. 9)

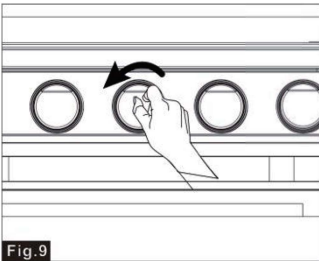

4. IMMEDIATELY strike and place a lit, long wooden match or a butane Lighter with extension) through the spaces in the grate

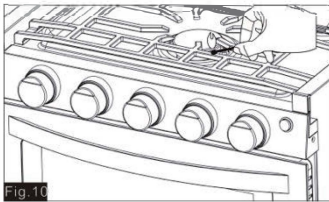

near the ports of the burner to light the burner. Repeat steps 3 & 4 to light all burners (Fig. 10)

5. Push and turn the burner

control knob to adjust the flame level. (Fig 11)

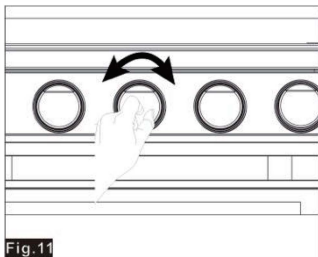

Electronic Ignition:

1. Before lighting, make sure the control knobs are turned to **OFF** position.
2. Make sure that the main gas tank valve is open.
3. Rotate the appropriate burner knob counterclockwise to "HI" position. (Fig. 9)

NOTE: Do not attempt to light more than one burner at a time.
4. Turn the ignition knob clockwise repeatedly until burner Lights. (Fig. 12)

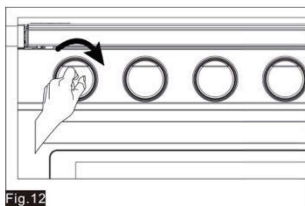

To Turn Off:

To extinguish the oven or top burner flame, push and turn the oven control knob clockwise to OFF position. Always turn off the gas tank valve when refueling or traveling.

The Burner Flame: Keep your arms and face away from above the cooking area. Flames should appear similar to the good flame

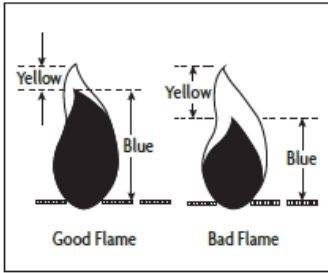

A good flame should be blue with a yellow tip. Some yellow tips on flames up to 1 inch in length are acceptable as long as no carbon or soot deposits appear. If flames are excessively yellow and

irregular, the oil residue may not be completely burned off, or the Venturi may be clogged or may not be properly positioned over the holes. Allow the appliance to cool before repositioning the Venturi over the valve and holes.

LED Light 

Press the button to manually turn the oven light on/off.

Leak Check:

Always perform a leak test for possible leaks according to the manufacturer's instructions before any operation. Pressure/Leak test using 11-13.8 WC pressure.

WARNING

Extinguish all open flames. NEVER Leak test when smoking. Do not use the oven until connection has been leak tested and does not leak.

1. Make sure all control knobs are turned to OFF position.
2. Apply a gas leak detection liquid such as soapy water to the connections.
3. Gas leaks will be detected with the presence of bubbles.

4. To stop the leak, tighten the loose joint, or replace the faulty part with a replacement part recommended by dealer.

WARNING

PRODUCT DAMAGE HAZARD

DO NOT cook with the control knob set in the LIGHT position. Damage to the ignition module and burner electrodes may result.

DO NOT use oversized cookware. The pan should not be more than one inch larger than the burner grate. The maximum pan size is a 10-inch skillet. Oversized cookware will cause excessive heat build-up in the appliance top and will result in damage to the burner grate, burner and cooktop.

DO NOT use a broiler pan, griddle, or any other large utensil which covers more than one top burner at a time. This will create excessive heat which may cause melting, sooting or discoloration damage to the burner grates, range top, or utensils.

DO NOT leave an empty utensil, or one which has boiled dry, on a hot top burner. The utensil could overheat and damage the utensil or the cooking appliance.

Cooking Tip

For best results, preheat oven for 15 minutes before placing food inside.

Range Features

Optional Power	Gas power
BTU/HR	Left and Right Burner: 6500BTU
	Front Burner: 8000BTU
	Oven: 7100BTU
Fuel/Power	Propane
Inlet Pressure	10" WC Min to 13.8" WC Max
Power Input	12V DC<2 Amp
Inner Volume of the Oven	17" Range Oven:35L
	21" Range Oven:51L

1	Glass Cover
2	Grill
3	Ignition Knob
4	Oven Door
5	Top Burner Control Knob
6	Oven Control Knob
7	Backlight
8	Burner

This appliance conforms to the directive:

ANSI Z21.57-2010 Recreational Vehicle Cooking Gas Appliances

ANSI Z21.57a-2012 Addenda to Recreational Vehicle Cooking Gas Appliances

CAN1-1.16-M79 (reaffirmed 2016) Propane Cooking Appliance For Recreational Vehicles

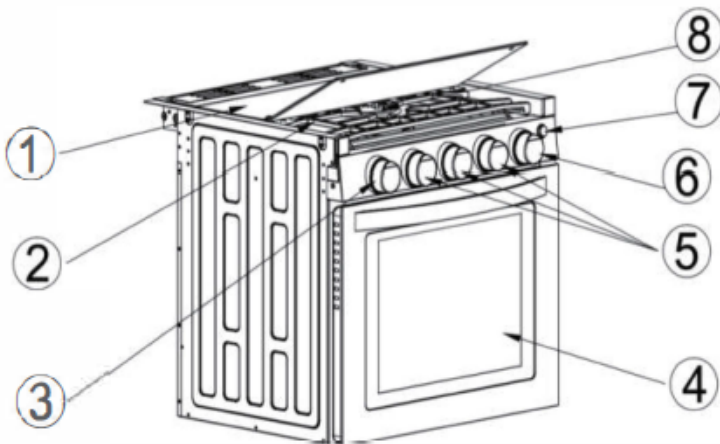

Troubleshooting

PROBLEM/SYMPTOM	POSSIBLE CAUSE/SOLUTION
Surface burners do not light or do not burn evenly	Surface control knob has not been fully rotated to the LIGHT position.
	Check to see if gas valve is open. If not, open it.
	Burners are clogged. Make sure burner is off. Use a small wire, toothbrush or needle to clean burner ports and slots.
	Low gas level in tank. Refill or replace gas tank.
	Low battery power. Replace AAA battery which is under igniter cap.
	There is moisture on the burner. With burner off, dry burner completely.
Surface burner flame is yellow or orange instead of blue	Debris may be present in gas line. Let burner run for a few minutes to see if flame changes to blue.
	Humid air in the home, sometimes caused by running a humidifier, may cause flames to be burn yellow.

Cleaning and Maintenance

- Make sure all controls are OFF and the range or cooktop is cool before cleaning.
- DO NOT use oven cleaners, bleach, steel wool or rust removers on the cooktop or burner grates. Only use nonabrasive pads.
- DO NOT obstruct the flow of combustion and ventilation air.
- Keep appliance area clear of combustible materials, gasoline and other flammable vapors and Liquids.
- Clean oven with oven cleaner only. Never use a wire brush or metallic item for cleaning burner ports or orifices. Brush may "shed" bristles that may lodge in the orifice or burner ports and cause a fire or explosion.
- Use warm soapy water only to clean the burner grates, cooktops, painted surfaces, porcelain surfaces, stainless steel surfaces and plastic items on your range or cooktop. Do not use gritty or acid-type cleaners.
- DO NOT allow foods containing acids (such as lemon or tomato juice, or vinegar) to remain on porcelain or painted surfaces. Acids may remove the glossy finish. Wipe up egg spills when cooktop is cool.
- DO NOT wash warm porcelain surfaces. Allow these areas to cool before cleaning. You could burn yourself, or the porcelain could crack.
- Pitting and discoloration will result if spills are allowed to remain for any length of time on stainless steel.
- DO NOT allow spillovers to remain on the burner caps. The caps could become permanently stained.
- When cleaning around the burners, use care to prevent damage to the electrode (if so equipped). If a sponge or cloth should catch the metal igniter electrode, it could damage or break the electrode. If this occurs, the burner will not light.

Exploded-view Drawing

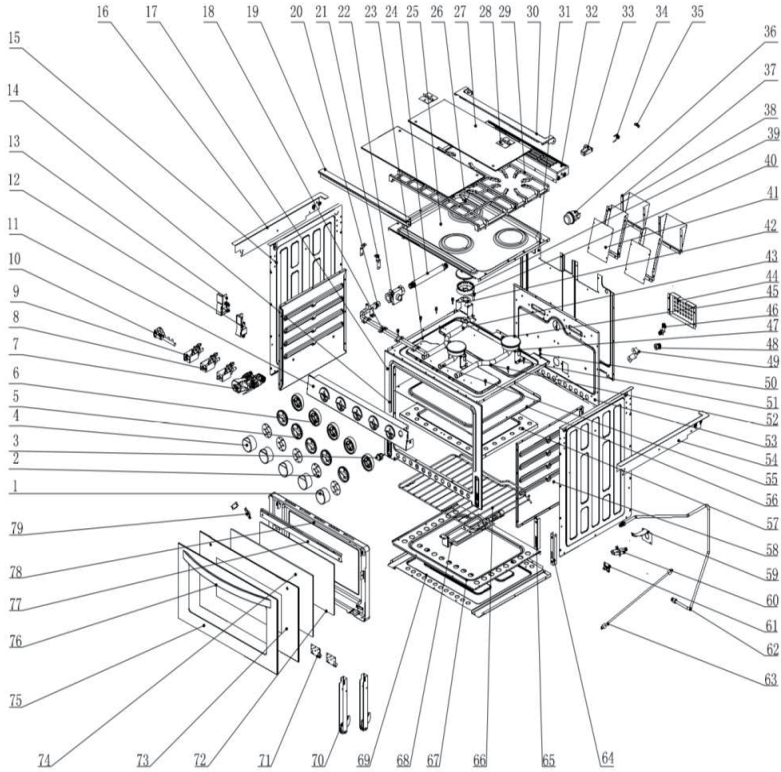

1	Knob
2	LED PCB
3	Lamp Switch
4	Igniter Knob
5	Decoration Ring
6	Knob Base
7	Oven Thermostat
8	Front Burner Valve
9	Rear Burner Valve
10	Igniter
11	Control Panel
12	Control Panel Holder (Right)
13	Control Panel Holder (Left)
14	Door Silicon Sealing Ring
15	Side Cover
16	Left Hob Table Plate
17	Front Cavity Plate
18	Gas-in Pipe Holder
19	Glass Cover Fixer (Front)
20	Front Gas-in Pipe
21	Hob Table Fixer
22	Regulator
23	Insulation Plate
24	Rear Gas-in Pipe
25	Hob Table
26	Front Pan Support Grill
27	Glass Cover
28	Glass Cover Hinge
29	Rear Pan Support Grill
30	Glass Cover Holder (Rear)

31	Rear Cover
32	Chimney Decoration Panel
33	Glass Cover Spring Holder
34	Glass Cover Spring
35	Nut
36	Viewing Lamp
37	Chimney Holder
38	Chimney Cover
39	Fire Distributor
40	Front Burner Ignition Pin
41	Chimney Cover (Bottom)
42	Mica Sheet
43	Left Burner Pipe
44	Gas-in Connector Cover
45	Burner Cover
46	Nozzle Base
47	Rear Burner Ignition Pin
48	Oven Burner Nozzle
49	Nozzle Base Holder
50	Grill Silicon Gasket
51	Burner Holder
52	Right Burner Pipe
53	Rear Cavity Plate
54	Right Hob Table Plate
55	Front Burner Pipe
56	Up Cavity Plate
57	Oven Burner Baffle Plate
58	Side Cavity Plate
59	ODS Holder
60	ODS
61	Temp Control Holder

62	Oven AL Pipe
63	Oven Burner Pipe
64	Door Hinge Holder(Right)
65	Door Hinge Holder(Left)
66	Bake Rack
67	Bottom Cavity Plate
68	Oven Burner
69	Bottom Cover
70	Door Hinger
71	Door Glass Holder
72	Door Inner Glass
73	Door Outer Glass
74	Door Middle Glass
75	Door Outer Frame
76	Door Handle
77	Door Inner Frame Holder
78	Door Inner Frame
79	Door Middle Glass Holder

Warranty

Your GREYSTONE appliance is covered by a one-year limited warranty. For one year from your original date of purchase of the original purchaser, GREYSTONE will pay costs for repairing or replacing any parts of this appliance that prove to be defective in materials or workmanship when such appliance is installed, using and maintained in accordance with the provided instructions.

Exclusions

This warranty does not cover the following:

1. Products on which original serial numbers have been removed, altered or cannot be readily determined.
2. Product that has been transferred from its original owner to another party or removed outside that USA or Canada.
3. Rust on the interior or exterior of the unit.
4. Products purchased secondhand.
5. Products used commercially.
6. Service calls which do not involve malfunction or defects in materials or workmanship, or for appliances not in ordinary household use or used other than in accordance with the provided instructions
7. Service calls to correct the installation of your appliance or to instruct you how to use your appliance.
8. Expenses for making the appliance accessible for servicing, such as removal of trim, cupboards, shelves, etc., which are not a part of the appliance when it is shipped from the factory.
9. Service calls to repair knobs, buttons, handles, or other cosmetic parts.
10. Surcharges including, but not limited to, any after hour, weekend, or holiday service calls, tolls, ferry trip charges, or

mileage expense for services calls to remote areas, including the state of Alaska.

11. Damage to the finish of appliance, RV, or home incurred during installation, including but not limited to floors, cabinets, walls, etc.
12. Damage caused by services performed by unauthorized service companies, use of parts other than genuine GREYSTONE parts or parts obtained from persons other than authorized service companies, or external causes such as abuse, misuse, inadequate power supply, accidents, fires, or acts of God.

The customer's sole or exclusive remedy under this limited warranty shall be product or repair or replacement as provided herein. Claims based on implied warranties, including warranties of merchantability or fitness for particular purpose, are limited to one year or the shortest period allowed by law, but not less than one year. GREYSTONE shall **not be liable** for consequential or incidental damages such as property damage and incidental expenses resulting from **any breach of this written** limited warranty or any implied warranties, so these limitations or exclusions may not apply to you. **This written warranty** gives you specific legal rights. You may also have other rights that vary from state to state.

Keep your receipt to establish the warranty period should service be required. If service is performed, please obtain and keep all receipts. Product features or specifications as described or illustrated are subject to change without notice.

GREYSTONE



WAY

Interglobal Network

For further information, please contact:

Way Interglobal Network, LLC
3002 Coast Ct
Elkhart IN 46514

(574) 971-4490

Hours: Monday- Friday
7:30 a.m. -4 p.m. Eastern Time
Closed Saturday- Sunday

GREYSTONE is a registered Trademark of Way Interglobal Network, LLC
