

ULTRA LED RT5/6 and RT6 Gimbal

Recessed Downlight Kit



The SYLVANIA ULTRA RT5/6 is a 5" and 6" compatible LED recessed downlight kit creating high performing white light and is optimized for new construction and retrofit applications. Installation is done quickly and easily in most standard 5" or 6" Insulated Ceiling (IC) housings, Airtight (AT) housings and non-IC housings. The adjustable gimbal features a smooth travel from nadir to a 30° tilt, making it suitable for slanted ceilings and wall wash. The gimbal's friction blade design allows the downlight to be installed in any position within the housing aperture and the 360° horizontal rotation capability of the gimbal head offers easy aiming and adjustment.

Dimming

The SYLVANIA ULTRA RT Series recessed downlight kits are dimmable down to 10% of full light output with compatible dimmers. The minimum dimming value is based on light output using compatible dimmers, and may not be an indication of the kit's full rated capability. In some cases, standard incandescent dimmers require a minimum load of typically >40 watts on the circuit for full range dimming performance (four LED modules). For dimming with digital (smart) multi-location dimmers or when dimming fewer than four LED modules, electronic low-voltage (ELV) dimmers are required (some ELV dimmers need a neutral connection in the wallbox).

Application Information

Applications

- Healthcare
- Hospitality
- Office
- Property Management
- Residential
- Retail

Key Features & Benefits

- Lumen package:
 - 700 lumens
 - 900 lumens
 - 1200 lumens
- Replacement for up to 100W incandescent lamps
- RT5/6 fits into most 5" and 6" recessed downlight fixtures
- CCT: 2700K/3000K/4000K/5000K
- CRI: 90 and >80 CRI option
- Beam angle: 80°
- Dimmable down to 10%* of full light output with compatible dimmers
- 50,000 hour life (L₇₀)
- Suitable for indoor and outdoor dry, damp and wet locations (Only applies to non-Gimbal types)
- Reduces energy consumption up to 84%
- 120V input voltage
- Lasts up to 25 times longer than incandescent lamps
- No warm-up time, instant-on with full light output and stable lamp to lamp color
- CEC compliant product meets California Title 24 fixture requirements for high efficacy luminaire
- Integrated white trim, white baffle reflector socket adaptor (included) for direct replacement
- Adjustable Gimbal feature (30° tilt and 360° rotation)

* Performance may vary depending on dimmer used in application. Different kit models (NAEDs) should not be mixed on the same dimmer circuit, performance may be affected. Please refer to Dimmer Compatibility List (RETRO-DIM) for a list of compatible dimmers or visit www.SYLVANIA.com/LEDRetrofit.

Quality of Light

The SYLVANIA ULTRA RT Series provides excellent color rendering (82+ and 90 CRI option), and a selection of color temperatures (2700K, 3000K, 4000K and 5000K). LEDs have virtually no UV or infrared radiation to damage or fade furnishings, art or other objects.

Optical Design

Optical design efficiently directs light output in an 80° beam angle with low glare.

Accessories

Assorted color retrofit trims, GU24 socket adaptor, push wire adaptor, retrofit band.

Product Offering

Lumen Output	Wattage	Color Temperature
700	10	2700K, 3000K, 4000K, 5000K
700	12	2700K, 3000K, 4000K
900	13	2700K, 3000K, 5000K
1200	16	2700K, 3000K, 4000K

Specifications and Certifications



Specification Data

Catalog #	Type
Project	
Comments	
Prepared by	

Specifications

Energy Data

Minimum Starting Temp: -40°F (-40°C)
EMI/RFI: FCC Title 47 CFR, Part 15, Class B
Sound Rating: <24dBA
Input Voltage: 120V
Power Factor: >0.90
Input Frequency: 60Hz

THD: <20%

Input Power: 10W, 12W, 13W & 16W

Input Current: 0.08A & 0.1A

Maximum Ambient Operating Temperature (Insulated Ceiling or Non-Insulated Ceiling): 104°F (40°C)

Lighting Data

Lumen Output: 700, 900 & 1200

Color

Correlated Color Temperature (CCT): 2700K, 3000K, 4000K, 5000K
Color Rendering Index (CRI): Up to 90

Ordering Information

Item Number	Ordering Abbreviation	Recessed Housing	Replaced Incandescent Wattage	Nominal Wattage (W)	Delivered Light Output (lm)	Color Temperature	CRI	R9	Avg. Rated Life (hrs)*
74290	LED/RT/5/6/700/927/FL80	5 in. and 6 in.	65W	10	700	2700K	90	15	50,000
74291	LED/RT/5/6/700/930/FL80	5 in. and 6 in.	65W	10	700	3000K	90	15	50,000
73157	LED/RT/5/6/700/840/FL80	5 in. and 6 in.	65W	10	700	4000K	83	15	50,000
74293	LED/RT/5/6/700/950/FL80	5 in. and 6 in.	65W	10	700	5000K	90	15	50,000
73860	LED/RT/5/6/700/927/FL80/CEC 2/CS 1/SKU**	5 in. and 6 in.	65W	12	700	2700K	90	50	50,000
73861	LED/RT/5/6/700/930/FL80/CEC 2/CS 1/SKU**	5 in. and 6 in.	65W	12	700	3000K	90	50	50,000
73862	LED/RT/5/6/700/940/FL80/CEC 2/CS 1/SKU**	5 in. and 6 in.	65W	12	700	4000K	90	50	50,000
74294	LED/RT/5/6/900/927/FL80	5 in. and 6 in.	75W	13	900	2700K	90	15	50,000
74295	LED/RT/5/6/900/930/FL80	5 in. and 6 in.	75W	13	900	3000K	90	15	50,000
73466	LED/RT/5/6/G/900/827/FL80RP	5 in. and 6 in.	75W	13	900	2700K	84	15	50,000
73467	LED/RT/5/6/G/900/830	5 in. and 6 in.	75W	13	900	3000K	84	15	50,000
79750	LED/RT/5/6/1200/927	5 in. and 6 in.	100W	16	1200	2700K	90	15	50,000
79751	LED/RT/5/6/1200/930	5 in. and 6 in.	100W	16	1200	3000K	90	15	50,000
79752	LED/RT/5/6/1200/930RP	5 in. and 6 in.	100W	16	1200	4000K	90	15	50,000
79753	LED/RT/5/6/1200/940	5 in. and 6 in.	100W	16	1200	4000K	90	15	50,000

* LED lamp life is defined as the number of hours when 50% of an average group of identical lamps reached 70% of its initial lumens.

** Ships with GU24 base, medium base adaptor sold separately. 73860 replaces 72578; 73861 replaces 72579; 73862 replaces 72593.

Ordering Guide

LED	RT5/6	G	900	8	30	CEC
LED	Product Name: RT6 5/6=fits 5" and 6" housing	Gimbal	Light Output 900 lm	CRI >80	Color Temperature 3000K	CEC compliant, ships with a GU24 base

Energy Savings

Basic Product Description	LED		Traditional Lamp Types	Lumens	Life	Watts Saved With RT6	RT6 Energy Savings*	RT6 Life Benefit
RT5/6 10W	700	50,000	Incandescent 65WBR30	640	2000	55	\$302	25X
RT5/6 13W	900	50,000	Incandescent 75WBR40	935	2000	62	\$341	25X
RT5/6 16W	1200	50,000	Incandescent 100WBR40	1,600	2000	84	\$462	25X

* Based on \$0.11/kWh over 50,000 hours life.

Application Information

Application Notes

- Operating temperature range between -40°F and 104°F (-40°C and 40°C).
- Suitable for indoor and outdoor dry, damp and wet locations (Non-Gimbal only). Suitable for indoor and outdoor dry, and damp locations (Gimbals only)
- Suitable for dimmers or in housings controlled by a dimmer. For a list of compatible dimmers, please refer to www.sylvania.com.
- The SYLVANIA ULTRA RT Series recessed downlight kits are dimmable down to 10% of full light output with compatible dimmers. The minimum dimming value is based on light output using compatible dimmers, and may not be an indication of the kit's full rated capability.
- Not intended for use with emergency light fixtures or exit lights.
- For use in housings that can structurally support a lamp weighing one pound.
- RT5/6 designed to install in standard 5" and 6" insulated and non-insulated housings.
- For detailed warranty information, please refer to www.sylvania.com/RT6.
- Compatible with Philips Bodine model ELI-S-20 and IOTA model IIS-125 Emergency Lighting Inverters.

Assembly Diagram

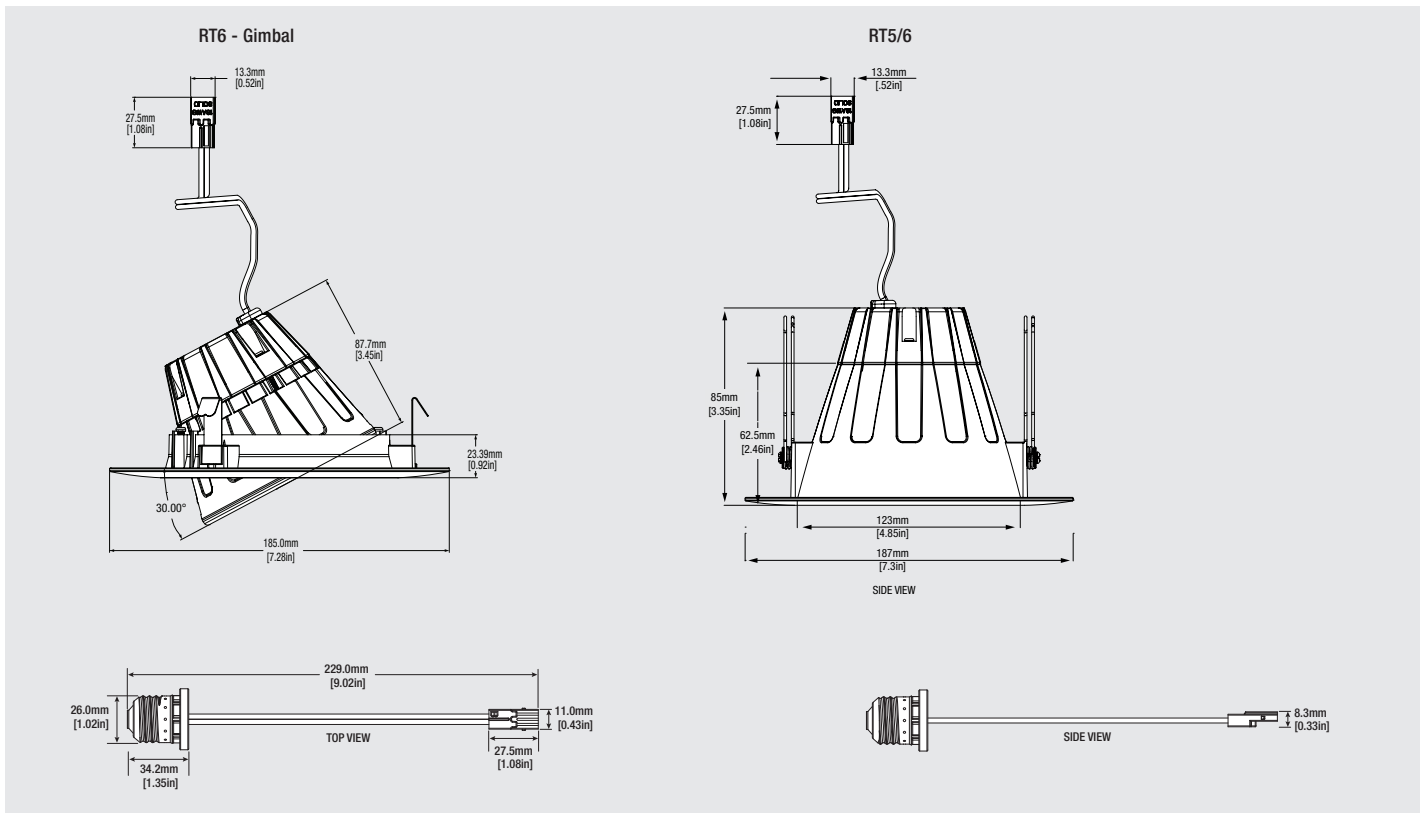

Accessories

Socket Adaptor

- | | |
|-------|---------------------------------------|
| 75105 | LED/ADAPTOR/GU24 (sold separately) |
| 75096 | LED/ADAPTOR/MEDBASE (sold separately) |

Push Wire Adaptor

- | | |
|-------|--|
| 75107 | LED/ADAPTOR/PUSHWIRE (sold separately) |
|-------|--|

Retrofit Band (For 6" housing models Progress Lighting P87-AT and Lightolier 1104IC)

- | | |
|-------|------------------------------------|
| 70663 | RT6/RETROFITBAND (sold separately) |
|-------|------------------------------------|

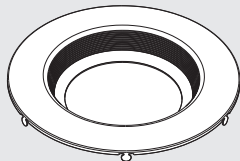
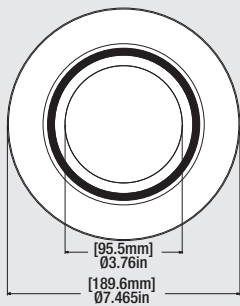
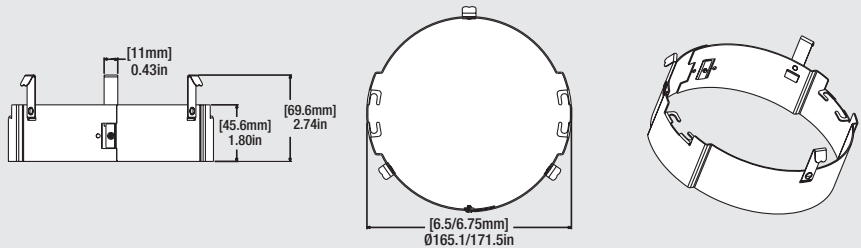

RT5/6 Retrofit Trim (For non-Gimbal only, can be used with RT5/6 and RT6)

- | | |
|-------|------------------|
| 75095 | RT/5/6/TRIM/DKBZ |
| 75097 | RT/5/6/TRIM/BLK |
| 75098 | RT/5/6/TRIM/ORBZ |
| 75099 | RT/5/6/TRIM/SN |

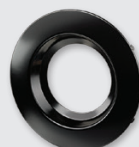

75097



75098



75099

Photometric Information

ULTRA RT6 700

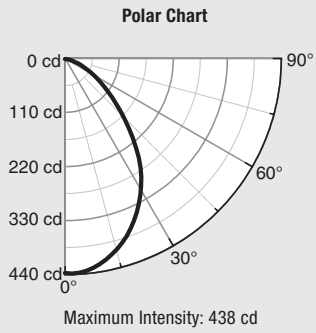

Illuminance at Distance

	Illuminance		Beam Diameter	
	Edge	Center	V	H
2 ft	26.0 fc	109.5 fc	3.2 ft	3.2 ft
4 ft	6.5 fc	27.4 fc	6.4 ft	6.4 ft
6 ft	2.9 fc	12.2 fc	9.6 ft	9.6 ft
8 ft	1.6 fc	6.8 fc	12.8 ft	12.3 ft
10 ft	1.0 fc	4.4 fc	16.1 ft	16.1 ft
12 ft	0.7 fc	3.0 fc	19.3 ft	19.3 ft

Vert. Spread: 77.6° Horiz. Spread: 77.5°

Zonal Lumen Distribution

Zone	Lumens	% Fixture
0-30	305.6	41.3
0-40	462.6	62.5
0-60	668.3	90.3
60-90	71.5	9.7
0-90	739.8	100.0
90-180	0.0	0.0
0-180	739.8	100.0

Spacing to Mounting Height Ratio

Spacing Criteria (0-180°)	1.04
Spacing Criteria (90-270°)	1.08
Spacing Criteria (Diagonal)	1.12

ULTRA RT6 900

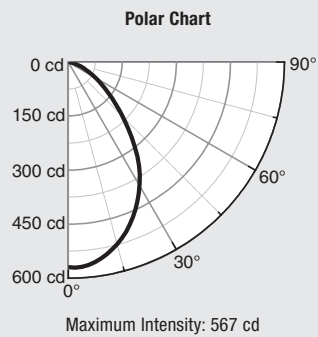

Illuminance at Distance

	Illuminance		Beam Diameter	
	Edge	Center	V	H
2 ft	35.0 fc	141.8 fc	3.1 ft	3.1 ft
4 ft	8.8 fc	35.4 fc	6.2 ft	6.1 ft
6 ft	3.9 fc	15.8 fc	9.3 ft	9.2 ft
8 ft	2.2 fc	8.9 fc	12.4 ft	12.3 ft
10 ft	1.4 fc	5.7 fc	15.5 ft	15.4 ft
12 ft	1.0 fc	3.9 fc	18.6 ft	18.4 ft

Vert. Spread: 75.5° Horiz. Spread: 75.1°

Zonal Lumen Distribution

Zone	Lumens	% Fixture
0-30	393.6	43.2
0-40	589.4	64.7
0-60	828.9	91.0
60-90	81.7	9.0
0-90	910.6	100.0
90-180	0.0	0.0
0-180	910.6	100.0

Spacing to Mounting Height Ratio

Spacing Criteria (0-180°)	1.02
Spacing Criteria (90-270°)	1.04
Spacing Criteria (Diagonal)	1.10

ULTRA RT6 1200

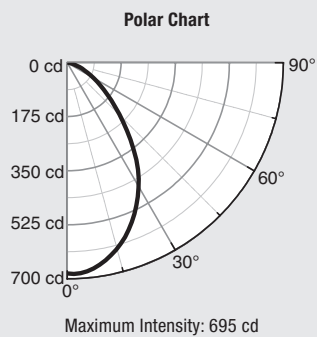

Illuminance at Distance

	Illuminance		Beam Diameter	
	Edge	Center	V	H
2 ft	38.4 fc	171 fc	3.4 ft	3.4 ft
4 ft	9.6 fc	42.8 fc	6.7 ft	6.7 ft
6 ft	4.3 fc	19 fc	10.4 ft	10.4 ft
8 ft	2.4 fc	10.7 fc	13.4 ft	13.4 ft
10 ft	1.5 fc	6.8 fc	16.8 ft	16.8 ft
12 ft	1.1 fc	4.8 fc	20.1 ft	20.1 ft

Zonal Lumen Distribution

Zone	Lumens	% Fixture
0-30	503.0	39.0
0-40	61.0	61.0
0-60	1163.0	91.0
0-90	1275.0	100.0
90-180	0.0	0.0
0-180	1275.0	100.0

Spacing to Mounting Height Ratio

Spacing Criteria (0-180°)	1.14
Spacing Criteria (90-270°)	1.14
Spacing Criteria (Diagonal)	1.18

LEDVANCE LLC
200 Ballardvale Street
Wilmington, MA 01887 USA
Phone 1-800-LIGHTBULB (1-800-544-4828)
www.sylvania.com

SYLVANIA and LEDVANCE are registered trademarks.
All other trademarks are those of their respective owners.
Product Licensee of Trademark SYLVANIA in General Lighting.
Specifications subject to change without notice.

 [/sylvania](https://twitter.com/sylvania)  [/sylvania](https://facebook.com/sylvania)

© 2016 LEDVANCE

