

Description

The Halo RL56 Wireless is a complete LED Baffle-Trim Module for 5" and 6" aperture recessed downlights. When paired with a ZigBee based system, the RL56 Wireless can perform dimming, white tuning, scheduling, grouping, geo-fencing, automations, and remote access all through a mobile device. The RL56 Wireless is cULus Listed for use with Halo, and is UL Classified for use with compatible 5" and 6" housings. The RL56 Wireless lens provides uniform illumination and wet location listing. Precision construction makes any housing AIR-TITE for added savings and code compliance.

Catalog #		Type
Project		
Comments		Date
Prepared by		

Specification Features

Wireless Systems

- Certified for use with Wink and SAMSUNG Smartthings hubs.
- Group, Schedule, Geo-fence, and automate lighting actions through hub manufacturer's app.
- Utilizes ZigBee Home Automation protocol.
- Wireless functionality requires internet connection to Hub

Wireless Pairing

- See Halo LED RL56 and RL4 Quick Start guide for wireless setup, guidance and troubleshooting.
- Light must be 40 meters or 131 feet from the hub for initial connection and installation.

Module - Trim

- Module construction includes LED Array, heat sink, reflector, lens, baffle and trim ring
- Regressed baffle
- Heat sink designed to conduct heat away from the LED Array keeping the junction temperatures below specified maximums, even when installed in insulated ceiling environments

Optics

- Regressed lens
- Impact-resistant polycarbonate
- Convex form and lamp-like appearance
- Diffuse for even illumination

Mounting

- Integral torsion springs and Push-N-Twist clips offer two mounting options
 - Torsion springs are pre-installed and adjust to fit 5" or 6" compatible housings
 - Push-N-Twist universal installation clips are designed to fit 5" and 6" compatible housings

Housing Compatibility

See Housing Compatibility

LED

- Mid power led array provides a uniform source with high efficiency and no pixilation.
- 90 CRI minimum, R9 greater than 50.
- Color accuracy within 3 SDCM at the CCT end points and 4 SDCM in between end points, provide color accuracy and uniformity.
- Color Temperature (CCT) has an adjustable range from 2700K to 5000K (factory default 3000K)
- L70 at 50,000 hours

LED Chromaticity

- A tight chromaticity specification ensures LED color uniformity, sustainable Color Rendering Index (CRI), and Correlated Color Temperature (CCT) over the useful life of the LED.
- LED chromaticity of 3 SDCM meets ENERGY STAR color standards

Gaskets

- Closed cell gasket achieves restrictive airflow and wet location requirements without additional caulking

Driver

- Integral 120V 50/60Hz constant current dimmable driver provides high efficiency operation
- In the app, continuous dimming from 100% to 5%.
- Not recommended for use with any in-wall dimmers.
- Dimming to 5% is best assured when using Halo recommended hub manufactures.
- Inline electrical quick connect and E26 adapter (provided) provides mains connections.
- Consult instruction sheets and quick start guide for more information

Designer Skins (sold separately)

- RL56 skins are accessory rings that attach to the RL56 for a permanent finish. Refer to the RL56 accessories specification sheet for details.
- White (Paintable)
 - Satin Nickel
 - Tuscan Bronze

Compliance

- cULus listed / certified for use with Halo housings, classified for use with other's housings, see instruction sheet for conditions of acceptability.
- Air-Tite certified per ASTM E283
- Wet and Damp Location listed
- Suitable for use in clothes closets when installed in accordance with the NEC 410.16 spacing requirements.
- EMI/RFI emissions per FCC 47CFR Part 15B
- Contains no mercury or lead and RoHS compliant.
- Photometric testing in accordance with IES LM-79-08
- Lumen maintenance projections in accordance with IES LM-80-08 and TM-21-11.
- Can be used for State of California Title 24 high efficacy luminaire compliance. Complies with Title 24 JA8-2016-E
- Can be used for International Energy Conservation Code (IECC)
- FCC ID: 2AKCY-RL56ZHA
- IC: 4706A-RL56ZHA

Warranty

Five year limited warranty, consult website for details.
www.eaton.com/lighting/legal



RL56 Wireless
White

600 Series
5/6-Inch LED
Recessed Retrofit
Module-Trim

90CRI
CCT Adjustable
Range from 2700K-5000K

FOR USE IN
INSULATED CEILING
AND NON- INSULATED
CEILING RATED
HOUSINGS

HIGH-EFFICACY LED
WITH INTEGRAL
DRIVER



Refer to ENERGY STAR® Qualified Products List.
Can be used to comply with California Title 24 High Efficacy requirements.
Certified to California Appliance Efficiency Database under JA8.



RL56 Dimensions

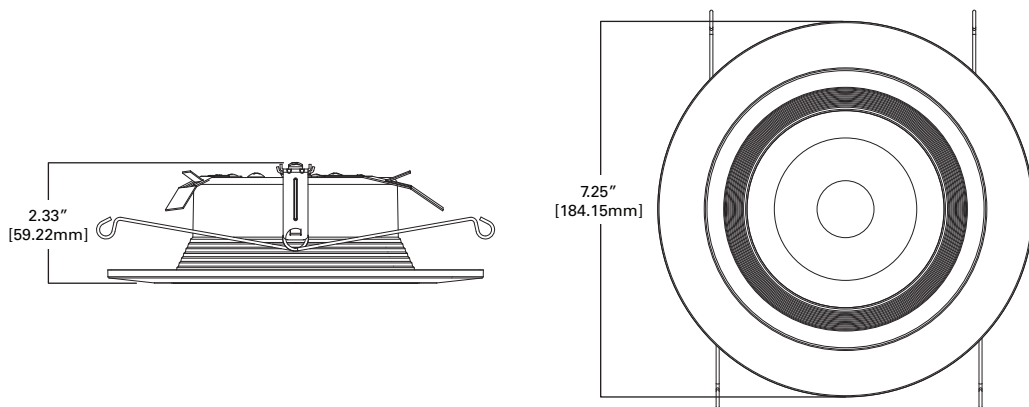

Designer Trim Dimensions

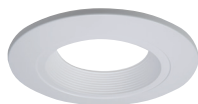
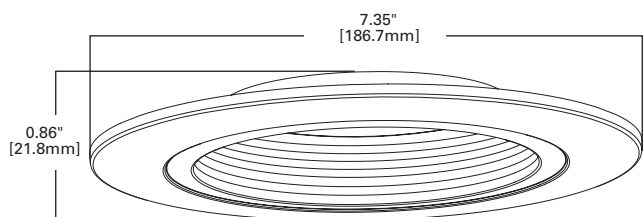

RL56TRMWHB
White (Paintable)

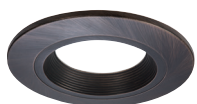

RL56TRMTBZB
Tuscan Bronze

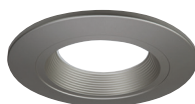

RL56TRMSNB
Satin Nickel

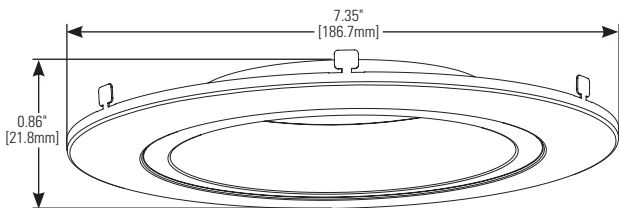

RL56TRMWH
White (Paintable)

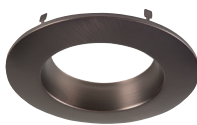

RL56TRMTBZ
Tuscan Bronze



RL56TRMSN
Satin Nickel

Energy Data

RL56 Series (Values at non-dimming line voltage)

Minimum Starting Temp: -30°C (-22°F)
EMI/RFI: FCC Title 47 CFR, Part 15, Class B (Consumer)
Sound Rating: Class A
Input Voltage: 120V
Power Factor: >0.90
Input Frequency: 60Hz
THD: <20%
Input Power: 9.7W
Input Current: 0.15A
Maximum IC (Insulated Ceiling) Ambient Continuous Operating Temperature: 25°C (77°F)
Maximum Non-IC Ambient Continuous Operating Temperature 40°C (104°F)

Ordering Information

Sample Number: **RL560WHZHA69** - 5"/6" Retrofit LED Module, Zigbee HA, 90CRI, Matte White

Complete unit includes a RL56 Baffle-Trim LED Module and a 5" or 6" compatible housing, ordered separately. Optional accessory designer trim ring ordered separately.

Module	Finish	Protocol	Lumens	CRI
RL560 = 5"/6" Retrofit Baffle Trim, LED Module, ZigBee Wireless, 90CRI, Tunable White 2700K-5000K	WH =Matte White	ZHA =ZigBee Home Automation	6 =600 lumens (nominal)	9 =90 CRI

Housing Compatibility

Compatible Halo LED Housings with LED luminaire connector (high-efficacy compliant)		
HALO LED	Recessed Can Size	Catalog Number
	5"	H550ICAT, H550RICAT, E550ICAT, E550RICAT
	6"	H750ICAT, H750RICAT, H750T, H750RINTD010, H750TCP, H2750ICAT, H2750RICAT, E750ICAT, E750RICAT
Halo LED Retrofit Enclosures		
HALO	6"	ML7BXRFK, ML7E26RFK
Compatible Halo Incandescent E26 Screwbase Housings		
HALO	5"	H5ICAT, H5RICAT, H5ICATNB, H5T, H5RT, H25ICAT, H25ICATNB, E5TAT, E5RTAT, H5TNB, E5TATNB, E5ICAT, E5RICAT, E5ICATNB
	6"	H7ICAT, H7RICAT, H7ICT, H7RICT, H7ICATNB, H7ICTNB, H7T, H7RT, H7TNB, H7TCP, H7UICAT, H7UICATNB, H27ICAT, H27RICAT, H27T, H27RT, E7ICAT, E7RICAT, E27ICAT, E27RICAT, E7ICATNB, E7TAT, E7RTAT, E7TATNB, E27TAT, E27RTAT
Compatible All-Pro Incandescent E26 Screwbase Housings		
ALL-PRO	5"	EI500AT, EI500RAT, ET500, ET500R
	6"	EI700AT, EI700RAT, EI700, EI700R, EI700ATNB, EI700NB, EI700U, EI700UAT, ET700, ET700R, EI2700AT, EI2700, EI2700R, ET2700, ET2700R

RL56 Series LED Retrofit is UL Classified for retrofit in the follow 5/6" recessed housings:

The RL Series LED light module - trim combination is cULus Listed or UL Classified for use with any 5"/6" diameter recessed housing constructed of steel or aluminum with an internal volume that exceeds 107.9 in³ in addition to those noted above.

Photometric Data

RL56 Wireless Photometric*

RL560WHZHA69-3000K		
Luminaire lumens	685	
Input watts	9.5	
LER (LPW)	72.1	
Spacing Criteria	0-180	1.14
	90-270	1.14
	Diagonal	1.22
Beam angle (degrees)	87.8	
Field angle (degrees)	139	
Zonal lumen	Lumens	% Lumens
0-30	255	37.2
0-40	399	58.2
0-60	612	89.4
0-90	685	100

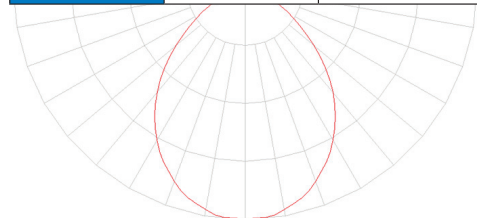

Color Metric Summary

TM-30-15	R _r = 89.6
	R _g = 97.7
CRI/CIE	R _a = 93.7
	R ₉ = 71.7



Lighting Facts

HALO

LED lighting facts
A Program of the U.S. DOE

Light Output (Lumens) 685
Watts 9.5
Lumens per Watt (Efficacy) 72.11

Color Accuracy
Color Rendering Index (CRI) 90

Light Color
Correlated Color Temperature (CCT) 3000 (Bright White)

2700K 3000K 4500K 6500K

All results are according to IESNA LM-79-2008: Approved Method for the Electrical and Photometric Testing of Solid-State Lighting. The U.S. Department of Energy (DOE) verifies product test data and results.

Visit www.lightingfacts.com for the Label Reference Guide.

Registration Number: F4QJ-NV6YE1 (3/21/2017)
Model Number: RL560WHZHA69-3000K
Type: Luminaire - Downlight

* Tested in accordance with IES LM63. Field results may vary.