

BLUEGRASS *Living*

OUTDOOR GAS FIRE PIT OWNER'S OPERATION AND INSTALLATION MANUAL

MODEL No.: HF42708

SKU No.: 140349

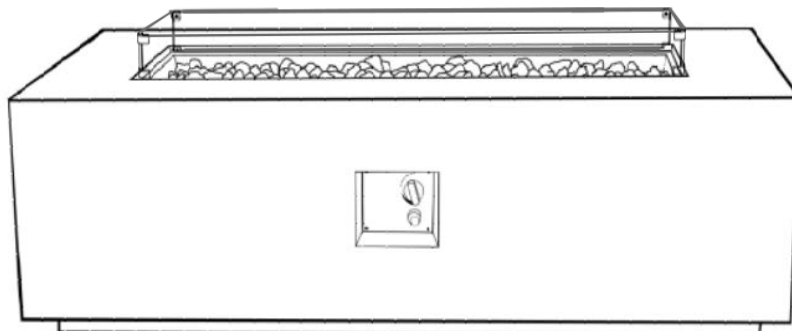

Questions, problems, missing parts? **Before returning to your retailer, call our customer service department at 1-866-762-4050, 8:00 am - 4:30 pm CST, Monday through Friday or email service@bluegrassliving.com**

LIMITATION OF WARRANTY AND LIABILITY

NOTICE: Read this Limitation of Warranty and Liability Before Using This Product. If the Terms Are Not Acceptable, Return the Product at Once, Unopened, and the Purchase Price Will Be Refunded.







It is impossible to eliminate all risks associated with the use of this product. Such risks arise from weather conditions, the manner of use or application, or other unknown factors, all of which are beyond the control of the Seller and Manufacturer. These risks can cause bodily injury or death, ineffectiveness of the product, and damage to other property. Seller and Manufacturer will not be held liable for such risks. By using this unit you are accepting these risks.

Seller and Manufacturer warrant that this product is reasonably fit for the purpose stated in the Owner's Instructions Manual, subject to the inherent risks described above, when used in accordance with the Owner's Instructions Manual under normal conditions.

The Seller and Manufacturer will not be held liable for any claims, losses, injuries or damages resulting from the misuse or handling of this product.

Any claim by buyer or user of this product shall be filed within one (1) year of the date of injury or damage or the claim will be barred. Buyer and user waive any right to file any class action claim for product defect, design defect, or failure to adequately warn of product hazards or safe installation.

This Limitation of Warranty and Liability may not be amended by any oral or written agreement.

 WARNING	FOR OUTDOOR USE ONLY !
 DANGER	If you smell gas and/or hear a gas hissing sound: 1.Immediately, SHUT OFF gas to the appliance. 2.Extinguish ALL open flames. 3.If odor continues, keep away from the appliance and immediately call your Gas Supplier or Fire Department.
 DANGER	DO NOT store or use gasoline or other flammable vapors and liquids in the vicinity of this unit and or any other appliance. An LP Gas tank not connected for use shall not be stored in the vicinity of this or any other appliance.
 DANGER	Improper installation, adjustment, alteration, service or maintenance can cause injury or damage to property. Read and understand the Owner's Manual thoroughly before installing or servicing this Fire Table. If the information in this Owner's Manual is NOT followed exactly, a fire or explosion may result and cause property damage, personal injury or loss of life.
 DANGER	CARBON MONOXIDE HAZARD. This appliance can produce carbon monoxide, which is odorless.
	Using it in an enclosed space can kill you. Never use this appliance in an enclosed space such as inside a camper, tent, car or home.

**Save this Owner's Manual and these instructions for future use.
If you are assembling this unit for someone else, give this Owner's Manual to them to read.**





Before You Begin

1. Check for damaged or missing parts.
2. Use the carton as a working surface to prevent product damage during assembly.
3. Gather all tools prior to assembly.

Safety Information

Before you assemble or operate this unit, please carefully read this entire manual. Failure to do so may result in a fire explosion, injury or death.

NOTE: You must follow all steps to properly assemble this heating item. Make sure the gas valve is turned "OFF" before assembling. Do NOT attempt to assemble without proper tools.

Part A.	SAFETY INFORMATION
<p>Before you assemble or operate this unit, please read carefully this entire Owner's Manual. Failure to do so may result in a fire, explosion, injury or death.</p>	
	<p>The installation of this unit must adhere to local codes or either the National Fuel Gas Code, ANSI Z223. 1/NFPA54, ORCAN/CGA-B149.1, National Gas and Propane Installation Code.</p>
<ul style="list-style-type: none"> • THIS UNIT IS INTENDED FOR OUTDOOR USE ONLY ! This product shall be used outdoors, in a ventilated space and shall not be used in any enclosed area. 	
<ul style="list-style-type: none"> • This unit can be converted to natural gas. Please contact customer service for more information 	
<ul style="list-style-type: none"> • Do not use any solid fuel or charcoal for this unit. 	
<ul style="list-style-type: none"> • When igniting this unit, exercise caution as some gas pooling from the burner may cause the flame to flare that could cause injury. 	
<ul style="list-style-type: none"> • LP GAS WARNING: Lava Rocks/Pumice Stones/ Fire Glass not to exceed 1/4 inch depth above the burner holes. Excessive use of lava rocks/pumice stones/fire glass will suffocate the flame. • If the Propane Gas Tank is leaking gas, you can smell, hear a hiss, or sense a leak at the source. Do the following: <ol style="list-style-type: none"> 1. Disconnect the Propane Gas tank. 2. DO NOT attempt to fix the problem yourself. 3. Move yourself and all persons away from the immediate area. 4. Only when everyone is at a safe distance away from the Fire Table, contact your Gas Supplier or Fire Department for help. 	
<ul style="list-style-type: none"> • Applying too much Propane Gas may result in a pooling effect and will NOT burn. Allow fresh air into the unit so that the remaining gas may escape. 	
<ul style="list-style-type: none"> • DO NOT use a flame to check for gas leaks. 	
<ul style="list-style-type: none"> • The maximum inlet supply pressure: maximum Gas supply 11" w.c. (2.74kPa) 	
<ul style="list-style-type: none"> • Use LP propane tanks with the following dimensions: diameter 12", height 18" - capacity 20lbs. 	
<ul style="list-style-type: none"> • You must use a Propane Gas Tank that has a collar to protect the Gas Valve. 	

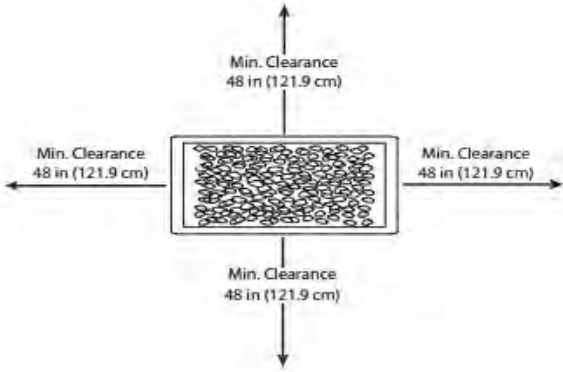
<ul style="list-style-type: none"> • DO NOT fill tank over <u>80% full</u>.
<ul style="list-style-type: none"> • The tank system must be set up for vapor with drawal.
<ul style="list-style-type: none"> • STOP using if any part of the Propane Gas Tank is damaged. Rust and dents in tank may be hazardous and should be inspected by a Gas Supplier.
<ul style="list-style-type: none"> • DO NOT burn anything other than the provided materials for this Fire Table.
<ul style="list-style-type: none"> • Keep away from the unit for the first 20 minutes after igniting your unit for the first time, as lava rocks/pumice stones/fire glass could pop out and cause injury. Should any rocks pop out, discard them.
<ul style="list-style-type: none"> • Always ensure that lava rocks/pumice stones/fire glass are completely dry before use. Failure to do so will cause them to crack or pop.
<ul style="list-style-type: none"> • DO NOT operate unit until all parts are fully assembled.
<ul style="list-style-type: none"> • DO NOT paint or color any part of this Fire Table.
<ul style="list-style-type: none"> • Unit may be hot while in use, DO NOT attempt to move it while in use.
<ul style="list-style-type: none"> • Never leave this Fire Table unattended while in use.
<ul style="list-style-type: none"> • <u>This unit is NOT intended for cooking.</u>
<ul style="list-style-type: none"> • Keep a safe distance to avoid burning skin or clothing.
<ul style="list-style-type: none"> • DO NOT sit or rest hands or feet on this Fire Table.
<ul style="list-style-type: none"> • Never place hands or fingers onto upper portion of this unit while in use.
<ul style="list-style-type: none"> • Keep all electrical cords and fuel supply hose away from heated surfaces.
<ul style="list-style-type: none"> • Combustible material should NOT be within 72 inches of the top of the unit, and within 48 inches around the entire unit. Combustible materials could be and are not limited to any items that may catch fire such as dry vegetation, wood, branches, leaves, plants, buildings, structures, fabrics, clothing, sawdust, all chemicals, and all flammable liquids.
 <p>The diagram illustrates the required minimum clearance around the fire table. A central rectangular box represents the fire table, filled with a pattern of small circles. Four arrows point outwards from the box: one upwards, one downwards, one to the left, and one to the right. Each arrow is accompanied by the text 'Min. Clearance 48 in (121.9 cm)', indicating that there must be at least 48 inches of clear space on all sides of the unit.</p>

<ul style="list-style-type: none"> • Keep the appliance area clear and free from combustible material, gasoline and other flammable vapors and liquids.
<ul style="list-style-type: none"> • If the flame goes out while burning, turn the gas valve off. Wait 5 minutes before repeating the initial lighting procedure. Once you have a flame started, hold down the control knob for 1 minute.
<ul style="list-style-type: none"> • DO NOT add water into the unit.
<ul style="list-style-type: none"> • DO NOT operate unit if any part has been under water. Immediately call for a <u>Qualified Service Technician</u> to inspect the appliance. Where necessary, secure Qualified Service Technician to replace part(s) of the Control System and any gas control parts that has been under water.
<ul style="list-style-type: none"> • DO NOT disconnect any part while the unit is in use.
<ul style="list-style-type: none"> • DO NOT store a spare Propane Gas Tank on or near this unit.
<ul style="list-style-type: none"> • This unit is for outdoors use ONLY.
<ul style="list-style-type: none"> • DO NOT operate on a boat or vehicle. This unit can only be used on any stationary outdoor flat surface ONLY.
<ul style="list-style-type: none"> • Always remove protective cover before operating(where applicable) and/or use of your Fire Table.
<ul style="list-style-type: none"> • DO NOT set the Protective Cover(E) over the unit until the Fire Table is turned off and completely cooled down(where applicable).
<ul style="list-style-type: none"> • Check for leaks after not using the unit for long periods of time.
<ul style="list-style-type: none"> • Children must never operate this FireTable. Children must be supervised AT ALL TIMES while near this Fire Table.
<ul style="list-style-type: none"> • The maximum gas supply pressure is <u>250 psi</u>.
<ul style="list-style-type: none"> • All installation and repair should be done by a <u>Qualified Service Technician</u>. This unit should be inspected annually and cleaned regularly.
<ul style="list-style-type: none"> • Inspect all elements of this Fire Table before each use. If there is damage, the burner must be replaced.
<ul style="list-style-type: none"> • Be aware of the hazards of high temperatures and stay away from the unit to avoid any burns or injury.
<p>•The gas supply tank should be constructed and marked with the specifications for the LP Gas tanks of the U.S Department of Transportation or the National Standard of Canada CAN/ CSA-B339, LP Gas tanks, spheres and tubes for Transportation of Dangerous Goods and Commission.</p>
<ul style="list-style-type: none"> • The LP Gas tank must have a listed over filling prevention device and a QCCI or Type I, LP Gas tank connection.

• Children and adults should be alerted to the hazards of high surface temperatures and should stay away to avoid burns or clothing ignition.

• Young children **MUST BE** carefully supervised at all times when they are in the area of this appliance.

• Clothing or other flammable materials shall **NOT** be hung from the appliance or placed on or near the appliance.

• Any guard or other protective device removed for servicing the appliance shall be replaced prior to operating and use of this appliance.

• Installation and repair(s) should be done by a **Qualified Service Technician**.

The appliance should be inspected before use. If you suspect there are issues, contact a **Qualified Service person**.

More frequent cleaning may be required as necessary. It is imperative that the control compartment, burners and circulating airways of the appliance are kept clean.

When APPLICABLE:

• Keep gas tank at least 5 feet away from unit when lit (if it is an external tank).

• Allow Fire Burner to cool down completely before placing lid.

• Keep the hose away from any pathways to eliminate any accidental damage(if it is an external tank).

Use only the Regulator and Hose assembly provided with this unit.

Replacement parts must be supplied directly by manufacturer.

Inspect the Burner before use of this unit.

If the Burner shows any kind of damage, DO NOT attempt to operate the appliance.

NOTE: You must follow all steps to properly assemble this Fire Table.

Make sure the

Gas Valve is turned "OFF" before assembling. DO NOT attempt to assemble without proper tools.

Part B.

IGNITOR CONTROL BOARD

Here is an exact visual display of the Operation Tablet as found on your FireTable. Read carefully before using.

LIGHTING

1. Read the instructions before lighting.
 2. Control knob must be in "OFF" position.
 3. Connect propane cylinder (See Manual).
 4. Push and turn control knob counter clockwise to Low.
 5. Press the igniter button repeatedly to light burner.
 6. Release control knob after 45 seconds.
 7. If ignition does not occur in 45 seconds, push and turn burner control knob to "OFF", wait 5 minutes, fan with newspaper or magazine, and repeat lighting procedure.
 8. If igniter does not light burner, use a long match or a long butane lighter.
 9. Adjust flame to desired flame with the control knob.
- CAUTION: The gas supply must be turned off at the LP-gas supply cylinder when this appliance is not in use.

TURNING OFF

1. Turn and push the control knob clockwise to the "OFF" position.
2. Turn the cylinder valve on the gas tank clockwise to close.

ALLUMAGE

1. Lisez les directives avant l'allumage.
 2. Il faut que le bouton de commande soit à la position "ARRÊT"
 3. Raccorder la bouteille de propane (voir le guide)
 4. Pousser et tourner le bouton de commande dans le sens anti-horaire à "BAS"
 5. Appuyer sur le bouton d'allumage plusieurs fois pour allumer le brûleur
 6. Relâcher le bouton de commande après 45 secondes.
 7. Si l'allumage ne s'est pas produit pendant les 45 secondes, pousser et tourner le bouton de commande jusqu'à la position "ARRÊT", attendre 5 minutes éventer avec un journal ou une revue répéter ensuite le procédé d'allumage
 8. Si l'allumeur n'allume pas le brûleur, utiliser une allumette longue ou un long allume-feu au butane
 9. Régler la flamme à l'intensité voulue à l'aide du bouton de commande.
- ATTENTION: Il faut fermer le robinet gaz sur la bouteille de GPL lorsque l'appareil n'est pas utilisé

- EXTINCTION: 1. Tourner et pousser le bouton de commande dans le sens horaire jusqu'à la position "ARRÊT"
2. Tourner le robinet de la bouteille de gaz dans les sens horaire pour le fermer.

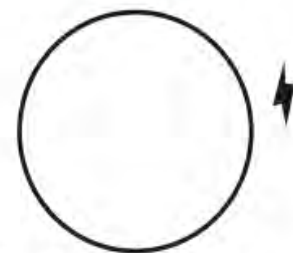
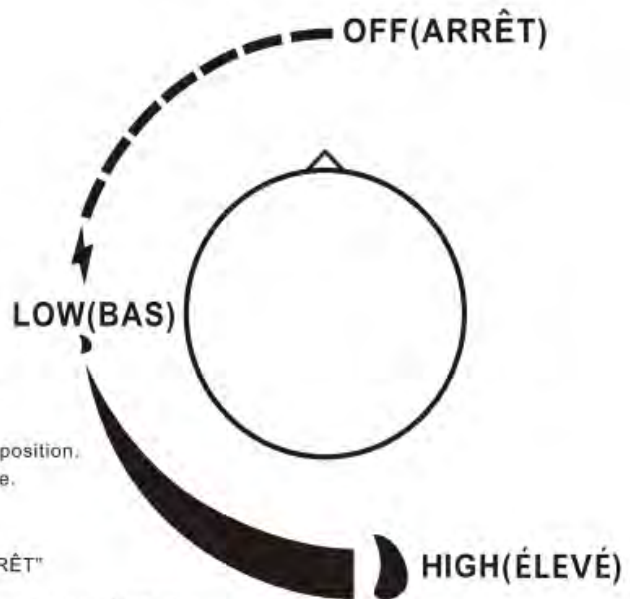

IGNITER-PUSH
ALLUMEUR-POUSSER

Part C. User's Guide to Parts and Accessories of The Regulator, Charge Valve of the Cylinder and Steps to Connecting the Gas Tank to the Fire Table.

This Safety Information section contains information concerning:
 1)The Regulator (pre-connected to the Fire Table).
 2)The Charge Valve of the Gas Tank and its relevant Valves.

Note: There are Fire Tables that hold the Gas Tank INTERNALLY and EXTERNALLY.

The Owner/User must know all the different parts: Charge Valves and Regulator. This picture shows different parts of the Charge Valve of the Gas Tank and the Regulator(12/19) is pre-connected to the Fire Table. The different components and parts of the Gas Tank and the Fire Table Regulator, as show on the picture to the left here.

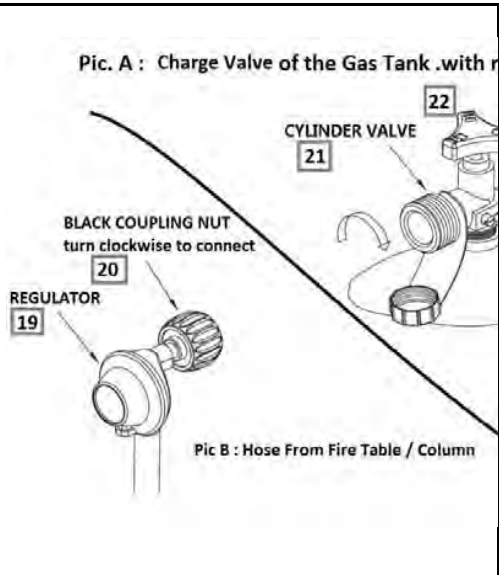

Pic. A: Shows the Charge Valve of the Cylinder with the different Valves and Coupling Nut, these forms the top of the Gas Cylinder.

Pic. B: Shows the Regular pre-connected to a hose. This Regulator is pre-connected to the Fire Table.

Part D.

Connecting the Fire Table to the Gas Cylinder.

This next step guides you to connect the Fire Table Regulator to the Gas Cylinder.

Pic. A : Charge Valve of the Gas Tank .with relevant parts

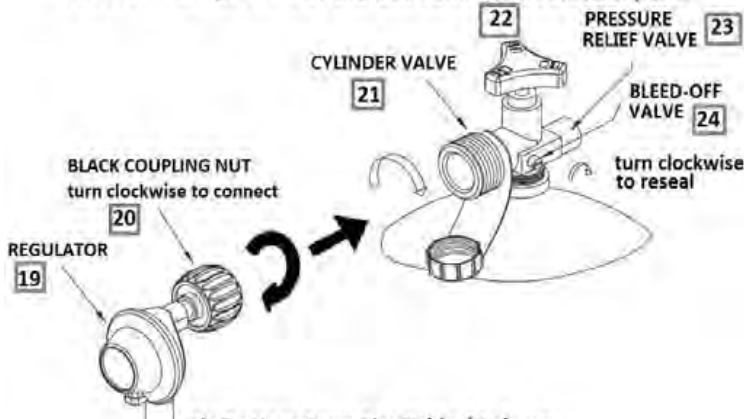

Step1: Connect the Black Coupling Nut on the Regulator to the Cylinder Valve.

Step2: Turn the Black Coupling Nut, fully CLOCKWISE until fully locked into position.

Step 3: In order to Check for Leaks: Brush and water mixture on all connections.

Note: Turn the gas supply on. If any extra large bubbles form on any connection there may be a leak. If you smell gas or a leak is discovered, IMMEDIATELY turn the gas valve off, disconnect Propane Gas tank. Do not use the appliance until the leak is repaired.

Part E.

FIRE TABLE PARTS INTRODUCTION

Your Fire Table is delivered **pre-assembled** where by there is **no assembly actions needed**. Here is an introduction to all the parts that forms your Fire Table.







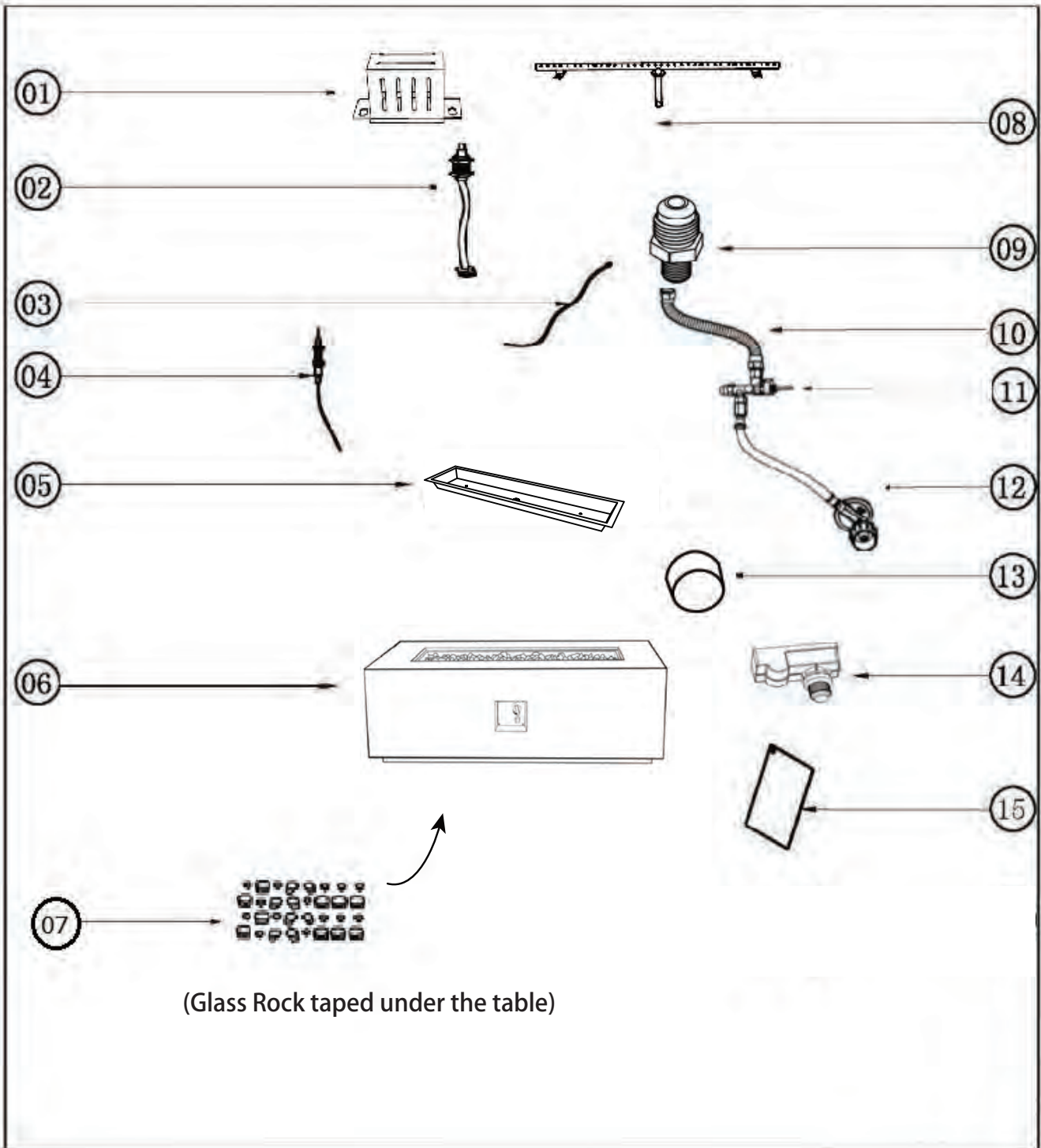



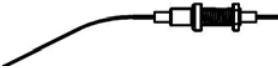

Each part is different and holds its own function.

DO NOT attempt to change and or remove any part(s). In the event of servicing and/or if there are operation issues, contact [Qualified Services Technical Support](#) and or seek [Qualified Service Technician](#).

The reference words below demonstrate the internal components of the burner.

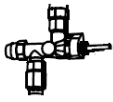

For your convenience all of the above components are individually described on the following page.

Item	Code	Picture	Description	Qty
01	BGF-1701A		Guard	1
02	BGF-1702A		Thermocouple	1
03	BGF-1703A		Groundwire	1
04	BGF-1704A		IgnitionPin	1
05	BGF-1705A		Burner Pan	1
06	HF42708		Fire pit mantel	1
07	BGF-1707A		Glass rocks	1
08	BGF-1708A		Burner	1
09	BGF-1709A		Nozzle	1
10	BGF-1710A		Corrugated pipe	1
11	BGF-1711A		Switching Valve	1
12	BGF-1712A		Regulator valve with gas hose	1
13	BGF-1713A		Control knob	1
14	BGF-1714A		Igniter	1
15	BGF-1715A		ETL warning label	1





Part F.	Parts and Accessories of Fire Table
----------------	--

Here is the User's Guide to various Parts and Accessories to form your complete Fire Table.

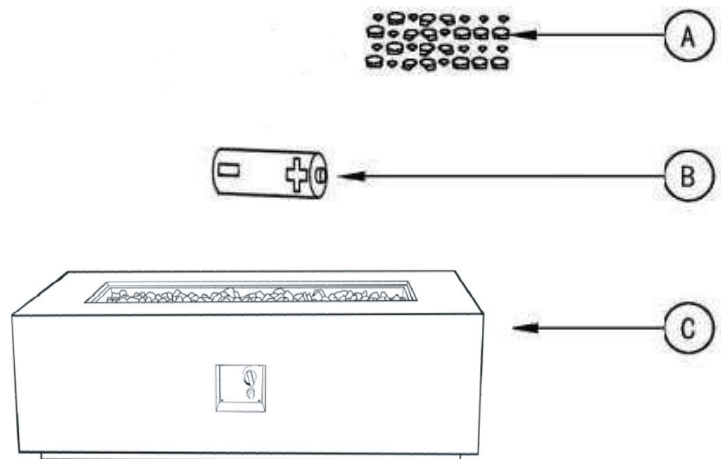
Before you start to assemble this product, make sure all parts are present.
 Compare parts with package contents list.
 If any parts are missing or damaged, DO NOT attempt to assemble the product.

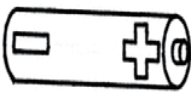
Before Beginning Assembly:

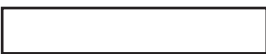

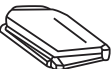
Part G.	Description :			
Item	Code	Picture	Description	
A	BGF-1716A		Glass rocks	8 kg
B	BGF-1717A		Battery	1 pc
C	HF42708		Fire pit mantel	1 pc
D	BGF-1718A		Long glass	2 pcs
E	BGF-1719A		Short glass	2 pcs
F	BGF-1720A		Alu. profile with screw	8 sets
G	BGF-1721A		PVC cover	1 pc

1 Assembling the glass

Unscrew all preassembled screws on the glass clamps, Then, assemble one short glass panel to one long glass panel. Repeat for the other short glass panel and long glass panel. Then, assemble the two glass panel pieces together with the final glass clamps as show below.

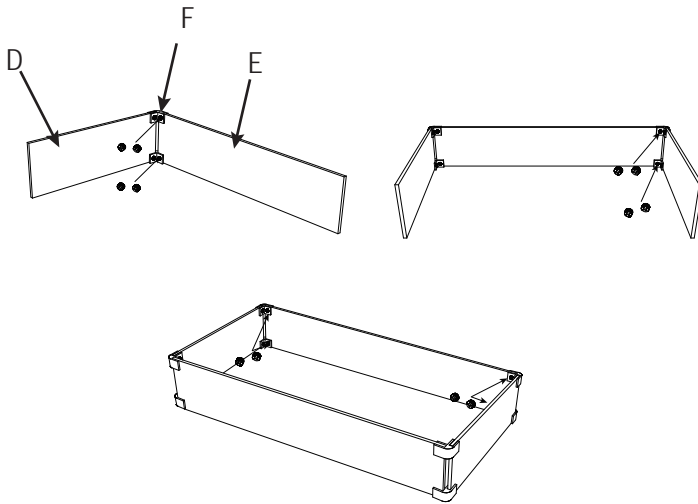

2 Inserting the glass

Insert the glass assembly made in step 1 into the ridge on the top of the fire table mantel

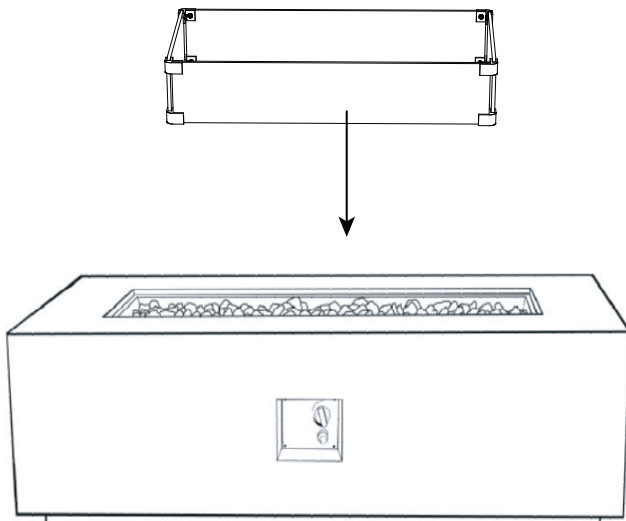

DANGER



HOT GLASS WILL
CAUSE BURNS.
DO NOT TOUCH GLASS
UNTIL COOLED.
NEVER ALLOW CHILDREN
TO TOUCH GLASS.

Part H.

USER'S INSTRUCTIONS

Here are the basic steps to help you light and use your Fire Table.

STEP 1

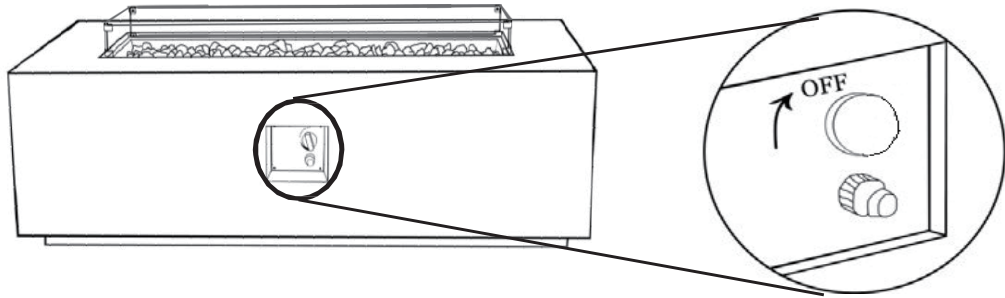

1. Check that the Control Knob(13) for the gas supply system is turned to the "OFF" position before starting any assembly.

2. Place a 20 lb Propane Gas Tank (not included) into a secure position

3. Put the 20 lb. propane gas tank (not included) into the tank house

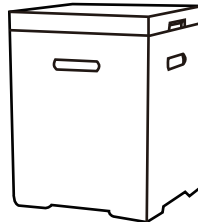
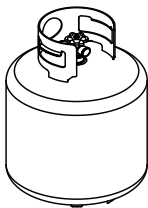

DANGER

Propane tank must be a minimum of 60 inches away at all times.

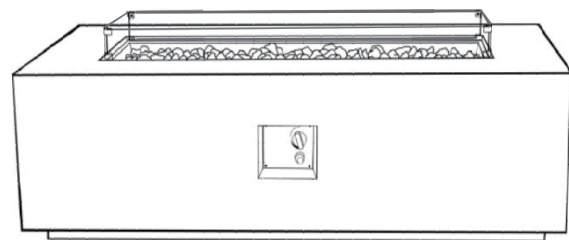
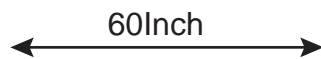
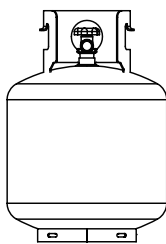

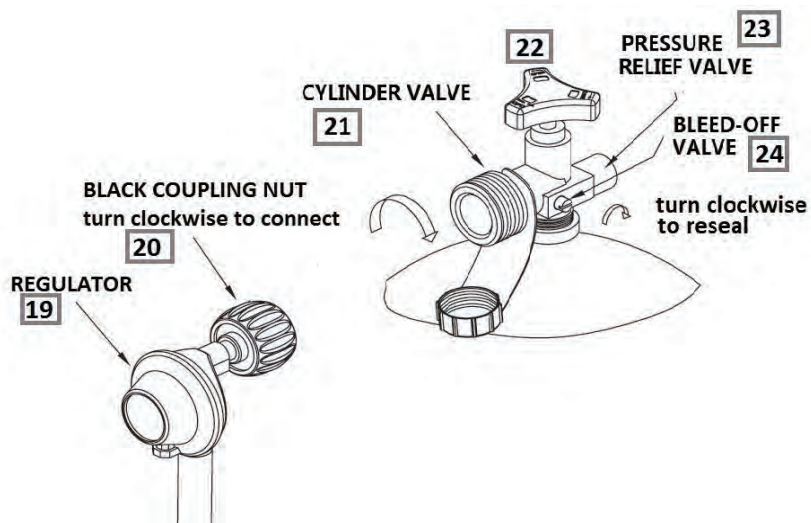

STEP 3

3. Turn the Cylinder Valve(21) on the tank in a clockwise direction to **TURN OFF SUPPLY** of the LP Gas supply
 -Attach the preassembled Regulator(12/19) from the Fire Table to the Cylinder Valve(21) by turning the Black Regulator Coupling Nut(20) clockwise.
 Make sure it is fastened securely and tighten connections- by **HAND** only.

STEP 4

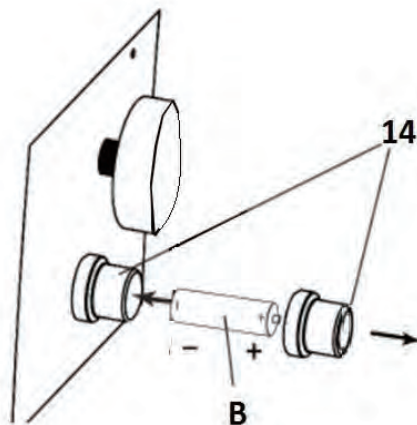

4. Remove the Electronic Igniter Cap(14) on the electronic Igniter(14) by unscrewing and slide the Battery(B) into the battery slot(14). Make sure the positive side of the Battery(B) faces outwards. Screw the Electronic Igniter Cap(14) over the battery, tightly.

STEP 5

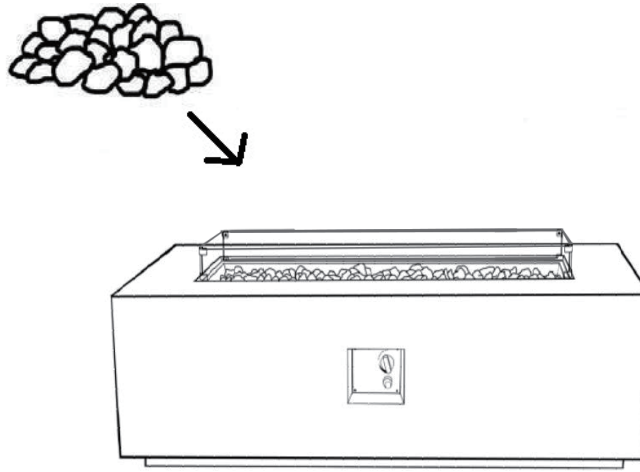

Subject to your preference, you may pour glass rocks over the Burner.

The Guard **MUST NOT BE BLOCKED**. Refer to guidance below:

Do not place more than 1/4 inch depth of glass rock above the burner holes. Doing so will suffocate the flame.

Do not place more than 17.6 LB of glass rock above the burner holes. Doing so will suffocate the flame.

WARNING : Fire Table and LP-Cylinder must be at a minimum of 60 inches apart.



WARNING



Guard
DO NOT PLACE LAVA ROCKS ON THE
GURARD.KEEP GUARD CLEAR.

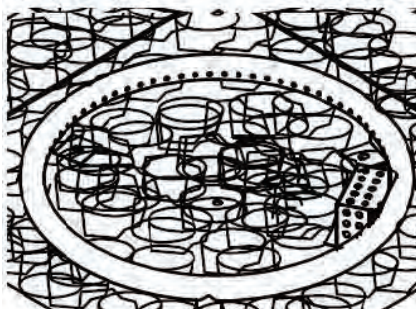

CORRECT

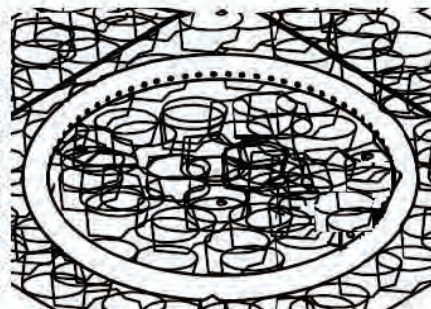

INCORRECT

To ensure proper function,the Guard (01) on the Burner (08) should never have glass rock (A) covered over it.

Part I.

SAFETY INFORMATION- OPERATIONS

Before performing a leak test, be sure:

- 1.) DO NOT press the Igniter.**
- 2.) You are in a spacious outdoor area.**

Connect the Propane Gas tank to the Regulator(12/19) and turn the Valve(22) on the unit to the “OFF” position.

Brush soap and water mixture onto all connections.

Turn the gas supply on; if extra large bubbles form on any connection there may be a leak. If you smell gas or a leak is discovered, IMMEDIATELY turn the gas valve off, disconnect Propane Gas tank. Do not use the appliance until the leak is repaired.

Inspect the Gas Hose(12) before using the Fire Table.

If there are signs of wear or abrasion on the hose, you must replace the Gas Hose(12). The Gas Hose must be supplied directly by manufacturer.

Wait 10 minutes after extinguishing flame prior to replacing a lid(if applicable) or protective cover onto the Fire Table.

Part J.

**SAFETY INFORMATION USING
YOUR FIRE TABLE**

Before each use, inspect the Gas Hose(12). Replace Gas Hose(12) if there are any signs of cutting, wear or abrasion.

Before you light your Fire Table, please do the following :

1. Make sure the Control Knob(13) is in the “OFF” position.

2. Open the Door(07)(if the unit has a door) and slowly open the Valve(22) on the Propane Gas Tank by turning the Control Knob(13) counterclockwise

3. Close the Door(07) on the Main Frame(06) of the Fire Table.

4. Push and hold the Electronic Igniter(14) to create sparks within the electrode continue to hold.

5. Push in the Control Knob(13) and turn to the “LOW” position. Keep holding down the Control Knob(13) to allow gas to flow for 15 seconds.

6. If ignition doesn't occur within a few seconds release the Control Knob(13) and rotate to the “OFF” position. Wait for 5 minutes for gas to clear and then repeat the above lighting instructions.

7. Once the Fire Table is lit, the flame intensity may be controlled by turning the Control Knob (13) between the “LOW” and “HIGH” positions.



2 inches to 10 inches.

8. Observe flame height when lit :

- 1) Flame color should be yellow/blue.
- 2) Flame height burns at 2-10 inches high.

Part K.	SAFETY INFORMATION : SHUTTING DOWN YOUR FIRE TABLE /COLUMN
----------------	---

To Shut Down your Fire Table, please do the following:

1. Turn Control Knob(13) clockwise to the “OFF” position.

2. Close the Cylinder Valve(21)on the Propane Gas tank if you DO NOT intend to use it for a long time.

Part L.	MAINTENANCE- FIRE TABLE
----------------	--------------------------------

- Before performing any maintenance work, ensure the Control Knob(13) is in the "OFF"position and always disconnect Propane Gas tank.
- Keep the Fire Table free and clear from all combustible materials.
- Visually inspect Burner(08) for obstructions and keep tank enclosure free and clear from debris.
- Use a soft brush to get rid of the mild stains, loose dirt and soil after the burner and pumice stones/lava rocks are completely cooled down.
Wipe down with a soft cloth.
- Harsh weather conditions may cause stubborn stains, discoloration and possibly rust pitting.
- If storing this unit inside, disconnect the Propane Gas tank from the Gas Valve(22).
Leave the gas tank outside of your premises.
- Not using manufacturer approved or supplied parts/accessories may result in a defective condition and shall void the warranty of this Fire Table
- Before performing any maintenance work, always :
 - 1) Ensure Control Knob(13) is in'OFF' position
 - 2) Disconnect Propane Gas tank
- Keep the Fire Table free and clear from all combustible materials.
- Visually inspect Burner(08) for obstructions and keep tank enclosure free and clear from debris.
- Place lid (if applicable) and Protective Cover(E) on the Fire Table when not in use.

Part M.

MAINTENANCE : FIRE TABLE SURFACE CARE

• Our Fire Table material has been sealed with a treatment that prevents staining and moisture absorption, and for product longevity this Fire Table would still require proper care and maintenance to ensure the integrity of the surface.

• Please see below for recommendations on maintaining your Fire Table surface for years of extended use :

• Clean any spills immediately to prevent permanent stains or damage to your Fire Table

Use a dry cloth to absorb liquid spills to keep the liquid from spreading.

To prevent the absorption of any liquid into the surfaces, immediately clean the area(s) affected.

• How to Clean your Fire Table surface(s) :

Mix a mild dish soap into warm clean water, use a soft, clean cloth or sponge.

Then proceed to remove surface dirt, stains or mild spills.

Rinse all soap solution off from the surfaces with a damp cloth.

Dry off completely with a dry cloth to avoid water spots/water marks.

Regularly cleaning the Fire Table surface will aid in a longer lasting product.

• **DO NOT** use petroleum-based or abrasive cleaning products.

DO NOT use any harsh brushes/rough sponges when cleaning the Fire Table surface(s).

• **DO NOT** place any food on the surface(s) of the Fire Table.

DO NOT eat from the surface(s) of the Fire Table surface.

• Fire Table surface should be covered at all times when not in use.

Cover your product with an outdoor Protective Cover(E) when not in use to protect it from the elements.

Store your product indoors during winter months, leave the gas tank outside.

Avoiding extreme cold temperatures, as extreme cold temperatures may cause cracking of the table top.

Troubleshooting

Problem: Burner will not light using igniter

Please review the Helpful Tips on page 15 for common fixes to this problem.

Possible Cause 1: Electrode and burners are wet.

-Wipe dry with cloth.

Possible Cause 2: Igniter battery is dead or backwards.

-Check that the AA battery is inserted correctly in the igniter (see page 10) or replace the battery. Make sure the plastic wrap on the battery has been removed.

Possible Cause 3: Igniter Pin cracked or broken - sparks a crack.

-Please contact Living source to request the parts.

Possible Cause 4: Residue on Igniter Pin.

-Check for residue on the igniter pin or Thermocouple. If dirty,thoroughly clean the area.

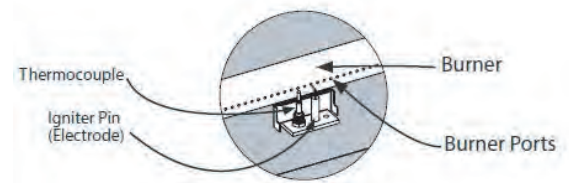

Problem: Burner will not light with match

Possible Cause 1: No Gas Flow

-Check if the LP gas tank is empty. If empty, replace and refill. If the propane tank is not empty, refer to **Problem: Sudden drop in gas flow** on the following page.

Possible Cause 2: Coupling nut and regulator not fully connected.

-Turn the coupling nut about one half to three fourths a turn, until you feel a solid stop. Do not use tools, tighten by hand only.

Possible Cause 3: Obstruction of gas flow.

- Check for bent or kinked hose.

Possible Cause 4: Spider webs or insect nest in the venturi.

- Clean the venturi.

Possible Cause 5: Burner ports clogged or blocked.

-Reference **Problem: Irregular flame pattern** on the following page. Clean the burner ports as described there.

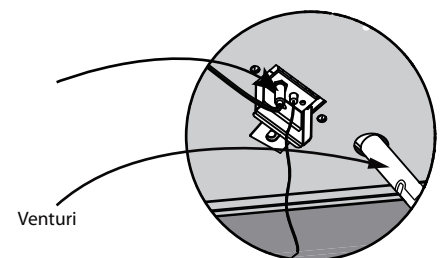

Problem: The fire table emits a lot of black smoke when in use

Possible Cause 1: Hose from gas fire table is pinched.

-Make sure the hose is not pinched between the fire table and the source of the gas.

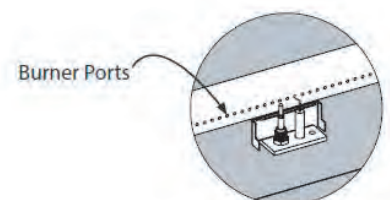

Possible Cause 2: Flame is being obstructed at burner ports.

- Make sure that the gas ports on the burner are free of any lava rocks/fire glass so that the flame can flow naturally.
- Clear out the mixing chamber located before the Venturi.

Possible Cause 3: Mixing chamber of the burn tube is blocked or obstructed.

Problem: Sudden drop in gas flow, or a reduced flame height

Possible Cause 1: Out of Gas.

- Check for gas in the LP gas tank.

Possible Cause 2: Excess flow safety device may have been activated.

- Turn control knob to **OFF**, wait 30 seconds and light outdoor fire table. if flames are still too low, reset the excessive flow safety device by turning off the control knob and LP gas tank valve. Disconnect regulator. Turn burner control knob to **HIGH**. Wait at least 5 minutes. Turn burner control knob off. Reconnect regulator and perform a leak check at tank connection. Turn LP gas tank valve on slowly, wait 30 seconds and then light outdoor fire table.

Problem: Irregular flame pattern , flame does not run the full length of the burner

Possible Cause: Burner ports are clogged or blocked.

- Clean burner ports. Do this by inserting a paperclip into each of the burner ports to ensure they are not clogged.
WARNING: Make sure burner is not on, and has had sufficient time to cool before touching it.

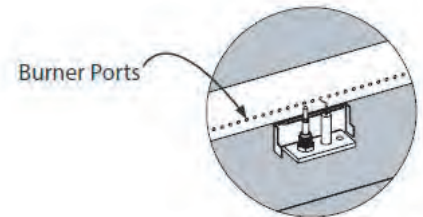

Problem: Flame blow out

Possible Cause 1: High or gusting winds.

- Increase flame to **HIGH** setting.

Possible Cause 2: Low on LP gas.

- Replace or refill LP gas tank.

Possible Cause 3: Excess flow valve tripped.

- Refer to **Problem: Sudden drop in gas flow**

Problem: Flame seems to lose heat when burning in cold weather - temperature below 50°F

Possible Cause 1: Ice has built up on the outside of the LP gas tank because the vaporization process is too low.

- Turn the control knob and the LP gas tank to **OFF**. Replace with a spare LP gas tank and resume burning. Store the spare LP gas tank in a well ventilated area, away from children.

WARRANTY

KEEP THIS WARRANTY

Model _____

Serial No. _____

Date Purchased _____

Keep receipt for warranty verification.

REGISTER YOUR PRODUCT AT WWW.BLUEGRASSLIVING.COM

BLUEGRASS LIVING LIMITED WARRANTIES

New Products

Standard Warranty: Bluegrass Living warrants this new product and any parts thereof to be free from defects in material and workmanship for a period of one (1) year from the date of first purchase from an authorized dealer provided the product has been installed, maintained and operated in accordance with Bluegrass Living's warnings and instructions.

For products purchased for commercial, industrial or rental usage, this warranty is limited to 90 days from the date of first purchase.

Factory Reconditioned Products

Limited Warranty: Bluegrass Living warrants factory reconditioned products and any parts thereof to be free from defects in material and workmanship for a period 30 days from the date of first purchase from an authorized dealer provided the product has been installed, maintained and operated in accordance with Bluegrass Living's warnings and instructions. No return will be authorized. Parts will be provided to repair the product.

Terms Common to All Warranties

The following terms apply to all of the above warranties:

Always specify model number and serial number when contacting the manufacturer. To make a claim under this warranty, the bill of sale or other proof of purchase must be presented.

This warranty is extended only to the original retail purchaser when purchased from an authorized dealer, and only when installed by a qualified installer in accordance with all local codes and instructions furnished with this product.

This warranty covers the cost of part(s) required to restore this product to proper operating condition and an allowance for labor when provided by a Bluegrass Living Authorized Service Center or a provider approved by Bluegrass Living. Warranty parts must be obtained through authorized dealers of this product and/or Bluegrass Living who will provide original factory replacement parts. Failure to use original factory replacement parts will void this warranty.

Traveling, handling, transportation, diagnostic, material, labor and incidental costs associated with warranty repairs, unless expressly covered by this warranty, are not reimbursable under this warranty and are the responsibility of the owner.

Excluded from this warranty are products or parts that fail or become damaged due to misuse, accidents, improper installation, lack of proper maintenance, tampering or alteration(s).

This is Bluegrass Living's exclusive warranty, and to the full extent allowed by law; this express warranty excludes any and all other warranties, express or implied, written or verbal and limits the duration of any and all implied warranties, including warranties of merchantability and fitness for a particular purpose to one (1) year on new products and 30 days on factory reconditioned products from the date of first purchase.

Bluegrass Living makes no other warranties regarding this product.

Bluegrass Living's liability is limited to the purchase price of the product and Bluegrass Living shall not be liable for any other damages whatsoever under any circumstances including direct, indirect, incidental, or consequential damages.

Some states do not allow limitations on how long an implied warranty lasts or the exclusion or limitation of incidental or consequential damages, so the above limitation or exclusion may not apply to you.

This warranty gives you specific legal rights, and you may also have other rights which vary from state to state.



Bluegrass Living, Inc.
2800 Griffin Drive
Bowling Green, KY 42101
1-866-762-4050

200558-07A
Rev. A
06/20