

LOST *River*

VENT-FREE GAS LOGS INSTALLATION INSTRUCTIONS

MODELS PCILVFD18-(1,2) & PCILVFD24-(1,2)

For Use With
PCILVFD(18,24)H, PCILVFD(18,24)RT and PCILVFD(18,24)T Chassis

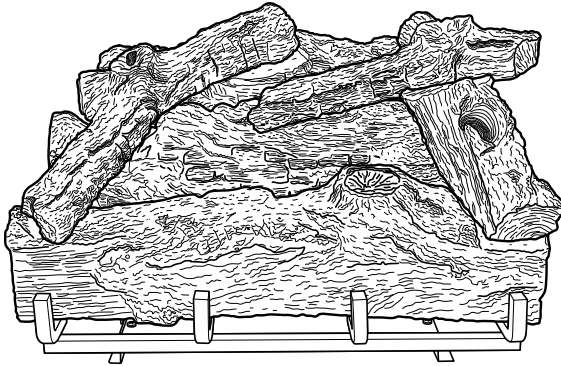

PCILVFD18-1 Shown



Questions, problems, missing parts? Before returning to your retailer, call our customer service department at 1-866-573-0674, 7:30 am - 4:15 pm CST, Monday through Friday or email customerservice@usaprocom.com

TABLE OF CONTENTS

Installation Guidelines	2
Installing Logs.....	3
Warranty	8

SAVE THIS BOOK

INSTALLER: Leave this manual with the appliance.
CONSUMER: Retain this manual for future reference.

This log set has been tested and approved to ANSI Z21.11.2 standard for Unvented Heaters and also complies with ANSI Z21.60 Decorative Vented Appliances for Solid Fuel Burning Fireplaces. State and local codes in some areas prohibit the use of vent-free heaters. Check your state or local codes.

INSTALLATION GUIDELINES

Proper Log Placement

Log placement is critical to proper burner performance. Logs must be correctly positioned onto the burner. The illustrations in this manual show the proper position for logs on this set. Owners need to be shown proper log placement and instructed not to move the logs.

Logs must fit firmly onto the burner when positioned as shown in the illustrations. Malformed logs must be replaced.

Proper Primary Airflow into the Burner

For proper burner operation and flame appearance, the flow of primary air into the venturi tube, located on the rear of the burner, must not be reduced. This flow of air is reduced if dirt, lint or other obstructions build-up around or inside the venturi. Any obstruction in the venturi tube area must be removed. The flow of air into the venturi is also reduced if the gas orifice isn't centered in the venturi inlet and/or is not aligned with the venturi. Any misalignment of the burner orifice may be corrected by bending the shutter cap holding the orifice to the inlet or the venturi tube.

Ceiling Fans, Portable Fans or Logs Installed Near Cold Air Returns

Ceiling fans or oscillating floor type fans need to be monitored during the operation of vent-free logs. If the air blows directly into the flame causing it to impinge on the log set, or firebox, it should be turned off or redirected. Ceiling fans could be reversed to possibly eliminate flame impingement, and the floor fan could be redirected. Upon installation, be aware of any cold air returns or vents in the proximity of the log set. Any draft created around a vent-free log set can cause the flame to impinge on the log and create a sooting situation.

Candles

Avoid the use of scented or decorative candles while the log set is in operation. Candles produce a residue in the air that creates a soot like substance. Burning candles while the log set is operating magnifies the problem. It should be noted that candles, in general, produce soot. The amount of time burned and the quantity of candles burned will determine the amount of soot produced and deposited.

Proper Log Set Operation

Properly installed and properly maintained log sets do not deposit soot on the logs. If users see soot appear on a log, call for service. Do not continue to operate the log set.

INSTALLATION GUIDELINES

Sunken Fireplace

If installing this unit into a sunken fireplace, you must raise the floor to insure adequate airflow and guard against sooting. Raise fireplace floor using a noncombustible material, which is secure.

Glass Doors

Make sure that glass doors are open during all operations of the log set. The opening of

the glass door frame should be the dimension used for the minimum front opening of the firebox.

Wood Burning Fireplaces

The interior of the firebox and the chimney should be cleaned and free of all creosote before installing a gas burning log set. Creosote will soften when heated and can drop on the log set causing odors and possibly sooting.

INSTALLING LOGS

⚠ WARNING: Failure to position the parts in accordance with these diagrams or failure to use only parts specifically approved with this heater may result in property damage or personal injury.

⚠ CAUTION: After installation and periodically thereafter, check to ensure that no yellow flame comes in contact with any log. With the heater set to High, check to see if yellow flames contact any log. If so, reposition logs according to the log installation instructions in this manual. Yellow flames contacting logs will create soot.

Do not attempt to use this heater if any logs are missing or damaged.

Inspect the contents of this log set to insure there are no missing or damaged logs. If any logs are found missing or damaged contact customer support for replacements.

It is very important to install the logs exactly as instructed. Do not modify logs. Use only logs supplied with heater.

Each log is marked with a number. This number will help you to identify the logs when installing.

After installing logs, add decorative cinders around the grate base, do not place any decorative cinders on logs or burner.

NOTE: During initial operation of a new heater, burning logs will give off a paper-burning smell. Orange flame will also be present. Open damper or window to vent smell. This will only last a few hours.

Each of the following pages contains a list of replaceable parts for each log set. When ordering parts, contact authorized dealers of this product or call customer service at 1-866-573-0674. When calling have you model and serial numbers available.

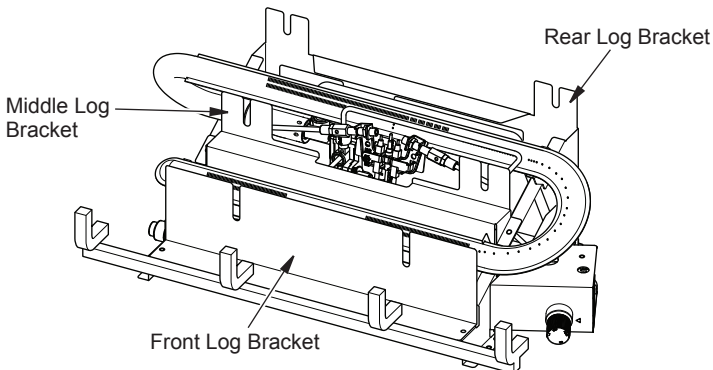

PCILVFD18RT Chassis Shown. Actual model may vary.

INSTALLING LOGS

MODEL PCILVFD18-1

1. Place log #1 onto rear log bracket.
2. Place log #2 onto middle log bracket.
3. Place log #3 onto front log bracket.
4. Place log #4 onto the left of logs #1, #2 and #3.
5. Place log #5 onto logs #2 and #3.
6. Place log #6 onto logs #1 and #2.

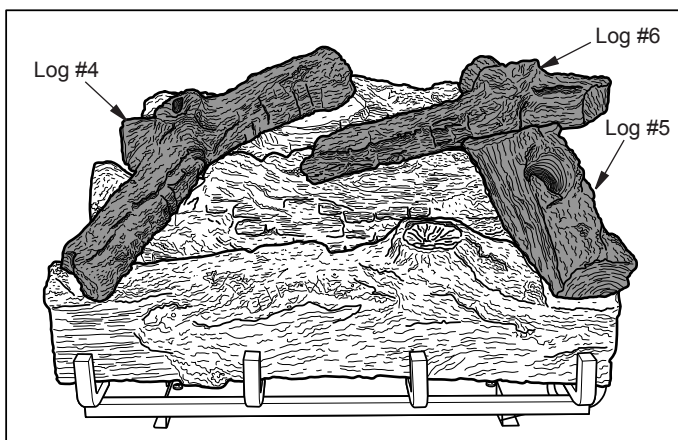
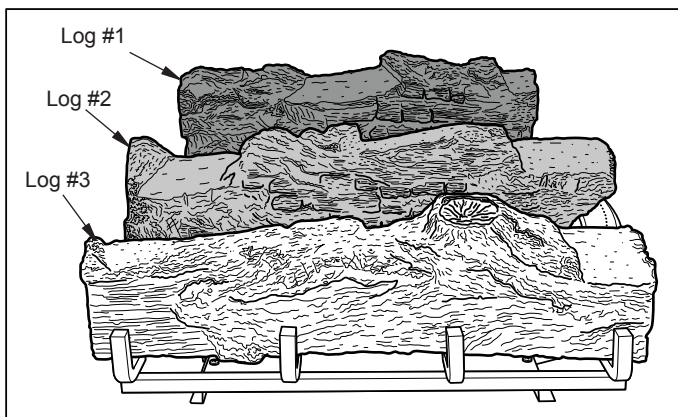

ITEM	PCILVFD18-1	DESCRIPTION	QTY
	161940-01	Traditional Log Set	1
1	161941-01	Bottom Rear Log	1
2	161942-01	Bottom Middle Log	1
3	161943-01	Bottom Front Log	1
4	161944-01	Top Left Log	1
5	161946-01	Top Right Log	1
6	161945-01	Top Middle Log	1

INSTALLING LOGS

MODEL PCILVFD18-2

1. Place log #1 onto rear log bracket.
2. Place log #2 onto middle log bracket.
3. Place logs #3 and #4 onto front log bracket.
4. Place log #5 onto the left of logs #1, #2 and #3.
5. Place log #7 onto logs #1 and #2.
6. Place log #6 onto logs #2 and #4.
5. Place log #7 onto logs #1 and #2.

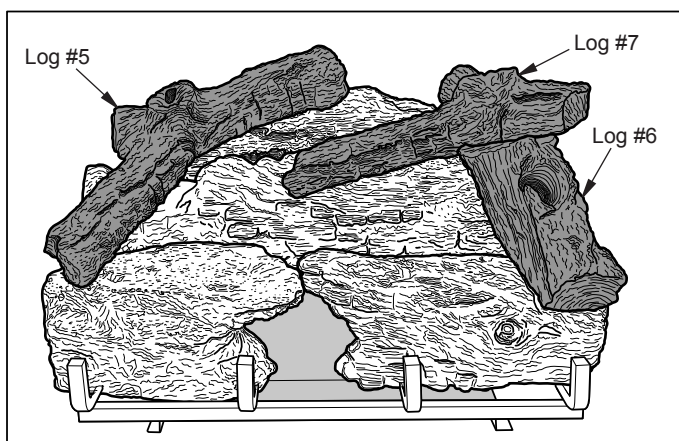
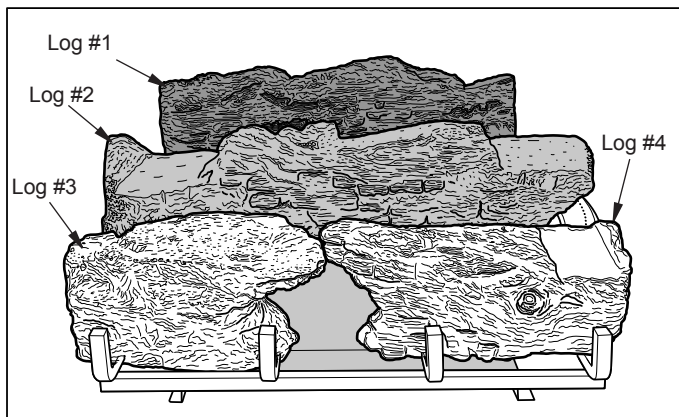

ITEM	PCILVFD18-2	DESCRIPTION	QTY
	161947-01	Split Log Set	1
1	161948-01	Bottom Rear Log	1
2	161949-01	Bottom Middle Log	1
3	161950-01	Bottom Front Left Log	1
4	161951-01	Bottom Front Right Log	1
5	161944-01	Top Left Log	1
6	161946-01	Top Right Log	1
7	161945-01	Top Middle Log	1

INSTALLING LOGS

MODEL PCILVFD24-1

1. Place log #1 onto rear log bracket.
2. Place log #2 onto middle log bracket.
3. Place log #3 onto front log bracket.
4. Place log #4 onto the left of logs #1, #2 and #3.
5. Place log #5 onto logs #2 and #3.
6. Place log #6 onto logs #2 and #3.
7. Place log #7 onto logs #1 and #2.

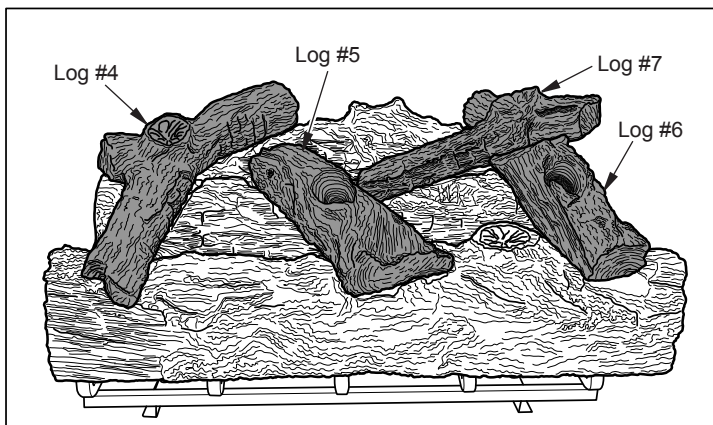
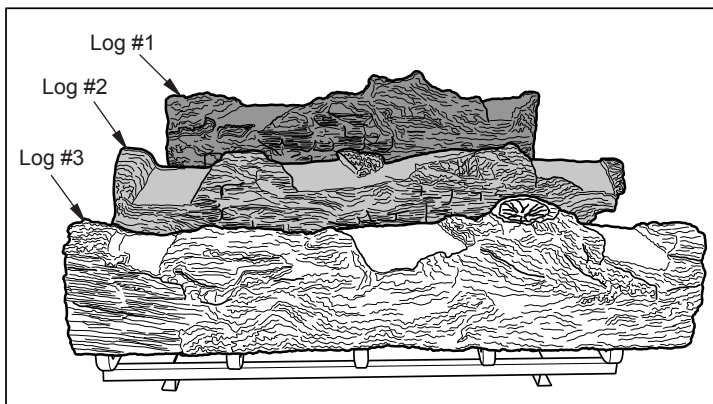

ITEM	PCILVFD24-1	DESCRIPTION	QTY
	161952-01	Traditional Log Set	1
1	161953-01	Bottom Rear Log	1
2	161954-01	Bottom Middle Log	1
3	161955-01	Bottom Front Log	1
4	161944-01	Top Left Log	1
5	161956-01	Top Middle Log	1
6	161945-01	Top Right Log	1
7	161946-01	Top Crossover Log	1

INSTALLING LOGS

MODEL PCILVFD24-2

1. Place log #1 onto rear log bracket.
2. Place log #2 onto middle log bracket.
3. Place logs #3 and #4 onto front log bracket.
4. Place log #5 onto the left of logs #1, #2 and #3.
5. Place log #6 onto logs #2, #3 and #4.
6. Place log #7 onto logs #2 and #4.
7. Place log #8 onto logs #1 and #2.

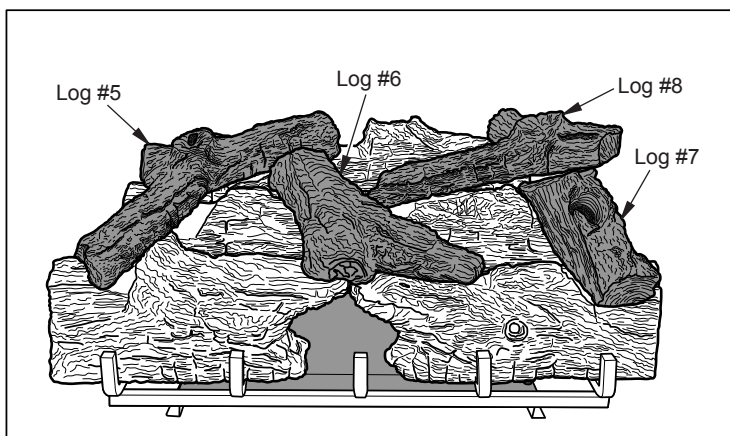
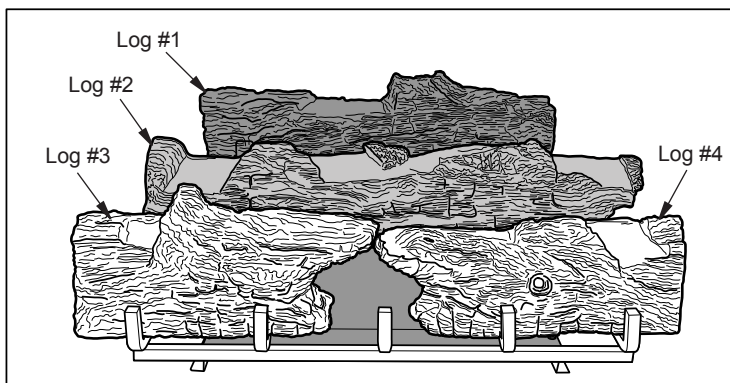

ITEM	PCILVFD24-2	DESCRIPTION	QTY
	161957-01	Split Log Set	1
1	161958-01	Bottom Rear Log	1
2	161959-01	Bottom Middle Log	1
3	161960-01	Bottom Front Left Log	1
4	161961-01	Bottom Front Right Log	1
5	161944-01	Top Left Log	1
6	161962-01	Top Middle Log	1
7	161945-01	Top Right Log	1
8	161946-01	Top Crossover Log	1

WARRANTY

KEEP THIS WARRANTY

Model _____

Serial No. _____

Date Purchased _____

Keep receipt for warranty verification.

REGISTER YOUR PRODUCT AT WWW.USAPROCOM.COM

IMPORTANT: We urge you to register your product within 10 days of date of installation, complete with entire serial number which can be found on the rating plate. Please fill out the warranty information above for your personal records. Retain this manual for future reference.

Always specify model and serial numbers when communicating with customer service.

We reserve the right to amend these specifications at any time without notice. The only warranty applicable is our standard written warranty. We make no other warranty, expressed or implied.

LIMITED WARRANTY

ProCom Heating, Inc. warrants this product to be free from defects in materials and components for ONE (1) year from the date of first purchase, provided that the product has been properly installed by a qualified installer in accordance with all local codes and instructions furnished with the unit, operated and maintained in accordance with all applicable instructions. To make a claim under this warranty, the Bill of Sale or canceled check must be presented.

RESPONSIBILITY OF OWNER

This warranty is extended only to the original retail purchaser. This warranty covers the cost of part(s) required to restore this heater to proper operating condition. Warranty part(s) MUST be obtained through ProCom Heating, Inc. who will provide original factory replacement parts. Failure to use original factory replacement parts voids this warranty.

IMPORTANT: The heater MUST be installed by a qualified installer in accordance with all local codes and instructions furnished with the unit or the warranty is voided.

WHAT IS NOT COVERED

This warranty does not apply to parts that are not in original condition because of normal wear and tear or parts that fail or become damaged as a result of misuse, accidents, lack of proper maintenance or defects caused by improper installation. Travel, diagnostic cost, labor, transportation and any and all such other costs related to repairing a defective heater will be the responsibility of the owner.

TO THE FULL EXTENT ALLOWED BY THE LAW OF THE JURISDICTION THAT GOVERNS THE SALE OF THE PRODUCT, THIS EXPRESS WARRANTY EXCLUDES ANY AND ALL OTHER EXPRESSED WARRANTIES AND LIMITS THE DURATION OF ANY AND ALL IMPLIED WARRANTIES. INCLUDING WARRANTIES OF MERCHANTABILITY AND FITNESS FOR A PARTICULAR PURPOSE TO ONE (1) YEAR ON ALL COMPONENTS FROM THE DATE OF FIRST PURCHASE. PROCOM HEATING, INC.'S LIABILITY IS HEREBY LIMITED TO THE PURCHASE PRICE OF THE PRODUCT AND PROCOM HEATING, INC. SHALL NOT BE LIABLE FOR ANY OTHER DAMAGES WHATSOEVER INCLUDING INDIRECT, INCIDENTAL OR CONSEQUENTIAL DAMAGES.

Some states do not allow a limitation on how long an implied warranty lasts or an exclusion or limitation of accidental or consequential damages, the above limitation on implied warranties, or exclusion or limitation on damages may not apply to you.

This warranty gives you specific legal right, and you may also have other rights that vary from state to state.



ProCom Heating, Inc.
Bowling Green, KY 42101
www.usaprocom.com
1-866-573-0674

200359-01
Rev. A
10/16