



VENT-FREE GAS LOGS INSTALLATION INSTRUCTIONS

**MODELS
FVFLC18-1 & FVFLC18-2
For Use With FDLR18-1 Chassis**



FVFLC18-1 Shown



Questions, problems, missing parts? Before returning to your retailer, call our customer service department at 1-855-607-6557, 8:00 am - 4:30 pm CST, Monday through Friday or email contact@factorybuysdirect.com

TABLE OF CONTENTS

Safety	3
Local Codes.....	4
Qualified Installing Agency	4
Installation Guidelines	5
Installing Logs.....	6
Parts	7
Warranty	8

SAVE THIS BOOK

<p>INSTALLER: Leave this manual with the appliance. CONSUMER: Retain this manual for future reference.</p>
--

<p>This log set has been tested and approved to ANSI Z21.11.2 standard for Unvented Heaters and also complies with ANSI Z21.60 Decorative Vented Appliances for Solid Fuel Burning Fireplaces. State and local codes in some areas prohibit the use of vent-free heaters. Check your state or local codes.</p>

INSTALLATION GUIDELINES

Proper Log Placement

Log placement is critical to proper burner performance. Logs must be correctly positioned onto the burner. The illustrations in this manual show the proper pinned position for logs on this set. Owners need to be shown proper log placement and instructed not to move the logs.

Logs must fit firmly onto the burner when positioned as shown in the illustrations. Malformed logs or logs with sloppy pin holes must be replaced.

Proper Primary Airflow into the Burner

For proper burner operation and flame appearance, the flow of primary air into the venturi tube, located on the rear of the burner, must not be reduced. This flow of air is reduced if dirt, lint or other obstructions build-up around or inside the venturi. Any obstruction in the venturi tube area must be removed. The flow of air into the venturi is also reduced if the gas orifice isn't centered in the venturi inlet and/or is not aligned with the venturi. Any misalignment of the burner orifice may be corrected by bending the shutter cap holding the orifice to the inlet or the venturi tube.

Ceiling Fans, Portable Fans or Logs Installed Near Cold Air Returns

Ceiling fans or oscillating floor type fans need to be monitored during the operation of vent-free logs. If the air blows directly into the flame causing it to impinge on the log set, or firebox, it should be turned off or redirected. Ceiling fans could be reversed to possibly eliminate flame impingement, and the floor fan could be redirected. Upon installation, be aware of any cold air returns or vents in the proximity of the log set. Any draft created around a vent-free log set can cause the flame to impinge on the log and create a sooting situation.

Candles

Avoid the use of scented or decorative candles while the log set is in operation. Candles produce a residue in the air that creates a soot like substance. Burning candles while the log set is operating magnifies the problem. It should be noted that candles, in general, produce soot. The amount of time burned and the quantity of candles burned will determine the amount of soot produced and deposited.

Proper Log Set Operation

Properly installed and properly maintained log sets do not deposit soot on the logs. If users see soot appear on a log, call for service. Do not continue to operate the log set.

Sunken Fireplace

If installing this unit into a sunken fireplace, you must raise the floor to insure adequate airflow and guard against sooting. Raise fireplace floor using a noncombustible material, which is secure.

Glass Doors

Make sure that glass doors are open during all operations of the log set. The opening of the glass door frame should be the dimension used for the minimum front opening of the firebox.

Wood Burning Fireplaces

The interior of the firebox and the chimney should be cleaned and free of all creosote before installing a gas burning log set. Creosote will soften when heated and can drop on the log set causing odors and possibly sooting.

INSTALLING LOGS

⚠ WARNING: Failure to position the parts in accordance with these diagrams or failure to use only parts specifically approved with this heater may result in property damage or personal injury.

⚠ CAUTION: After installation and periodically thereafter, check to ensure that no yellow flame comes in contact with any log. With the heater set to High, check to see if yellow flames contact any log. If so, reposition logs according to the log installation instructions in this manual. Yellow flames contacting logs will create soot.

It is very important to install the logs exactly as instructed. Do not modify logs. Use only logs supplied with heater.

Each log is marked with a number. This number will help you to identify the logs when installing. After installing logs, add decorative cinders around the grate base, do not place any decorative cinders on logs or burner.

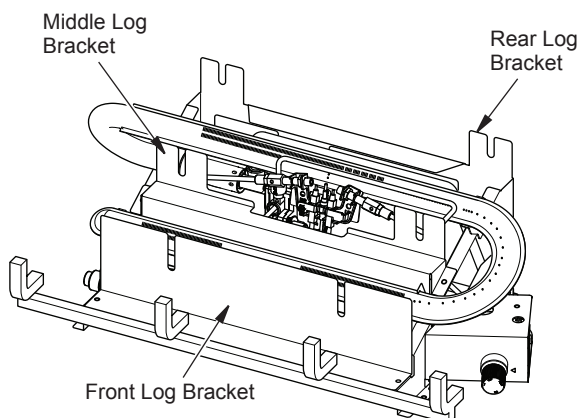

INSTALLING LOGS

MODEL FVFLC18-1

1. Insert log #1 into slots in rear log bracket.
2. Insert log #2 into slots in middle log bracket.
3. Insert logs #3 and #4 into slots in front log bracket.
4. Place log #5 onto logs #1 and #3.
5. Place log #6 onto logs #1 and #4.
6. Place log #7 onto logs #3 and #5.
7. Place log #8 onto log #4.

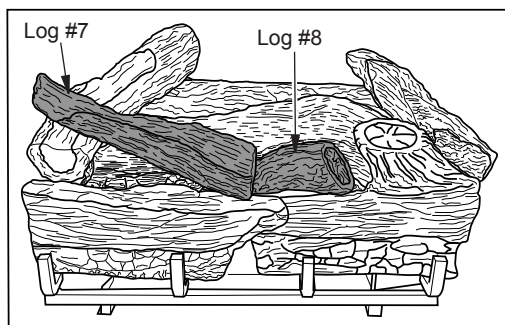
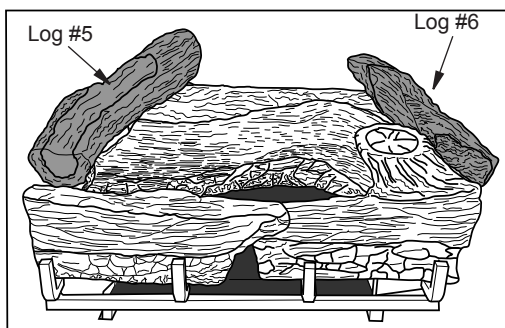
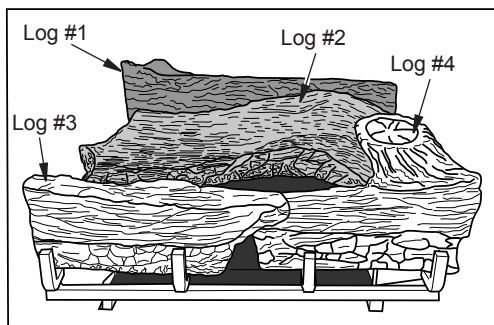

INSTALLING LOGS

MODEL FVFLC18-2

1. Insert log #1 into slots in rear log bracket.
2. Insert log #2 into slots in middle log bracket.
3. Insert log #3 into slots in front log bracket.
4. Place log #4 on over the left side of logs #1, #2 and #3.
5. Place log #5 on over the right side of logs #1, #2 and #3.
6. Place log #6 onto logs #2 and #4 as shown below.
7. Place log #7 onto logs #3 and #5 as shown below.

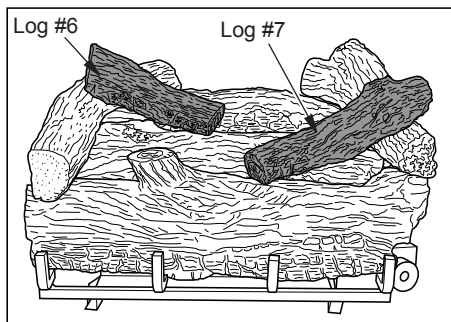
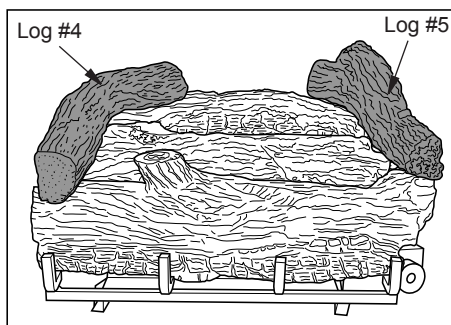
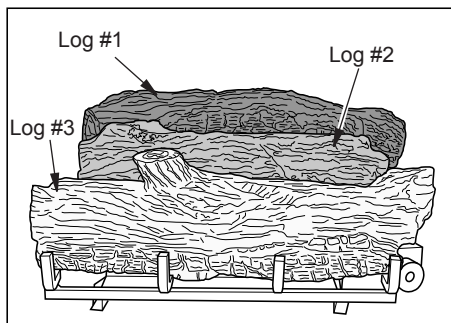

PARTS

MODELS FVFLC18-1 AND FVFLC18-2

ITEM	FVFLC18-1	FVFLC18-2	DESCRIPTION	QTY
1	FVFLC18-1-1	FVFLC18-2-1	Log 1	1
2	FVFLC18-1-2	FVFLC18-2-2	Log 2	1
3	FVFLC18-1-3	FVFLC18-2-3	Log 3	1
4	FVFLC18-1-4	FVFLC18-2-4	Log 4	1
5	FVFLC18-1-5	FVFLC18-2-5	Log 5	1
6	FVFLC18-1-6	FVFLC18-2-6	Log 6	1
7	FVFLC18-1-7	FVFLC18-2-7	Log 7	1
8	FVFLC18-1-8	---	Log 8	1

This list contains replaceable parts used in your heater. When ordering parts, contact authorized dealers of this product or call customer service at 1-855-607-6557. When calling have you model and serial numbers available.



Factory Buys Direct.com
2701 Industrial Drive
Bowling Green, KY 42101
1-855-607-6557

200235-01
Rev. B
03/19