



NATURAL GAS LOG VENTED DECORATIVE APPLIANCE



**MODELS
WAN18LA
WAN24LA**



⚠ WARNING: If the information in this manual is not followed exactly, a fire or explosion may result causing property damage, personal injury or loss of life.

- Do not store or use gasoline or other flammable vapors and liquids in the vicinity of this or any other appliance.
- **WHAT TO DO IF YOU SMELL GAS**
 - Do not try to light any appliance.
 - Do not touch any electrical switch; do not use any phone in your building.
 - Immediately call your gas supplier from a neighbor's phone. Follow the gas supplier's instructions.
 - If you cannot reach your gas supplier, call the fire department.
- Installation and service must be performed by a qualified installer, service agency or the gas supplier.

INSTALLER: Leave this manual with the appliance.
CONSUMER: Retain this manual for future reference.



Questions, problems, missing parts? Before returning to your retailer, call our customer service department at 1-866-573-0674, 8:00 am - 4:30 pm CST, Monday through Friday or email customerservice@usaprocom.com

TABLE OF CONTENTS

Specifications	3	Operation.....	14
Safety	3	Care and Maintenance	15
Product Features	5	Accessories	15
Local Codes.....	5	Troubleshooting.....	16
Unpacking.....	5	Replacement Parts	17
Air For Combustion and Ventilation.....	6	Parts	18
Installation	6	Warranty	20

SAVE THIS BOOK

This is a gas-fired appliance. It uses air (oxygen) from the room in which it is installed. Provisions for adequate combustion and ventilation air must be provided. Refer to *Air For Combustion and Ventilation* section on page 6 of this manual.

⚠ WARNING: Improper installation, adjustment, alteration, service or maintenance can cause injury or property damage. Refer to this manual for correct installation and operational procedures. For assistance or additional information consult a qualified installer, service agency or the gas supplier.

⚠ WARNING: This appliance is for installation only in a solid-fuel burning masonry or factory-built fireplace, constructed of noncombustible material, and connected to a working flue. (See page 3 for minimum flue opening).

This appliance is convertible for use with propane/LP gas by using the ON/OFF SAFETY PILOT VALVE KIT (see *Accessories*, page 15).

This appliance may be installed in an aftermarket,* permanently located, manufactured (mobile) home, where not prohibited by local codes.

* Aftermarket: Completion of sale, not for purpose of resale, from the manufacturer.

SPECIFICATIONS

Note: This vented appliance must be installed only in a solid-fuel burning fireplace with a working flue and constructed of noncombustible material.

The charts indicate technical information regarding the installation of your gas log set.

Please make sure that all of the specifications shown are applicable before installation is attempted.

The fireplace must include a working flue and venting system with the minimum openings shown as below.

Model	WAN18LA	WAN24LA
Gas Type	Natural	Natural
BTU Input*	45,000 BTU/Hr	55,000 BTU/Hr
Minimum Vent Opening	8" Diameter	8" Diameter
Burner Orifice (Propane/LP)**	273 (205)	304 (225)

* Btu/Hr Rating is the same when unit is converted to Propane/LP gas.

** Number is printed on orifice.

FUEL INLET PRESSURE SPECIFICATIONS (W.C.)		
Natural Gas	Minimum 5.5" W.C.	Maximum 10.5" W.C.
Propane/LP Gas*	Minimum 11" W.C.	Maximum 13" W.C.

* For use if unit is converted to Propane/LP gas.

MINIMUM FIREBOX SIZES				
Model	Front Width	Back Width *	Depth	Height
WAN18LA	26"	18"	15"	18"
WAN24LA	32"	24"	15"	18"

* At depth indicated.

SAFETY

IMPORTANT: Read this owner's manual carefully and completely before trying to assemble, operate, or service this heater. Improper use of this heater can cause serious injury or death from burns, fire, explosion, electrical shock and carbon monoxide poisoning.

Only a qualified installer, service agent, or local gas supplier may install and service this product.

⚠ WARNING: Keep flue open when operating unit.

⚠ DANGER: Carbon monoxide poisoning may lead to death!

Carbon Monoxide Poisoning: Early signs of carbon monoxide poisoning resemble the flu, with headaches, dizziness or nausea. If you have these signs, the heater may not be working properly. Get fresh air at once! Have heater serviced. Some people are more affected by carbon monoxide than others. These include pregnant women, people with heart or lung disease or anemia, those under the influence of alcohol and those at high altitudes.

Natural Gas: Natural gas is odorless. An odor-making agent is added to the gas. The odor helps you detect a gas leak. However, the odor added to the gas can fade. Gas may be present even though no odor exists.

SAFETY

 **WARNING: Any change to this log set or its controls can be dangerous.**

1. This appliance, as supplied, is only for use with the type of gas indicated on the rating plate. This appliance is convertible for use with propane/LP, using the manual ON/OFF safety pilot valve kit.
2. If you smell gas:
 - Shut off gas supply
 - Do not try to light any appliance
 - Do not touch any electrical switches; do not use any phone in your building
 - Immediately call your gas supplier from a neighbor's phone. Follow the gas supplier's instructions
 - If you cannot reach your gas supplier, call the fire department
3. Never install the log set:
 - In a recreational vehicle
 - Where curtains, furniture, clothing, or other flammable objects are less than 42" from the front, top, or sides of the log set
 - In high traffic areas
 - In windy or drafty areas
4. Before installing in a solid fuel burning fireplace, the chimney flue and fire-box must be cleaned of soot, creosote, ashes and loose paint by a qualified chimney cleaner. Creosote will ignite if highly heated. Inspect chimney flue for damage.
5. You must operate this log set with a fireplace screen in place. Make sure fireplace screen is closed before running log set. If the fireplace has glass doors, they must remain OPEN while this log set is in operation.
6. This log set is designed to be smokeless. If logs ever appear to smoke, turn off appliance and call a qualified service person.
Note: During initial operation, slight smoking could occur due to log curing and the burning of manufacturing residues. You may wish to add more ventilation by opening a window.
7. To reduce the creation of soot, follow the instructions in Care and Maintenance, page 14.
8. Do not allow fans to blow directly into the fireplace. Avoid any drafts that alter burner flame patterns. Ceiling fans can create drafts that alter burner flame patterns. Altered burner patterns can increase sooting.
9. Do not use a blower insert, heat exchanger insert, or other accessory not approved for use with this log set.
10. This log set needs fresh, outside air ventilation to run properly. See the Air for Combustion and Ventilation, page 6.
11. Do not run log set
 - where flammable liquids or vapors are used or stored
 - under dusty conditions
12. Do not burn solid fuel in the fireplace after installing the log set. Do not use this log set to cook food or burn paper or other objects.
13. Log set becomes very hot when in use. Keep children and adults away from hot surface to avoid burns or clothing ignition. Log set will remain hot for a short time after shut-down. Allow surface to cool before touching.
14. Carefully supervise young children when they are in the room with log set.
15. Do not use appliance if any part has been exposed to or under water. Immediately call a qualified service technician to inspect the room appliance and to replace any part of the control system (if using control system) and any gas control which has been under water.
16. To help prevent breakage, new logs must go through the curing process (see Curing Logs, page 13).
17. Turn log set off and let cool before servicing, installing, or repairing. Only a qualified service person should install, service, or repair log set.

PRODUCT FEATURES

ON/OFF SAFETY PILOT VALVE KIT WITH PROPANE/LP CONVERSION

An optional on/off valve/safety pilot kit with a piezo ignitor is available for this appliance. This system requires no matches, batteries, or other sources to light. You must use this optional system for Propane/LP conversion.

LOCAL CODES

Install and use heater with care. Follow all local codes. In the absence of local codes, use the latest edition of *The National Fuel Gas Code, ANSI Z223.1/NFPA 54**.

*Available from:

American National Standards Institute, Inc.
1430 Broadway
New York, NY 10018
National Fire Protection Association, Inc.
1 Batterymarch Park
Quincy, MA 02269-9101

State of Massachusetts: The installation must be made by a licensed plumber or gas fitter in the Commonwealth of Massachusetts.

Sellers of unvented propane or natural gas-fired supplemental room heaters shall provide to each purchaser a copy of 527 CMR 30 upon sale of the unit.

In the State of Massachusetts the gas cock must be a T-handle type. The State of Massachusetts requires that a flexible appliance connector cannot exceed three feet in length.

UNPACKING

⚠ CAUTION: Do not remove the metal data plates attached to the burner pan. The data plates contain important product information.

1. Remove logs, hearth kit, pan materials, and hardware from carton.
2. Remove all protective packaging applied to logs and base for shipment.
3. Check all items for any shipping damage. If damaged, promptly inform dealer where you bought the product.

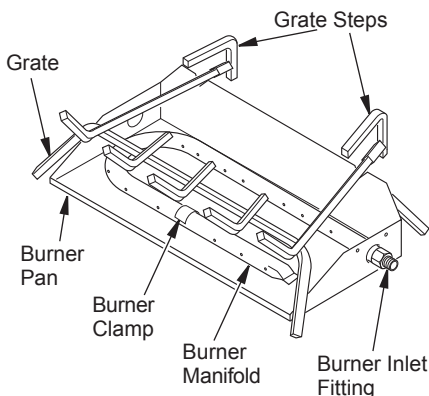

**Figure 1 - Product Identification
(WAN24LA Shown)**

AIR FOR COMBUSTION AND VENTILATION

⚠ WARNING: If the area in which the heater may be operated does not meet the required volume for indoor combustion air, combustion and ventilation air shall be provided by one of the methods described in the *National Fuel Gas Code, ANSI Z223.1/NFPA 54, the International Fuel Gas Code, or applicable local codes.*

Today's homes are built more energy efficient than ever. New materials, increased insulation, and new construction methods help reduce heat loss in homes. Home owners weather strip and caulk around windows and doors to keep the cold air out and the warm air in. During heating months, home owners want their homes as airtight as possible.

While it is good to make your home energy efficient, your home needs to breathe. Fresh air must enter your home. All fuel-burning appliances need fresh air for proper combustion and ventilation.

Exhaust fans, fireplaces, clothes dryers, and fuel burning appliances draw air from the house to operate. You must provide adequate fresh air for these appliances. This will ensure proper venting of vented fuel-burning appliances.

⚠ WARNING: Before installing in a solid fuel burning fireplace, the chimney flue and firebox must be cleaned of soot, creosote, ashes, and loose paint by a qualified chimney cleaner. Creosote will ignite if highly heated. A dirty chimney flue may create and distribute soot within the house. Inspect chimney flue for damage.

NOTICE: Installation, service, and repair of this appliance must be performed by a qualified installer, service agency, company or gas supplier experienced with this type of gas appliance. Only factory authorized components listed in these instructions may be used in accordance with the manufacturer's instructions and all codes and requirements of the authority having jurisdiction. Any modifications to this kit, or use of unauthorized components, or accessory items, will void the manufacturer's warranty, and may result in a hazardous condition.

INSTALLATION

CHECK GAS TYPE

Use only natural gas. If your gas supply is not natural gas, you must install On/Off Safety Pilot Valve Kit (see *Accessories*, page 15).

If the fireplace does not have a gas supply shutoff valve, one must be installed.

VENTING SPECIFICATIONS FOR INSTALLATION

The fireplace chimney flue and vent must be drafting properly. To check the vent for proper drafting, light a tightly rolled newspaper on one end and place it at the inside front edge of the fireplace. Observe the smoke and be sure the vent is properly drawing it up the chimney.

If the smoke spills out into the room, extinguish the flame and remove any obstruction until proper venting is achieved. The chimney flue must remain open a minimum of 3" at all times during the operation of this log set.

INSTALLATION

INSTALLING DAMPER CLAMP

Secure the damper stop clamp provided to the leading edge of the damper as shown in Figure 2. If for any reason this clamp doesn't work on your fireplace, another suitable clamp or permanent stop must be installed, or the damper blade must be cut or removed.

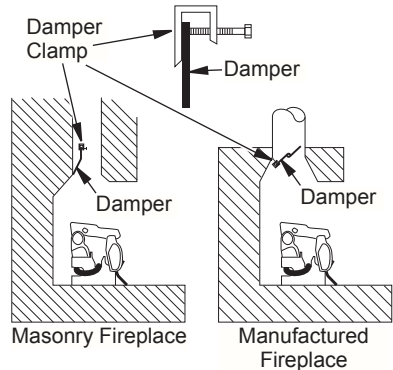

Figure 2 - Attaching Damper Clamp

HEARTH KIT ASSEMBLY

Note: The following instructions apply to dual flame "U" style burners. Be sure all pipe threaded connections are tight, and have thread compound to prevent leaks.

1. Determine which side the gas line will be coming into the fireplace.

Gas line is on the right side. This unit is manufactured with the gas inlet on the right side of the burner pan. See [Connecting to Gas Supply](#), page 8.

Gas line is on the left side. If your gas line will be coming into the fireplace from the left side, continue with step 2.

2. Using a screwdriver, remove cover plate on left side of burner pan (see Figure 3).
3. Unscrew burner inlet fitting from burner manifold (see Figure 3).
4. Place burner manifold in pan with threaded opening facing opening on left side.
5. Using thread sealant (resistant to the action of natural gas) on larger end of fitting, screw the burner inlet fitting through hole and into burner manifold. Tighten using a wrench.
6. Using burner clamp, screw, and nut provided, assemble clamp to pan. This will hold the burner manifold in place.
7. Using screws removed in step 2, install cover plate over opening on right side of burner pan.
8. If using optional control system kit, follow instructions included with kit for installation and operation.

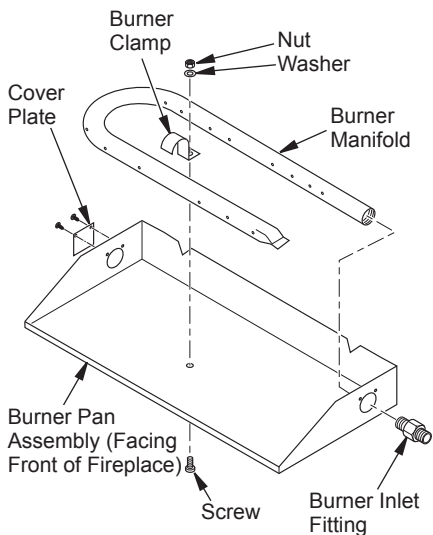

Figure 3 - Installing Burner

INSTALLATION

Installation and Gas Connection

1. Place the burner pan assembly in the center of the fireplace floor. Make sure the front of pan faces forward.
2. Thread the gas supply fitting to the fireplace gas supply pipe. Use thread sealant.
3. Install adapter fitting onto the burner inlet fitting using thread sealant on male threads of burner inlet fitting (see Figure 4).
4. Install the gas connector tube to the gas supply fitting. Carefully shape tube to attach to adapter fitting.

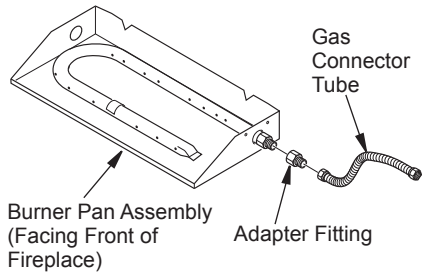

Figure 4 - Connecting Gas to Appliance

CONNECTION TO GAS SUPPLY

⚠ WARNING: A qualified service person must connect log set to gas supply. Follow all local codes.

Installation Items Needed

Before installing log set, make sure you have the items listed below.

- piping (check local codes)
- sealant (resistant to natural gas)
- equipment shutoff valve
- test gauge connection
- adjustable (crescent) wrench or pliers
- sediment trap
- tee joint
- pipe wrench

⚠ CAUTION: Only use a new, black iron or steel pipe. Internally-tinned copper tubing may be used in certain areas. Check your local codes. Use pipe of 1/2" diameter or greater to allow proper gas volume to log set. If pipe is too small, loss of pressure will occur.

Installation must include an equipment shutoff valve, union, and plugged 1/8" NPT tap. Locate NPT tap within reach for test gauge hook up. NPT tap must be upstream from log set (see Figure 5).

IMPORTANT: Install equipment shutoff valve in an accessible location. The equipment shutoff valve is for turning on or shutting off the gas to the appliance.

Apply pipe joint sealant lightly to male threads. This will prevent excess sealant from going into pipe. Excess sealant in pipe could result in a clogged burner injector.

Install sediment trap in supply line as shown in Figure 5. Locate sediment trap where it is within reach for cleaning. Locate sediment trap where trapped matter is not likely to freeze. A sediment trap traps moisture and contaminants. This keeps them from going into log set controls. If sediment trap is not installed or is installed incorrectly, log set may not run properly.

Approved Flexible Gas Hose
(if allowed by local codes)

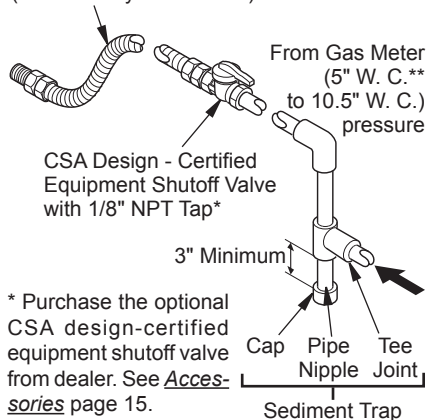

* Purchase the optional CSA design-certified equipment shutoff valve from dealer. See [Accessories](#) page 15.

** Minimum inlet pressure for purpose of input adjustment.

Figure 5 - Gas Connection

INSTALLATION

CHECKING GAS CONNECTIONS

⚠ WARNING: Test all gas piping and connections for leaks after installing or servicing. Correct all leaks immediately.

⚠ WARNING: Never use an open flame to check for a leak. Apply a noncorrosive leak detection fluid to all joints. Bubbles forming show a leak. Correct all leaks immediately.

PRESSURE TESTING GAS SUPPLY PIPING SYSTEM

Test Pressures In Excess Of 1/2 PSIG (3.5kPa)

1. Disconnect heater with its appliance main gas valve (control valve) and equipment shutoff valve from gas supply piping system. Pressures in excess of 1/2 PSIG will damage heater regulator.
2. Cap off open end of gas pipe where equipment shutoff valve was connected.
3. Pressurize supply piping system by either using compressed air or opening gas supply tank valve.
4. Check all joints of gas supply piping system. Apply a noncorrosive leak detection fluid to gas joints. Bubbles forming show a leak.
5. Correct all leaks immediately.
6. Reconnect log set and equipment shutoff valve to gas supply. Check reconnected fittings for leaks.

Test Pressures Equal To or Less Than 1/2 PSIG (3.5 kPa)

1. Close equipment shutoff valve (see Figure 6).
2. Pressure supply piping system by either using compressed air or opening gas supply tank valve.
3. Check all joints from gas meter to equipment shutoff valve (see Figure 7). Apply a noncorrosive leak detection fluid to gas joints. If bubbles form, there may be a leak.
4. Correct all leaks immediately.

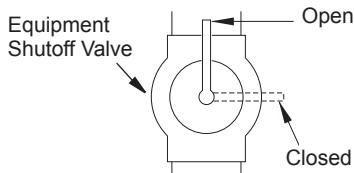

Figure 6 - Equipment Shutoff Valve

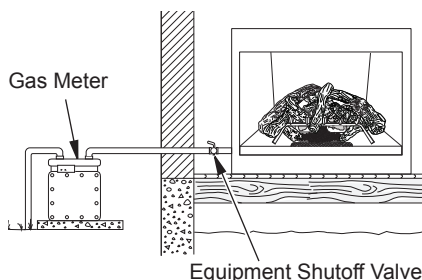

Figure 7 - Checking Gas Joints

INSTALLATION

TESTING BURNER FOR LEAKS

⚠ WARNING: Never check for gas leaks with open flame.

1. Generously apply a noncorrosive leak detection fluid to all connections.
2. Light the burner with the shutoff valve, no more than half open, and holding a match slightly in front of the pan (see *Lighting Instructions*, page 13).
3. Inspect all connections for bubbles, raw gas odor, or flame from any area other than the burner (leaks). If leaks are detected, shut off the gas valve immediately. Tighten, or reassemble the loose connection(s) using pipe joint compound until burner system is leak free.

4. When the burner is tested and leak free, observe the individual tongues of flame on the burner.

Note: Let the burner manifold cool first before removing to unclog port blockages. The burner design includes more ports on the outside of the bar. Make sure that all ports are clear and producing flame evenly across the burner. If any ports appear blocked, clear them by removing the burner manifold and reaming the ports with a modified paper clip or other suitable tool.

5. When finished testing, turn the gas shutoff valve OFF to extinguish all flames.

ADDING PAN MATERIAL

1. Open the bag of ash bed material (vermiculite) and spread it evenly across the burner pan to the top. You may over-flow the front and sides of the pan to cover the entire pan and connecting hardware. Do not cover control system valve.
2. Open the glowing embers and evenly cover the ash bed material (vermiculite) in the burner pan.

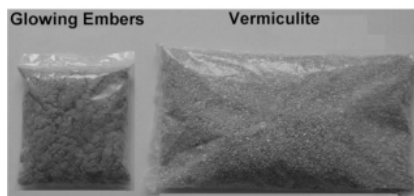

Figure 9 - Glowing Embers and Vermiculite

INSTALLING LOGS

⚠ WARNING: Failure to position the parts in accordance with these diagrams or failure to use only parts specifically approved with this heater may result in property damage or personal injury.

It is very important to install the logs exactly as instructed. Do not modify logs. Use only logs supplied with heater.

Each log is marked with a number. This number will help you to identify the logs when installing.

After installing logs, add decorative cinders around the grate base, do not place any decorative cinders on logs or burner.

Note: Leave as much open space between top logs as possible to minimize flame impingement and sooting.

Note: Logs may chip if they are handled roughly or if hit together while being placed.

INSTALLATION

MODEL WAN18LA

1. Slide the two rear log grate steps over the two outer horizontal supports on the grate as shown in Figure 10.
2. Place back log #1 onto the grate steps as shown in Figure 11).
3. Place front logs #2 and #3 on the grate and slide forward against the front bars on the grate (see Figure 12).
4. Place logs #4 and #5 onto logs #1, #2 and #3 by inserting locating pin on log #1 into lower hole of logs #4 and #5 (see Figure 13).
5. Place log #6 onto log #5 by inserting locating pin on log #5 into lower hole of log #6 (see Figure 14).
6. Place log #7 onto logs #4 and #6 by inserting locating pin on log #4 into lower hole of log #7 (see Figure 14).

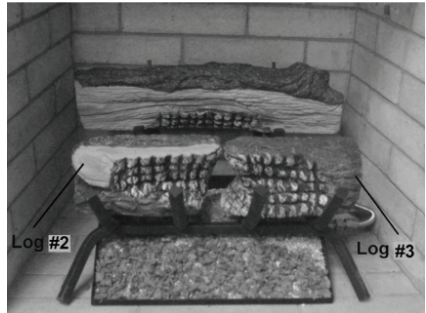

Figure 12 - Installing Front Logs #2 & #3

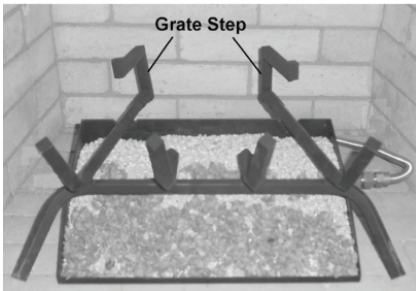

Figure 10 - Installing Grate Steps

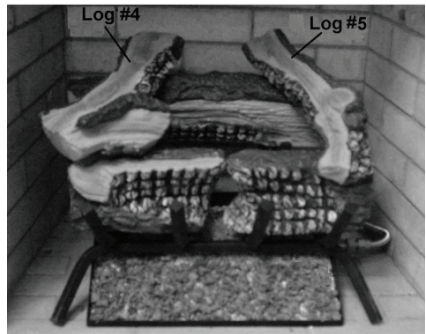

Figure 13 - Installing Top Logs #4 & #5

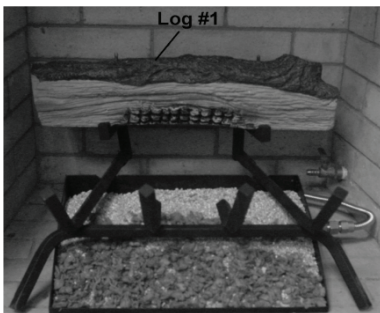

Figure 11 - Installing Back Log #1

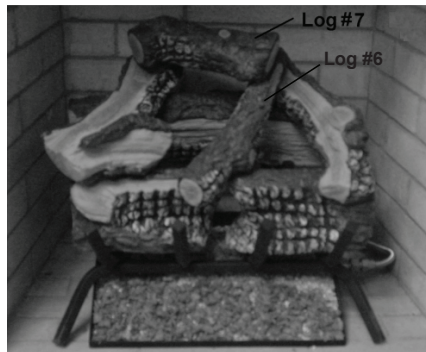

Figure 14 - Installing Top Logs #6 & #7

INSTALLATION

MODEL WAN24LA

1. Slide the two rear log grate steps over the two outer horizontal supports on the grate as shown in Figure 15.
2. Place back log #1 onto the grate steps (see Figure 16).
3. Place front logs #2 and #3 on the grate and slide forward against the front bars on the grate (see Figure 17).
4. Place logs #4 and #5 onto logs #1, #2 and #3 by inserting locating pin on log #1 into lower hole of logs #4 and #5 (see Figure 18).
5. Place log #6 onto log #5 by inserting locating pin on log #5 into lower hole of log #6 (see Figure 19).
6. Place log #7 onto logs #4 and #6 by inserting locating pin on log #4 into lower hole of log #7 (see Figure 19).
7. Place log #8 onto logs #6 and #7 by inserting locating pin on log #7 into lower hole of log #8 (see Figure 20).

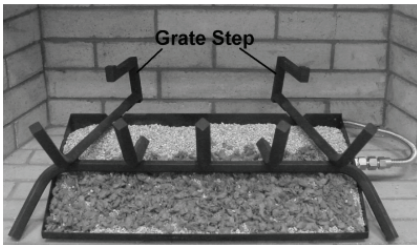

Figure 15 - Installing Grate Steps

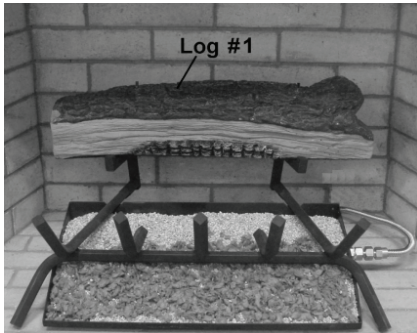

Figure 16 - Installing Back Log #1



Figure 17 - Installing Front Logs #2 & #3

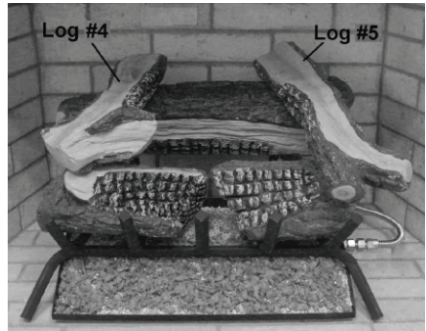

Figure 18 - Installing Top Logs #4 & #5

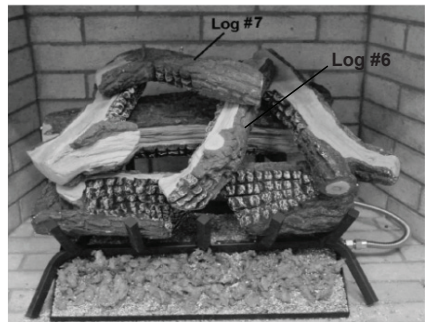

Figure 19 - Installing Top Logs #6 & #7

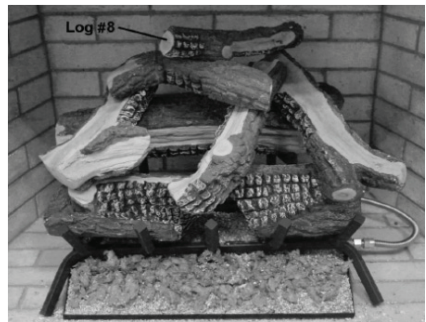

Figure 20 - Installing Top Log #8

OPERATION

FOR YOUR SAFETY READ BEFORE LIGHTING

⚠ WARNING: If you do not follow these instructions exactly, a fire or explosion may result causing property damage, personal injury or loss of life.

- A. This appliance has a pilot which must be lighted by hand. When lighting the pilot, follow these instructions exactly.
- B. BEFORE LIGHTING smell all around the appliance area for gas. Be sure to smell next to the floor because some gas is heavier than air and will settle on the floor.
- WHAT TO DO IF YOU SMELL GAS**
- Do not try to light any appliance.
 - Do not touch any electric switch; do



- not use any phone in your building.
 - Immediately call your gas supplier from a neighbor's phone. Follow the gas supplier's instructions.
 - If you cannot reach your gas supplier, call the fire department.
- C. Use only your hand to push in or turn the gas control knob. Never use tools. If the knob will not push in or turn by hand, don't try to repair it, call a qualified service technician. Force or attempted repair may result in a fire or explosion.
- D. Do not use this appliance if any part has been under water. Immediately call a qualified service technician to inspect the appliance and to replace any part of the control system and any gas control which has been under water.

LIGHTING INSTRUCTIONS

1. STOP! Read the safety information above.
2. Turn the gas shutoff valve to OFF.
3. Wait five (5) minutes to clear out any gas. If you still smell gas, STOP! Follow the safety information above. If you don't smell gas, go on to the next step.
4. Light a match and lay it on top of the pan material about 2" from the end of the supply side of the pan.
5. Slowly turn the gas shutoff valve ON until the burner ignites. If the burner doesn't ignite within 10 seconds with the match burning, turn the shutoff valve OFF and repeat steps 1 through 4 again.

GAS SHUTOFF VALVE OPERATION

Flame Adjustment

Adjust the flame ON/OFF by turning the gas shutoff valve counterclockwise  to open or clockwise  to close, as necessary.

Shutting Off Appliance

Turn gas shutoff valve clockwise  to the OFF position.

CURING LOGS

During the 2-3 hour appliance curing period, you may detect an odor from the appliance as the various paints and compounds used in the manufacturing of this log set cure. This is a normal and temporary situation that is not cause for alarm. However, you may want to provide extra ventilation to the room during this time.

To ensure proper curing of the logs:

- Ignite a 2" flame and maintain it for 1 hour.
- Burn the logs in consecutive 1 hour periods raising the flame an additional 2" to full flame height for a total of three hours.

CARE AND MAINTENANCE

- Keep the area around the log set clean and clear of debris.
- Occasionally, you may use a soft bristle brush to clean logs.
- Once every year a qualified agency or certified chimney sweep should examine and clean the venting system of the fireplace.

ACCESSORIES

Purchase these fireplace accessories from your local dealer. If they can not supply these accessories, contact customer service department for information.

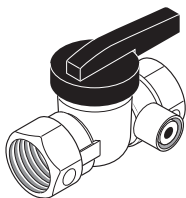

EQUIPMENT SHUTOFF VALVE

For all models. Equipment shutoff valve with 1/8" NPT tap. Fits 1/2" NPT pipe.

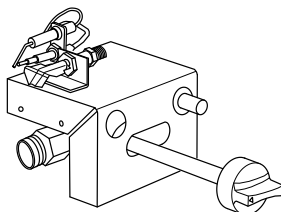

NVDWA1 - ON/OFF SAFETY PILOT VALVE KIT

For all models. Required for propane/LP installation.

TROUBLESHOOTING

- ⚠ WARNING: If you smell gas:**
- Shut off gas supply.
 - Do not try to light any appliance.
 - Do not touch any electrical switch; do not use any phone in your building.
 - Immediately call your gas supplier from a neighbor's phone. Follow the gas supplier's instructions.
 - If you cannot reach your gas supplier, call the fire department.

⚠ WARNING: Only a qualified service technician should service and repair heater. Make sure that power is turned off before proceeding. Turn off and let cool before servicing.

⚠ CAUTION: Never use a wire, needle, or similar object to clean ODS/pilot. This can damage ODS/ pilot unit.

IMPORTANT: Operating heater where impurities in air exist may create odors. Cleaning supplies, paint, paint remover, cigarette smoke, cements and glues, new carpet or textiles, etc., create fumes. These fumes may mix with combustion air and create odors.

Note: All troubleshooting items are listed in order of operation.

Problem	Possible Cause	Corrective Action
Log set is smoking/ soot-ing excessively <i>Note: It is natural and unavoidable for vented gas log sets to produce moderate levels of carbon (soot) where flames contact the logs.</i>	<ol style="list-style-type: none"> 1. Poor fuel quality. 2. Fireplace venting system not drafting properly. 3. Excessive flame impingement or blockage. 4. Improper fuel/air mixture. 5. Excessive gas supply/ pressure. 	<ol style="list-style-type: none"> 1. Contact local natural gas company. 2. Adjust damper wide open and/or have fireplace and venting professionally cleaned and checked. 3. Separate the logs to allow more flame passage. 4. Remove any foreign items from the flame pattern. 5. Preheat flue in very cold weather.
Burner is excessively noisy. <i>Note: The movement and combustion of gas will create low, unavoidable levels of noise.</i>	<ol style="list-style-type: none"> 1. Passage of air/gas across irregular surfaces. 	<ol style="list-style-type: none"> 1. Relieve any tight bends or kinks in gas supply line.
Burner flame is too low or too high.	<ol style="list-style-type: none"> 1. Incorrect gas supply or pressure. 2. Blocked burner orifice or burner manifold ports. 3. Improper burner orifice size. 	<ol style="list-style-type: none"> 1. Check for proper gas supply pressure. 2. Free burner orifice and manifold ports of any burrs, paint, or other blockage. 3. Verify proper burner orifice sizing (see page 3).

TROUBLESHOOTING

Problem	Possible Cause	Corrective Action
Log set produces a clicking/ticking noise just after burner is lit or shut off.	1. Metal expanding while heating or contracting while cooling.	1. This is common with most log sets. If noise is excessive, contact qualified service person.
Log set produces unwanted odors.	1. Log Set burning vapors from paint, hair spray, glues, cleaners, chemicals, new carpet, etc. (See IMPORTANT statement page 16). 2. Gas leak. See Warning statement page 16.	1. Open flue to maximum. Stop using odor causing products while log set is running. 2. Locate and correct all leaks (see <u>Checking Gas Connections</u> , page 9).
Gas odor even when control knob is in OFF position.	1. Gas leak. See Warning statement page 16. 2. Control valve defective	1. Locate and correct all leaks (see <u>Checking Gas Connections</u> , page 9). 2. Replace control valve.
Gas odor during combustion.	1. Gas leak. See Warning statement at top of page 16.	1. Locate and correct all leaks (see <u>Checking Gas Connections</u> , page 9).

REPLACEMENT PARTS

Note: Use only original replacement parts. This will protect your warranty coverage for parts replaced under warranty.

PARTS UNDER WARRANTY

Contact authorized dealers of this product. If they can't supply original replacement parts, call Customer Service toll free at 1-866-573-6074 for referral information.

When calling Customer Service or your dealer, have ready:

- Your name
- Your address

- Model and serial number of your heater
- How heater was malfunctioning
- Type of gas used (Propane/LP or Natural gas/NG)

- Purchase date

Usually, we will ask you to return the defective part to the factory

PARTS NOT UNDER WARRANTY

Contact authorized dealers of this product. If they can't supply original replacement part(s) call Customer Service toll free at 1-866-573-6074 for referral information.

When calling Customer Service have ready:

- Model number of your heater
- The replacement part number

PARTS

MODELS WAN18LA AND WAN24LA

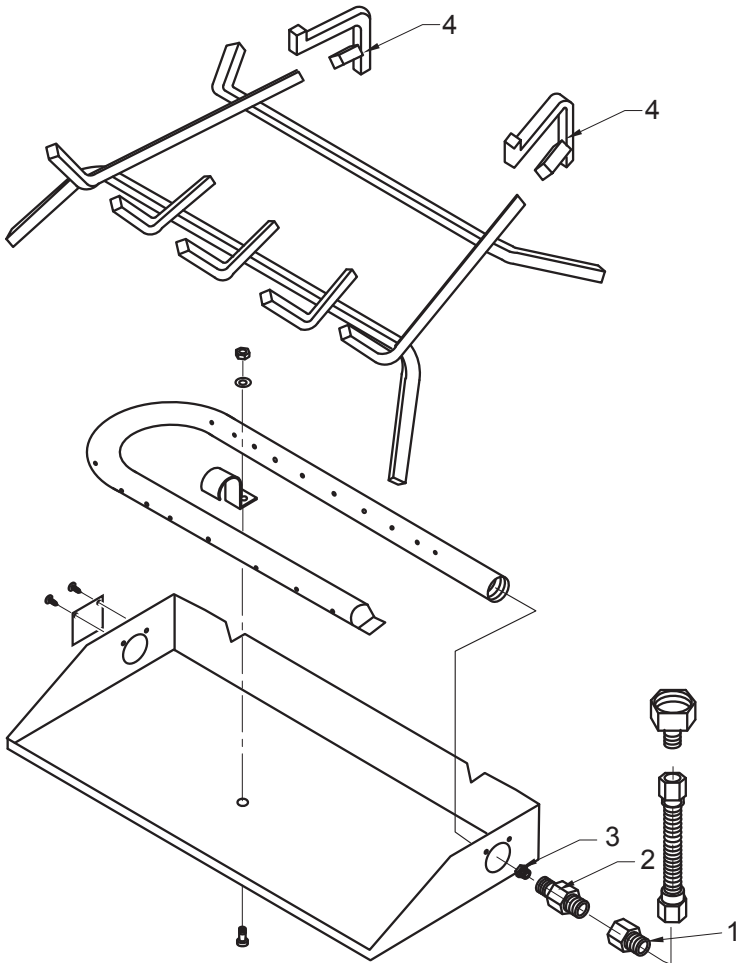

ITEM	WAN18LA	WAN24LA	DESCRIPTION	QTY
1	BL050-01	BL050-01	3/8" Female x 5/8" Flare Adapter	1
2	WAL06-01	WAL06-01	Injector Mounting	1
3	WAL07-01N	WAL07-02N	Injector	1
4	WAB18-01	WAB18-01	Grate Step	2

PARTS AVAILABLE - NOT SHOWN

	WAL11-01	Vermiculite	1
	GLEMVERM25	Glowing Embers	1
	WAN300B	Hardware Package	1
	WAL08-02	1/2" Female x 5/8" Flare Adapter	1
	WAL13-01	Damper Clamp	1

PARTS

MODELS WAN18LA AND WAN24LA

This list contains replaceable parts used in your heater. When ordering parts, follow the instructions listed under Replacement Parts on page 17 of this manual.

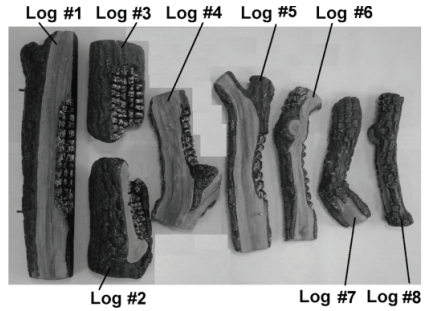
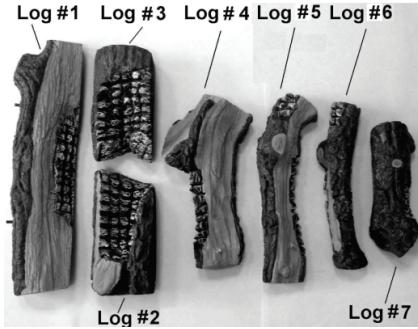

WAN18LA	
WAB04	Log Assembly
WAN18LA-1	Log 1
WAN18LA-2	Log 2
WAN18LA-3	Log 3
WAN18LA-4	Log 4
WAN18LA-5	Log 5
WAN18LA-6	Log 6
WAN18LA-7	Log 7

WAN24LA	
WAB06	Log Assembly
WAN24LA-1	Log 1
WAN24LA-2	Log 2
WAN24LA-3	Log 3
WAN24LA-4	Log 4
WAN24LA-5	Log 5
WAN24LA-6	Log 6
WAN24LA-7	Log 7
WAN24LA-8	Log 8

WARRANTY

KEEP THIS WARRANTY

Model _____
Serial No. _____
Date Purchased _____

Keep receipt for warranty verification.

REGISTER YOUR PRODUCT AT WWW.USAPROCOM.COM

IMPORTANT: We urge you to register your product within 10 days of date of installation, complete with entire serial number which can be found on the rating plate. Please fill out the warranty information above for your personal records. Retain this manual for future reference.

Always specify model and serial numbers when communicating with customer service.

We reserve the right to amend these specifications at any time without notice. The only warranty applicable is our standard written warranty. We make no other warranty, expressed or implied.

LIMITED WARRANTY

ProCom Heating, Inc. warrants this product to be free from defects in materials and components for ONE (1) year from the date of first purchase, provided that the product has been properly installed by a qualified installer in accordance with all local codes and instructions furnished with the unit, operated and maintained in accordance with all applicable instructions. To make a claim under this warranty, the Bill of Sale or cancelled check must be presented.

RESPONSIBILITY OF OWNER

This warranty is extended only to the original retail purchaser. This warranty covers the cost of part(s) required to restore this heater to proper operating condition. Warranty part(s) MUST be obtained through ProCom Heating, Inc. who will provide original factory replacement parts. Failure to use original factory replacement parts voids this warranty. The heater MUST be installed by a qualified installer in accordance with all local codes and instructions furnished with the unit.

WHAT IS NOT COVERED

This warranty does not apply to parts that are not in original condition because of normal wear and tear or parts that fail or become damaged as a result of misuse, accidents, lack of proper maintenance or defects caused by improper installation. Travel, diagnostic cost, labor, transportation and any and all such other costs related to repairing a defective heater will be the responsibility of the owner.

TO THE FULL EXTENT ALLOWED BY THE LAW OF THE JURISDICTION THAT GOVERNS THE SALE OF THE PRODUCT, THIS EXPRESS WARRANTY EXCLUDES ANY AND ALL OTHER EXPRESSED WARRANTIES AND LIMITS THE DURATION OF ANY AND ALL IMPLIED WARRANTIES. INCLUDING WARRANTIES OF MERCHANTABILITY AND FITNESS FOR A PARTICULAR PURPOSE TO TWO (2) YEARS ON ALL COMPONENTS FROM THE DATE OF FIRST PURCHASE. PROCOM HEATING, INC.'S LIABILITY IS HEREBY LIMITED TO THE PURCHASE PRICE OF THE PRODUCT AND PROCOM HEATING, INC. SHALL NOT BE LIABLE FOR ANY OTHER DAMAGES WHATSOEVER INCLUDING INDIRECT, INCIDENTAL OR CONSEQUENTIAL DAMAGES.

Some states do not allow a limitation on how long an implied warranty lasts or an exclusion or limitation of accidental or consequential damages, the above limitation on implied warranties, or exclusion or limitation on damages may not apply to you.

This warranty gives you specific legal right, and you may also have other rights that vary from state to state.



ProCom Heating, Inc.
Bowling Green, KY 42101
www.usaprocom.com
1-866-573-0674

200063-01
Rev. A
05/13