

10,000 BTU/Hr

Thermostatically-Controlled Heater

**BLUE FLAME VENT-FREE  
PROPANE GAS HEATER  
OWNER'S OPERATION AND  
INSTALLATION MANUAL**

**MODELS  
ML100HBAHR  
ML100TBAHR**



**⚠ WARNING:** If the information in this manual is not followed exactly, a fire or explosion may result causing property damage, personal injury or loss of life.

- Do not store or use gasoline or other flammable vapors and liquids in the vicinity of this or any other appliance.
- **WHAT TO DO IF YOU SMELL GAS**
  - Do not try to light any appliance.
  - Do not touch any electrical switch; do not use any phone in your building.
  - Immediately call your gas supplier from a neighbor's phone. Follow the gas supplier's instructions.
  - If you cannot reach your gas supplier, call the fire department.
- Installation and service must be performed by a qualified installer, service agency or the gas supplier.

**INSTALLER:** Leave this manual with the appliance.  
**CONSUMER:** Retain this manual for future reference.



**Questions, problems, missing parts?** Before returning to your retailer, call our customer service department at 1-866-573-0674, 8:00 am - 4:30 pm CST, Monday through Friday or email [contact@usaprocom.com](mailto:contact@usaprocom.com)

---

---

## TABLE OF CONTENTS

---

---

Safety .....	3	Operation.....	16
Product Features.....	5	Inspecting Heater .....	19
Specifications .....	5	Care And Maintenance .....	20
Qualified Installing Agency .....	6	Troubleshooting.....	21
Product Features.....	6	PARTS .....	24
Local Codes.....	6	Replacement Parts.....	26
Unpacking.....	6	Accessories .....	26
Propane Supply.....	7	Service Hints .....	27
Air For Combustion and Ventilation.....	7	Technical Service.....	27
Installation .....	9	Warranty .....	28

### SAVE THIS BOOK

**This is an unvented gas-fired heater. It uses air (oxygen) from the room in which it is installed. Provisions for adequate combustion and ventilation air must be provided. Refer to *Air For Combustion and Ventilation* section on page 7 of this manual.**

**⚠ WARNING: Improper installation, adjustment, alteration, service or maintenance can cause injury or property damage. Refer to this manual for correct installation and operational procedures. For assistance or additional information consult a qualified installer, service agency or the gas supplier.**

**This appliance may be installed in an aftermarket,\* permanently located, manufactured (mobile) home, where not prohibited by local codes.**

**This appliance is only for use with the type of gas indicated on the rating plate. This appliance is not convertible for use with other gases.**

\* Aftermarket: Completion of sale, not for purpose of resale, from the manufacturer.

**This heater can only be used in a recreational or commercial enclosure with a window or roof vent. This heater is not for outdoor use.**

### PATENT INFORMATION

This product may be covered by one or more of the following United States patents:  
9,829,195 9,423,123 9,441,833 9,518,732 9,752,779 9,416,977 8,764,436  
8,568,136 8,516,878 8,297,968 8,281,781 8,235,708 7,967,006  
7,967,007 7,730,765 7,677,236 7,607,426 7,434,447

## SAFETY

**⚠ WARNING:** Do not attempt to access or change the setting of the fuel selection means.

Access to and adjustment of the fuel selection means must only be performed by a qualified service person when connecting this appliance to a specified fuel supply at the time of installation.

Change of the selector setting to other than the fuel type specified at the time of the installation could damage this appliance and render it inoperable.

The installer shall replace the access cover before completing the installation and operating this appliance.

**IMPORTANT:** Read this owner's manual carefully and completely before trying to assemble, operate, or service this heater. Improper use of this heater can cause serious injury or death from burns, fire, explosion, electrical shock and carbon monoxide poisoning.

Only a qualified installer, service agent, or local gas supplier may install and service this product.

**⚠ WARNING:** Keep the appliance area clear and free from combustible materials, gasoline, and other flammable vapors and liquids.

This heater is equipped for propane gas. Field conversion is not permitted.

This appliance is only for use with the type of gas indicated on the rating plate. This appliance is not convertible for use with other gases.

**⚠ DANGER:** Carbon monoxide poisoning may lead to death!

**CARBON MONOXIDE POISONING:** Early signs of carbon monoxide poisoning resemble the flu, with headaches, dizziness or nausea. If you have these signs, the heater may not be working properly. Get fresh air at once! Have heater serviced. Some people are more affected by carbon monoxide than others. These include pregnant women, people with heart or lung disease or anemia, those under the influence of alcohol and those at high altitudes.

**PROPANE GAS:** Propane gas is odorless. An odor-making agent is added to the gas. The odor helps you detect a gas leak. However, the odor added to the gas can fade. Gas may be present even though no odor exists.

**⚠ WARNING: FIRE, EXPLOSION AND ASPHYXIATION HAZARD**

Improper adjustment, alteration, service, maintenance, or installation of this heater or its controls can cause death or serious injury.

Read and follow instructions and precautions in User's Information Manual provided with this heater.

**⚠ WARNING:** Do not use any accessories not approved for use with this heater.

**⚠ WARNING:** Carefully supervise young children when they are in the room with the heater.

**⚠ WARNING:** Make sure grill guard is in place before running heater.

---

---

## SAFETY

---

---

**⚠ WARNING: Due to high temperatures, the appliance should be located out of traffic and away from furniture and draperies.**

**⚠ WARNING: Heater becomes very hot when operating. Keep children and adults away from hot surfaces to avoid burns or clothing ignition. Heater will remain hot for a time after shutoff. Allow surfaces to cool before touching.**

**⚠ WARNING: Do not place clothing or other flammable material on or near the appliance. Never place any objects in the heater.**

1. Do not place propane supply tank(s) inside any structure. Propane supply tank(s) must be placed outdoors.
2. Heaters with a maximum input over 6,000 Btu/Hr shall not be installed in a bathroom. Heaters with a maximum input over 10,000 Btu/Hr shall not be installed in a bedroom.
3. This heater needs fresh air ventilation to run properly. This heater has an Oxygen Depletion Sensing (ODS) safety shutoff system. The ODS shuts down the heater if not enough fresh air is available. See [\*Air for Combustion and Ventilation\*](#), pages 7 and 8. If heater keeps shutting off, see [\*Troubleshooting\*](#), page 21.
4. Keep all air openings in front and bottom of heater clear and free of debris. This will ensure enough air for proper combustion.
5. If heater shuts off, do not relight until you have provided fresh, outside air. If heater keeps shutting off, have it serviced.
6. Do not run heater:
  - Where flammable liquids or vapors are used or stored.
  - Under dusty conditions.
7. Always run heater with control knob at PILOT/IGN, LOW or HIGH locked positions. Never set control knob between locked positions. Poor combustion and higher levels of carbon monoxide may result.
8. Before using furniture polish, wax, carpet cleaner, or similar products, turn heater off. If heated, the vapors from these products may create a white powder residue within burner box or on adjacent walls or furniture.
9. Do not use heater if any part has been under water. Immediately call a qualified service technician to inspect the room heater and to replace any part of the control system and any gas control which has been under water.
10. Turn off heater and let cool before servicing. Only a qualified service person should service and repair heater.
11. Operating heater above elevations of 4,500 feet could cause pilot outage.
12. Install and use heater with care. Follow all local ordinances and codes. In the absence of local ordinances and codes, refer to the *Standard for Storage and Handling of Liquefied Petroleum Gas, ANSI/NFPA 58 Installation Code, CAN/CGAB149.2*. This instructs on the safe storage and handling of propane gases.
13. This heater may be used in an approved structure or temporary construction work enclosure with a remote refillable propane cylinder **ONLY** when the cylinder is located outdoors and the heater is used with the hose (included with this heater). **NEVER** bring a refillable propane cylinder indoors. A fire or explosion can occur causing property damage, serious injury or death.
14. Use only the hose and factory preset regulator provided with the heater, when connecting to portable supply gas tank. Use only replacement pressure regulators and hose assemblies specified in this manual.
15. Inspect the hose before each use of the heater. If it is evident there is excessive abrasion or wear or the hose is cut, it must be replaced prior to the heater being put into operation.
16. Use only propane gas set up for vapor withdrawal.

## PRODUCT FEATURES

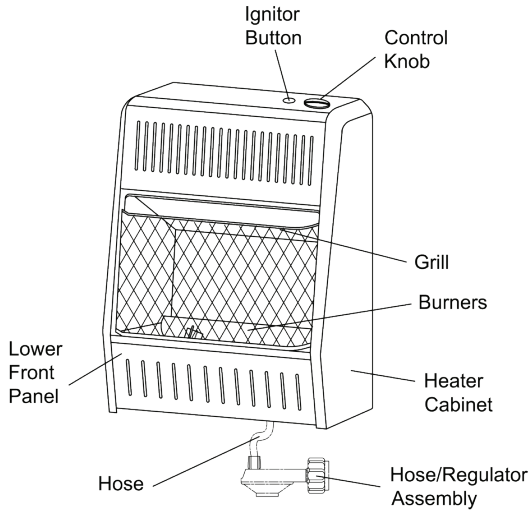

**Figure 1 - Vent-Free Gas Heater**

## SPECIFICATIONS

MODEL	ML100HBAHR	ML100TBAHR
Ignition	Piezo	Piezo
Gas Type	Propane Gas	Propane Gas
BTU (available)	5,500/10,000	10,000
Pressure Regulator Setting	8" W.C.	8" W.C.
Inlet Gas Pressure* (inches of water)	Maximum 14"	Maximum 14"
	Minimum 11"	Minimum 11"
Heater Weight	13 lbs	14 lbs
Shipping Weight	16 lbs	17 lbs
Heater Dimensions (HxWxD) 19 1/8" x 14 1/8" x 6 3/8"		
Carton Dimensions (HxWxD) 22" x 16 3/4" x 8 1/8"		

*Note: Dimensions listed are outer most points on the heater (includes control knobs and grill).*

\* For purposes of input adjustment.

---

---

## QUALIFIED INSTALLING AGENCY

---

---

Only a qualified agency should install and replace gas piping, gas utilization equipment or accessories, and repair and equipment servicing. The term "qualified agency" means any individual, firm, corporation, or company that either in person or through a representative is engaged in and is responsible for:

- a) Installing, testing, or replacing gas piping or
- b) Connecting, installing, testing, repairing, or servicing equipment; that is experienced in such work; that is familiar with all precautions required; and that has complied with all the requirement of the authority having jurisdiction.

---

---

## PRODUCT FEATURES

---

---

### SAFETY PILOT

This heater has a pilot with an Oxygen Depletion Sensing (ODS) safety shutoff system. The ODS/pilot shuts off the heater if there is not enough fresh air.

### PIEZO IGNITION SYSTEM

This heater is equipped with a piezo ignitor. this system requires no matches, batteries, or other sources to light heater.

### THERMOSTATIC CONTROL

#### (Thermostat Models Only)

These heaters have a control valve with a thermostat sensing bulb. This results in the greatest heater comfort and may result in lower gas bills.

---

---

## LOCAL CODES

---

---

Install and use heater with care. Follow all local codes. In the absence of local codes, use the latest edition of *The National Fuel Gas Code, ANSI Z223.1/NFPA 54\**.

\*Available from:

American National Standards Institute, Inc.  
25 West 43rd Street  
New York, NY 10036  
National Fire Protection Association, Inc.  
1 Batterymarch Park  
Quincy, MA 02269-9101

**State of Massachusetts:** The installation must be made by a licensed plumber or gas fitter in the Commonwealth of Massachusetts.

Sellers of unvented propane or natural gas-fired supplemental room heaters shall provide to each purchaser a copy of 527 CMR 30 upon sale of the unit.

In the State of Massachusetts the gas cock must be a T-handle type. The State of Massachusetts requires that a flexible appliance connector cannot exceed three feet in length.

---

---

## UNPACKING

---

---

1. Remove heater from carton.
2. Remove all protective packaging applied to heater for shipping
3. Check heater for any shipping damage. If heater is damaged, promptly inform dealer where you bought heater.

---

---

## PROPANE SUPPLY

---

---

Propane gas and propane tank(s) are to be furnished by the user. The propane cylinder to be used must be constructed and marked in accordance with the specifications for the propane gas cylinders of the U.S. Department of Transportation (DOT).

Use this heater only with a propane vapor withdrawal supply system. See Chapter 5 of the *Standard for Storage and Handling of Liquefied Petroleum Gas, ANSI/NFPA 58 and/or CAN/CGAB 149.2*. Your local library or fire department will have this booklet. The amount of propane gas ready for use from propane

tanks varies. Two factors decide this amount:

1. The amount of propane gas in tank(s)
2. The temperature of tank(s)

This heater is designed for use with a 20 or 40 pound refillable propane cylinder when used as a self contained heating system (with hose and regulator). Larger tanks may be used if installed in a permanent gas supply system. The propane cylinder used must include a collar to protect the cylinder valve and a listed over-filling prevention device (OPD).

---

---

## AIR FOR COMBUSTION AND VENTILATION

---

---

**⚠ WARNING: This heater shall not be installed in a confined space or unusually tight construction unless provisions are provided for adequate combustion and ventilation air. Read the following instructions to insure proper fresh air for this and other fuel-burning appliances in your home.**

Today's homes are built more energy efficient than ever. New materials, increased insulation and new construction methods help reduce heat loss in homes. Home owners weather strip and caulk around windows and doors to keep the cold air out and the warm air in. During heating months, home owners want their homes as airtight as possible.

While it is good to make your home energy efficient, your home needs to breathe. Fresh air must enter your home. All fuel-burning appliances need fresh air for proper combustion and ventilation.

Exhaust fans, fireplaces, clothes dryers and fuel burning appliances draw air from the house to operate. You must provide adequate fresh air for these appliances. This will insure proper venting of vented fuel-burning appliances.

**⚠ WARNING: This heater shall not be installed in a room or space unless the required volume of indoor combustion air is provided by the method described in the *National Fuel Gas Code, ANSI Z223.1/NFPA 54, the International Fuel Gas Code, or applicable local codes.***

**⚠ WARNING: If the area in which the heater may be operated does not meet the required volume for indoor combustion air, combustion and ventilation air shall be provided by one of the methods described in the *National Fuel Gas Code, ANSI Z223.1/NFPA 54, the International Fuel Gas Code, or applicable local codes.***

# AIR FOR COMBUSTION AND VENTILATION

## VENTILATION AIR

### Ventilation Air From Inside Building

This fresh air would come from an adjoining unconfined space. When ventilating to an adjoining unconfined space, you must provide two permanent openings: one within 12" of the ceiling and one within 12" of the floor on the wall connecting the two spaces (see options 1 and 2, Figure 2). You can also remove door into adjoining room (see option 3, Figure 2). Follow the *National Fuel Gas Code, ANSI Z223.1/NFPA 54, Air for Combustion and Ventilation* for required size of ventilation grills or ducts.

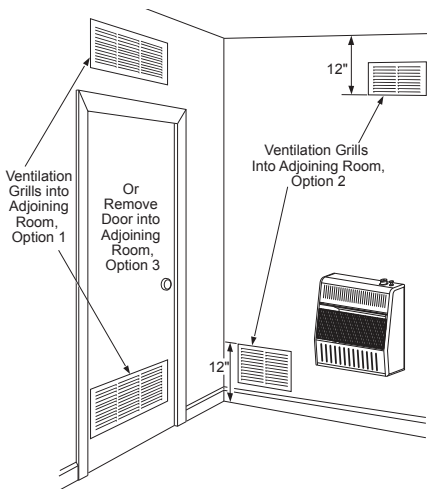
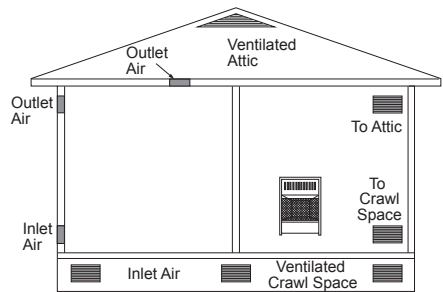

**Figure 2 - Ventilation Air from Inside Building**

### Ventilation Air From Outdoors

Provide extra fresh air by using ventilation grills or ducts. You must provide two permanent openings: one within 12" of the ceiling and one within 12" of the floor. Connect these items directly to the outdoors or spaces open to the outdoors. These spaces include attics and crawl spaces. Follow the *National Fuel Gas Code, ANSI Z223.1/NFPA 54, Air for Combustion and Ventilation* for required size of ventilation grills or ducts.

**IMPORTANT:** Do not provide openings for inlet or outlet air into attic if attic has a thermostat-controlled power vent. Heated air entering the attic will activate the power vent. Rework worksheet, adding the space of the adjoining unconfined space. The combined spaces must have enough fresh air to supply all appliances in both spaces.



**Figure 3 - Ventilation Air from Outdoors**



## INSTALLATION

**NOTICE:** This heater is intended for use as supplemental heat. Use this heater along with your primary heating system. Do not install this heater as your primary heat source. If you have a central heating system, you may run system's circulating blower while using heater. This will help circulate the heat throughout the house. In the event of a power outage, you can use this heater as your primary heat source.

**CAUTION:** When installing heater in a home garage

- heater pilot and burner must be at least 18" above floor
- locate heater where moving vehicle will not hit it

**WARNING:** A qualified service person must install heater. Follow all local codes.

**WARNING:** Never install the heater

- in a bathroom
- in a recreational vehicle
- where curtains, furniture, clothing, or other flammable objects are less than 36" from the front, top, or sides of the heater
- in high traffic areas
- in windy or drafty areas

**WARNING:** When installed in a bathroom, do not use flammable products such as aerosol hair spray or any product that contains flammable vapors. Keep towels and other flammable materials away from heater.

**CAUTION:** This heater creates warm air currents. These currents move heat to wall surfaces next to heater. Installing heater next to vinyl or cloth wall coverings or operating heater where impurities (such as tobacco smoke, aromatic candles, cleaning fluids, oil or kerosene lamps, etc.) in the air exist, may cause walls to discolor.

### CHECK GAS TYPE

Be sure your gas supply is right for your heater. Otherwise, call dealer where you bought the heater for proper type heater.

### CLEARANCES TO COMBUSTIBLES

**WARNING:** Maintain the minimum clearances shown in Figure 4. If you can, provide greater clearances from floor, ceiling, and joining wall.

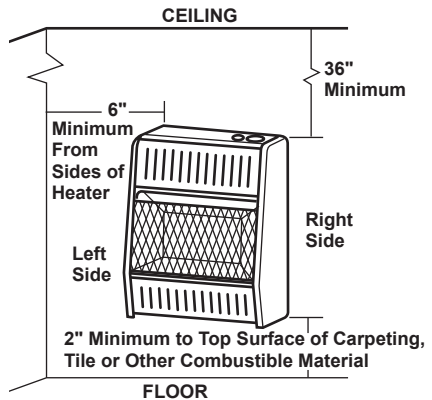

*Figure 4 - Mounting Clearances as Viewed From Front of Heater*

---

---

## INSTALLATION

---

---

### LOCATING HEATER

This heater is designed to be mounted on a wall.

For convenience and efficiency, install heater:

1. Where there is easy access for operation, inspection, and service.
2. In the coldest part of room.

### INSTALLING THERMOSTAT SENSING BULB

#### For Thermostat Model Only

1. Pull out the sensing bulb from the two clips located in the shipping position according to the direction as shown by the arrow. There is no need to take out the two bulb clips.
2. Take out the bulb clip from the hardware package and insert it into the square hole and then insert the sensing bulb into the bulb clip (see Figure 5).

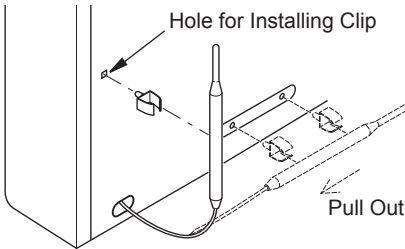

Figure 5 - Moving Thermostat Sensing Bulb

### FASTENING HEATER TO WALL

#### Mounting Bracket

The mounting bracket is located on back panel of heater (see Figure 6). It has been taped there for shipping. Remove mounting bracket from back panel.

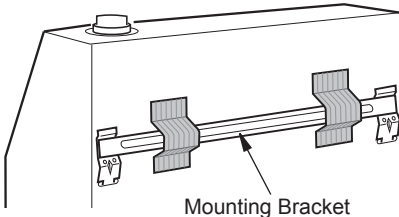

Figure 6 - Mounting Bracket Location

### Removing Front Panel of Heater

1. Remove two screws near bottom corners of lower front panel.
2. Pull bottom of lower front panel forward, then down (see Figure 7).

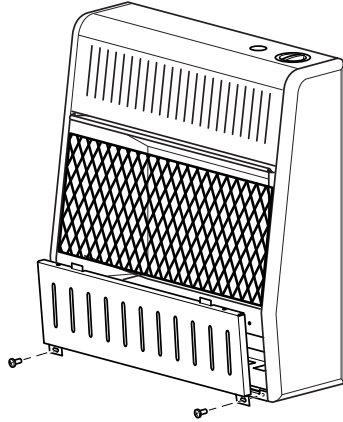

Figure 7 - Removing Front Panel Of Heater

### Methods For Attaching Mounting Bracket To Wall

Use only the last hole on each end of mounting bracket to attach bracket to wall. Attach mounting bracket to a wall only in one of two ways:

1. **Attaching to wall stud:** This method provides the strongest hold. Insert mounting screws through mounting bracket and into wall studs.
2. **Attaching to wall anchor:** This method allows you to attach mounting bracket to hollow walls (wall areas between studs) or to solid walls (concrete or masonry).

Decide which method better suits your needs. Either method will provide a secure hold for the mounting bracket.

# INSTALLATION

## Marking Screw Locations

1. Tape mounting bracket to wall where heater will be located. Make sure mounting bracket is level.

**⚠ WARNING: Maintain minimum clearances shown in Figure 4, page 9. If you can, provide greater clearances from floor and joining wall.**

2. Mark screw locations on wall (see Figure 8). *Note: Mark only last hole on each end of mounting bracket. Insert mounting screws through these holes only.*
3. Remove tape and mounting bracket from wall.

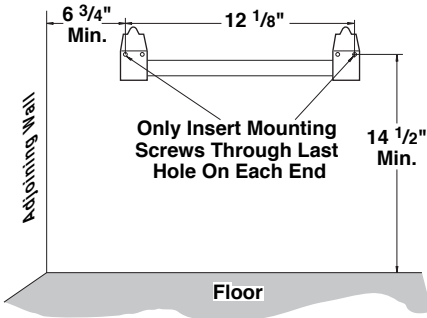

**Figure 8 - Mounting Bracket Clearances**

## Attaching Mounting Bracket To Wall

*Note: Wall anchors, mounting screws, and spacers are in hardware package. The hardware package is provided with heater.*

### Attaching to Wall Stud Method

For attaching mounting bracket to wall studs:

1. Drill holes at marked locations using 9/64" drill bit.
2. Place mounting bracket onto wall. Line up last hole on each end of bracket with holes drilled in wall.
3. Insert mounting screws through bracket and into wall studs.
4. Tighten screws until mounting bracket is firmly fastened to wall studs.

### Attaching to Wall Anchor Method

For attaching mounting bracket to hollow walls (wall areas between studs) or solid walls (concrete or masonry):

1. Drill holes at marked locations using 5/16" drill bit. For solid walls (concrete or masonry), drill at least 1" deep.
2. Fold wall anchor as shown in Figure 9.
3. Insert wall anchor (wings first) into hole. Tap anchor flush to wall.
4. For thin walls (1/2" or less), insert red key into wall anchor. Push red key to "pop" open anchor wings (see Figure 10).

**IMPORTANT:** Do not hammer anchor key! For thick walls (over 1/2" thick) or solid walls, do not pop open wings.

5. Place mounting bracket onto wall. Line up last hole on each end of bracket with wall anchors.
6. Insert mounting screws through bracket and into wall anchors.
7. Tighten screws until mounting bracket is firmly fastened to wall.

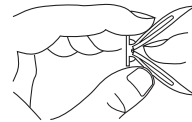

**Figure 9 - Folding Anchor**

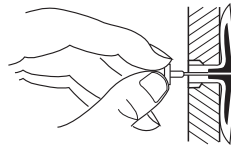

**Figure 10 - Popping Open Anchor Wings For Thin Walls**

## Placing Heater On Mounting Bracket

1. Locate two horizontal slots on back panel of heater (see Figure 11).
2. Place heater onto mounting bracket. Slide horizontal slots onto stand-out tabs on mounting bracket.

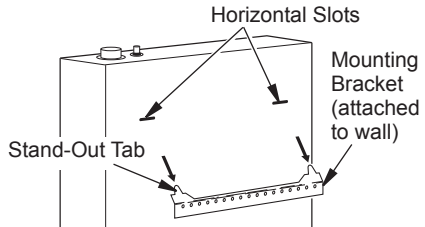

**Figure 11 - Mounting Heater Onto Mounting Bracket**

## INSTALLATION

### Installing Bottom Mounting Bracket

1. Install bottom bracket to heater bottom with two screws. It may be more convenient to remove heater from wall bracket to attach.
2. Place heater on wall mounting bracket.
3. Mark screw locations on wall.
4. Remove heater from mounting bracket.
5. If installing bottom mounting screws into hollow or solid wall, install wall anchors. Follow steps 1 through 4 under *Attaching To Wall Anchor Method*, page 11. If installing bottom mounting screw into wall stud, drill holes at marked locations using 9/64" drill bit.
6. Replace heater onto mounting bracket.
7. Place spacers between bottom mounting holes and wall anchor or drilled hole.
8. Hold spacer in place with one hand. With other hand, insert mounting screw through bottom mounting hole and spacer. Place tip of screw in opening of wall anchor or drilled hole.

9. Tighten both screws until heater is firmly secured to wall. Do not over tighten.

*Note: Do not replace front panel at this time. Replace front panel after making gas connections and checking for leaks.*

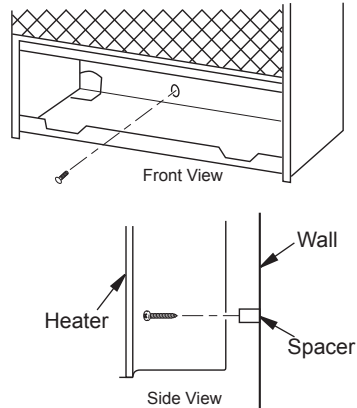

**Figure 12 - Installing Bottom Mounting Screws**

## CONNECTING TO PORTABLE CYLINDER GAS SUPPLY

**⚠ WARNING:** Review and understand the warnings in the *Safety* section, page 3. They are needed to safely operate this heater. Follow all local codes when using this heater.

**⚠ WARNING:** Test all gas piping and connections for leaks after installation or servicing. Never use an open flame to check for a leak. Apply a noncorrosive leak detection fluid to all joints. Bubbles forming show a leak. Correct all leaks at once.

**⚠ WARNING:** Use pipe joint sealant that is resistant to propane gas.

Never bring a refillable propane cylinder indoors. A fire or explosion can occur causing property damage, serious injury or death.

**⚠ WARNING:** This appliance requires a 3/8" NPT (National Pipe Thread) inlet connection to the pressure regulator.

**⚠ WARNING:** A qualified service technician must connect heater to gas supply. Follow all local codes.

*IMPORTANT:* You must use a propane gas supply cylinder that is compatible with the connection device provided with the hose and regulator.

## INSTALLATION

1. Remove gas fitting from hardware bag.
2. Apply pipe joint sealant lightly to male NPT threads (see Figure 13). This will prevent excess sealant from going into pipe. Excess sealant in pipe could result in clogged heater valves.
3. Hold gas pressure regulator with wrench when connecting the gas fitting. Do not over tighten connection to regulator. The regulator body could be damaged.
4. Provide propane supply system (see [Propane Supply](#), page 7).
5. Connect fuel gas fitting on hose/regulator assembly to propane tank(s). Turn fuel gas fitting counterclockwise into threads on tank. Tighten firmly using a wrench. **IMPORTANT:** Position regulator so that hose leaving the regulator is in a horizontal position (see Figure 14). This places the regulator vent in the proper position to protect it from the weather.
6. Connect hose to heater inlet. Tighten firmly using a wrench. You must use the regulator supplied with heater.
7. Open propane supply valve on propane tank(s) slowly.

*Note: If not opened slowly, excess-flow check valve on propane tank may stop gas flow. If this happens, close propane supply valve and open again slowly.*

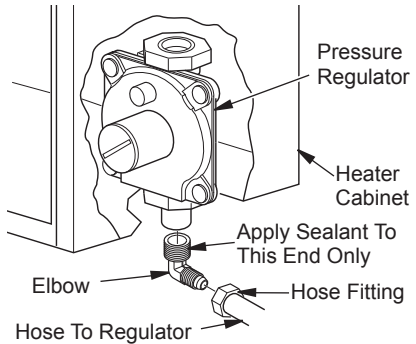

**Figure 13 - Gas Connection**

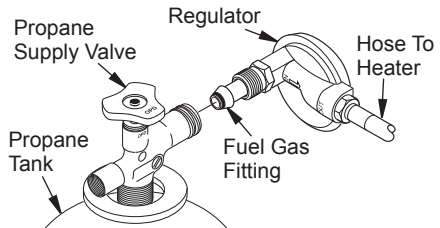

**Figure 14 - Regulator Position**

### CONNECTING TO PERMANENTLY LOCATED GAS SUPPLY (100 pound or Larger Tank)

**⚠ WARNING:** A qualified service technician must connect heater to gas supply. Follow all local codes.

**⚠ WARNING:** This appliance requires a 3/8" NPT (National Pipe Thread) inlet connection to the pressure regulator.

**⚠ WARNING:** Do not over-tighten gas connections.

**⚠ CAUTION:** Use only new, black iron or steel pipe. Internally tinned copper tubing may be used in certain areas. Check your local codes. Use pipe of 1/2" diameter or greater to allow proper gas volume to heater. If pipe is too small, undue loss of pressure will occur.

## INSTALLATION

**⚠ CAUTION: Never connect heater directly to the gas supply. This heater requires an external regulator (not supplied). Install the external regulator between the heater and gas supply. Gas supplier provides external regulator for natural gas. The installer provides the external regulator for propane gas.**

**⚠ CAUTION: Avoid damage to regulator. Hold gas regulator with wrench when connecting into gas piping and/or fittings.**

**⚠ CAUTION: Use pipe joint sealant that is resistant to gas.**

- sealant (resistant to natural gas and propane gas)
- equipment shutoff valve\*
- test gauge connection\*
- sediment trap
- tee joint
- pipe wrench
- flexible gas hose (check local codes)

\* A CSA design-certified equipment shutoff valve with 1/8" NPT tap is an acceptable alternative to test gauge connection. Purchase the optional CSA design certified equipment shutoff valve from your dealer.

### Typical Inlet Pipe Diameters

Heaters up to 20,000 BTU/hr use 3/8" black iron pipe or greater. Installation must include an equipment shutoff valve, union, and plugged 1/8" NPT tap. Locate NPT tap within reach for test gauge hook up. NPT tap must be upstream from heater (see Figure 15).

**IMPORTANT:** Install an equipment shutoff valve in an accessible location. The equipment shutoff valve is for turning on or shutting off the gas to the appliance.

Apply pipe joint sealant lightly to male threads. This will prevent excess sealant from going into pipe. Excess sealant in pipe could result in clogged heater valves.

The installer must supply an external regulator. The external regulator will reduce incoming gas pressure. You must reduce incoming gas pressure to between 11" and 14" of water. If you do not reduce incoming gas pressure, heater regulator damage could occur. Install external regulator with the vent pointing down as shown in Figure 16. Pointing the vent down protects it from freezing rain or sleet.

Before installing heater, make sure you have the items listed below:

- external regulator for propane unit only (supplied by installer)
- piping (check local codes)

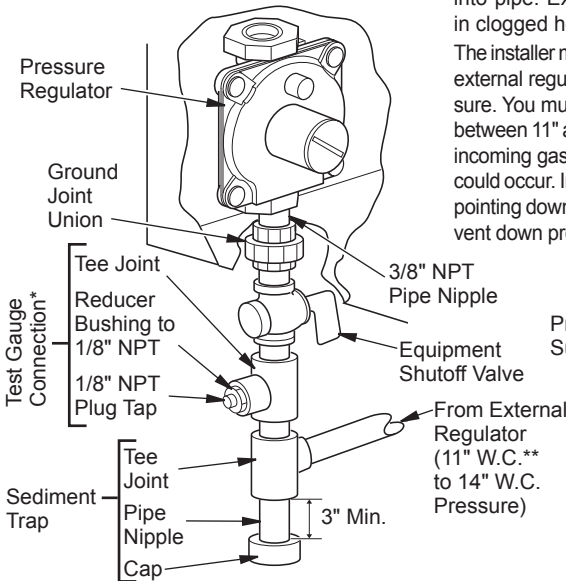

**Figure 15 - Gas Connection**

\* Purchase the optional CSA design-certified equipment shutoff valve from your dealer.

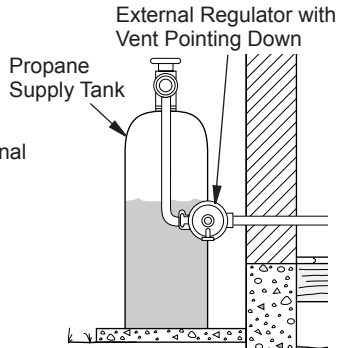

**Figure 16 - External Regulator with Vent Pointing Down**

## INSTALLATION

Install sediment trap in supply line as shown in Figure 15, page 14. Place sediment trap where it is within reach for cleaning. Place sediment trap where trapped matter is not likely to freeze.

A sediment trap traps moisture and contaminants. This keeps them from going into heater controls. If sediment trap is not installed or is installed wrong, heater may not run properly.

### CHECKING GAS CONNECTIONS

**⚠ WARNING: Test all gas piping and connections for leaks after installing or servicing. Correct all leaks at once.**

**⚠ WARNING: Never use an open flame to check for a leak. Apply a noncorrosive leak detection fluid to all joints. If bubbles form, there is a leak. Correct all leaks at once.**

#### PRESSURE TESTING GAS SUPPLY PIPING SYSTEM

##### Test Pressures In Excess Of 1/2 PSIG (3.5 kPa)

1. Disconnect heater with its appliance main gas valve (control valve) and equipment shutoff valve from gas supply piping system. Pressures in excess of 1/2 PSIG will damage heater regulator.
2. Cap off open end of gas pipe where equipment shutoff valve was connected.
3. Pressurize supply piping system by either opening propane supply tank valve for propane gas or opening main gas valve located on or near gas meter for natural gas or using compressed air.
4. Check all joints of gas supply piping system. Apply a noncorrosive leak detection fluid to all joints. If bubbles form, there may be a leak.
5. Correct all leaks at once.
6. Reconnect heater and equipment shutoff valve to gas supply. Check reconnected fittings for leaks.

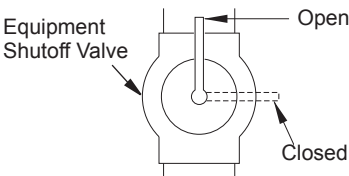

Figure 17 - Equipment Shutoff Valve

#### Test Pressures Equal To or Less Than 1/2 PSIG (3.5 kPa)

1. Close equipment shutoff valve (see Figure 17).
2. Pressurize supply piping system by either opening main gas valve located on or near gas meter or using compressed air.
3. Check all joints from gas supply to equipment shutoff valve (see Figure 18). Apply a noncorrosive leak detection fluid to all joints. If bubbles form, there is a leak.
4. Correct all leaks at once.

#### PRESSURE TESTING HEATER GAS CONNECTIONS

1. Open equipment shutoff valve (see Figure 17).
2. Open gas supply tank valve.
3. Make sure control knob of heater is in the OFF position.
4. Check all joints from equipment shutoff valve to control valve (see Figure 18). Apply a noncorrosive leak detection fluid to all joints. Bubbles forming show a leak.
5. Correct all leaks at once.
6. Light heater (see *Operation*, page 16). Check all other internal joints for leaks.
7. Turn off heater (see *To Turn Off Gas Appliance*, page 18).
8. Replace lower front panel.

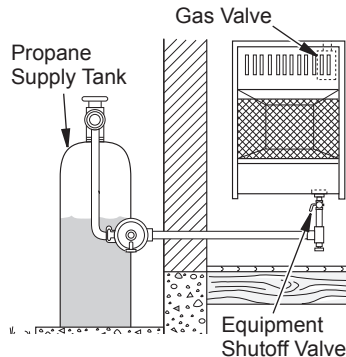

Figure 18 - Checking Gas Joints



## OPERATION

### FOR YOUR SAFETY READ BEFORE LIGHTING

**⚠ WARNING:** If you do not follow these instructions exactly, a fire or explosion may result causing property damage, personal injury or loss of life.

- A. This appliance has a pilot which must be lighted by hand. When lighting the pilot, follow these instructions exactly.
- B. **BEFORE LIGHTING** smell all around the appliance area for gas. Be sure to smell next to the floor because some gas is heavier than air and will settle on the floor.  
**WHAT TO DO IF YOU SMELL GAS**
  - Do not try to light any appliance.
  - Do not touch any electric switch; do

- not use any phone in your building.
  - Immediately call your gas supplier from a neighbor's phone. Follow the gas supplier's instructions.
  - If you cannot reach your gas supplier, call the fire department.
- C. Use only your hand to push in or turn the gas control knob. Never use tools. If the knob will not push in or turn by hand, don't try to repair it, call a qualified service technician. Force or attempted repair may result in a fire or explosion.
  - D. Do not use this appliance if any part has been under water. Immediately call a qualified service technician to inspect the appliance and to replace any part of the control system and any gas control which has been under water.

### MANUAL CONTROL MODEL ML100HBAHR LIGHTING INSTRUCTIONS

1. STOP! Read the safety information above.
2. Check that gas supply to heater is on.
3. Push in gas control knob slightly and turn clockwise ↻ to the OFF position.

*Note: Knob cannot be turned from PILOT to OFF unless knob is pushed in slightly. Do not force.*

4. Wait five (5) minutes to clear out any gas. Then smell for gas, including near the floor. If you smell gas, STOP! Follow "B" in the safety information above. If you do not smell gas, go to the next step.
5. Push in gas control knob slightly and turn counterclockwise ↶ to PILOT/IGN and press for five (5) seconds

*Note: The first time that the heater is operated after connecting the gas supply, the control knob should be pressed for about thirty (30) seconds. This will allow air to bleed from the gas system.*

6. With control knob pressed in, push down and release the ignitor button. This will light pilot. If needed, keep pressing ignitor button until pilot lights.
7. Keep control knob pressed in for 30 seconds after lighting pilot. After 30 seconds, release control knob. If control knob does not pop up when released,

contact a qualified service technician or gas supplier for repairs.

*Note: If pilot goes out, repeat steps 3 through 7. This heater has a safety interlock system. Wait one (1) minute before lighting pilot again.*

8. To select the desired heating level, partially press down the control knob slightly and turn counterclockwise ↶. Release downward pressure on the knob while continuing to turn until the knob locks at the desired setting. The main burner should light. Set control knob to the desired heating position.

*Note: Both HIGH and LOW are locked positions. You must press in the control knob before turning it from these positions.*

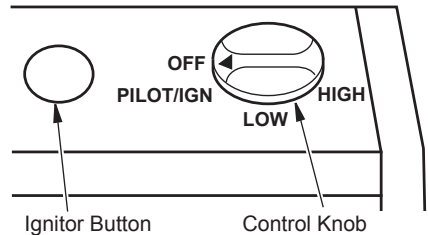

**Figure 19 - Control Knob in the OFF Position**



## OPERATION

**CAUTION:** Do not try to adjust heating levels by using the equipment shutoff valve.

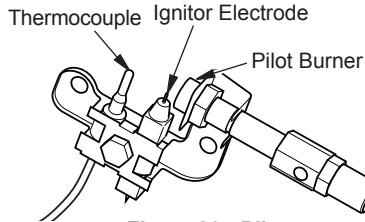



Figure 20 - Pilot

## THERMOSTAT MODEL ML100TBAHR

### LIGHTING INSTRUCTIONS

1. STOP! Read the safety information on page 16.
2. Make sure equipment shutoff valve is fully open.
3. Turn control knob clockwise  to the OFF position.
4. Wait five (5) minutes to clear out any air. Then smell for gas, including near the floor. If you smell gas, STOP! Follow "B" in the safety information, page 16. If you do not smell gas, go to the next step.
5. Turn control knob counterclockwise  to the PILOT position. Press in control knob for five (5) seconds.

*Note: The first time that the heater is operated after connecting the gas supply, the control knob should be pressed for about thirty (30) seconds. This will allow air to bleed from the gas system. If pilot does not stay lit, refer to Troubleshooting, pages 21 through 23. Also contact a qualified service technician or gas supplier for repairs. Until repairs are made, light pilot with match.*

- If control knob does not pop up when released, contact a qualified service technician or gas supplier for repairs.

6. With control knob pressed in, push down and release ignitor button. This will light pilot. The pilot is attached to the front of burner. The pilot can be seen through the grill. If needed, keep pressing ignitor button until pilot lights. *Note: If pilot does not stay lit, refer to Troubleshooting, pages 21 through 23.*

*Also contact a qualified service technician or gas supplier for repairs. Until repairs are made, light pilot with match. To light pilot with match, see Manual Lighting Procedure, page 18.*

7. Keep control knob pressed in for 30 seconds after lighting pilot. After 30 seconds, release control knob. If control knob does not pop up when released, contact a qualified service technician or gas supplier for repairs.

*Note: If pilot goes out, repeat steps 3 through 7. This heater has a safety interlock system. Wait one (1) minute before lighting pilot again.*

8. Turn control knob counterclockwise  to desired heating level. The main burner should light. Set control knob to any heat level between HI and LO.

**CAUTION:** Do not try to adjust heating levels by using the equipment shutoff valve.

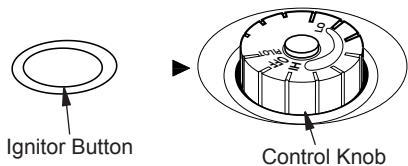

Figure 21 - Control Knob in the OFF Position

---

---

## OPERATION

---

---

### THERMOSTAT CONTROL OPERATION

The thermostatic control used on these models differ from standard thermostats. Standard thermostats simply turn the burner on and off. The thermostat used on this heater senses the room temperature. At times the room may exceed the set temperature. If so, the burner will shut off. The burner will cycle back on when room temperature drops below the set temperature. The control knob can be set to any comfort level between HI and LO.

*Note: The thermostat sensing bulb measures the temperature of air near the heater cabinet. This may not always agree with room temperature (depending on housing construction, installation location, room size, open air temperatures, etc.) Frequent use of your heater will let you determine your own comfort levels.*

### ALL MODELS

#### TO TURN OFF GAS TO APPLIANCE

##### Shutting Off Heater

Turn control knob clockwise  to the OFF position.

##### Shutting Off Burner Only (pilot stays lit)

Turn control knob clockwise  to the PILOT position.

#### MANUAL LIGHTING PROCEDURE

1. Remove lower front panel.
2. Follow steps 1 through 5 under Lighting Instructions, page 16 or 17.
3. With control knob pressed in, strike match. Hold match to pilot until pilot lights.
4. Keep control knob pressed in for 30 seconds after lighting pilot. After 30 seconds, release control knob. Follow step 8 under Lighting Instructions, page 16 or 17.
5. Replace lower front panel.

## INSPECTING HEATER

**IMPORTANT:** Owner's should check pilot flame pattern and burner flame pattern often. Incorrect flame patterns indicate the need for cleaning (see Care and Maintenance, page 20) or service.

**⚠ WARNING:** Only a qualified service person should service and repair heater. This includes maintenance requiring replacement or alteration of components.

### PILOT FLAME PATTERN

Figure 22 shows a correct pilot flame pattern. Figure 23 shows an incorrect pilot flame pattern. The incorrect pilot flame is not touching the thermocouple. This will cause the thermocouple to cool, which shuts the heater off. If pilot flame pattern is incorrect, as shown in Figure 23

- turn heater off (see To Turn Off Gas to Appliance, page 18)
- see Troubleshooting pages 21 through 23.

**⚠ WARNING:** If yellow tipping occurs, your heater could produce increased levels of carbon monoxide. If the burner flame pattern shows yellow tipping, follow instructions below.

**Notice:** Do not mistake orange flames with yellow tipping. Dirt or other fine particles enter the heater and burn causing brief patches of orange flame.

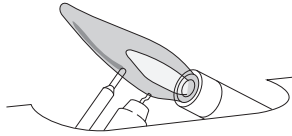

Figure 22 - Correct Pilot Flame Pattern

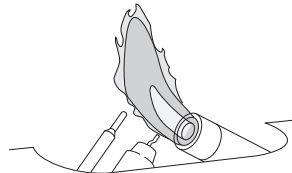

Figure 23 - Incorrect Pilot Flame Pattern

### BURNER FLAME PATTERN

Figure 24 shows a correct burner flame pattern. Figure 25 shows an incorrect burner flame pattern. The incorrect burner flame pattern shows yellow tipping of the flame. It also shows the flame higher than 1/2 the heat shield height.

If burner flame pattern is incorrect, as shown in Figure 25

- turn heater off (see To Turn Off Gas to Appliance, page 18)
- see Troubleshooting pages 21 through 23.

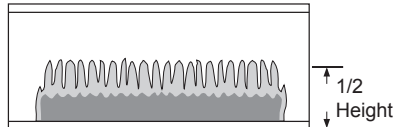

Figure 24 - Correct Burner Flame Pattern

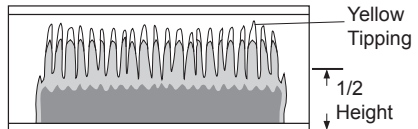

Figure 25 - Incorrect Burner Flame Pattern

## CARE AND MAINTENANCE

**⚠ WARNING:** Turn off heater and let cool before servicing.

**⚠ CAUTION:** You must keep control areas, burner, and circulating air passageways of heater clean. Inspect these areas of heater before each use. Have heater inspected yearly by a qualified service technician. Heater may need more frequent cleaning due to excessive lint from carpeting, bedding material, pet hair, etc.

**⚠ WARNING:** Failure to keep the primary air opening(s) of the burner(s) clean may result in sooting and property damage.

### ODS/PILOT AND BURNER

**⚠ CAUTION:** Never use a wire, needle, or similar object to clean ODS/pilot. This can damage ODS/pilot unit.

Use a vacuum cleaner, pressurized air, or a small, soft bristled brush to clean.

### BURNER PILOT AIR INLET

The primary air inlet hole allows the proper amount of air to mix with the gas. This provides a clean burning flame. Keep this hole clear of dust, dirt and lint. Clean this air inlet hole prior to each heating season. A blocked air hole will create soot. We recommend that you clean the unit every three months during operation and have heater inspected yearly by a qualified service person.

We also recommend that you keep the burner tube and pilot assembly clean and free of dust and dirt. To clean these parts we recommend using compressed air no greater than 30 PSI. Your local computer store, hardware store, or home center may carry compressed air in a can. You can use a vacuum cleaner in the blow position. If using compressed air in a can, please follow the directions on the can. If you don't follow directions on the can, you could damage the pilot assembly.

1. Shut off the unit, including the pilot. Allow the unit to cool for at least thirty minutes.
2. Inspect burner and pilot for dust and dirt.

3. Blow air across the ports/slots and holes in the burner.
4. Never insert objects into the pilot tube.

Clean the pilot assembly also. A yellow tip on the pilot flame indicates dust and dirt in the pilot assembly. There is a small pilot air inlet about 2" from where the pilot flame comes out of the pilot assembly (see Figure 26). With the unit off, lightly blow air through the air inlet. You may blow through a drinking straw if compressed air is not available.

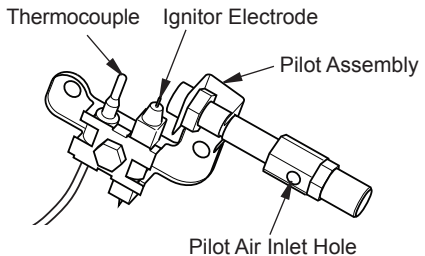

**Figure 26 - Pilot Inlet Air Hole**

### CABINET

#### Air Passageways

Use pressurized air to clean.

#### Exterior

Use a soft cloth dampened with a mild soap and water mixture. Wipe the cabinet to remove dust.

## TROUBLESHOOTING

**⚠ WARNING: If you smell gas:**

- Shut off gas supply.
- Do not try to light any appliance.
- Do not touch any electrical switch; do not use any phone in your building.
- Immediately call your gas supplier from a neighbor's phone. Follow the gas supplier's instructions.
- If you cannot reach your gas supplier, call the fire department.

**⚠ WARNING: Only a qualified service technician should service and repair heater. Make sure that power is turned off before proceeding. Turn off and let cool before servicing.**

*IMPORTANT:* Operating heater where impurities in air exist may create odors. Cleaning supplies, paint, paint remover, cigarette smoke, cements and glues, new carpet or textiles, etc., create fumes. These fumes may mix with combustion air and create odors.

*Note: All troubleshooting items are listed in order of operation.*

Problem	Possible Cause	Corrective Action
When ignitor button is pressed in, there is no spark at ODS/pilot.	<ol style="list-style-type: none"> <li>1. Bad piezo ignitor.</li> <li>2. Ignitor electrode is not connected to ignitor cable.</li> <li>3. Ignitor cable is pinched or wet.</li> <li>4. Ignitor electrode is positioned wrong. Ignitor electrode is broken.</li> <li>5. Broken ignitor cable.</li> </ol>	<ol style="list-style-type: none"> <li>1. Replace piezo ignitor.</li> <li>2. Replace ignitor cable.</li> <li>3. Free ignitor cable if pinched by any metal or tubing. Keep ignitor cable dry.</li> <li>4. Replace pilot assembly.</li> <li>5. Replace ignitor cable.</li> </ol>
When ignitor button is pressed in there is a spark at ODS/pilot but no ignition.	<ol style="list-style-type: none"> <li>1. Gas supply is turned off or equipment shutoff valve is closed.</li> <li>2. Control knob not in PILOT position.</li> <li>3. Control knob not fully pressed in while pressing ignitor button.</li> <li>4. Air in gas lines when installed.</li> <li>5. ODS / pilot is clogged.</li> <li>6. Incorrect inlet gas pressure or inlet regulator is damaged.</li> <li>7. Depleted gas supply (propane).</li> </ol>	<ol style="list-style-type: none"> <li>1. Turn on gas supply or open equipment shutoff valve.</li> <li>2. Turn control knob to PILOT position.</li> <li>3. Fully press in control knob while pressing ignitor button.</li> <li>4. Continue holding down control knob. Repeat igniting operation until air is removed.</li> <li>5. Clean ODS/pilot (see <i>Care and Maintenance</i>, page 20) or replace ODS/pilot assembly.</li> <li>6. Check inlet gas pressure or replace inlet gas regulator.</li> <li>7. Contact local propane gas company.</li> </ol>

## TROUBLESHOOTING

Problem	Possible Cause	Corrective Action
ODS/pilot lights but flame goes out when control knob is released.	<ol style="list-style-type: none"> <li>1. Control knob is not fully pressed in.</li> <li>2. Control knob is not pressed in long enough.</li> <li>3. Equipment shutoff valve is not fully open.</li> <li>4. Thermocouple connection is loose at control valve.</li> <li>5. Pilot flame not touching thermocouple, which allows thermocouple to cool, causing pilot flame to go out. This problem could be caused by one or both of the following: A) Low gas pressure B) Dirty or partially clogged ODS/pilot</li> <li>6. Thermocouple damaged.</li> <li>7. Control valve damaged.</li> </ol>	<ol style="list-style-type: none"> <li>1. Press in control knob fully.</li> <li>2. After ODS/pilot lights, keep control knob pressed in 30 seconds.</li> <li>3. Fully open equipment shutoff valve.</li> <li>4. Hand tighten until snug, and then tighten 1/4 turn more.</li> <li>5. A) Contact local natural or propane gas company  B) Clean ODS/pilot (see <u>Care and Maintenance</u>, page 20) or replace ODS/pilot assembly</li> <li>6. Replace thermocouple</li> <li>7. Contact customer service.</li> </ol>
Burner(s) does not light after ODS/pilot is lit.	<ol style="list-style-type: none"> <li>1. Burner orifice is clogged.</li> <li>2. Inlet gas pressure is too low.</li> <li>3. Burner orifice diameter is too small.</li> </ol>	<ol style="list-style-type: none"> <li>1. Clean burner orifice (see <u>Care and Maintenance</u>, page 20) or replace burner orifice.</li> <li>2. Contact local gas supplier.</li> <li>3. Contact customer service.</li> </ol>
Delayed ignition of burner(s).	<ol style="list-style-type: none"> <li>1. Manifold pressure is too low.</li> <li>2. Burner orifice is clogged.</li> </ol>	<ol style="list-style-type: none"> <li>1. Contact local gas supplier.</li> <li>2. Clean burner (see <u>Care and Maintenance</u>, page 20).</li> </ol>
Burner backfiring during combustion.	<ol style="list-style-type: none"> <li>1. Burner orifice is clogged or damaged.</li> <li>2. Gas regulator is damaged.</li> </ol>	<ol style="list-style-type: none"> <li>1. Clean burner orifice (see <u>Care and Maintenance</u>, page 20).</li> <li>2. Contact customer service.</li> </ol>
Burner plaque(s) does not glow.	<ol style="list-style-type: none"> <li>1. Plaque is damaged.</li> <li>2. Inlet gas pressure is too low.</li> <li>3. Control knob set between locked positions.</li> </ol>	<ol style="list-style-type: none"> <li>1. Replace burner.</li> <li>2. Contact local gas company.</li> <li>3. Turn control knob until it locks at desired setting.</li> </ol>
Slight smoke or odor during initial operation.	<ol style="list-style-type: none"> <li>1. Residues from manufacturing process.</li> </ol>	<ol style="list-style-type: none"> <li>1. Problem will stop after a few hours of operation.</li> </ol>
Gas odor during combustion.	<ol style="list-style-type: none"> <li>1. Foreign matter between control valve and burner.</li> <li>2. Gas leak. (See <u>Warning Statement</u> at top of page 21).</li> </ol>	<ol style="list-style-type: none"> <li>1. Take apart gas tubing and remove foreign matter.</li> <li>2. Locate and correct all leaks (see <u>Checking Gas Connections</u>, page 15).</li> </ol>

## TROUBLESHOOTING

Problem	Possible Cause	Corrective Action
Heater produces unwanted odors.	<ol style="list-style-type: none"> <li>1. Heater is burning vapors from paint, hair spray, glues, etc. See <b>IMPORTANT</b> statement, page 21.</li> <li>2. Gas leak. See <i>Warning Statement</i> at the top of page 21.</li> <li>3. Low fuel supply (propane gas only).</li> </ol>	<ol style="list-style-type: none"> <li>1. Ventilate room. Stop using odor causing products while heater is running.</li> <li>2. Locate and correct all leaks (see <i>Checking Gas Connections</i>, page 15).</li> <li>3. Refill supply tank (Propane models).</li> </ol>
Heater produces a clicking/ticking noise just after burner is lit or shut off.	<ol style="list-style-type: none"> <li>1. Metal is expanding while heating or contracting while cooling.</li> </ol>	<ol style="list-style-type: none"> <li>1. This is common with most heaters. If noise is excessive, contact qualified service technician.</li> </ol>
White powder residue forming within burner box or on adjacent walls or furniture.	<ol style="list-style-type: none"> <li>1. When heated, the vapors from furniture polish, wax, carpet cleaners, etc., turn into white powder residue.</li> </ol>	<ol style="list-style-type: none"> <li>1. Turn heater off when using furniture polish, wax, carpet cleaner or similar products.</li> </ol>
Heater shuts off in use (ODS operates).	<ol style="list-style-type: none"> <li>1. Not enough fresh air is available.</li> <li>2. Low line pressure.</li> <li>3. ODS/pilot is partially clogged.</li> </ol>	<ol style="list-style-type: none"> <li>1. Open window and/or door for ventilation.</li> <li>2. Contact local gas supplier.</li> <li>3. Clean ODS/pilot (see <i>Care and Maintenance</i>, page 18).</li> </ol>
Gas odor exists even when control knob is in OFF position.	<ol style="list-style-type: none"> <li>1. Gas leak. See <i>Warning Statement</i> at top of page 21.</li> <li>2. Control valve is defective.</li> </ol>	<ol style="list-style-type: none"> <li>1. Locate and correct all leaks (see <i>Checking Gas Connections</i>, page 15).</li> <li>2. Contact customer service.</li> </ol>
Moisture/condensation noticed on windows.	<ol style="list-style-type: none"> <li>1. Not enough combustion/ventilation air.</li> </ol>	<ol style="list-style-type: none"> <li>1. Refer to <i>Air for Combustion and Ventilation</i> requirements, page 7.</li> </ol>

## PARTS

### MODEL ML100HBAHR

This list contains replaceable parts for your heater. When ordering replacement parts, follow the instructions listed under Replacement Parts on page 26 of this manual.

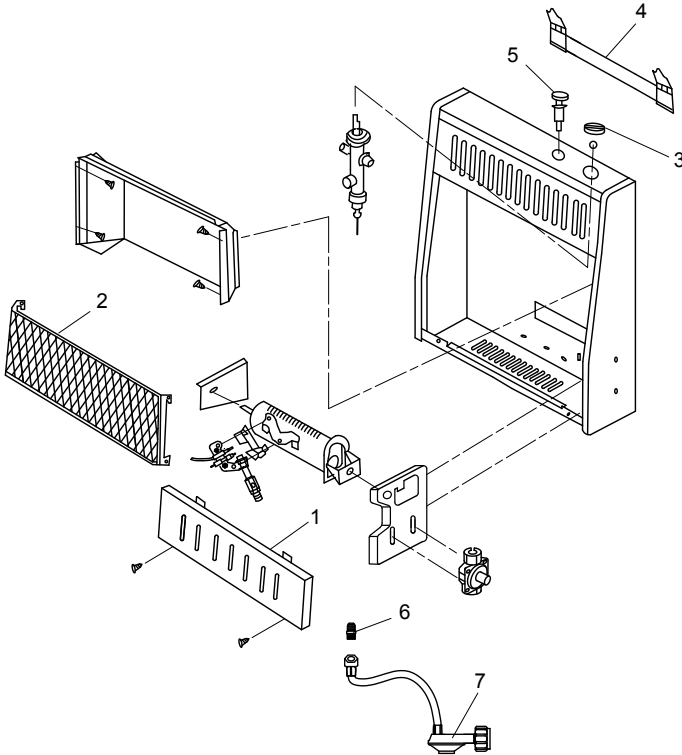

ITEM	PART #	DESCRIPTION	QTY
1	MB09003	Lower Front Panel Assembly	1
2	MB29003	Grill Guard	1
3	MB16002	Control Knob Assembly	1
4	161132-01	Mounting Bracket Assembly	1
5	ML083-03	Ignitor Assembly	1
6	PL023-01	Connector	1
7	NR02-02	Hose/Regulator Assembly	1
<b>PARTS AVAILABLE - NOT SHOWN</b>			
	161607-01	Hardware Package	1



## PARTS

### MODEL ML100TBAHR

This list contains replaceable parts for your heater. When ordering replacement parts, follow the instructions listed under Replacement Parts on page 26 of this manual.

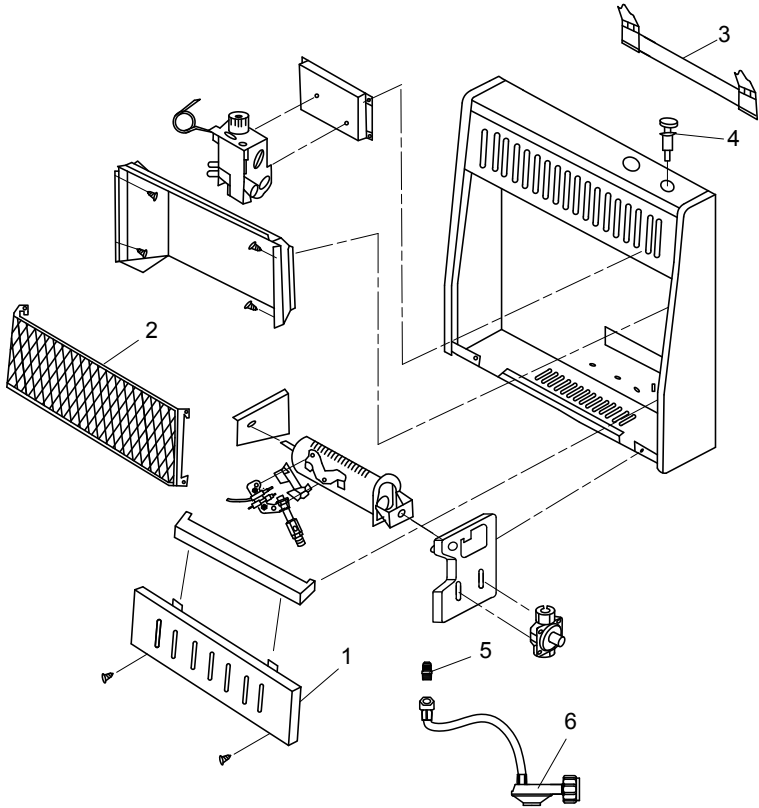

ITEM	PART #	DESCRIPTION	QTY
1	MB09003	Lower Front Panel Assembly	1
2	MB29003	Grill Guard	1
3	161132-01	Mounting Bracket Assembly	1
4	ML083-03	Ignitor Assembly	1
5	PL023-01	Connector	1
6	NR02-02	Hose/Regulator Assembly	1
<b>PARTS AVAILABLE - NOT SHOWN</b>			
	161607-01	Hardware Package	1

---

---

## REPLACEMENT PARTS

---

---

*Note: Use only original replacement parts. This will protect your warranty coverage for parts replaced under warranty.*

### **PARTS UNDER WARRANTY**

Contact authorized dealers of this product. If they can't supply original replacement parts, call Customer Service toll free at 1-866-573-0674 for referral information.

When calling Customer Service or your dealer, have ready:

- Your name
- Your address
- Model and serial number of your heater
- How heater was malfunctioning
- Type of gas used (Propane or Natural gas/NG)
- Purchase date

Usually, we will ask you to return the defective part to the factory

### **PARTS NOT UNDER WARRANTY**

Contact authorized dealers of this product. If they can't supply original replacement part(s) call Customer Service toll free at 1-866-573-0674 for referral information.

When calling Customer Service have ready:

- Model number of your heater
- The replacement part number

---

---

## ACCESSORIES

---

---

Purchase these heater accessories from your local dealer. If they can not supply these accessories, contact ProCom Heating, Inc. at 1-866-573-0674 for information.

### **EQUIPMENT SHUTOFF VALVE**

For all models. Equipment shutoff valve with 1/2" NPT tap.

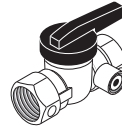

---

---

## SERVICE HINTS

---

---

### **When Gas Pressure Is Too Low**

- pilot will not stay lit
  - burners will have delayed ignition
  - fireplace will not produce specified heat
- propane gas supply might be low (propane units only)
- You may feel your gas pressure is too low. If so, contact your local gas supplier.

---

---

## TECHNICAL SERVICE

---

---

You may have further questions about installation, operation, or troubleshooting. If so, contact ProCom Heating, Inc. at 1-866-573-0674.

When calling, please have your model and serial numbers of your heater ready.

---

---

# WARRANTY

---

---

## KEEP THIS WARRANTY

Model \_\_\_\_\_

Serial No. \_\_\_\_\_

Date Purchased \_\_\_\_\_

Keep receipt for warranty verification.

## REGISTER YOUR PRODUCT AT [WWW.USAPROCOM.COM](http://WWW.USAPROCOM.COM)

**IMPORTANT: We urge you to register your product within 10 days of date of installation, complete with entire serial number which can be found on the rating plate. Please fill out the warranty information above for your personal records. Retain this manual for future reference.**

Always specify model and serial numbers when communicating with customer service.

We reserve the right to amend these specifications at any time without notice. The only warranty applicable is our standard written warranty. We make no other warranty, expressed or implied.

## NEW PRODUCTS

**Standard Warranty:** ProCom Heating, Inc. warrants this product to be free from defects in materials and components for ONE (1) year from the date of first purchase, provided that the product has been properly installed by a qualified installer in accordance with all local codes and instructions furnished with the unit, operated and maintained in accordance with all applicable instructions. To make a claim under this warranty, the Bill of Sale or canceled check must be presented.

## FACTORY RECONDITIONED PRODUCTS

**Limited Warranty:** ProCom Heating, Inc. warrants factory reconditioned products and any parts thereof to be free from defects in material and workmanship for a period 30 days from the date of first purchase from an authorized dealer provided the product has been installed, maintained and operated in accordance with ProCom Heating, Inc.'s warnings and Instructions. No return will be authorized. Parts will be provided to repair the product.

## RESPONSIBILITY OF OWNER

This warranty is extended only to the original retail purchaser. This warranty covers the cost of part(s) required to restore this heater to proper operating condition. Warranty part(s) MUST be obtained through ProCom Heating, Inc. who will provide original factory replacement parts. Failure to use original factory replacement parts voids this warranty.

**IMPORTANT: The heater MUST be installed by a qualified installer in accordance with all local codes and instructions furnished with the unit or the warranty is voided.**

## WHAT IS NOT COVERED

This warranty does not apply to parts that are not in original condition because of normal wear and tear or parts that fail or become damaged as a result of misuse, accidents, lack of proper maintenance or defects caused by improper installation. Travel, diagnostic cost, labor, transportation and any and all such other costs related to repairing a defective heater will be the responsibility of the owner.

TO THE FULL EXTENT ALLOWED BY THE LAW OF THE JURISDICTION THAT GOVERNS THE SALE OF THE PRODUCT, THIS EXPRESS WARRANTY EXCLUDES ANY AND ALL OTHER EXPRESSED WARRANTIES AND LIMITS THE DURATION OF ANY AND ALL IMPLIED WARRANTIES. INCLUDING WARRANTIES OF MERCHANTABILITY AND FITNESS FOR A PARTICULAR PURPOSE TO ONE (1) YEARS ON ALL COMPONENTS FROM THE DATE OF FIRST PURCHASE. PROCOM HEATING, INC.'S LIABILITY IS HEREBY LIMITED TO THE PURCHASE PRICE OF THE PRODUCT AND PROCOM HEATING, INC. SHALL NOT BE LIABLE FOR ANY OTHER DAMAGES WHATSOEVER INCLUDING INDIRECT, INCIDENTAL OR CONSEQUENTIAL DAMAGES.

Some states do not allow a limitation on how long an implied warranty lasts or an exclusion or limitation of accidental or consequential damages, the above limitation on implied warranties, or exclusion or limitation on damages may not apply to you.

This warranty gives you specific legal right, and you may also have other rights that vary from state to state.



ProCom Heating, Inc.  
Bowling Green, KY 42101  
[www.usaprocom.com](http://www.usaprocom.com)  
1-866-573-0674

200052-01  
Rev. C  
04/19