

**BLUE FLAME
VENT-FREE PROPANE/LP GAS
SPACE HEATER
OWNER'S OPERATION AND
INSTALLATION MANUAL**

**MODELS
ML060HBA, ML100HBA
ML100TBA**



⚠ WARNING: If the information in this manual is not followed exactly, a fire or explosion may result causing property damage, personal injury or loss of life.

- Do not store or use gasoline or other flammable vapors and liquids in the vicinity of this or any other appliance.
- **WHAT TO DO IF YOU SMELL GAS**
 - Do not try to light any appliance.
 - Do not touch any electrical switch; do not use any phone in your building.
 - Immediately call your gas supplier from a neighbor's phone. Follow the gas supplier's instructions.
 - If you cannot reach your gas supplier, call the fire department.
- Installation and service must be performed by a qualified installer, service agency or the gas supplier.

INSTALLER: Leave this manual with the appliance.
CONSUMER: Retain this manual for future reference.



Questions, problems, missing parts? Before returning to your retailer, call our customer service department at 1-866-573-0674, 7:30 am - 4:15 pm CST, Monday through Friday or email customerservice@usaprocom.com

TABLE OF CONTENTS

Safety	3	Operation.....	14
Specifications	4	Inspecting Heater	17
Product Identification	5	Care And Maintenance	18
Qualified Installing Agency	5	Troubleshooting	19
Product Features	5	Parts	22
Air For Combustion and Ventilation	6	Replacement Parts	28
Local Codes.....	6	Accessories	28
Unpacking.....	6	Service Hints	29
Water Vapor: A By-Product Of		Technical Service.....	29
Unvented Room Heaters	6	Warranty	32
Installation	8		

SAVE THIS BOOK

This is an unvented gas-fired heater. It uses air (oxygen) from the room in which it is installed. Provisions for adequate combustion and ventilation air must be provided. Refer to *Air For Combustion and Ventilation* section on page 6 of this manual.

 **WARNING: Improper installation, adjustment, alteration, service or maintenance can cause injury or property damage. Refer to this manual for correct installation and operational procedures. For assistance or additional information consult a qualified installer, service agency or the gas supplier.**

This appliance may be installed in an aftermarket,* permanently located, manufactured (mobile) home, where not prohibited by local codes.

This appliance is only for use with the type of gas indicated on the rating plate. This appliance is not convertible for use with other gases.

* Aftermarket: Completion of sale, not for purpose of resale, from the manufacturer.

SAFETY

IMPORTANT: Read this owner's manual carefully and completely before trying to assemble, operate, or service this heater. Improper use of this heater can cause serious injury or death from burns, fire, explosion, electrical shock and carbon monoxide poisoning.

Only a qualified installer, service agent, or local gas supplier may install and service this product.

⚠ WARNING: Keep the appliance area clear and free from combustible materials, gasoline, and other flammable vapors and liquids.

This heater is equipped for propane/LP gas. Field conversion is not permitted.

This appliance is only for use with the type of gas indicated on the rating plate. This appliance is not convertible for use with other gases.

⚠ DANGER: Carbon monoxide poisoning may lead to death!

CARBON MONOXIDE POISONING: Early signs of carbon monoxide poisoning resemble the flu, with headaches, dizziness or nausea. If you have these signs, the heater may not be working properly. Get fresh air at once! Have heater serviced. Some people are more affected by carbon monoxide than others. These include pregnant women, people with heart or lung disease or anemia, those under the influence of alcohol and those at high altitudes.

PROPANE/LP GAS: Propane/LP gas is odorless. An odor-making agent is added to the gas. The odor helps you detect a gas leak. However, the odor added to the gas can fade. Gas may be present even though no odor exists.

⚠ WARNING: Any change to this heater or its controls can be dangerous.

⚠ WARNING: Do not use any accessories not approved for use with this heater.

⚠ WARNING: Carefully supervise young children when they are in the room with the heater.

⚠ WARNING: Make sure grill guard is in place before running heater.

⚠ WARNING: Due to high temperatures, the appliance should be located out of traffic and away from furniture and draperies.

⚠ WARNING: Heater becomes very hot when operating. Keep children and adults away from hot surfaces to avoid burns or clothing ignition. Heater will remain hot for a time after shutoff. Allow surfaces to cool before touching.

⚠ WARNING: Do not place clothing or other flammable material on or near the appliance. Never place any objects in the heater.

SAFETY

1. Do not place Propane/LP supply tank(s) inside any structure. Propane/LP supply tank(s) must be placed outdoors.
2. Heaters with a maximum input over 6,000 Btu/Hr shall not be installed in a bathroom. Heaters with a maximum input over 10,000 Btu/Hr shall not be installed in a bedroom.
3. This heater needs fresh air ventilation to run properly. This heater has an Oxygen Depletion Sensing (ODS) safety shutoff system. The ODS shuts down the heater if not enough fresh air is available. See [Air for Combustion and Ventilation](#), pages 6 and 7. If heater keeps shutting off, see [Troubleshooting](#), page 19.
4. Keep all air openings in front and bottom of heater clear and free of debris. This will ensure enough air for proper combustion.
5. If heater shuts off, do not relight until you have provided fresh, outside air. If heater keeps shutting off, have it serviced.
6. Do not run heater:
 - Where flammable liquids or vapors are used or stored.
 - Under dusty conditions.
7. Always run heater with control knob at PILOT/IGN, LOW or HIGH locked positions. Never set control knob between locked positions. Poor combustion and higher levels of carbon monoxide may result.
8. Before using furniture polish, wax, carpet cleaner, or similar products, turn heater off. If heated, the vapors from these products may create a white powder residue within burner box or on adjacent walls or furniture.
9. Do not use heater if any part has been under water. Immediately call a qualified service technician to inspect the room heater and to replace any part of the control system and any gas control which has been under water.
10. Turn off heater and let cool before servicing. Only a qualified service person should service and repair heater.
11. Operating heater above elevations of 4,500 feet could cause pilot outage.
12. To prevent performance problems, do not use propane/LP fuel tank of less than 100 lbs. capacity.

SPECIFICATIONS

MODEL	ML060HBA	ML100HBA	ML100TBA
Ignition	Piezo	Piezo	Piezo
Gas Type	Propane/LP Gas	Propane/LP Gas	Propane/LP Gas
BTU (available)	6,000	6,000/10,000	10,000
Pressure Regulator Setting	8" W.C.	8" W.C.	8" W.C.
Inlet Gas Pressure* (inches of water)	Maximum 14"	Maximum 14"	Maximum 14"
	Minimum 11"	Minimum 11"	Minimum 11"
Heater Weight	13 lbs	13 lbs	14 lbs
Shipping Weight	16 lbs	16 lbs	17 lbs
Heater Dimensions (HxWxD)		19 1/8" × 14 1/8" × 6 3/8"	
Carton Dimensions (HxWxD)		22" × 16 3/4" × 8 1/8"	

Note: Dimensions listed are outer most points on the heater (includes control knobs and grill).

* For purposes of input adjustment.

PRODUCT IDENTIFICATION

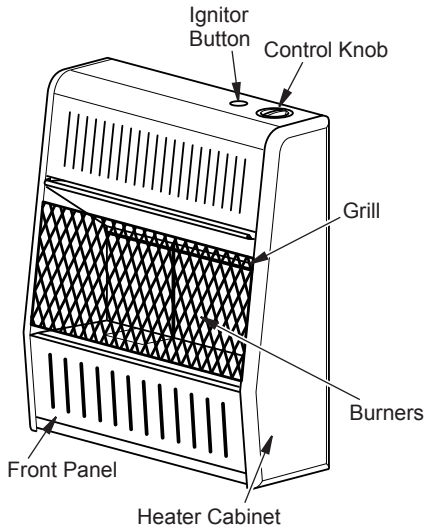

Figure 1 - Vent-Free Gas Heater

QUALIFIED INSTALLING AGENCY

Only a qualified agency should install and replace gas piping, gas utilization equipment or accessories, and repair and equipment servicing. The term “qualified agency” means any individual, firm, corporation, or company that either in person or through a representative is engaged in and is responsible for:

- a) Installing, testing, or replacing gas piping or
- b) Connecting, installing, testing, repairing, or servicing equipment; that is experienced in such work; that is familiar with all precautions required; and that has complied with all the requirement of the authority having jurisdiction.

PRODUCT FEATURES

SAFETY PILOT

This heater has a pilot with an Oxygen Depletion Sensing (ODS) safety shutoff system. The ODS/pilot shuts off the heater if there is not enough fresh air.

PIEZO IGNITION SYSTEM

This heater is equipped with a piezo ignitor. this system requires no matches, batteries, or other sources to light heater.

THERMOSTATIC CONTROL

(Thermostat Models Only)

These heaters have a control valve with a thermostat sensing bulb. This results in the greatest heater comfort and may result in lower gas bills.

LOCAL CODES

Install and use heater with care. Follow all local codes. In the absence of local codes, use the latest edition of *The National Fuel Gas Code, ANSI Z223.1/NFPA 54**.

*Available from:

American National Standards Institute, Inc.
25 West 43rd Street
New York, NY 10036

National Fire Protection Association, Inc.
1 Batterymarch Park
Quincy, MA 02269-9101

State of Massachusetts: The installation must be made by a licensed plumber or gas fitter in the Commonwealth of Massachusetts.

Sellers of unvented propane or natural gas-fired supplemental room heaters shall provide to each purchaser a copy of 527 CMR 30 upon sale of the unit.

In the State of Massachusetts the gas cock must be a T-handle type. The State of Massachusetts requires that a flexible appliance connector cannot exceed three feet in length.

UNPACKING

1. Remove heater from carton.
2. Remove all protective packaging applied to heater for shipping
3. Check heater for any shipping damage. If heater is damaged, promptly inform dealer where you bought heater.

WATER VAPOR: A BY-PRODUCT OF UNVENTED ROOM HEATERS

Water vapor is a by-product of gas combustion. An unvented room heater produces approximately one (1) ounce (30 mL) of water for every 1,000 BTUs (0.3 KWs) of gas input per hour. Unvented room heaters are recommended as supplemental heat (a room) rather than a primary heat source (an entire house). In most supplemental heat applications, the water vapor does not create a problem. In most applications, the water vapor enhances the low humidity atmosphere experienced during cold weather.

The following steps will help ensure that water vapor does not become a problem.

1. Be sure the heater is sized properly for the application, including ample combustion air and circulation air.
2. If high humidity is experienced, a dehumidifier may be used to help lower the water vapor content of the air.
3. Do not use an unvented room heater as the primary heat source.

AIR FOR COMBUSTION AND VENTILATION

 **WARNING: This heater shall not be installed in a confined space or unusually tight construction unless provisions are provided for adequate combustion and ventilation air. Read the following instructions to insure proper fresh air for this and other fuel-burning appliances in your home.**

Today's homes are built more energy efficient than ever. New materials, increased insulation and new construction methods help reduce heat loss in homes. Home owners weather strip and caulk around windows and doors to keep the cold air out and the warm air in. During heating months, home owners want their homes as airtight as possible.

While it is good to make your home energy efficient, your home needs to breathe. Fresh air must enter your home. All fuel-burning appliances need fresh air for proper combustion and ventilation.

AIR FOR COMBUSTION AND VENTILATION

Exhaust fans, fireplaces, clothes dryers and fuel burning appliances draw air from the house to operate. You must provide adequate fresh air for these appliances. This will insure proper venting of vented fuel-burning appliances.

⚠ WARNING: This heater shall not be installed in a room or space unless the required volume of indoor combustion air is provided by the method described in the *National Fuel Gas Code, ANSI Z223.1/NFPA 54, the International Fuel Gas Code, or applicable local codes.*

⚠ WARNING: If the area in which the heater may be operated does not meet the required volume for indoor combustion air, combustion and ventilation air shall be provided by one of the methods described in the *National Fuel Gas Code, ANSI Z223.1/NFPA 54, the International Fuel Gas Code, or applicable local codes.*

VENTILATION AIR

Ventilation Air From Inside Building

This fresh air would come from an adjoining unconfined space. When ventilating to an adjoining unconfined space, you must provide two permanent openings: one within 12" of the ceiling and one within 12" of the floor on the wall connecting the two spaces (see options 1 and 2, Figure 2). You can also remove door into adjoining room (see option 3, Figure 2). Follow the *National Fuel Gas Code, ANSI Z223.1/NFPA 54, Air for Combustion and Ventilation* for required size of ventilation grills or ducts.

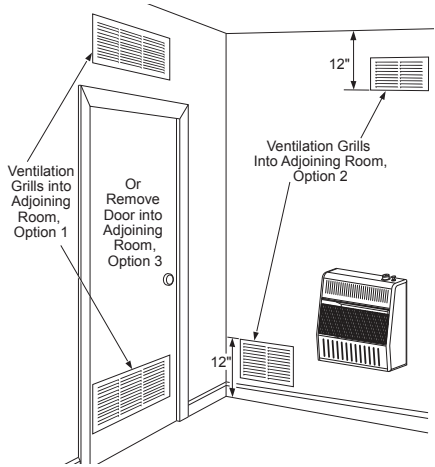

Figure 2 - Ventilation Air from Inside Building

Ventilation Air From Outdoors

Provide extra fresh air by using ventilation grills or ducts. You must provide two permanent openings: one within 12" of the ceiling and one within 12" of the floor. Connect these items directly to the outdoors or spaces open to the outdoors. These spaces include attics and crawl spaces. Follow the *National Fuel Gas Code, ANSI Z223.1/NFPA 54, Air for Combustion and Ventilation* for required size of ventilation grills or ducts.

IMPORTANT: Do not provide openings for inlet or outlet air into attic if attic has a thermostat-controlled power vent. Heated air entering the attic will activate the power vent. Rework worksheet, adding the space of the adjoining unconfined space. The combined spaces must have enough fresh air to supply all appliances in both spaces.

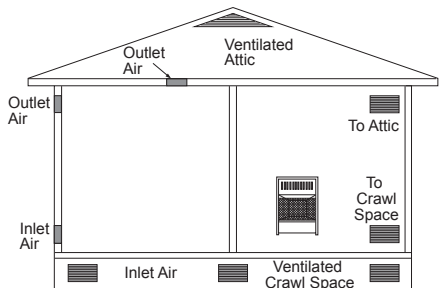

Figure 3 - Ventilation Air from Outdoors

INSTALLATION

NOTICE: This heater is intended for use as supplemental heat. Use this heater along with your primary heating system. Do not install this heater as your primary heat source. If you have a central heating system, you may run system's circulating blower while using heater. This will help circulate the heat throughout the house. In the event of a power outage, you can use this heater as your primary heat source.

CAUTION: When installing heater in a home garage

- heater pilot and burner must be at least 18" above floor
- locate heater where moving vehicle will not hit it

WARNING: A qualified service person must install heater. Follow all local codes.

WARNING: Never install the heater

- Models ML100HBA or ML100TBA in a bathroom
- in a recreational vehicle
- where curtains, furniture, clothing, or other flammable objects are less than 36" from the front, top, or sides of the heater
- in high traffic areas
- in windy or drafty areas

WARNING: MODEL ML060HBA ONLY! When installed in a bathroom, do not use flammable products such as aerosol hair spray or any product that contains flammable vapors. Keep towels and other flammable materials away from heater.

CAUTION: This heater creates warm air currents. These currents move heat to wall surfaces next to heater. Installing heater next to vinyl or cloth wall coverings or operating heater where impurities (such as tobacco smoke, aromatic candles, cleaning fluids, oil or kerosene lamps, etc.) in the air exist, may cause walls to discolor.

IMPORTANT: Vent-free heaters add moisture to the air. Although this is beneficial, installing heater in rooms without enough ventilation air may cause mildew to form too much moisture. See *Air for Combustion and Ventilation*, pages 6 and 7.

CHECK GAS TYPE

Be sure your gas supply is right for your heater. Otherwise, call dealer where you bought the heater for proper type heater.

CLEARANCES TO COMBUSTIBLES

WARNING: Maintain the minimum clearances shown in Figure 4, page 9. If you can, provide greater clearances from floor, ceiling, and joining wall.

INSTALLATION

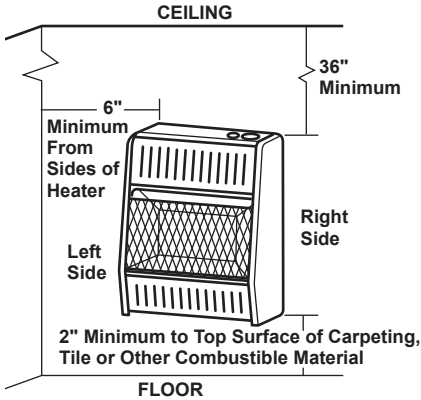

Figure 4 - Mounting Clearances as Viewed From Front of Heater

LOCATING HEATER

This heater is designed to be mounted on a wall. You can locate heater on the floor, away from a wall. An optional floor mounting stand is needed. See *Accessories*, page 28.

For convenience and efficiency, install heater:

1. Where there is easy access for operation, inspection, and service.
2. In the coldest part of room.

An optional fan kit is available from your dealer. See *Accessories*, page 28. If planning to use fan, locate heater near an electrical outlet.

FASTENING HEATER TO WALL Mounting Bracket

The mounting bracket is located on back panel of heater (see Figure 5). It has been taped there for shipping. Remove mounting bracket from back panel.

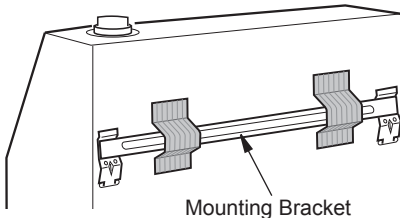

Figure 5 - Mounting Bracket Location

Removing Front Panel of Heater

1. Remove two screws near bottom corners of lower front panel.
2. Pull bottom of lower front panel forward, then down (see Figure 6).

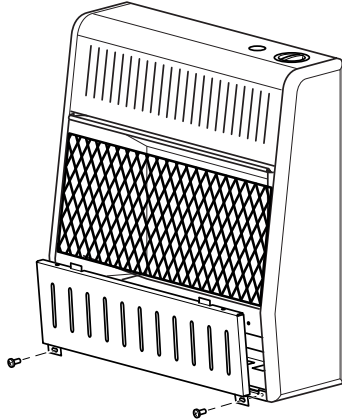

Figure 6 - Removing Front Panel Of Heater

Methods For Attaching Mounting Bracket To Wall

Use only the last hole on each end of mounting bracket to attach bracket to wall. Attach mounting bracket to a wall only in one of two ways:

1. **Attaching to wall stud:** This method provides the strongest hold. Insert mounting screws through mounting bracket and into wall studs.
2. **Attaching to wall anchor:** This method allows you to attach mounting bracket to hollow walls (wall areas between studs) or to solid walls (concrete or masonry).

Decide which method better suits your needs. Either method will provide a secure hold for the mounting bracket.

INSTALLATION

Marking Screw Locations

1. Tape mounting bracket to wall where heater will be located. Make sure mounting bracket is level.

⚠ WARNING: Maintain minimum clearances shown in Figure 4, page 9. If you can, provide greater clearances from floor and joining wall.

2. Mark screw locations on wall (see Figure 7). *Note: Mark only last hole on each end of mounting bracket. Insert mounting screws through these holes only.*
3. Remove tape and mounting bracket from wall.

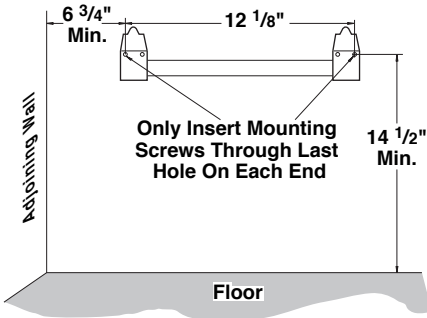

Figure 7 - Mounting Bracket Clearances

Attaching Mounting Bracket To Wall

Note: Wall anchors, mounting screws, and spacers are in hardware package. The hardware package is provided with heater.

Attaching to Wall Stud Method

For attaching mounting bracket to wall studs:

1. Drill holes at marked locations using 9/64" drill bit.
2. Place mounting bracket onto wall. Line up last hole on each end of bracket with holes drilled in wall.
3. Insert mounting screws through bracket and into wall studs.
4. Tighten screws until mounting bracket is firmly fastened to wall studs.

Attaching to Wall Anchor Method

For attaching mounting bracket to hollow walls (wall areas between studs) or solid walls (concrete or masonry):

1. Drill holes at marked locations using 5/16" drill bit. For solid walls (concrete or masonry), drill at least 1" deep.
2. Fold wall anchor as shown in Figure 8.
3. Insert wall anchor (wings first) into hole. Tap anchor flush to wall.
4. For thin walls (1/2" or less), insert red key into wall anchor. Push red key to "pop" open anchor wings (see Figure 9).

IMPORTANT: Do not hammer anchor key! For thick walls (over 1/2" thick) or solid walls, do not pop open wings.

5. Place mounting bracket onto wall. Line up last hole on each end of bracket with wall anchors.
6. Insert mounting screws through bracket and into wall anchors.
7. Tighten screws until mounting bracket is firmly fastened to wall.

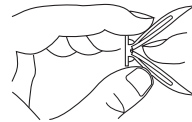

Figure 8 - Folding Anchor

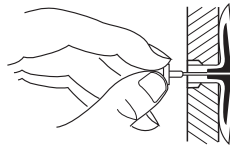

Figure 9 - Popping Open Anchor Wings For Thin Walls

Placing Heater On Mounting Bracket

1. Locate two horizontal slots on back panel of heater (see Figure 10).
2. Place heater onto mounting bracket. Slide horizontal slots onto stand-out tabs on mounting bracket.

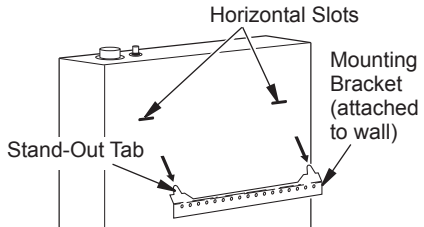

Figure 10 - Mounting Heater Onto Mounting Bracket

INSTALLATION

Installing Bottom Mounting Bracket

1. Install bottom bracket to heater bottom with two screws. It may be more convenient to remove heater from wall bracket to attach.
2. Place heater on wall mounting bracket.
3. Mark screw locations on wall.
4. Remove heater from mounting bracket.
5. If installing bottom mounting screws into hollow or solid wall, install wall anchors. Follow steps 1 through 4 under *Attaching To Wall Anchor Method*, page 10. If installing bottom mounting screw into wall stud, drill holes at marked locations using 9/64" drill bit.
6. Replace heater onto mounting bracket.
7. Place spacers between bottom mounting holes and wall anchor or drilled hole.
8. Hold spacer in place with one hand. With other hand, insert mounting screw through bottom mounting hole and spacer. Place tip of screw in opening of wall anchor or drilled hole.

9. Tighten both screws until heater is firmly secured to wall. Do not over tighten.

Note: Do not replace front panel at this time. Replace front panel after making gas connections and checking for leaks.

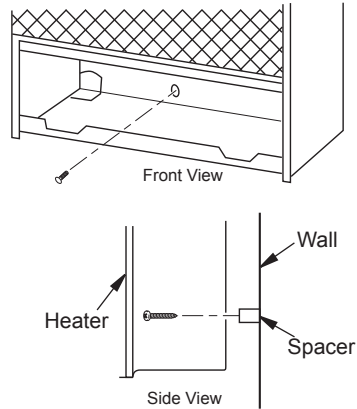

Figure 11 - Installing Bottom Mounting Screws

CONNECTING TO GAS SUPPLY

⚠ WARNING: A qualified service technician must connect heater to gas supply. Follow all local codes.

⚠ WARNING: This appliance requires a 3/8" NPT (National Pipe Thread) inlet connection to the pressure regulator.

⚠ WARNING: Do not over-tighten gas connections.

⚠ CAUTION: Use only new, black iron or steel pipe. Internally tinned copper tubing may be used in certain areas. Check your local codes. Use pipe of 1/2" diameter or greater to allow proper gas volume to heater. If pipe is too small, undue loss of pressure will occur.

⚠ CAUTION: Never connect heater directly to the gas supply. This heater requires an external regulator (not supplied). Install the external regulator between the heater and gas supply. Gas supplier provides external regulator for natural gas. The installer provides the external regulator for propane/LP gas.

⚠ CAUTION: Avoid damage to regulator. Hold gas regulator with wrench when connecting into gas piping and/or fittings.

⚠ CAUTION: Use pipe joint sealant that is resistant to propane/LP gas.

INSTALLATION

Before installing heater, make sure you have the items listed below:

- external regulator for propane/LP unit only (supplied by installer)
- piping (check local codes)
- sealant (resistant to natural gas and propane/LP gas)
- equipment shutoff valve*
- test gauge connection*
- sediment trap
- tee joint
- pipe wrench
- flexible gas hose (check local codes)

* A CSA design-certified equipment shutoff valve with 1/8" NPT tap is an acceptable alternative to test gauge connection. Purchase the optional CSA design certified equipment shutoff valve from your dealer.

Typical Inlet Pipe Diameters

Models up to 20,000 BTU/hr use 3/8" black iron pipe or greater. Models 25,000 BTU/hr and higher use 1/2" black iron pipe or greater. Installation must include an equipment shutoff

valve, union, and plugged 1/8" NPT tap. Locate NPT tap within reach for test gauge hook up. NPT tap must be upstream from heater (see Figure 12).

IMPORTANT: Install an equipment shutoff valve in an accessible location. The equipment shutoff valve is for turning on or shutting off the gas to the appliance.

Apply pipe joint sealant lightly to male threads. This will prevent excess sealant from going into pipe. Excess sealant in pipe could result in clogged heater valves.

The installer must supply an external regulator. The external regulator will reduce incoming gas pressure. You must reduce incoming gas pressure to between 11" and 14" of water. If you do not reduce incoming gas pressure, heater regulator damage could occur. Install external regulator with the vent pointing down as shown in Figure 13. Pointing the vent down protects it from freezing rain or sleet.

Install sediment trap in supply line as shown in Figure 12. Place sediment trap where it is within reach for cleaning. Place sediment trap where trapped matter is not likely to freeze. A sediment trap traps moisture and contaminants. This keeps them from going into heater controls. If sediment trap is not installed or is installed wrong, heater may not run properly.

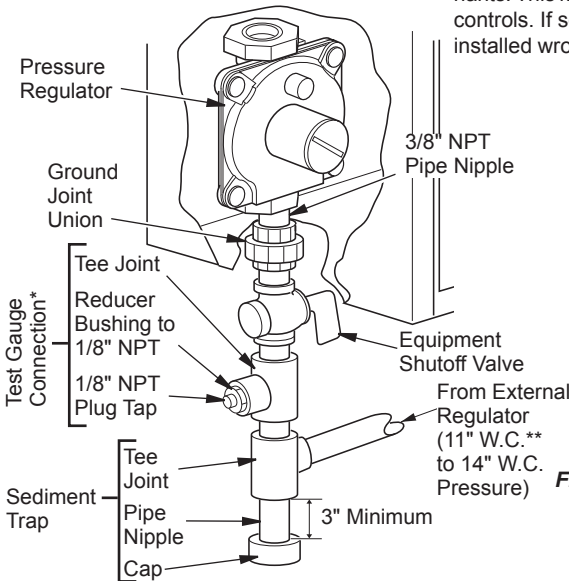

Figure 12 - Gas Connection

* Purchase the optional CSA design-certified equipment shutoff valve from your dealer.

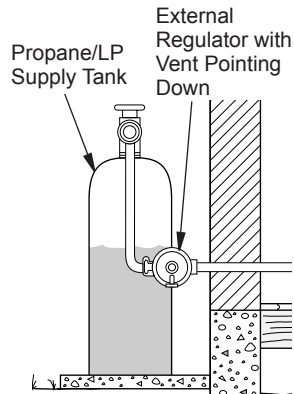

Figure 13 - External Regulator with Vent Pointing Down

INSTALLATION

CHECKING GAS CONNECTIONS

⚠ WARNING: Test all gas piping and connections for leaks after installing or servicing. Correct all leaks at once.

⚠ WARNING: Never use an open flame to check for a leak. Apply a noncorrosive leak detection fluid to all joints. If bubbles form, there is a leak. Correct all leaks at once.

PRESSURE TESTING GAS SUPPLY PIPING SYSTEM

Test Pressures In Excess Of 1/2 PSIG (3.5 kPa)

1. Disconnect heater with its appliance main gas valve (control valve) and equipment shutoff valve from gas supply piping system. Pressures in excess of 1/2 PSIG will damage heater regulator.
2. Cap off open end of gas pipe where equipment shutoff valve was connected.
3. Pressurize supply piping system by either opening propane/LP supply tank valve for propane/LP gas or opening main gas valve located on or near gas meter for natural gas or using compressed air.
4. Check all joints of gas supply piping system. Apply a noncorrosive leak detection fluid to all joints. If bubbles form, there may be a leak.
5. Correct all leaks at once.
6. Reconnect heater and equipment shutoff valve to gas supply. Check reconnected fittings for leaks.

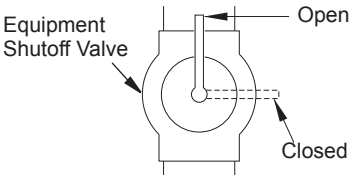

Figure 14 - Equipment Shutoff Valve

Test Pressures Equal To or Less Than 1/2 PSIG (3.5 kPa)

1. Close equipment shutoff valve (see Figure 14).
2. Pressurize supply piping system by either opening main gas valve located on or near gas meter or using compressed air.
3. Check all joints from gas supply to equipment shutoff valve (see Figure 15). Apply a noncorrosive leak detection fluid to all joints. If bubbles form, there is a leak.
4. Correct all leaks at once.

PRESSURE TESTING HEATER GAS CONNECTIONS

1. Open equipment shutoff valve (see Figure 14).
2. Open gas supply tank valve.
3. Make sure control knob of heater is in the OFF position.
4. Check all joints from equipment shutoff valve to control valve (see Figure 15). Apply a noncorrosive leak detection fluid to all joints. Bubbles forming show a leak.
5. Correct all leaks at once.
6. Light heater (see *Operation*, page 14). Check all other internal joints for leaks.
7. Turn off heater (see *To Turn Off Gas Appliance*, page 16).
8. Replace lower front panel.

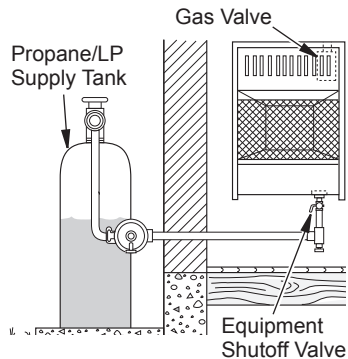

Figure 15 - Checking Gas Joints

OPERATION

FOR YOUR SAFETY READ BEFORE LIGHTING

⚠ WARNING: If you do not follow these instructions exactly, a fire or explosion may result causing property damage, personal injury or loss of life.

- A. This appliance has a pilot which must be lighted by hand. When lighting the pilot, follow these instructions exactly.
- B. **BEFORE LIGHTING** smell all around the appliance area for gas. Be sure to smell next to the floor because some gas is heavier than air and will settle on the floor.
WHAT TO DO IF YOU SMELL GAS
 - Do not try to light any appliance.
 - Do not touch any electric switch; do

- not use any phone in your building.
- Immediately call your gas supplier from a neighbor's phone. Follow the gas supplier's instructions.
- If you cannot reach your gas supplier, call the fire department.

- C. Use only your hand to push in or turn the gas control knob. Never use tools. If the knob will not push in or turn by hand, don't try to repair it, call a qualified service technician. Force or attempted repair may result in a fire or explosion.
- D. Do not use this appliance if any part has been under water. Immediately call a qualified service technician to inspect the appliance and to replace any part of the control system and any gas control which has been under water.

MANUAL CONTROL MODELS LIGHTING INSTRUCTIONS

1. STOP! Read the safety information above.
2. Check that gas supply to heater is on.
3. Push in gas control knob slightly and turn clockwise  to the OFF position.

Note: Knob cannot be turned from PILOT to OFF unless knob is pushed in slightly. Do not force.

4. Wait five (5) minutes to clear out any gas. Then smell for gas, including near the floor. If you smell gas, STOP! Follow "B" in the safety information above. If you do not smell gas, go to the next step.
5. Push in gas control knob slightly and turn counterclockwise  to "PILOT/IGN" and press for five (5) seconds

Note: The first time that the heater is operated after connecting the gas supply, the control knob should be pressed for about thirty (30) seconds. This will allow air to bleed from the gas system.

6. With control knob pressed in, push down and release the ignitor button. This will light pilot. If needed, keep pressing ignitor button until pilot lights.
7. Keep control knob pressed in for 30 seconds after lighting pilot. After 30 seconds, release control knob. If control knob does not pop up when released,

contact a qualified service technician or gas supplier for repairs.

Note: If pilot goes out, repeat steps 3 through 7. This heater has a safety interlock system. Wait one (1) minute before lighting pilot again.

8. To select the desired heating level, partially press down the control knob slightly and turn counterclockwise . Release downward pressure on the knob while

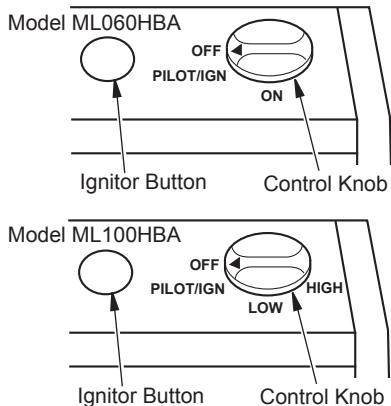

Figure 16 - Control Knob in the OFF Position

OPERATION

continuing to turn until the knob locks at the desired setting. The main burner should light. Set control knob to the desired heating position.

Note: Both HIGH and LOW are locked positions. You must press in the control knob before turning it from these positions.

⚠ CAUTION: Do not try to adjust heating levels by using the equipment shutoff valve.

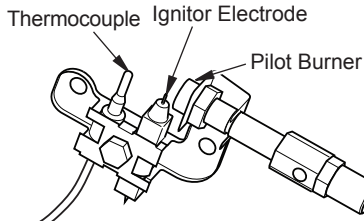

Figure 17 - Pilot

THERMOSTAT MODELS LIGHTING INSTRUCTIONS

1. STOP! Read the safety information on page 14.
2. Make sure equipment shutoff valve is fully open.
3. Turn control knob clockwise ↻ to the OFF position.
4. Wait five (5) minutes to clear out any air. Then smell for gas, including near the floor. If you smell gas, STOP! Follow "B" in the safety information, page 14. If you do not smell gas, go to the next step.
5. Turn control knob counterclockwise ↻ to the PILOT position. Press in control knob for five (5) seconds (see Figure 19).
Note: The first time that the heater is operated after connecting the gas supply, the control knob should be pressed for about thirty (30) seconds. This will allow air to bleed from the gas system. If pilot does not stay lit, refer to Troubleshooting, pages 19 through 21. Also contact a qualified service technician or gas supplier for repairs. Until repairs are made, light pilot with match.
 - If control knob does not pop up when released, contact a qualified service technician or gas supplier for repairs.
6. With control knob pressed in, push down and release ignitor button. This will light pilot. The pilot is attached to the front of burner. The pilot can be seen through the grill. If needed, keep pressing ignitor button until pilot lights.
Note: If pilot does not stay lit, refer to Troubleshooting, pages 19 through 21.

Also contact a qualified service technician or gas supplier for repairs. Until repairs are made, light pilot with match. To light pilot with match, see Manual Lighting Procedure, page 16.

7. Keep control knob pressed in for 30 seconds after lighting pilot. After 30 seconds, release control knob. If control knob does not pop up when released, contact a qualified service technician or gas supplier for repairs.
Note: If pilot goes out, repeat steps 3 through 7. This heater has a safety interlock system. Wait one (1) minute before lighting pilot again.
8. Turn control knob counterclockwise ↻ to desired heating level. The main burner should light. Set control knob to any heat level between HI and LO.

⚠ CAUTION: Do not try to adjust heating levels by using the equipment shutoff valve.

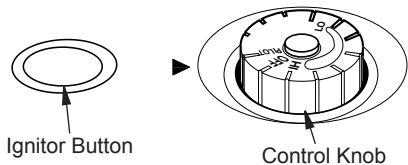

Figure 18 - Control Knob in the OFF Position

OPERATION

THERMOSTAT CONTROL OPERATION

The thermostatic control used on these models differ from standard thermostats. Standard thermostats simply turn the burner on and off. The thermostat used on this heater senses the room temperature. At times the room may exceed the set temperature. If so, the burner will shut off. The burner will cycle back on when room temperature drops below the set temperature. The control knob can be set to any comfort level between HI and LO.

Note: The thermostat sensing bulb measures the temperature of air near the heater cabinet. This may not always agree with room temperature (depending on housing construction, installation location, room size, open air temperatures, etc.) Frequent use of your heater will let you determine your own comfort levels.

ALL MODELS

TO TURN OFF GAS TO APPLIANCE

Shutting Off Heater

Turn control knob clockwise  to the OFF position.

Shutting Off Burner Only (pilot stays lit)

Turn control knob clockwise  to the PILOT position.

MANUAL LIGHTING PROCEDURE

1. Remove lower front panel.
2. Follow steps 1 through 5 under Lighting Instructions, page 14 or 15.
3. With control knob pressed in, strike match. Hold match to pilot until pilot lights.
4. Keep control knob pressed in for 30 seconds after lighting pilot. After 30 seconds, release control knob. Follow step 8 under Lighting Instructions, page 14 or 15.
5. Replace lower front panel.

INSPECTING HEATER

IMPORTANT: Owner's should check pilot flame pattern and burner flame pattern often. Incorrect flame patterns indicate the need for cleaning (see Care and Maintenance, page 18) or service.

⚠ WARNING: Only a qualified service person should service and repair heater. This includes maintenance requiring replacement or alteration of components.

PILOT FLAME PATTERN

Figure 19 shows a correct pilot flame pattern. Figure 20 shows an incorrect pilot flame pattern. The incorrect pilot flame is not touching the thermocouple. This will cause the thermocouple to cool, which shuts the heater off. If pilot flame pattern is incorrect, as shown in Figure 20

- turn heater off (see To Turn Off Gas to Appliance, page 16)
- see Troubleshooting pages 19 through 21.

⚠ WARNING: If yellow tipping occurs, your heater could produce increased levels of carbon monoxide. If the burner flame pattern shows yellow tipping, follow instructions below.

Notice: Do not mistake orange flames with yellow tipping. Dirt or other fine particles enter the heater and burn causing brief patches of orange flame.

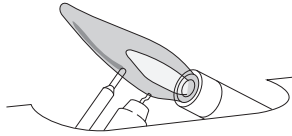

Figure 19 - Correct Pilot Flame Pattern

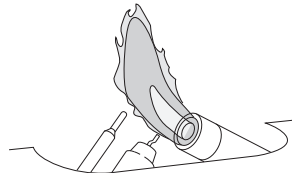

Figure 20 - Incorrect Pilot Flame Pattern

BURNER FLAME PATTERN

Figure 21 shows a correct burner flame pattern. Figure 22 shows an incorrect burner flame pattern. The incorrect burner flame pattern shows yellow tipping of the flame. It also shows the flame higher than 1/2 the heat shield height.

If burner flame pattern is incorrect, as shown in Figure 22

- turn heater off (see To Turn Off Gas to Appliance, page 16)
- see Troubleshooting pages 19 through 21.

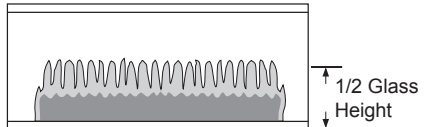

Figure 21 - Correct Burner Flame Pattern

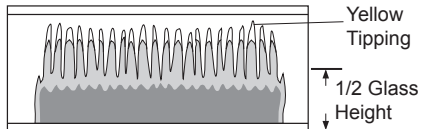

Figure 22 - Incorrect Burner Flame Pattern

CARE AND MAINTENANCE

⚠ WARNING: Turn off heater and let cool before servicing.

⚠ CAUTION: You must keep control areas, burner, and circulating air passageways of heater clean. Inspect these areas of heater before each use. Have heater inspected yearly by a qualified service technician. Heater may need more frequent cleaning due to excessive lint from carpeting, bedding material, pet hair, etc.

⚠ WARNING: Failure to keep the primary air opening(s) of the burner(s) clean may result in sooting and property damage.

ODS/PILOT AND BURNER

⚠ CAUTION: Never use a wire, needle, or similar object to clean ODS/pilot. This can damage ODS/ pilot unit.

Use a vacuum cleaner, pressurized air, or a small, soft bristled brush to clean.

BURNER PILOT AIR INLET

The primary air inlet hole allows the proper amount of air to mix with the gas. This provides a clean burning flame. Keep this hole clear of dust, dirt and lint. Clean this air inlet hole prior to each heating season. A blocked air hole will create soot. We recommend that you clean the unit every three months during operation and have heater inspected yearly by a qualified service person.

We also recommend that you keep the burner tube and pilot assembly clean and free of dust and dirt. To clean these parts we recommend using compressed air no greater than 30 PSI. Your local computer store, hardware store, or home center may carry compressed air in a can. You can use a vacuum cleaner in the blow position. If using compressed air in a can, please follow the directions on the can. If you don't follow directions on the can, you could damage the pilot assembly.

1. Shut off the unit, including the pilot. Allow the unit to cool for at least thirty minutes.
2. Inspect burner and pilot for dust and dirt.

3. Blow air across the ports/slots and holes in the burner.
4. Never insert objects into the pilot tube.

Clean the pilot assembly also. A yellow tip on the pilot flame indicates dust and dirt in the pilot assembly. There is a small pilot air inlet about 2" from where the pilot flame comes out of the pilot assembly (see Figure 23). With the unit off, lightly blow air through the air inlet. You may blow through a drinking straw if compressed air is not available.

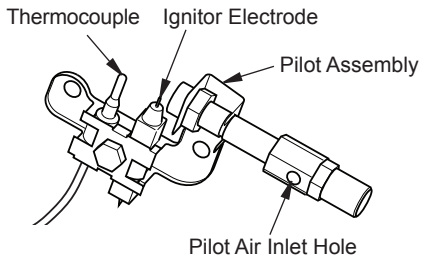

Figure 23 - Pilot Inlet Air Hole

CABINET

Air Passageways

Use pressurized air to clean.

Exterior

Use a soft cloth dampened with a mild soap and water mixture. Wipe the cabinet to remove dust.

TROUBLESHOOTING

⚠ WARNING: If you smell gas:

- Shut off gas supply.
- Do not try to light any appliance.
- Do not touch any electrical switch; do not use any phone in your building.
- Immediately call your gas supplier from a neighbor's phone. Follow the gas supplier's instructions.
- If you cannot reach your gas supplier, call the fire department.

⚠ WARNING: Only a qualified service technician should service and repair heater. Make sure that power is turned off before proceeding. Turn off and let cool before servicing.

IMPORTANT: Operating heater where impurities in air exist may create odors. Cleaning supplies, paint, paint remover, cigarette smoke, cements and glues, new carpet or textiles, etc., create fumes. These fumes may mix with combustion air and create odors.

Note: All troubleshooting items are listed in order of operation.

Problem	Possible Cause	Corrective Action
When ignitor button is pressed in, there is no spark at ODS/pilot.	<ol style="list-style-type: none"> 1. Ignitor electrode is positioned wrong. Ignitor electrode is broken. 2. Ignitor electrode is not connected to ignitor cable. 3. Ignitor cable is pinched or wet. 4. Broken ignitor cable. 5. Bad piezo ignitor. 	<ol style="list-style-type: none"> 1. Replace pilot assembly. 2. Replace ignitor cable. 3. Free ignitor cable if pinched by any metal or tubing. Keep ignitor cable dry. 4. Replace ignitor cable. 5. Replace piezo ignitor.
When ignitor button is pressed in there is a spark at ODS/pilot but no ignition.	<ol style="list-style-type: none"> 1. Gas supply is turned off or equipment shutoff valve is closed. 2. Control knob not fully pressed in while pressing ignitor button. 3. Air in gas lines when installed. 4. ODS / pilot is clogged. 5. Incorrect inlet gas pressure or inlet regulator is damaged. 6. Control knob not in PILOT position. 7. Depleted gas supply (propane). 	<ol style="list-style-type: none"> 1. Turn on gas supply or open equipment shutoff valve. 2. Fully press in control knob while pressing ignitor button. 3. Continue holding down control knob. Repeat igniting operation until air is removed. 4. Clean ODS/pilot (see <i>Care and Maintenance</i>, page 18) or replace ODS/pilot assembly. 5. Check inlet gas pressure or replace inlet gas regulator. 6. Turn control knob to PILOT position. 7. Contact local propane/LP gas company.

TROUBLESHOOTING

Problem	Possible Cause	Corrective Action
ODS/pilot lights but flame goes out when control knob is released.	<ol style="list-style-type: none"> 1. Control knob is not fully pressed in. 2. Control knob is not pressed in long enough. 3. Equipment shutoff valve is not fully open. 4. Thermocouple connection is loose at control valve. 5. Pilot flame not touching thermocouple, which allows thermocouple to cool, causing pilot flame to go out. This problem could be caused by one or both of the following: A) Low gas pressure B) Dirty or partially clogged ODS/pilot 6. Thermocouple damaged. 7. Control valve damaged. 	<ol style="list-style-type: none"> 1. Press in control knob fully. 2. After ODS/pilot lights, keep control knob pressed in 30 seconds. 3. Fully open equipment shutoff valve. 4. Hand tighten until snug, and then tighten 1/4 turn more. 5. A) Contact local natural or propane/LP gas company B) Clean ODS/pilot (see <u>Care and Maintenance</u>, page 18) or replace ODS/pilot assembly 6. Replace thermocouple 7. Replace control valve.
Burner(s) does not light after ODS/pilot is lit.	<ol style="list-style-type: none"> 1. Burner orifice is clogged. 2. Inlet gas pressure is too low. 	<ol style="list-style-type: none"> 1. Clean burner orifice (see <u>Care and Maintenance</u>, page 18). 2. Contact local gas supplier.
Delayed ignition of burner(s).	<ol style="list-style-type: none"> 1. Manifold pressure is too low. 2. Burner orifice is clogged. 	<ol style="list-style-type: none"> 1. Contact local gas supplier. 2. Clean burner (see <u>Care and Maintenance</u>, page 18).
Burner backfiring during combustion.	<ol style="list-style-type: none"> 1. Burner orifice is clogged or damaged. 2. Burner is damaged. 3. Gas regulator is damaged. 	<ol style="list-style-type: none"> 1. Clean burner orifice (see <u>Care and Maintenance</u>, page 18). 2. Replace burner. 3. Replace gas regulator.
Yellow flame during burner combustion.	<ol style="list-style-type: none"> 1. Not enough air. 2. Gas regulator is defective. 3. Inlet gas pressure is too low. 	<ol style="list-style-type: none"> 1. Check burner for dirt and debris. If found, clean burner (see <u>Care and Maintenance</u>, page 18). 2. Replace gas regulator. 3. Contact local propane/LP gas company.
Gas odor during combustion.	<ol style="list-style-type: none"> 1. Foreign matter between control valve and burner. 2. Gas leak. (See <u>Warning Statement</u> at top of page 19). 	<ol style="list-style-type: none"> 1. Take apart gas tubing and remove foreign matter. 2. Locate and correct all leaks (see <u>Checking Gas Connections</u>, page 13).

TROUBLESHOOTING

Problem	Possible Cause	Corrective Action
Slight smoke or odor during initial operation.	1. Residues from manufacturing process.	1. Problem will stop after a few hours of operation.
Heater produces a clicking/ticking noise just after burner is lit or shut off.	1. Metal is expanding while heating or contracting while cooling.	1. This is common with most heaters. If noise is excessive, contact qualified service technician.
White powder residue forming within burner box or on adjacent walls or furniture.	1. When heated, the vapors from furniture polish, wax, carpet cleaners, etc., turn into white powder residue.	1. Turn heater off when using furniture polish, wax, carpet cleaner or similar products.
Heater produces unwanted odors.	<ol style="list-style-type: none"> 1. Heater is burning vapors from paint, hair spray, glues, etc. See IMPORTANT statement, page 19. 2. Gas leak. See <i>Warning Statement</i> at the top of page 19. 3. Low fuel supply (propane/LP gas only). 	<ol style="list-style-type: none"> 1. Ventilate room. Stop using odor causing products while heater is running. 2. Locate and correct all leaks (see <u><i>Checking Gas Connections</i></u>, page 13). 3. Refill supply tank (Propane/LP models).
Heater shuts off in use (ODS operates).	<ol style="list-style-type: none"> 1. Not enough fresh air is available. 2. Low line pressure. 3. ODS/pilot is partially clogged. 	<ol style="list-style-type: none"> 1. Open window and/or door for ventilation. 2. Contact local gas supplier. 3. Clean ODS/pilot (see <u><i>Care and Maintenance</i></u>, page 18).
Gas odor exists even when control knob is in OFF position.	<ol style="list-style-type: none"> 1. Gas leak. See <i>Warning Statement</i> at top of page 19. 2. Control valve is defective. 	<ol style="list-style-type: none"> 1. Locate and correct all leaks (see <u><i>Checking Gas Connections</i></u>, page 13). 2. Replace control valve.
Moisture/condensation noticed on windows.	1. Not enough combustion/ventilation air.	1. Refer to <u><i>Air for Combustion and Ventilation</i></u> requirements, page 7.

PARTS

MODEL ML060HBA

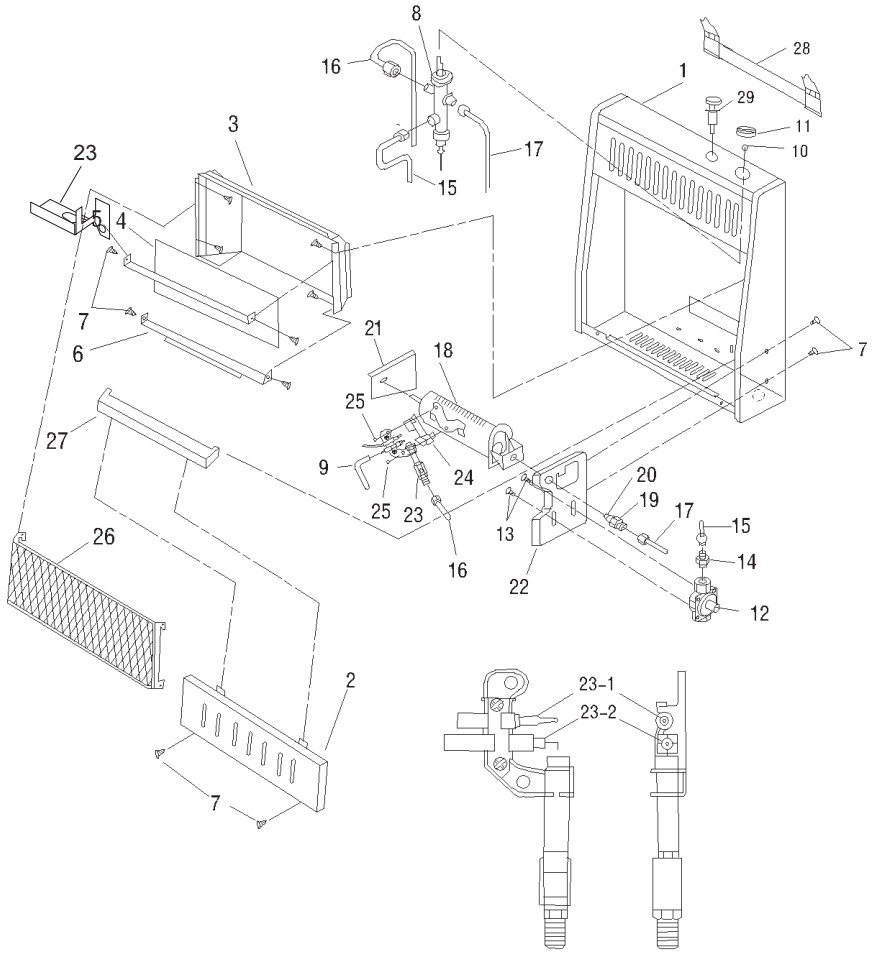

ODS/Pilot Assembly

PARTS

MODEL ML060HBA

This list contains replaceable parts for your heater. When ordering replacement parts, follow the instructions listed under Replacement Parts on page 28 of this manual.

ITEM	PART #	DESCRIPTION	QTY
1	**MB10008	Cabinet Assembly	1
2	MB09003	Lower Front Panel	1
3	**MB11005	Reflector Unit	1
4	ML086-03	Glass	1
5	ML087-03	Upper Glass Retainer	1
6	ML088-03	Lower Glass Retainer	1
7	**ML069-02	Self Tapping Screw	12
8	NV2020-12	Control Valve	1
9	ML073-02	Ignitor Cable	1
10	ML029-01	Control Valve Fixed Nut	1
11	ML031-03	Control Knob	1
12	**RV81FI-8	Pressure Regulator	1
13	**ML079-01	Self Locking Screw	2
14	**ML119-01	Pressure Tap	1
15	**MB40033	Main Inlet Tube Assembly	1
16	**MB40045	ODS Line Assembly	1
17	**MB40043	Gas Outlet Tube Assembly	1
18	**NBB06-000M1	Burner	1
19	**ML101-02	Burner Connector	1
20	**ML091-11	Injector	1
21	**ML103-02	Left Burner Support Bracket	1
22	**ML129-02	Regulator Mounting Bracket	1
23	ND1308X600	ODS/Pilot Assembly	1
23-1	ND0803-6	Thermocouple	1
23-2	ND0807	Ignitor Electrode	1
24	**ML105-02	ODS Deflector	1
25	**6170-5Z	Nut	2
26	MB29003	Grill Guard	1
27	**ML084-03	Middle Panel	1
28	161132-01	Mounting Bracket	1
29	ML083-03	Ignitor	1
PARTS AVAILABLE - NOT SHOWN			
	161607-01	Hardware Package	1

**Not a field replacement part.

PARTS

MODEL ML100HBA

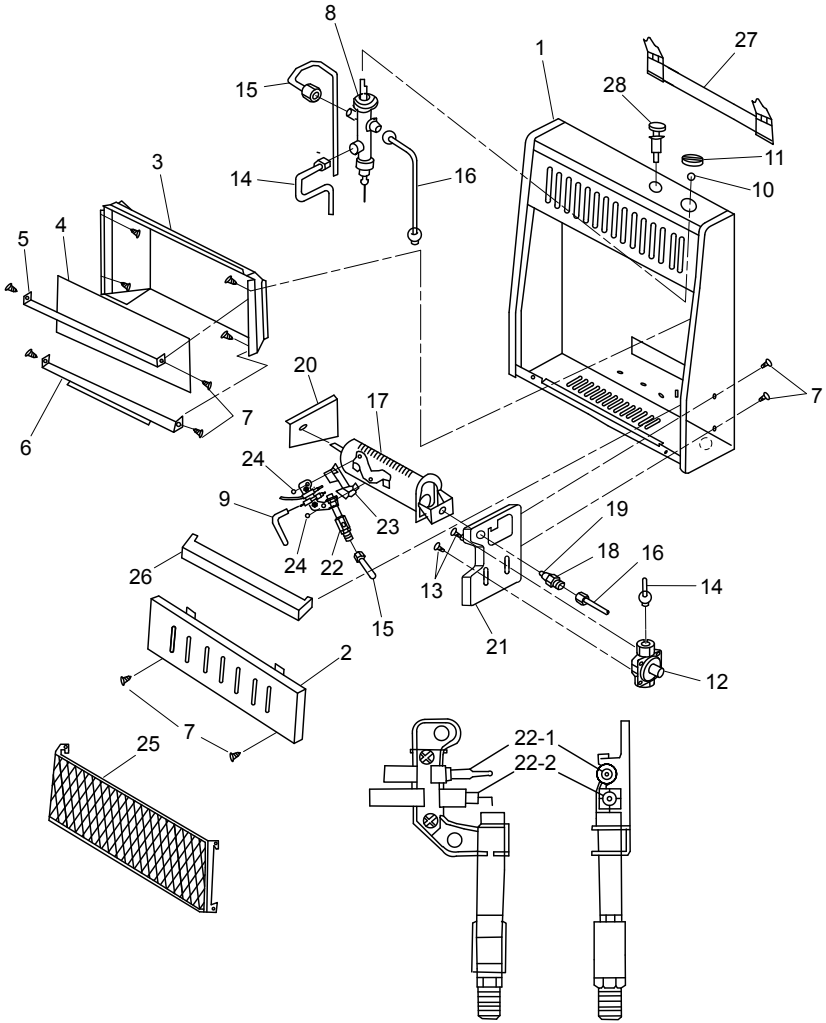

ODS Pilot Assembly

PARTS

MODEL ML100HBA

This list contains replaceable parts for your heater. When ordering replacement parts, follow the instructions listed under Replacement Parts on page 28 of this manual.

ITEM	PART #	DESCRIPTION	QTY
1	**MB10008	Cabinet Assembly	1
2	MB09003	Lower Front Panel	1
3	**MB11005	Reflector Unit	1
4	ML086-03	Glass	1
5	ML087-03	Upper Glass Retainer	1
6	ML088-03	Lower Glass Retainer	1
7	**ML069-02	Self Tapping Screw	12
8	NV2020-1209	Control Valve	1
9	ML073-02	Ignitor Cable	2
10	ML029-01	Control Valve Fixed Nut	1
11	ML031-03	Control Knob	1
12	**RV81FI-8	Pressure Regulator	1
13	**ML079-01	Self Locking Screw	2
14	**MB40034A	Main Inlet Tube Assembly	1
15	**MB40056	ODS Line Assembly	1
16	**MB40054	Gas Outlet Tube Assembly	1
17	**NBB10-000M2	Burner	1
18	**ML101-01	Burner Connector	1
19	**ML091-10	Injector	1
20	**ML103-02	Left Burner Support Bracket	1
21	**ML129-02	Regulator Mounting Bracket	1
22	ND1308X600	ODS/pilot	1
22-1	ND0803-6	Thermocouple	1
22-2	ND0807	Ignitor Electrode	1
23	**ML105-02	ODS Deflector	1
24	**6170-5Z	Nut	2
25	MB29003	Grill Guard	1
26	**ML084-03	Middle Panel	1
27	161132-01	Mounting Bracket	1
28	ML083-03	Ignitor	1
PARTS AVAILABLE - NOT SHOWN			
	161607-01	Hardware Package	1

**Not a field replacement part.

PARTS

MODEL ML100TBA

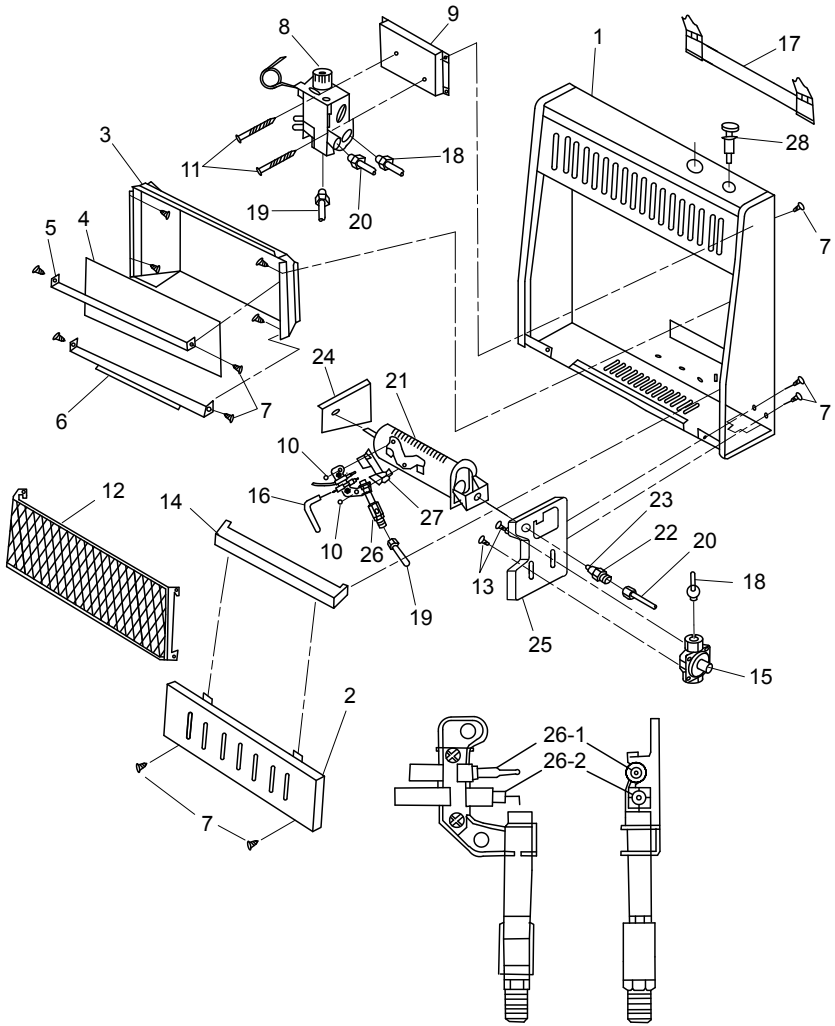

ODS Pilot Assembly

PARTS

MODEL ML100TBA

This list contains replaceable parts for your heater. When ordering replacement parts, follow the instructions listed under Replacement Parts on page 28 of this manual.

ITEM	PART #	DESCRIPTION	QTY
1	**MB10007	Cabinet Assembly	1
2	MB09003	Lower Front Panel	1
3	**MB11005	Reflector Unit	1
4	ML086-03	Glass	1
5	ML087-03	Upper Glass Retainer	1
6	ML088-03	Lower Glass Retainer	1
7	**ML069-02	Self Tapping Screw	12
8	161130-01	Thermostat Valve Assembly	1
9	**ML111-02	Thermostat Valve Base/Bracket	1
10	**6170-5Z	Nut	2
11	**845-4.8x60Z	Screws	2
12	MB29003	Grill Guard	1
13	**ML079-01	Self Locking Screw	2
14	**ML084-03	Middle Panel	1
15	**RV81FI-8	Pressure Regulator	1
16	ML073-02	Ignitor Cable	1
17	161132-01	Mounting Bracket	1
18	**MB40037	Main Inlet Tube Assembly	1
19	**MB40049	ODS Line Assembly	1
20	**MB40050	Burner Inlet Tube Assembly	1
21	**NBB10-000M2	Burner	1
22	**ML101-01	Burner Connector	1
23	**ML091-10	Injector	1
24	**ML103-02	Left Burner Support Bracket	1
25	**ML129-02	Regulator Mounting Bracket	1
26	ND1308x800	ODS/Pilot	1
26-1	ND0803-8	Thermocouple	1
26-2	ND0807	Ignitor Electrode	1
27	**ML105-02	ODS Deflector	1
28	ML083-03	Ignitor	1
PARTS AVAILABLE - NOT SHOWN			
	161607-01	Hardware Package	1

**Not a field replacement part.

REPLACEMENT PARTS

Note: Use only original replacement parts. This will protect your warranty coverage for parts replaced under warranty.

PARTS UNDER WARRANTY

Contact authorized dealers of this product. If they can't supply original replacement parts, call Customer Service toll free at 1-866-573-0674 for referral information.

When calling Customer Service or your dealer, have ready:

- Your name
- Your address
- Model and serial number of your heater
- How heater was malfunctioning
- Type of gas used (Propane/LP or Natural gas/NG)
- Purchase date

Usually, we will ask you to return the defective part to the factory

PARTS NOT UNDER WARRANTY

Contact authorized dealers of this product. If they can't supply original replacement part(s) call Customer Service toll free at 1-866-573-0674 for referral information.

When calling Customer Service have ready:

- Model number of your heater
- The replacement part number

ACCESSORIES

Purchase these heater accessories from your local dealer. If they can not supply these accessories, contact ProCom Heating, Inc. at 1-866-573-0674 for information.

EQUIPMENT SHUTOFF VALVE

For all models. Equipment shutoff valve with 1/8" NPT tap.

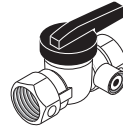

FLOOR MOUNTING STAND

PF09B For locating heater on the floor, away from a wall. Complete installation instructions provided with floor mounting stand.

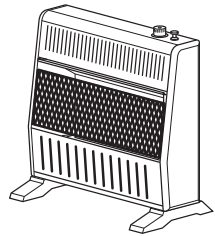

SERVICE HINTS

When Gas Pressure Is Too Low

- pilot will not stay lit
 - burners will have delayed ignition
 - fireplace will not produce specified heat
- propane/LP gas supply might be low (propane/LP units only)
- You may feel your gas pressure is too low. If so, contact your local gas supplier.

TECHNICAL SERVICE

You may have further questions about installation, operation, or troubleshooting. If so, contact ProCom Heating, Inc. at 1-866-573-0674.

When calling, please have your model and serial numbers of your heater ready.

WARRANTY

KEEP THIS WARRANTY

Model _____

Serial No. _____

Date Purchased _____

Keep receipt for warranty verification.

REGISTER YOUR PRODUCT AT WWW.USAPROCOM.COM

IMPORTANT: We urge you to register your product within 10 days of date of installation, complete with entire serial number which can be found on the rating plate. Please fill out the warranty information above for your personal records. Retain this manual for future reference.

Always specify model and serial numbers when communicating with customer service.

We reserve the right to amend these specifications at any time without notice. The only warranty applicable is our standard written warranty. We make no other warranty, expressed or implied.

LIMITED WARRANTY

ProCom Heating, Inc. warrants this product to be free from defects in materials and components for ONE (1) year from the date of first purchase, provided that the product has been properly installed by a qualified installer in accordance with all local codes and instructions furnished with the unit, operated and maintained in accordance with all applicable instructions. To make a claim under this warranty, the Bill of Sale or cancelled check must be presented.

RESPONSIBILITY OF OWNER

This warranty is extended only to the original retail purchaser. This warranty covers the cost of part(s) required to restore this heater to proper operating condition. Warranty part(s) MUST be obtained through ProCom Heating, Inc. who will provide original factory replacement parts. Failure to use original factory replacement parts voids this warranty.

IMPORTANT: The heater MUST be installed by a qualified installer in accordance with all local codes and instructions furnished with the unit or the warranty is voided.

WHAT IS NOT COVERED

This warranty does not apply to parts that are not in original condition because of normal wear and tear or parts that fail or become damaged as a result of misuse, accidents, lack of proper maintenance or defects caused by improper installation. Travel, diagnostic cost, labor, transportation and any and all such other costs related to repairing a defective heater will be the responsibility of the owner.

TO THE FULL EXTENT ALLOWED BY THE LAW OF THE JURISDICTION THAT GOVERNS THE SALE OF THE PRODUCT, THIS EXPRESS WARRANTY EXCLUDES ANY AND ALL OTHER EXPRESSED WARRANTIES AND LIMITS THE DURATION OF ANY AND ALL IMPLIED WARRANTIES. INCLUDING WARRANTIES OF MERCHANTABILITY AND FITNESS FOR A PARTICULAR PURPOSE TO ONE (1) YEAR ON ALL COMPONENTS FROM THE DATE OF FIRST PURCHASE. PROCOM HEATING, INC.'S LIABILITY IS HEREBY LIMITED TO THE PURCHASE PRICE OF THE PRODUCT AND PROCOM HEATING, INC. SHALL NOT BE LIABLE FOR ANY OTHER DAMAGES WHATSOEVER INCLUDING INDIRECT, INCIDENTAL OR CONSEQUENTIAL DAMAGES.

Some states do not allow a limitation on how long an implied warranty lasts or an exclusion or limitation of accidental or consequential damages, the above limitation on implied warranties, or exclusion or limitation on damages may not apply to you.

This warranty gives you specific legal right, and you may also have other rights that vary from state to state.



ProCom Heating, Inc.
Bowling Green, KY 42101
www.usaprocom.com
1-866-573-0674

200051-01
Rev. B
01/17