

PIPE DECOR 365 DK40

THANK YOU SO MUCH FOR PURCHASING A PIPE DECOR PRODUCT. IF YOU HAVE ANY TROUBLE PUTTING YOUR KIT TOGETHER OR MISSING PIECES PLEASE CONTACT HELP@PIPE-DECOR.COM FOR ANY HELP AND RETURNS.

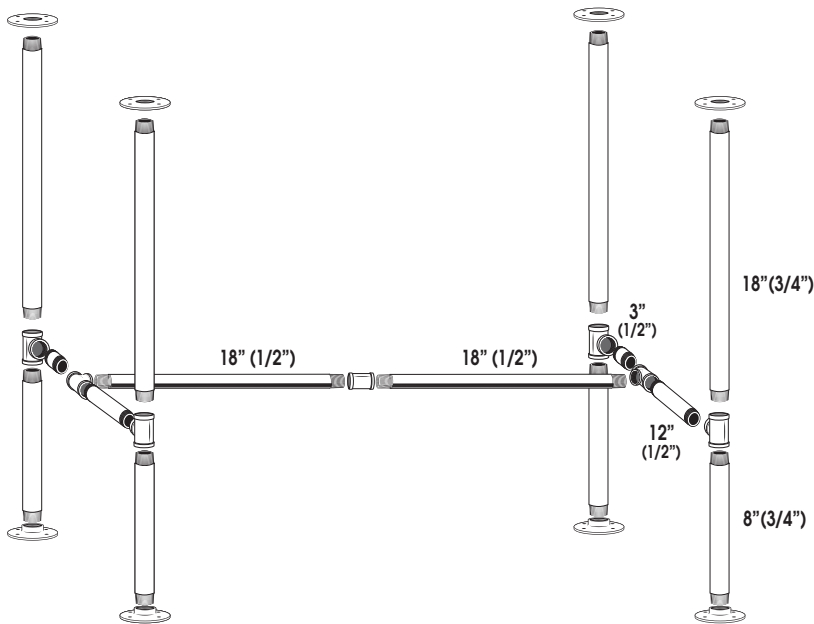

This kit is made of industrial grade authentic pipe. It is coated in oil post production to prevent rust. The kit should be cleaned and sealed to prevent rusting. See Clean and Seal sheet for more information on cleaning and sealing your pipe kit.

1. Connect 2 X 18" PIPE(H), 1 X COUPLING (I), 2 X TEES, as shown in box 1.

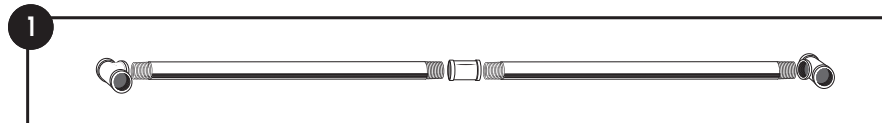

2. Connect 1 X 3" (F) PIPE, 1 X 12" PIPE (E), and 2 X R-TEES to each side, as shown in box 2.

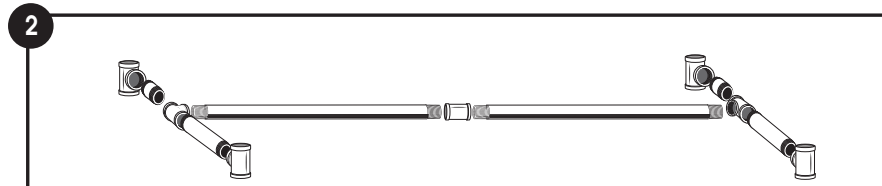

3. Connect 1 X 8" (3/4) PIPE (B) , 1 X 18" (3/4) PIPE (D), and 2 X FLANGES to each legs.

4. Loosen or tighten flanges to level table, and screw into table top.

Flanges may scratch floor and pads are recommended.

A - 8 X FLANGES

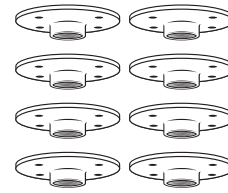

B - 4 X 8" PIPE(3/4")



C - 4 X R-TEES

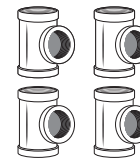

D - 4 X 18" PIPE(3/4")

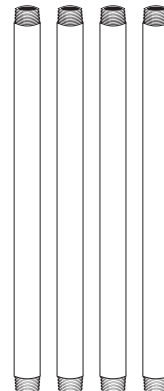

E - 2 X 12" PIPE(1/2")



F - 2 X 3" PIPE(1/2")



G - 2 X TEES



H - 2 X 18" PIPE (1/2")



I - 1 X COUPLING



J - 16 X 3/4" SCREWS

RECOMMENDED TOOLS

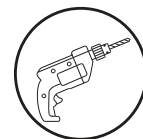

RECOMMENDED
FOR ATTACHING LEGS
TO TABLE TOP