

PIPE DECOR 365 2TIER

THANK YOU SO MUCH FOR PURCHASING A PIPE DECOR PRODUCT. IF YOU HAVE ANY TROUBLE PUTTING YOUR KIT TOGETHER OR MISSING PIECES PLEASE CONTACT HELP@PIPE-DECOR.COM FOR ANY HELP AND RETURNS.

365 2TIER

Parts List:

- A** - 1/2" FLANGE (6 PCS)
- B** - 1/2" X 6" CONNECTOR (2 PCS)
- C** - 1/2" X 12" CONNECTOR (8 PCS)
- D** - 1/2" ELBOW (4 PCS)
- E** - 1/2" TEE (2 PCS)
- F** - #10 X 1-3/4" SCREWS (24 PCS)
- G** - PLASTIC WALL ANCHORS (24 PCS) NOTE: Use wall anchors for hollow wall application only. Wall anchors are not necessary if flanges are attached directly to studs.

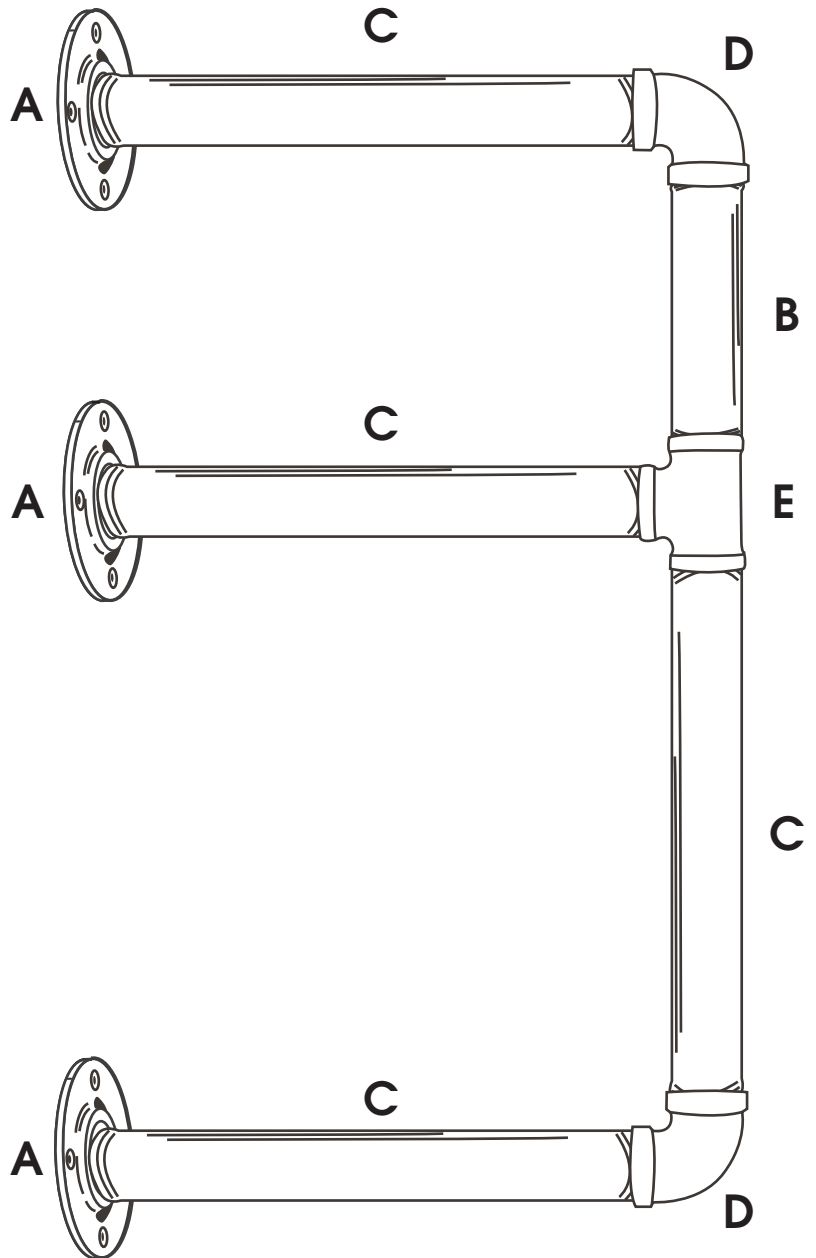

INSTALLATION:

NOTE: For best results, tiered shelf should be installed into a stud.

1. Assemble the shelf bracket as shown in the picture. Hand tighten all connections. be sure that all flange holes are in the 12:00, 3:00, 6:00 and 9:00 position.

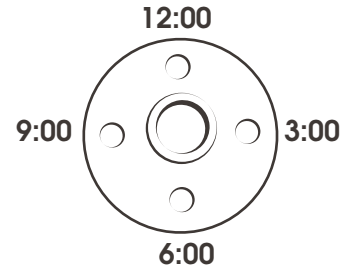

2. Set the assembled brackets side by side with the face of the flanges on a smooth, flat surface. See figure to the right. Make sure all flanges line up evenly side by side, this will help to assure your shelves on both sides are even. If flanges do not line up, adjust pipe accordingly by tightening or loosening.

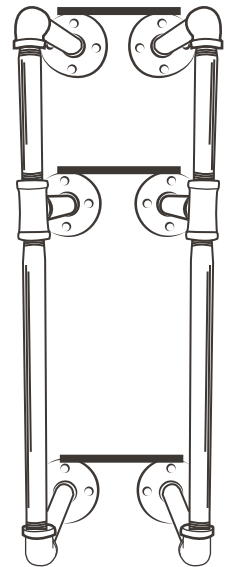

3. Make sure all flange faces are touching the flat surface evenly, this will assure that there are no gaps between any of the flanges on the wall. If flanges are not touching flat surface evenly, adjust accordingly by tightening or loosening flanges.

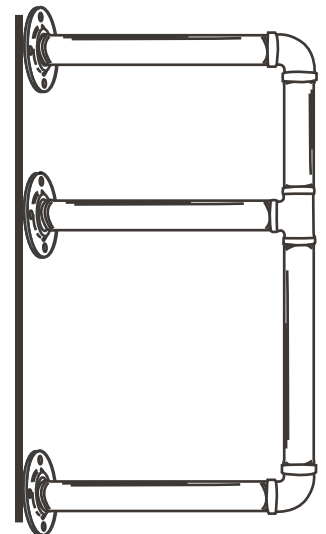

4. It is strongly recommended that the brackets are fastened to wall studs or a wood/metal backing plate. Studs are 1 1/2" wide and are generally located 16" apart, so the bracket assemblies need to be either 16" or 32" apart. Locate and mark the center of the studs with a stud finder (not included).

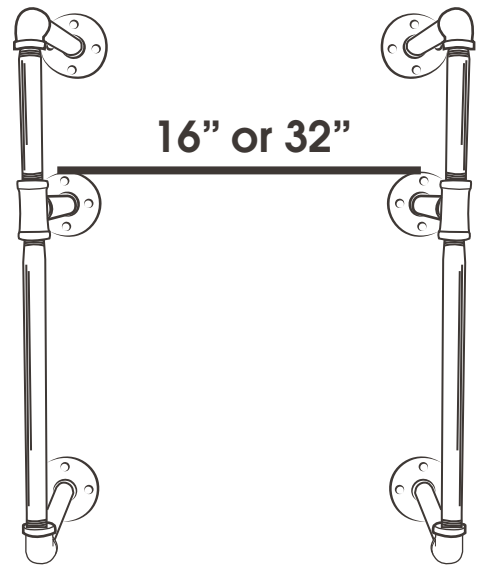

5. Place a bracket assembly against the wall in the desired location, with the top hole of the flange set in the center of the stud. Mark the hole with a pencil. Now mark the bottom hole of the bottom flange. Place a level between the top mark and the bottom mark. Adjust position of the bottom mark so it is vertically level with the top hole mark.

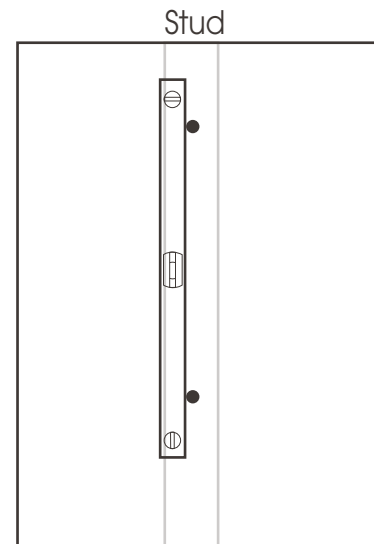

6. Using a 2' or 4' level, mark the top hole for the other bracket assembly in the center of the stud where it will be installed. This mark needs to be level with the first top hole mark. Mark the bottom hole the same way; level with the first bottom hole mark.

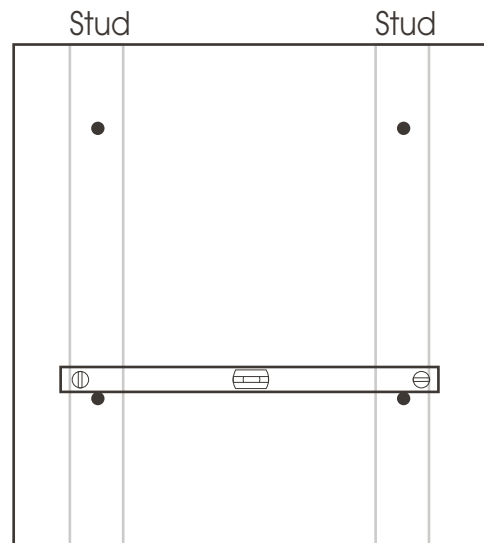

7. Hold the bracket assembly against the wall with the top and bottom mark lined up in the flange holes. Mark the remaining flange holes with a pencil. (NOTE: It is mandatory to use all 12:00 and 6:00 positioned flange holes to attach bracket to studs).

8. Drill a 1/8" pilot hole for all center hole marks (12:00 and 6:00 positions). Using a screwdriver (not included), screw the anchors into the 3:00 and 9:00 positioned marks. See illustration illustration for wall anchor installation.

***Wall Anchor Installation**

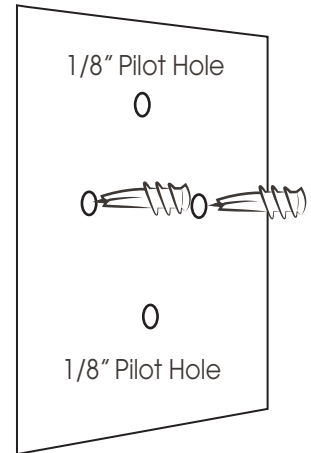
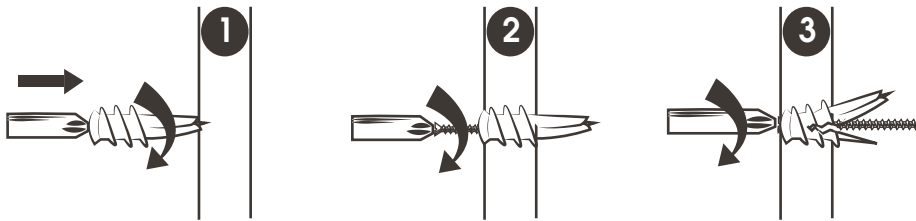

9. Install fully assembled bracket assemblies onto the wall with provided screws.