

PIPE DECOR 365 MWD30

THANK YOU SO MUCH FOR PURCHASING A PIPE DECOR PRODUCT. IF YOU HAVE ANY TROUBLE PUTTING YOUR KIT TOGETHER OR MISSING PIECES PLEASE CONTACT HELP@PIPE-DECOR.COM FOR ANY HELP AND RETURNS.

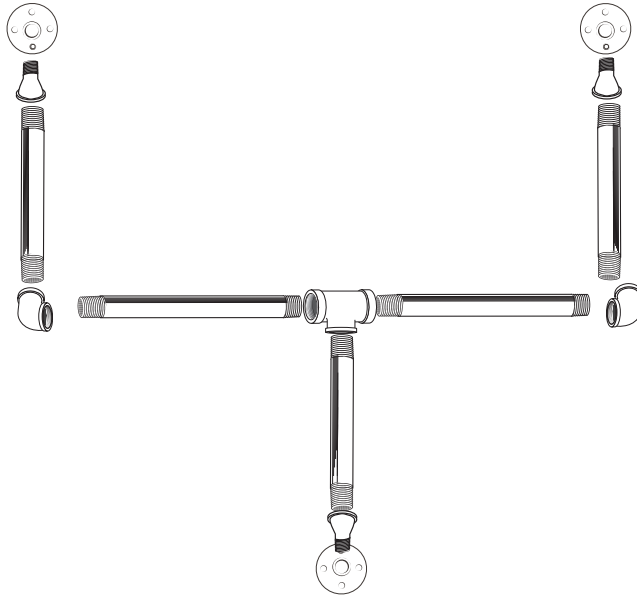

Parts List:

- A** - 1/2" FLANGE (3 PCS)
- B** - 1/2" X 12" CONNECTOR (5 PCS)
- C** - 1/2" ELBOW (2 PCS)
- D** - 1/2" TEE (1 PCS)
- E** - 1/2" X STREET ELBOW (3 PCS)
- F** - 12 X SCREWS & ANCHORS

RECOMMENDED TOOLS

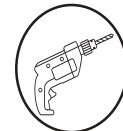

RECOMMENDED
DRILL WITH 3/16" BIT
FOR WALL ANCHOR



RECOMMENDED
STUD FINDER

THIS IS INDUSTRIAL GRADE AUTHENTIC PIPE. IT COMES COVERED IN ANTI-RUST OIL. THEY ARE DIRTY TO THE TOUCH BUT CAN BE CLEANED AND SEALED TO PREVENT RUST AND BE CLEAN TO THE TOUCH. SEE CLEAN AND SEAL SHEET FOR WAYS TO CLEAN AND SEAL THE PIPE.

50LB MAX WEIGHT LIMIT ON RACK

1. Build rack as shown above. Tighten flanges and pipes into elbows as much as you can by hand, keep the left flange slightly loose, for steps 5-6.

2. Place rack on wall. Mark the holes of your left flange.

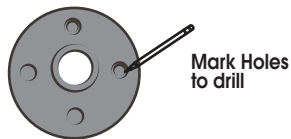

3. Pre-drill 3/16" holes at each mark you will be using anchors. Do not pre-drill if you are screwing into a stud.

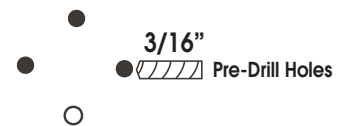

4. Screw in anchors into the pre-drilled holes. Do not over tighten.

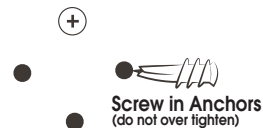

5. The left flange should be loose enough for you to move the right flange into a level position after the left flange has been screwed into the wall. Affix the left flange to the wall.

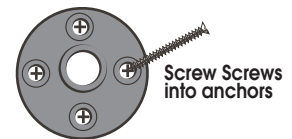

6. With the left flange installed. Rotate the rack to level the rack using a level from the top of left and right flange until level. Mark the right and lower flange holes.

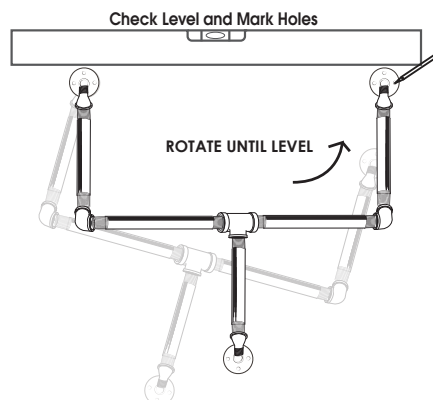

7. Repeat steps 3 - 5 on to install the rack.

8. Enjoy your new clothes rack.