

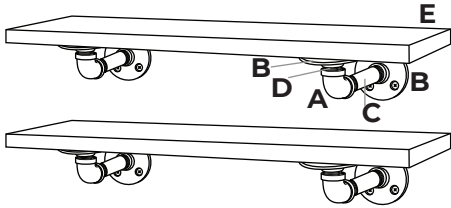



**NEED HELP OR ADVICE ON PUTTING THIS KIT TOGETHER? MISSING PIECES?
EMAIL US AT HELP@PIPE-DECOR.COM FOR ANY QUESTIONS**

24" SHELF SET

(2) 24" Shelves with (2) L-Shaped Brackets







- F  (X 16)
- G  (X 16)
- H  (X 16)

PART	DESCRIPTION - FOR 24" SHELVES	QTY
A	1/2" 90° ELBOW	4
B	1/2" FLANGES	8
C	1/2" X 4" PIPE	4
D	1/2" CLOSE PIPE	4
E	24" WOOD SHELF	2
F	WOOD SCREWS	16
G	1-3/4" SCREWS	16
H	WALL ANCHORS	16

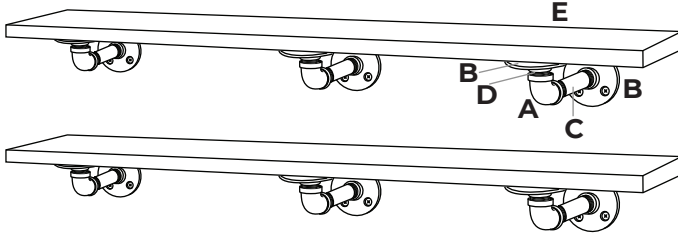
36" SHELF SET

(2) 36" Shelves with (3) L-Shaped Brackets







- F  (X 24)
- G  (X 24)
- H  (X 24)

PART	DESCRIPTION - FOR 36" SHELVES	QTY
A	1/2" 90° ELBOW	6
B	1/2" FLANGES	12
C	1/2" X 4" PIPE	6
D	1/2" CLOSE PIPE	6
E	36" WOOD SHELF	2
F	WOOD SCREWS	24
G	1-3/4" SCREWS	24
H	WALL ANCHORS	24

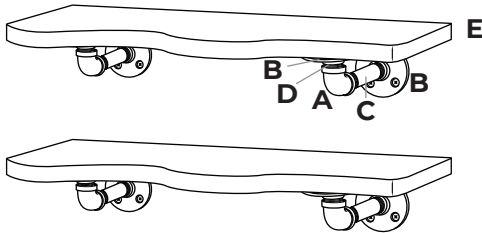
24" LIVE EDGE SHELF SET

(2) 24" Shelves with (2) L-Shaped Brackets







- F  (X 16)
- G  (X 16)
- H  (X 16)

PART	DESCRIPTION - FOR 24" LIVE EDGE SHELVES	QTY
A	1/2" 90° ELBOW	4
B	1/2" FLANGES	8
C	1/2" X 4" PIPE	4
D	1/2" CLOSE PIPE	4
E	24" LIVE EDGE WOOD SHELF	2
F	WOOD SCREWS	16
G	1-3/4" SCREWS	16
H	WALL ANCHORS	16

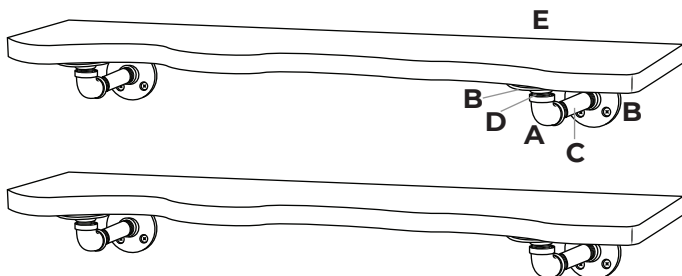
36" LIVE EDGE SHELF SET

(2) 36" Shelves with (2) L-Shaped Brackets



- F  (X 16)
- G  (X 16)
- H  (X 16)

PART	DESCRIPTION - FOR 36" LIVE EDGE SHELVES	QTY
A	1/2" 90° ELBOW	4
B	1/2" FLANGES	8
C	1/2" X 4" PIPE	4
D	1/2" CLOSE PIPE	4
E	36" LIVE EDGE WOOD SHELF	2
F	WOOD SCREWS	16
G	1-3/4" SCREWS	16
H	WALL ANCHORS	16

EASY INSTALLATION:

RECOMMENDED TOOLS FOR INSTALLATION

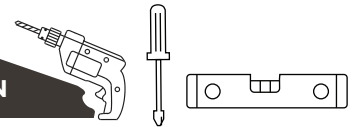

1. Assemble the brackets as shown in Figure 1. Hand tighten each piece.
2. Attach brackets to the wall (See Figure 2)

A) Using stud finder, locate and mark wall stud

1. Place flange against wall in desired location and mark holes with pencil
2. Attach flange to wall with included screws

B) If no wall stud is present

1. Place flange against wall in desired location and mark holes with pencil
2. Drill pilot holes in wall using 1/4" drill bit
3. Insert anchor fully into pilot hole using hammer and Phillips screwdriver as needed
4. Attach flange to wall using included screws.

3. Using a drill, screw the top of the bracket into the shelf as shown in Figure 3.
We recommend using setting #10 to prevent stripping the wood. There is no need to pre-drill.

FIGURE 1

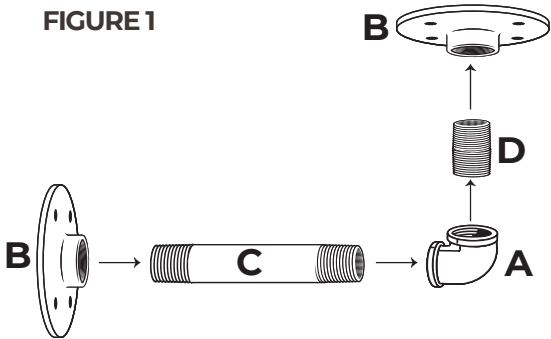

FIGURE 2

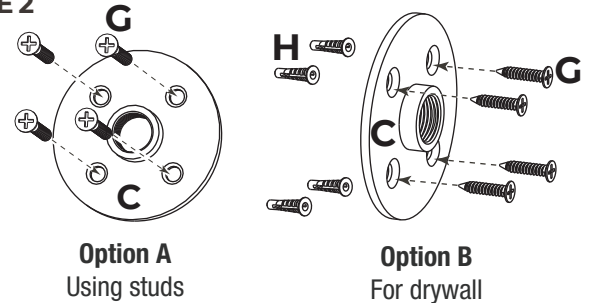
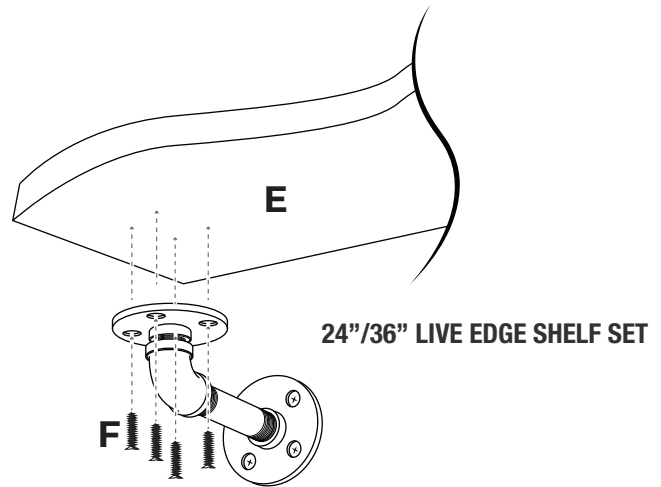
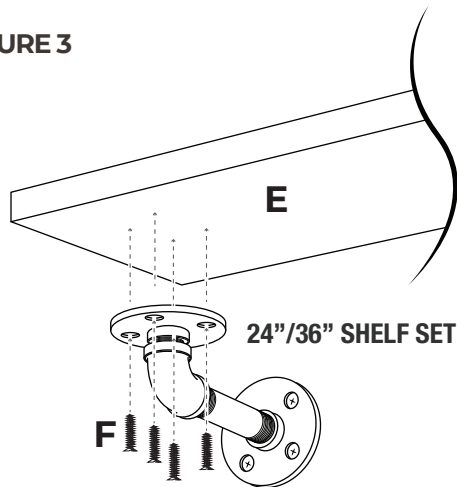

FIGURE 3



HOW TO PREVENT PIPE CORROSION

PIPE DECOR industrial-grade black pipes and fittings are coated with a rust-preventive oil during manufacturing. For best results, **SEAL THE PIPES TO AVOID ANY RUSTING** after cleaning the kit.

CLEAN AND SEAL INSTRUCTIONS:

Recommended supplies: regular degreasing dish soap, washcloths, gloves (optional)

1. Wash your pipes and fittings with warm water and dish soap until the oil is completely removed.
2. Wipe the pipes with a dry washcloth and wait until the pipes are completely dry.

IMPORTANT: THE PIPES MUST BE COMPLETELY DRY BEFORE YOU START THE SEALING PROCESS.

SEALING WITH POLYURETHANE SPRAY:

Spray each dry pipe and fitting with a polyurethane matte or satin finishing spray and let it dry before assembling the kit.

SEALING WITH FINISHING WAX:

Coat each dry pipe with a finishing wax. Wait for 20 minutes, then polish the pipe with a dry washcloth by wiping them down. Faster wiping will result in a shinier finish.